

Klucze i wkrętaki

Wrenches and screwdrivers

Ключи и отвертки

NEO  
TOOLS

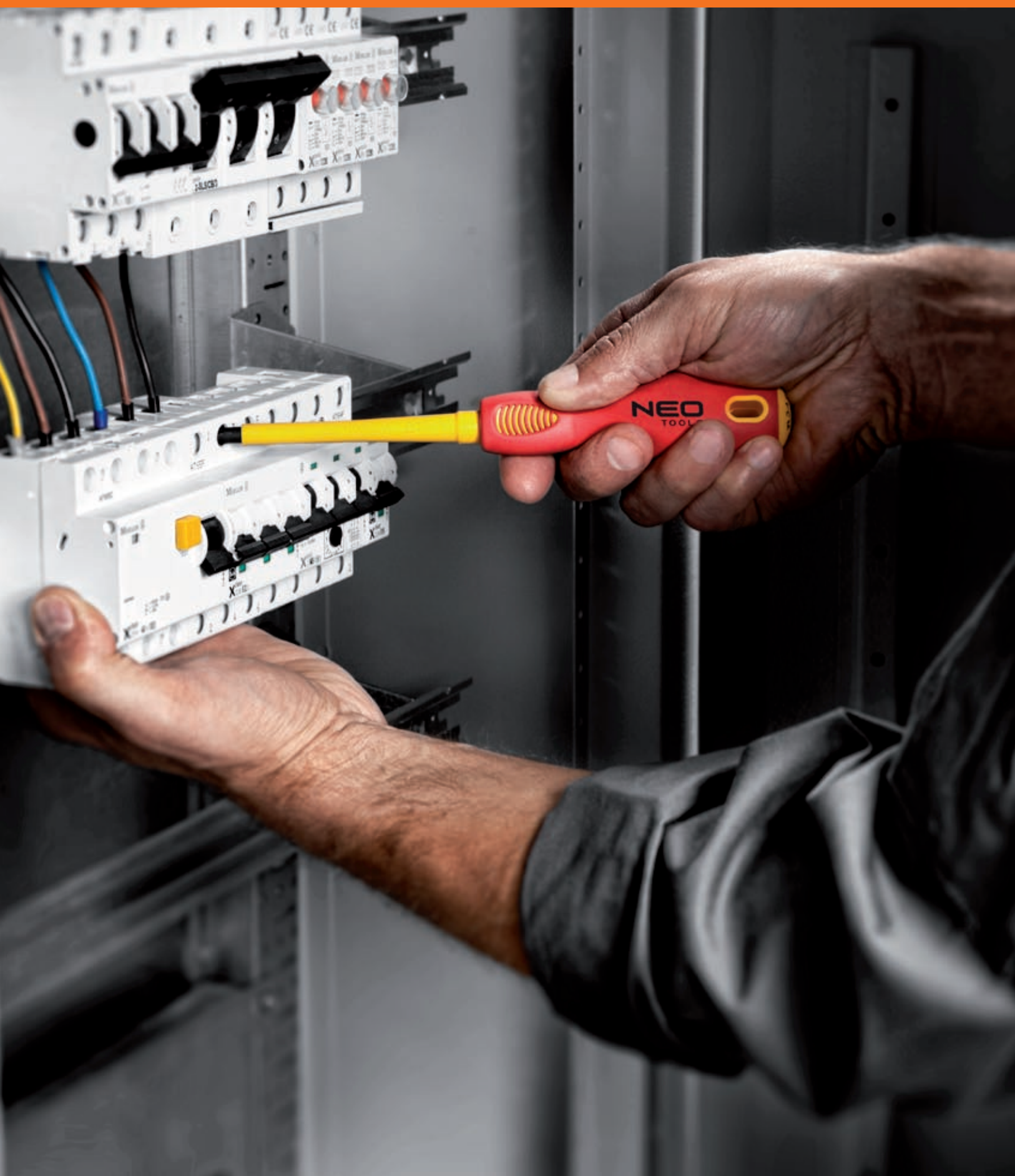

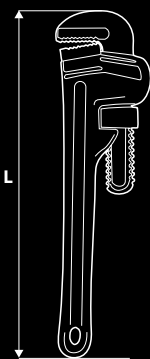

25  
years  
guarantee

### Klucz do rur stillson

Stillson pipe wrench / Rohrschlüssel stillson / Ключ трубный stillson / „Stillson” csőfogó / Cheie reglabila pentru tevi / Kleště trubkové Stillson / Ključ na rúry stillson / Ključ za cevi stillson / Raktas vamzdžiams „Stillson” / Čauruļu atslēga / Stillson-toruvõti / Тръбен ключ stillson / Ključ za cijevi stillson / Ključ za cevi stillson / Σωληνοκάβουρας τύπου Stillson / Llave stillson / Chiave giratubi Stillson / Chave p. Tubos stillson / Clef pour tubes stillson / Sleutel voor stillsonbuizen



- szczęki odkuwane i szlifowane ze stali stopowej
- korpus z żeliwa ciągliwego
- podziałka do ustawiania żądanej średnicy rury
- alloy steel jaws, forged and grinded
- body of malleable cast iron
- scale for setting required pipe diameter
- кованные, шлифованные губки из легированной стали
- корпус из ковкого чугуна
- шкала для регулировки диаметра трубы

Ref.	L[mm]	m[kg]	📦	📦	EAN
02-103	250/10	0,8	6	36	5907558404012
02-104	300/12	1,1	6	24	5907558404029
02-105	350/14	1,6	6	12	5907558404036



25  
years  
guarantee

### Klucz do rur stillson odgięty

Offset Stillson pipe wrench / Rohrschlüssel stillson, gebogen / Ключ трубный stillson изогнутый / Ключ трубный «Stillson», вигнутий / „Stillson” hajlított csőfogó / Cheie reglabila pentru tevi-priza exterioara / Kleště trubkové Stillson vyhnuté / Ključ na rúry stillson zahnutý / Ključ za cevi stillson odviti / Raktas vamzdžiams „Stillson”, lenktas / Izliekta čauruļu atslēga / Kõvera otsaga stillson-toruvõti / Тръбен ключ stillson отгънат / Ključ za cijevi stillson odvinuti / Ključ za cevi stillson obrnuti / Σωληνοκάβουρας τύπου Stillson κυρτός / Llave stillson curva / Chiave giratubi Stillson curva / Chave p. tubos stillson curvada / Clef pour tubes contre-coudée / Sleutel voor stillsonbuizen gebogen



- szczęki odkuwane i szlifowane ze stali stopowej
- korpus z żeliwa ciągliwego
- podziałka do ustawiania żądanej średnicy rury
- alloy steel jaws, forged and grinded
- body of malleable cast iron
- scale for setting required pipe diameter
- кованные, шлифованные губки из легированной стали
- корпус из ковкого чугуна
- шкала для регулировки диаметра трубы

Ref.	L[mm]	m[kg]	📦	📦	EAN
02-113	250/10	0,8	6	36	5907558404043
02-114	300/12	1,3	6	12	5907558404050

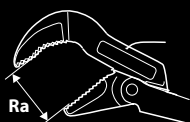

DIN  
5234

CrV  
steel

25  
years  
guarantee

### Klucz do rur typ „S”

S-type pipe wrench / Rohrschlüssel Typ „S” / Ключ трубный S-образный / Ключ трубный, тип «S» / Svéd csőfogó / Cheie reglabila pentru tevi, tip „S” / Kleště trubkové „S” / Ključ na rúry typ „S” / Ključ za cevi tipa „S” / Raktas „S” tipo vamzdžiams / S-tipa čauruļu atslēga / S-tüüpi toruvõti / Тръбен ключ тип „S” / Ključ za cijevi tip „S” / Ključ za cevi tipa „S” / Σωληνοκάβουρας τύπου S / Llave para tubos modelo sueco / Chiave giratubi tipo S / Chave p. tubos tipo „S” / Clef pour tubes type „S” / Sleutel voor buizen type „S”



- odkuwany
- szlifowane i polerowane szczęki
- forged
- grinded and polished jaws
- кованный
- шлифованные и полированные губки

Ref.	L[mm]	Ra [mm/"]	m[kg]	📦	📦	EAN
02-120	235	30/0.5	0,4	4	48	5907558408645
02-121	330	40/1	0,9	6	24	5907558404067
02-122	425	55/1.5	1,5	4	16	5907558404074
02-123	535	67/2	2,4	2	12	5907558404081
02-124	650	103/3	4,2	1	10	5907558405996

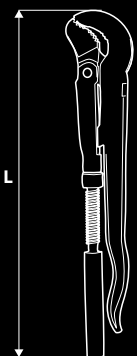

## Klucz do rur typ 45

Pipe wrench type 45 / Rohrschlüssel Typ "45" / Ключ трубный тип "45" / Ключ трубный, тип «45» / Svéd csőfogó, 45°-os / Cheie reglabila pentru țevi, tip "45" / Kleště trubkové 45 st. / Klúč na rúry typ „45“ / Kľuč za cevi tipa „45“ / Raktas „45“ tipo vamzdžiams / 45 tipa cauruļu atslēga / 45-tüüpi toruvõti / Тръбен ключ тип "45" / Kľuč za cijevi tip "45" / Kľuč za cevi tipa "45" / Σαληνοκάβουρας τύπου 45 / Llave para tubos modelo sueco "45" forma de S / Chiave giratubi a 45° / Chave p. tubos tipo "45" / Clef pour tubes type "45" / Sleutel voor buizen type "45"

DIN  
5234

CrV  
steel

25  
years  
guarantee

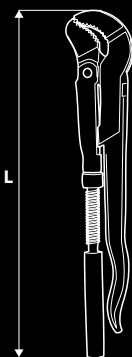

- odkuwany
- szlifowane i polerowane szczęki
- forged
- grinded and polished jaws
- кованный
- шлифованные и полированные губки

Ref.	L[mm]	Ra [mm/"]	m[kg]	☞	☞	EAN
02-125	235	30/0.5	0,4	4	48	5907558406009
02-126	330	40/1	0,8	6	24	5907558406016
02-127	415	55/1.5	1,4	4	18	5907558406023
02-128	535	67/2	2,3	2	12	5907558406030

## Klucz do rur typ „90”

Pipe wrench type 90 / Rohrschlüssel Typ "90" / Ключ трубный тип "90" / Ключ трубный, тип «90» / Svéd csőfogó, 90°-os / Cheie reglabila pentru țevi, tip "90" / Kleště trubkové 90 st. / Klúč na rúry typ „90“ / Kľuč za cevi tipa „90“ / Raktas „90“ tipo vamzdžiams / 90 tipa cauruļu atslēga / 90-tüüpi toruvõti / Тръбен ключ тип "90" / Kľuč za cijevi tip "90" / Kľuč za cevi tipa "90" / Σαληνοκάβουρας τύπου 90 / Llave para tubos modelo sueco "90" / Chiave giratubi a 90° / Chave p. tubos tipo "90" / Clef pour tubes type "90" / Sleutel voor buizen type "90"

DIN  
5234

25  
years  
guarantee

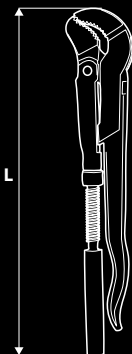
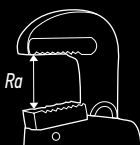

- odkuwany
- szlifowane i polerowane szczęki
- forged
- grinded and polished jaws
- кованный
- шлифованные и полированные губки

Ref.	L[mm]	Ra [mm/"]	m[kg]	☞	☞	EAN
02-130	320	40/1	0,8	6	24	5907558411478
02-131	425	55/1.5	1,3	4	16	5907558411485
02-132	560	67/2	2,2	2	12	5907558411492
02-133	630	103/3	2,9	2	10	5907558411508

## Obcinak do rur

Tube cutter / Rohrschneider / Трубкоз / Труборез / Csővágó / Dispositiv tăiere țevi / Trubkořez / Rezač rúrok / Rezalec cevi / Žirkles vamzdžiams / Caurulgriežējs / Torulõikur / Тръбоз / Rezač cijevi / Sekac za cevi / Κόπτης σωλήνων / Cortador de tubos / Tagliatubi / Cortador p. tubos / Coupe-tube / Buisknipper

∅  
35 mm

AL

Cu

25  
years  
guarantee

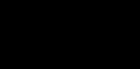
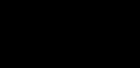
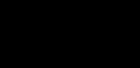
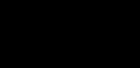

- 4 rolki prowadzące
- z gratownikiem
- zapasowe kółko tnące
- 4 guiding rollers
- with reamer
- spare cutting wheel
- 4 направляющих ролика
- с зенковкой
- запасной режущий круг

Ref.	max ø [mm]	☞	☞	EAN
02-010	35	6	36	5907558408461

### Kółko tnące

Replacement wheel / Wechsellrad / Кольцо сменное / Колесо заминне / Cseprévágó kerék / Roată rezervă / Výměnné kolečko / Koliesko náhradné do rezačky / Nadomestno kolo / Keičiamas žiedas / Asmenis flūzgriezējam / Tagavaraģatās / Резервно ножиче / Rezervni vijak / Rezervni vijak / Ανταλλακτικός τροχός / Muela de corte de repuesto / Ruota di ricambio / Roda substituível / Roue de remplacement / Vervangwiel



- do obcinaka 02-010

- for 02-010 pipecutter

- для трубореза 02-010

Ref.			EAN
02-005	40	200	5907558408973

### Obcinak do rur

Tubing cutter / Rohrabsschneider / Труборез / Труборіза / Csónágó / Dispozitiv tăiere țevi / Trubkořez / Rezač rúrok / Rezalec cevi / Žirkles vamzdažiams / Caurulgriezējs / Torulöikur / Тръборез / Rezač cijevi / Sekac za cevi / Κάπης σωλήνων / Cortador de tubos / Tagliatubi / Cortador p. tubos / Coupe-tube / Buisknipper

∅  
45 mm

PCV

PP



- dodatkowa podstawa do cięcia listew

- ergonomiczna rękojeść pokryta tworzywem TPR

- additional support for cutting slats

- ergonomic handle coated with TPR plastic

- дополнительная накладка для резки реек

- эргономичные рукоятки покрыты мягкой термопластической резиной (TPR)

Ref.	max ∅ [mm]			EAN
02-020	45	10	50	5907558408478

### Obcinak do rur

Tubing cutter / Rohrabsschneider / Труборез / Труборіза / Csónágó / Dispozitiv tăiere țevi / Trubkořez / Rezač rúrok / Rezalec cevi / Žirkles vamzdažiams / Caurulgriezējs / Torulöikur / Тръборез / Rezač cijevi / Sekac za cevi / Κάπης σωλήνων / Cortador de tubos / Tagliatubi / Cortador p. tubos / Coupe-tube / Buisknipper

AL

CU



**NEW**

Ref.	Ra ∅ [mm]			EAN
02-011	6 - 67	1	1	5907558418798

## Obcinak do rur

Tubing cutter / Rohrab Schneider / Труборез / Τρυβορισ / Csővágó / Dispozitiv tăiere țevi / Trubkořez / Rezač rúrok / Rezalec cevi / Žirkles vamzdžiams / Caurulgriežējs / Torulöikur / Τρυβορες / Rezač cijevi / Секас за цеви / Κόπτης σωλήνων / Cortador de tubos / Tagliatubi / Cortador p. tubos / Coupe-tube / Buisknipper



Ref.	Ra [mm]	Ra["]	☞	☞	EAN
02-042	10-60	1/8-2.0	1	10	5907558414332

## Obcinak do rur

Tubing cutter / Rohrab Schneider / Труборез / Τρυβορισ / Csővágó / Dispozitiv tăiere țevi / Trubkořez / Rezač rúrok / Rezalec cevi / Žirkles vamzdžiams / Caurulgriežējs / Torulöikur / Τρυβορες / Rezač cijevi / Секас за цеви / Κόπτης σωλήνων / Cortador de tubos / Tagliatubi / Cortador p. tubos / Coupe-tube / Buisknipper

25  
years  
guarantee



- 14 kółek tnących ze stali stopowej SUJ2 - 14 cutting wheels of SUJ2 steel - 14 сменных ножей из стали SUJ2

Ref.	Ra [mm]	Ra["]	☞	☞	EAN
02-040	19-83	3/4-3.1/4	10	30	5907558410006

## Kółka tnące

Cutting wheels / Schneideräder / Режущие колесики / Ролики ризальни / Vágókerekek / Rotițe tăietoare / Řezací kolečka / Rezné kolieska / Rezilna kolasa / Pjovimo diskeliai / Zāģveltnīši / Lōikeratas / Режущи колелца / Rezni kotači / Τακίτσι за резанје / Troxoi kopis / Ruedas de corte / Roda cortante / Roue de coupage / Snijwielen



- 14 kółek tnących ze stali stopowej SUJ2 - 14 cutting wheels of SUJ2 steel - 14 сменных ножей из стали SUJ2

Ref.	☞	☞	EAN
02-041	0	80	5907558410013

### Przyrząd do modelowania końcówek rur

Tubbing cutter and flaring tool set / Gerät zum Modellieren von Rohrenden / Труборез и развальцовщик, набор / Комплект інструменту до порізки та розвальцовки труб / Csővégalakító szerszám / Dispozitiv pentru modelarea pieselor de îmbinare țevilor / Zařízení na tvarování nástavců trubek / Sada nástrojov na modelovanie nástavcov rúr / Orodje za rezanje in robljenje cevi / Vamzdžij antgalij ušpaudimo ir praplėtimo įrankių rinkinys / Caurulgriežņu un cauruļu izvelmētāju komplekts / Komplekt torude lõikamiseks ja valtsimiseks / Комплект інструменту за різання і моделювання краївцят на трубах / Alat za narezivanje i modeliranje cijevi / Pribor za modelovanje krajeva cevi / Κόπτης σωλήνων και εργαλείο για διεύρυνση σωλήνων, σετ / Herramienta para amoldar las puntas de tubos / Set tagliatubi e bordatubi / Aparelho p. formar ponteiros de tubos / Outil de modelage d'embouts de tubes / Knijpgereedschap voor eindstukken



- obcinak do rur Cu i Al
- Cutter for Cu and Al pipes
- для труб Cu и Al
- zakres: 4, 4.75, 6, 8, 10, 12, 14 mm
- range: 4, 4.75, 6, 8, 10, 12, 14 mm
- рабочий диапазон: 4, 4.75, 6, 8, 10, 12, 14 мм

Ref.	Ra[mm/"]			EAN
02-050	4-14	0	12	5907558410020

### Czyścik do rur

Pipe Cleaner / Rohraußenbürste / Ерш для прочистки труб / Щітка-їоржж для труб / Csőtisztító drótkéfe / Piesa de curățire de țevi / Kartáč na čištení trubek / Čistiaca kefka na rúrky / Čistilnik cevi / Šepetyš vamzdžių išorės / Cauruļu ārējo virsmu tīrītājs / Välilimine toruhasti / Четка за външно почистване / Četka za vanjsko brušenje cijevi / Čistač za cevi / Βούρτσα καθαρισμού σωλήνων / Limpiador de tuberías / Spazzola per tubi / Pano de limpeza de tubos / Nettoyeur pour tubes / Buisreiniger

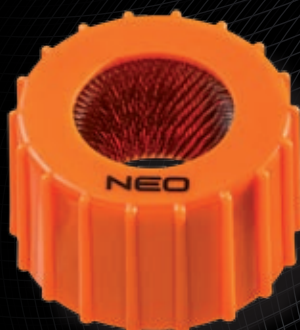

Ref.	ø [mm]			EAN
02-061	12 mm	1	1	5907558418811
02-062	15 mm	1	1	5907558418828
02-063	18 mm	1	1	5907558418835
02-064	22 mm	1	1	5907558418842
02-065	28 mm	1	1	5907558418859

### Gratownik

Trimmer / Entgrater / Зенковка для труб / Гратознімач / Sorjázó / Debaurator / Odhrotovač / Skracovačka / Sveder za cev / KIRSTUKAS vamzdžiams / Cauruļu gremdurbis / Kraatide eemaldi / Тример / Strugač za cijevi / Alat za uklanjanje opiljaka / Αλεξούρα για σωλήνες / Desbarbador de tubo / Sbovatore per tubi / Rebarbador de tubos / Ebavureur / Ruimer

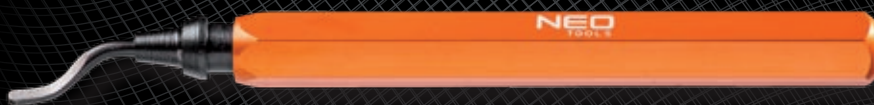

Ref.			EAN
02-066	1	1	5907558418866

**NEW**

1/2"

3/4"

**Czyścik do rur**

Pipe Cleaner / Rohraußenbürste / Ери для прочистки труб / Щітка-щорж для труб / Csőtisztító drótkéfe / Piesa de curatire de tevi / Kartáč na čištení trubek / Čistiaca kefka na rúrky / Čistilnik cevi / Šepetys vamzdžių išorės / Cauruļu ārējo virsmu tīrītājs / Válimine torupuhasti / Четка за външно почистване / Četka za vanjsko brušenje cijevi / Čistač za cevi / Βούρσα καθαρισμού σωλήνων / Limpiador de tuberías / Spazzola per tubi / Pano de limpeza de tubos / Nettoyeur pour tubes / Buisreiniger



Ref.	ø ["]	📦	📦	EAN
02-067	1/2, 3/4	1	1	5907558418880

**NEW**

1/2"

3/4"

**Czyścik do rur**

Pipe Cleaner / Rohraußenbürste / Ери для прочистки труб / Щітка-щорж для труб / Csőtisztító drótkéfe / Piesa de curatire de tevi / Kartáč na čištení trubek / Čistiaca kefka na rúrky / Čistilnik cevi / Šepetys vamzdžių išorės / Cauruļu ārējo virsmu tīrītājs / Válimine torupuhasti / Четка за външно почистване / Četka za vanjsko brušenje cijevi / Čistač za cevi / Βούρσα καθαρισμού σωλήνων / Limpiador de tuberías / Spazzola per tubi / Pano de limpeza de tubos / Nettoyeur pour tubes / Buisreiniger



Ref.	ø ["]	📦	📦	EAN
02-068	1/2, 3/4	1	1	5907558418958

**NEW****Pompka do udrażniania**

Plunger / Abflusspumpe / Прочисточный вантуз / Вантуз / Duguláselhárító pumpa / Pompa de rasuflare / Tlakový čistič trubek / Čerpadlo na čistenie potrubí / Črpalčka za odmaščevanje / Kanalizācijas pompa / Gremdvirzūļa sūkņis / Vaakumpomp / Pompa za otmuwanie / Pompa za provjeru / Pompa za otpušavanje / Αποφρακτική βεντούζα / Pistón / Pompa sturalavandini / Desentupidor de tubos / Pompe à débouchage / Gootsteenontstopper



Ref.	📦	📦	EAN
02-070	1	1	5907558418897

**NEW**



### Spirala z bębniem

Drain auger with reel / Reinigungsspirale mit Trommel / Трос сантехнический с барабаном / Трос сантехнічний з барабаном / Spirál dobba / Spirala cu tambur / Čističí spirála s bubnom / Spirála s bubnom / Spirala z bobnom / Raņķena su spirāle kanalizācijas valtūm / Sanitārtehnikā trose ar veltni / Trumliga spiraal / Спирала с барабан / uređaj za čišćenje cijevi / Spirala s bubnjem / Αποφρακτικό σπирάλ με τύλιανο περιελίξης / Muelle con tambor / Molla sturalavandini a tamburo / Serpente do canalizador com rolo / Déboucheur à tambour

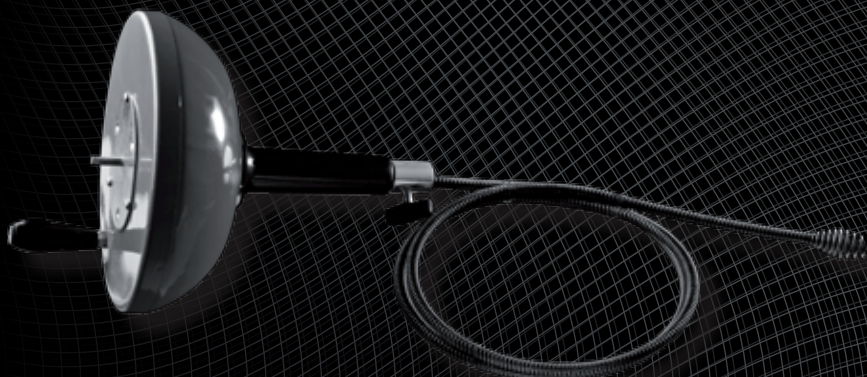

Ref.			EAN
02-071	1	1	5907558418903

**NEW**

25  
years  
guarantee

### Klucz hakowy

Power grip pipe wrench / Hackenschlüssel / Ключ-крюк / Ключ-зак / Univerzálnis csőkulcs / Cheie tevi universala / Klíč hákový / Ključ hákový / Kľukasti kľuč / Raktas-kablys / Āķa atslēga / Konksvāti / Секторен ключ / Kukasti kľuč / Kukasti kľuč / Γαλκικό κλειδί αρθρωτό / Llave de gancho articulada / Chiave a dente / Chave de anzol / Clef à crochet / Haaksleutel



Ref.	L[mm]	Ra[°]			EAN
02-140	250 mm	10	1	1	5907558418910
02-141	300 mm	12	1	1	5907558418927
02-142	355 mm	14	1	1	5907558418934

### Klucz nastawny

Adjustable wrench / Schraubenschlüssel / Ключ разводной / Ключ розвідний загвинтовий («шведік») / Alllithat csavarkulcs / Cheie reglabilă / Klíč přestavitelný / Nastavitelný kľuč / Francoski kľuč / Reguliuojamas raktas / Bīdatslēga / Tellitav vōti / Раздвижной гаечен ключ / Podesivi kľuč / Francuski kľuč / Γαλκικό κλειδί / Llave inglesa / Chiave inglese / Chave regulável / Clef à ouverture réglable / Verstelbare moersleutel



DIN  
3117

CrV  
steel

25  
years  
guarantee



- odkuwany
- większy zakres od kluczy standardowych o 10-20%
- podziałka metryczna
- odchylenie główki 22°
- forged
- 10-20% bigger than a standard wrench
- metric scale
- 22 degrees flexible end
- кований
- ширина захвата больше чем у стандартных ключей на 10-20%
- мерная шкала
- угол наклона головки 22°

Ref.	L[mm]	Ra[mm]			EAN
03-002	200	0-28.6	6	120	5907558410037
03-003	250	0-32.8	6	60	5907558410044
03-004	300	0-38.1	6	48	5907558410051

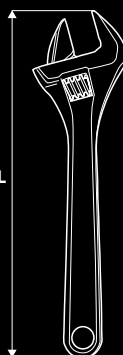

DIN  
3117CrV  
steel25  
years  
guarantee

### Klucz nastawny

Adjustable wrench / Schraubenschlüssel / Ключ разводной / Ключ розвідний заїчковий («шведик») / Állítható csavar kulcs / Cheie reglabilă / Klíč přestavitelný / Nastavitelný klúč / Francoski ključ / Reguliuojamas raktas / Bīdatslēga / Tellitav võti / Раздвижен гаечен ключ / Podesivi ključ / Francuski ključ / Γαλλικό κλειδί / Llave inglesa / Chiave inglese / Chave regulável / Clef à ouverture réglable / Verstelbare moersleutel



- odkuwany
- zakres: większy zakres od kluczy standardowych o 10-20%
- podziałka metryczna
- odchylenie główek 22°
- zaznaczony kierunek optymalnej pracy
- uchwyt pokryty tworzywem odpornym na działanie smarów i olejów

- forged
- range: 10-20% bigger than a standard wrench
- metric scale
- 22 degrees flexible end
- marked direction for optimum performance
- handle coated with plastic resistant to effects of lubricants and oils

- нованый
- ширина захвата больше чем у стандартных ключей на 10-20%
- мерная шкала
- угол наклона головки 22°
- направления для оптимальной работы
- рукоятка с покрытием, устойчивым к воздействию смазочных материалов

Ref.	L[mm]	Ra[mm]	📦	📦	EAN
03-010	150/6	0-24	6	120	5907558404111
03-011	200/8	0-28.6	6	60	5907558404128
03-012	250/10	0-32.8	6	48	5907558404135
03-013	300/12	0-38	6	24	5907558404142

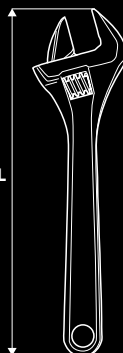
DIN  
3117CrV  
steel25  
years  
guarantee

### Klucz nastawny

Adjustable wrench / Schraubenschlüssel / Ключ разводной / Ключ розвідний заїчковий («шведик») / Állítható csavar kulcs / Cheie reglabilă / Klíč přestavitelný / Nastavitelný klúč / Francoski ključ / Reguliuojamas raktas / Bīdatslēga / Tellitav võti / Раздвижен гаечен ключ / Podesivi ključ / Francuski ključ / Γαλλικό κλειδί / Llave inglesa / Chiave inglese / Chave regulável / Clef à ouverture réglable / Verstelbare moersleutel



- większy rozstaw szczęk o 40% od standardowych kluczy 8"
- poszerzona i pocieniona głowica
- olejoodporna wykładzina rękojeści
- odkuwany
- podziałka metryczna
- odchylenie główek 22°

- 40% greater jaws range than standard 8" wrenches
- sturdier and thinner head
- handle coating resistant to oils
- forged
- metric scale
- 22 degrees flexible end

- zew більше, чем у стандартных ключей 8" на 40%
- головка шире и тоньше
- маслостойкое покрытие рукоятки
- нованый
- мерная шкала
- угол наклона головки 22°

Ref.	L[mm]	Ra[mm]	📦	📦	EAN
03-015	150	0-34	6	96	5907558412208
03-014	200	0-38	6	72	5907558404159
03-016	250	0-50	5	30	5907558412215

### Nasadka sześciokątna

Hexagonal socket / Sechskanteinsatz / Головка сменная шестигранная / Nasadka sześciokątna / 6-ları dugökulcs-betét / Cheie tubulara hexagonală / Šestihranný nástavec / Šestihranný nástavec / Šestkotni natični nastavek / Šešakampis antgalis / Sešstūra nomaiņamā galva / Kuuskantpadrun / Шестьугольная наставка / Šesterokutna kapica / Šestougaona nasadka / Καρυδάκι εξαγώνιο / Vaso para destornillador hexagonal / Inserto esagonale / Bocal hexagonal / Douille à 6 pans / Zeskant dop

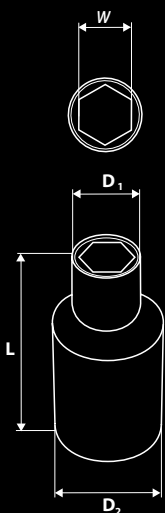

- nasadki wykonane w technologii Superlock - sockets manufactured in Superlock technology - насадки выполнены по технологии Суперлок

Ref.	w[mm]	L[mm]	D <sub>1</sub> [mm]	D <sub>2</sub> [mm]	⊖	⊕	EAN
08-220	4	25	7	12	100	500	5907558403787
08-221	4,5	25	7,5	12	100	500	5907558403794
08-222	5	25	8	12	100	500	5907558403800
08-223	5,5	25	8,5	12	100	500	5907558403817
08-224	6	25	9	12	100	500	5907558403824
08-225	7	25	10,5	12	100	500	5907558403831
08-226	8	25	12	12	100	500	5907558403848
08-227	9	25	13	13	50	500	5907558403855
08-228	10	25	14	14	50	500	5907558403862
08-229	11	25	16	16	50	500	5907558403879
08-230	12	25	17	17	50	500	5907558403886
08-231	13	25	18	18	50	500	5907558403893
08-232	14	25	20	20	50	500	5907558403909



### Nasadka sześciokątna długa

Hexagonal socket / Sechskanteinsatz / Головка сменная шестигранная / Nasadka sześciokątna / 6-ları dugökulcs-betét / Cheie tubulara hexagonală / Šestihranný nástavec / Šestihranný nástavec / Šestkotni natični nastavek / Šešakampis antgalis / Sešstūra nomaiņamā galva / Kuuskantpadrun / Шестьугольная наставка / Šesterokutna kapica / Šestougaona nasadka / Καρυδάκι εξαγώνιο / Vaso para destornillador hexagonal / Inserto esagonale / Bocal hexagonal / Douille à 6 pans / Zeskant dop

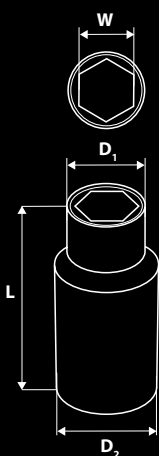

- nasadki wykonane w technologii Superlock - sockets manufactured in Superlock technology - насадки выполнены по технологии Суперлок

Ref.	w[mm]	L[mm]	D <sub>1</sub> [mm]	D <sub>2</sub> [mm]	⊖	⊕	EAN
08-235	4	50	7	12	50	500	5907558412055
08-236	4,5	50	7,5	12	50	500	5907558412062
08-237	5	50	8	12	50	500	5907558412079
08-238	5,5	50	8,5	12	50	500	5907558412086
08-239	6	50	9	12	50	500	5907558412093
08-240	7	50	10,5	12	50	500	5907558412109
08-241	8	50	12	12	50	500	5907558412116
08-242	9	50	13	13	50	500	5907558412123
08-243	10	50	14	14	50	500	5907558412130
08-244	11	50	16	16	50	300	5907558412147
08-245	12	50	17	17	50	300	5907558412154
08-246	13	50	18	18	50	300	5907558412161
08-247	14	50	20	20	50	300	5907558412178



### Klucze nasadowe

Socket wrenches / Steckschlüssel / Набор сменных головок / Ключи торцевые / Dugökulcsok / Trusa tubulară / Nástrčné kľuče / Nástrčné kľuče / Nasadni ključji / Veržlerakcio antgaliai / Nomaiņamo galvu komplekts / Padrunvõtmeš / Сменная насадка за ключом / Nasadni ključevi / Ključevi natikači / Σετ με καρυδάκια / Llaves de vaso / Chiavi a tubo / Chaves tubulares / Clefs à douilles / Dopsteutels

x14



1/4"



CrV steel

25 years guarantee



- 1 - grzechotka 72 zęby - 1 - ratchet, 72 teeth - 1 - трещотка с 72 зубьями  
 - 1 - przedłużka 75 mm - 1 - extensions 75 mm - 1 - удлинителя: 75 mm  
 - 12 - nasadek: 4, 4,5, 5, 5,5, 6, 7, 8, 9, 10, 11, 12, 13 mm - 12 sockets: 4, 4,5, 5, 5,5, 6, 7, 8, 9, 10, 11, 12, 13 mm - 12 - насадок: 4, 4,5, 5, 5,5, 6, 7, 8, 9, 10, 11, 12, 13 mm

Ref.	⊖	⊕	EAN
08-652	10	40	5907558412963

### Grzechotka

Ratchet handle / Ratsche / Трещотка / Держак з тріскотною / Racsnikulcs / Miner de hurluitoare / Řehtačka / Račňa prepínacia / Račlja / Terkšle / Reversa atslēga / Pörkratta pide / Трещотка / Račva za nasadni ključ / Racva za gedoru / Καταπά / Llave de carraca / Nottolino / Catraca de furar / Clé à cliquet / Ratel

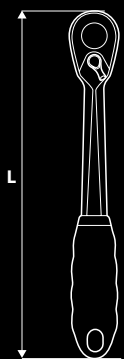

1/4"



DIN 3122

CrV steel

25 years guarantee



- korpus grzechotki wykonany ze stali CrV
- mechanizm zapadkowy 48 zębów wykonany ze stali CrMo
- ratchet body made of CrV steel
- ratchet gear 48 teeth made of CrMo steel
- корпус трещотки выполнен из стали CrV
- храповик с 48 зубьями, выполнен из стали CrMo

Ref.	L[mm]	📏	📦	EAN
08-500	135	10	60	5907558402575

### Grzechotka

Ratchet handle / Ratsche / Трещотка / Держак з тріскотною / Racsnikulcs / Miner de hurluitoare / Řehtačka / Račňa prepínacia / Račlja / Terkšle / Reversa atslēga / Pörkratta pide / Трещотка / Račva za nasadni ključ / Racva za gedoru / Καταπά / Llave de carraca / Nottolino / Catraca de furar / Clé à cliquet / Ratel

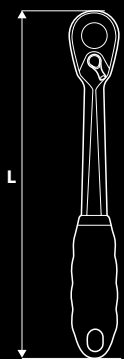

1/4"



DIN 3122

CrV steel

25 years guarantee



- korpus grzechotki wykonany ze stali CrV
- mechanizm zapadkowy 72 zęby wykonany ze stali CrMo
- ratchet body made of CrV steel
- ratchet gear 72 teeth made of CrMo steel
- корпус трещотки выполнен из стали CrV
- храповик с 72 зубьями, выполнен из стали CrMo

Ref.	L[mm]	📏	📦	EAN
08-503	145	20	100	5907558412819

### Grzechotka

Ratchet handle / Ratsche / Трещотка / Держак з тріскотною / Racsnikulcs / Miner de hurluitoare / Řehtačka / Račňa prepínacia / Račlja / Terkšle / Reversa atslēga / Pörkratta pide / Трещотка / Račva za nasadni ključ / Racva za gedoru / Καταπά / Llave de carraca / Nottolino / Catraca de furar / Clé à cliquet / Ratel



1/4"

DIN 3122



CrMo steel

PP POLYPROPYLEN

25 years guarantee



- korpus grzechotki wykonany z kompozytu o wysokiej wytrzymałości
- mechanizm zapadkowy 72 zęby wykonany ze stali CrMo
- ratchet body made of composite material of high resistance
- ratchet gear 72 teeth made of CrMo steel
- корпус трещотки выполнен из композита высокой прочности
- храповик с 72 зубьями, выполнен из стали CrMo

Ref.	L[mm]	📏	📦	EAN
08-514	150	12	72	5907558406276

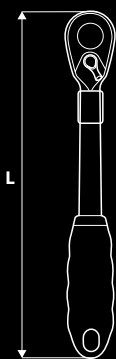

1/4"

DIN  
3122

72

CrV  
steel

25  
years  
guarantee

### Grzechotka

Ratchet handle / Ratsche / Трещотка / Держак з трісчоткою / Racsnikulcs / Miner de hurluitoare / Rehtačka / Račňa prepínacia / Raglja / Terkšle / Reversa atslēga / Pörkratta pide / Трещотка / Račva za nasadni ključ / Račva za gedoru / Κατατάκι / Llave de carraca / Nottolino / Catraca de furar / Clé à cliquet / Ratel



- korpus grzechotki ze stali CrV
- CrV steel ratchet body
- korpus из стали CrV
- mechanizm zapadkowy 72 zębów
- 72 teeth ratchet gear made of CrMo steel
- реверсивный механизм на 72 зубьев из стали CrMo

Ref.	L <sub>min</sub> [mm]	L <sub>max</sub> [mm]	⊞	⊞	EAN
08-502	150	200	25	100	5907558412802

### Uchwyt wkrętakowy

Screwdriver holder / Aufnahme für Schraubendreher / Зажим для отвёрток / Ручка викруткова / Csavarhúzó betéttartó / Mâner de șurubelnițe / Rukojeť šroubováku / Skrutkovné upínadlo / Vrečje za izvijač / Suktuvno rankena / Skrutvgriežu ietvere / Krivikeerajahoidik / Завинтен держач / Drška za izvijač / Držac za odvijač / Προσαρμογέας καταβιδιών / Sujeción de destornillador / Manico / Suporte Chave de fenda / Manche de tournevis / Houder voor schroevendraaiers



1/4"

CrV  
steel

25  
years  
guarantee



- długość 195-322mm
- length 195-322mm
- длина 195-322 мм
- z możliwością użycia grzechotki 1/4"
- allows use of 1/4" ratchet
- возможна работа с трещоткой 1/4"

Ref.	L <sub>min</sub> [mm]	L <sub>max</sub> [mm]	⊞	⊞	EAN
08-518	195	322	6	36	5907558410150

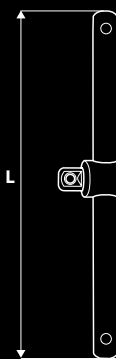

1/4"

DIN  
3122

CrV  
steel

25  
years  
guarantee

### Pokrętło

Wheel / Drehknopf / Вороток / Маховик / Hajtókár / Clupă / Otočný knoflík / Ovládacie koliesko / Raglja / Rankena / Grietzuvite / Nupp / Вертлок / K otačici / Ručica / Πόμολο / Mango / Manopola / Botão / Tourne-à-gauche / Draaiknop



Ref.	L [mm]	⊞	⊞	EAN
08-256	110	20	200	5907558403961

### Przedłużka

Extension bar / Verlängerung / Удлинитель / Подоважувач / Toldósár / Prolungtor / Prodlužovák / Predĺženie / Podaljšek / Ilgiklis / Pagarinātājs / Píkendusvarras / Удължител / Produzeta poluga / Προέκταση / Alargadera / Prolunga / Extensão / Prolongation / Verlengstuk

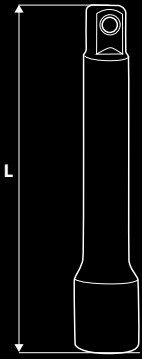

1/4" DIN 3123  
CrV steel 25 years guarantee



Ref.	L[mm]	☞	☝	EAN
08-251	50	20	200	5907558403916
08-252	75	20	200	5907558403923
08-253	100	20	200	5907558403930
08-254	150	20	200	5907558403947

### Przedłużka

Extension bar / Verlängerung / Удлинитель / Подоважувач / Toldósár / Prolungtor / Prodlužovák / Predĺženie / Podaljšek / Ilgiklis / Pagarinātājs / Píkendusvarras / Удължител / Produzeta poluga / Προέκταση / Alargadera / Prolunga / Extensão / Prolongation / Verlengstuk

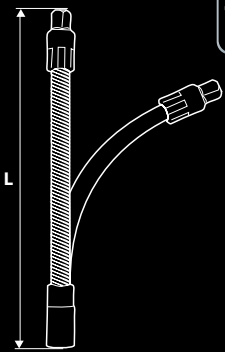

1/4" CrV steel



Ref.	L[mm]	M <sub>0</sub> max[Nm]	☞	☝	EAN
08-557	140	5	10	100	5907558402667

### Przegub

Articulated joint / Gelenk / Шарнир / Сустав / Csukló / Articulație / Kloub / Čap / Zglob / Lankstas / Šarniirs / Klamber / Шарнир / Zglob / Zglob / Μεντεσές / Articulación / Giunto / Articulação / Articulation / Spilverbinding

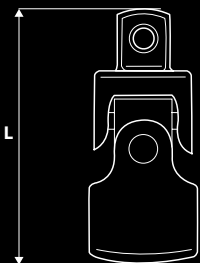

1/4" DIN 3123  
CrV steel



Ref.	L[mm]	☞	☝	EAN
08-255	35	50	400	5907558403954

### Nasadka sześciokątna

Hexagonal socket / Sechskanteinsatz / Головка сменная шестигранная / Nasadka szestiugranna / 6-lapú dugókulcs-betét / Cheie tubulara hexagonală / Šestihranný nástavec / Šesthranný nástavec / Šestkotni natični nastavek / Šešakampis antgalis / Šeštūra nomaināmā galva / Kuuskantpadrun / Шесть-зубная наставка / Šesterokutna kapica / Šestougaona nasadka / Καρυδάκι εξήγυλο / Vaso para destornillador hexagonal / Inserto esagonale / Bocal hexagonal / Douille à 6 pans / Zeskant dop

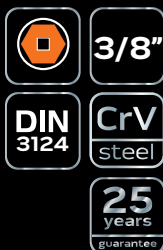
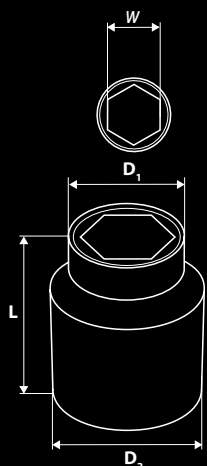

- nasadki wykonane w technologii Superlock - sockets manufactured in Superlock technology - насадки выполнены по технологии Суперлок

Ref.	W[mm]	L[mm]	D <sub>1</sub> [mm]	D <sub>2</sub> [mm]	⊕	⊞	EAN
08-106	6	28	10	17	50	400	5907558403619
08-107	7	28	11	17	50	400	5907558405989
08-108	8	28	12	17	50	400	5907558403626
08-109	9	28	14	17	50	400	5907558412390
08-110	10	28	15	17	50	400	5907558403633
08-111	11	28	16	17	50	400	5907558412406
08-112	12	28	17	16	50	400	5907558403640
08-113	13	28	18	16	50	400	5907558403657
08-114	14	28	20	17	50	400	5907558412413
08-115	15	28	22	18	50	400	5907558403664
08-116	16	28	23	19	50	300	5907558412420
08-117	17	30	24	20	50	300	5907558403671
08-118	18	30	25	22	50	300	5907558412437
08-119	19	30	26	23	50	300	5907558403688
08-120	20	32	28	24	50	300	5907558403695
08-121	21	32	28	25	50	300	5907558403701
08-122	22	32	30	26	50	200	5907558403718
08-123	23	32	31	27	50	200	5907558412444
08-124	24	32	32	28	50	200	5907558403725



### Klucze nasadowe

Socket wrenches / Steckschlüssel / Набор сменных головок / Ключи торцевой / Dugókulcsok / Trusa tubulară / Nástrčné kľuče / Nástrčné ključve / Nasadni ključji / Veržlerakció antgaliai / Nomaināmā galvu komplekts / Padrunvõtmed / Сменными наконечниками за ключовые / Nasadni ključevi / Ključevi natikači / Σετ με καρυδάκια / Llaves de vaso / Chiavi a tubo / Chaves tubulares / Clefs à douilles / Dopsleutels



- 1 - grzechotka 72 zębów
- 1 - przedłużka 150 mm
- 10 - nasadek: 6, 10, 12, 13, 14, 16, 17, 19, 21, 22 mm
- 1 - ratchet, 72 teeth
- 1 - extensions 150 mm
- 10 sockets: 6, 10, 12, 13, 14, 16, 17, 19, 21, 22 mm
- 1 трещотка с 72 зубьями
- 1 удлинителя: 150 мм
- 10 - насадок: 6, 10, 12, 13, 14, 16, 17, 19, 21, 22 мм

Ref.	⊕	⊞	EAN
08-653	6	24	5907558412970

### Grzechotka

Ratchet handle / Ratsche / Трещотка / Держак з трісчоткою / Racsnikulcs / Miner de hurluitoare / Rehačka / Račna prepínacia / Raglja / Terkšlé / Reversa atslēga / Põrkraatta pide/Tрещотка / Račva za nasadni ključ / Račva za gedoru / Καταβιά / Llave de carraca / Nottolino / Catraca de furar / Clé à cliquet / Rattel

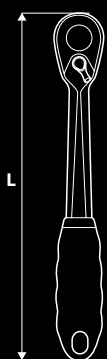

- korpus grzechotki wykonany ze stali CrV
- mechanizm zapadkowy 48 zębów wykonany ze stali CrMo
- ratchet body made of CrV steel
- ratchet gear 48 teeth made of CrMo steel
- корпус трещотки выполнен из стали CrV
- храповик с 48 зубьями, выполнен из стали CrMo

Ref.	L[mm]	⊕	⊞	EAN
08-505	195	5	60	5907558402582

### Grzechotka

Ratchet handle / Ratsche / Трещотка / Держак з трісчаткою / Racsnikulcs / Míner de hurluitoare / Rehtačka / Račňa prepínacia / Raglja / Terkšlë / Reversa atslëga / Pörkratta pide/Трещотка / Račva za nasadni ključ / Racva za gedoru / Καστανιά / Llave de carraca / Nottolino / Catraca de furar / Clé à cliquet / Ratel



3/8"



DIN 3122

CrV steel

25 years guarantee



- korpus grzechotki wykonany ze stali CrV
- mechanizm zapadkowy 72 zęby wykonane ze stali CrMo
- ratchet body made of CrV steel
- ratchet gear 72 teeth made of CrMo steel
- корпус трещотки выполнен из стали CrV
- храповик с 72 зубьями, выполнен из стали CrMo

Ref.	L[mm]	📦	📦	EAN
08-507	195	5	60	5907558412833

### Grzechotka

Ratchet handle / Ratsche / Трещотка / Держак з трісчаткою / Racsnikulcs / Míner de hurluitoare / Rehtačka / Račňa prepínacia / Raglja / Terkšlë / Reversa atslëga / Pörkratta pide/Трещотка / Račva za nasadni ključ / Racva za gedoru / Καστανιά / Llave de carraca / Nottolino / Catraca de furar / Clé à cliquet / Ratel



3/8"



DIN 3122

CrMo steel

PP POLYPROPYLEN

25 years guarantee



- korpus grzechotki wykonany z kompozytu o wysokiej wytrzymałości
- mechanizm zapadkowy 72 zęby wykonane ze stali CrMo
- ratchet body made of composite material of high resistance
- ratchet gear 72 teeth made of CrMo steel
- корпус трещотки выполнен из композита высокой прочности
- храповик с 72 зубьями, выполнен из стали CrMo

Ref.	L[mm]	📦	📦	EAN
08-513	200	12	48	5907558406269

### Grzechotka

Ratchet handle / Ratsche / Трещотка / Держак з трісчаткою / Racsnikulcs / Míner de hurluitoare / Rehtačka / Račňa prepínacia / Raglja / Terkšlë / Reversa atslëga / Pörkratta pide/Трещотка / Račva za nasadni ključ / Racva za gedoru / Καστανιά / Llave de carraca / Nottolino / Catraca de furar / Clé à cliquet / Ratel

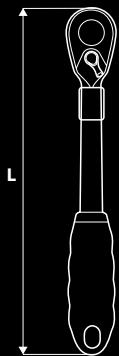

3/8"



DIN 3122



CrV steel

25 years guarantee



- korpus grzechotki wykonany z kompozytu o wysokiej wytrzymałości
- mechanizm zapadkowy 72 zęby wykonane ze stali CrMo
- ratchet body made of composite material of high resistance
- ratchet gear 72 teeth made of CrMo steel
- корпус трещотки выполнен из композита высокой прочности
- храповик с 72 зубьями, выполнен из стали CrMo

Ref.	L <sub>min</sub> [mm]	L <sub>max</sub> [mm]	📦	📦	EAN
08-506	215	315	12	48	5907558412826



### Pokrętło

Wheel / Drehknopf / Вороток / Маховик / Hajtókar / Clupă / Otočný knoflík / Ovládacie koliesko / Raglja / Rankena / Grietuvīte / Nupp / Върток / Kотаці / Ručica / Покол / Mango / Manopola / Bořá / Tourne-à-gauche / Драаќнокр



Ref.	L[mm]	⌀	⊠	EAN
08-155	165	20	100	5907558403770



### Przedłużka

Extension bar / Verlängerung / Удлинитель / Подовзжувач / Toldószár / Prolungator / Prodlužovák / Predĺženie / Podaljšek / Ilgiklis / Pagarinātājs / Piekendusvarras / Удължител / Produzerna poluga / Προέκταση / Alargadera / Prolunga / Extensão / Prolongation / Verlengstuk



Ref.	L[mm]	⌀	⊠	EAN
08-151	75	20	200	5907558403732
08-152	125	20	200	5907558403749
08-153	150	20	100	5907558403756



### Przegub

Przegub / Articulated joint / Gelenk / Шарнир / Сустав / Csukló / Articulație / Kloub / Čap / Zglob / Lankstas / Šarnīrs / Klamber / Шарнир / Zglob / Zglob / Μεγθεός / Articulación / Giunto / Articulação / Articulation / Spilverbinding



Ref.	L[mm]	⌀	⊠	EAN
08-154	50	50	400	5907558403763

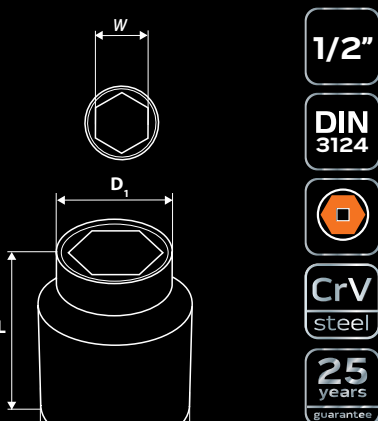

### Nasadka sześciokątna

Hexagonal socket / Sechskanteinsatz / Головка сменная шестигранная / Nasadka szesciokątna / 6-lapú dugókulcs-betét / Cheje tubulara hexagonală / Šestihranný nástavec / Šestihranný nástavec / Šestkotni ptični nastavek / Šešakampis antgalis / Sešstūra no maināmā galva / Kluskantpadrun / Шесточълна наставка / Šesterokutna kapica / Šestougaona nasadka / Καρδάνι εξαγωνο / Vaso para destornillador hexagonal / Inserto esagonale / Bocal hexagonal / Douille à 6 pans / Zeskant dop



- \* nasadki wykonane w technologii Superlock - \* sockets manufactured in Superlock technology - \* насадки выполнены по технологии Суперлок

Ref.	W[mm]	L[mm]	D <sub>1</sub> [mm]	D <sub>2</sub> [mm]	⌀	⊠	EAN
08-008*	8	38	13	22	10	100	5907558403503
08-009*	9	38	15	22	10	100	5907558403510
08-010*	10	38	15	22	10	100	5907558402353
08-011*	11	38	17	22	10	100	5907558403527
08-012*	12	38	18	22	10	100	5907558402360
08-013*	13	38	19	22	10	100	5907558402377
08-014*	14	38	20	22	10	100	5907558408232
08-015*	15	38	21	22	10	100	5907558402384
08-016*	16	38	21	22	10	100	5907558403534
08-017*	17	38	22	24	10	100	5907558402391
08-018*	18	38	26	24	10	100	5907558403541
08-019*	19	38	26	24	10	100	5907558402407
08-020*	20	38	28	26	10	100	5907558412451
08-021*	21	38	28	26	10	100	5907558403558
08-022*	22	38	30	26	10	100	5907558402414
08-023*	23	38	32	28	10	100	5907558412468
08-024*	24	38	32	28	10	100	5907558402421
08-025*	25	38	32	28	10	100	5907558412475
08-026*	26	42	36	31	10	100	5907558403565
08-027*	27	42	36	31	10	100	5907558402438
08-028*	28	42	38	33	10	100	5907558403572
08-029*	29	44	38	34	10	100	5907558403589
08-030*	30	44	40	34	10	100	5907558402445
08-031*	31	44	42	36	10	100	5907558403596
08-032*	32	44	42	36	10	100	5907558402452
08-036	36	44	47	48	10	60	5907558403602







### Nasadka sześciokątna długa

Hexagonal socket / Sechskanteinsatz / Головка сменная шестигранная / Nasadka szestiogranna / 6-lapú dugókulcs-betét / Cheie tubulara hexagonală / Šestihranný nástavec / Šesthranný nástavec / Šestkotni natični nastavek / Šešjakampis antgalis / Seššūra nomaiņāmā galva / Kuuskantpadrun / Шестоугълна наставка / Šesterokutna kapica / Šestougaona nasadka / Καρυδάκι εξαγώνιο / Vaso para destornillador hexagonal / Inserto esagonal / Bocal hexagonal / Douille à 6 pans / Zeskant dop

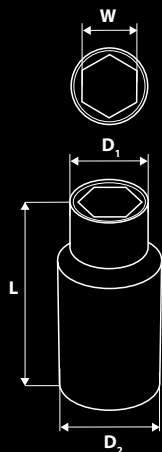

1/2" DIN 3124  
CrV steel  
25 years guarantee



- nasadki wykonane w technologii Superlock - sockets manufactured in Superlock technology - nasadki wykonane w technologii Superlock



Ref.	W[mm]	L[mm]	D <sub>1</sub> [mm]	D <sub>2</sub> [mm]	⊖	⊞	EAN
08-039	8	77	13,2	22	10	50	5907558410501
08-040	9	77	14	22	12	144	5907558410518
08-041	10	77	15	22	12	144	5907558402469
08-052	11	77	17	22	12	144	5907558410525
08-042	12	77	18	22	12	144	5907558402476
08-043	13	77	19	21	12	144	5907558402483
08-053	14	77	21	22	12	144	5907558410532
08-044	15	77	22	21	12	144	5907558402490
08-054	16	77	22	22	12	144	5907558410549
08-045	17	77	22	24	12	144	5907558402506
08-055	18	77	23	25	6	96	5907558410556
08-046	19	77	24	26	6	96	5907558402513
08-057	20	77	25	27	6	96	5907558412482
08-056	21	77	26	28	6	96	5907558410563
08-047	22	77	26	30	6	96	5907558402520
08-058	23	77	27	31	6	72	5907558412499
08-048	24	77	28	32	6	72	5907558402537
08-049	27	77	31	36	6	72	5907558402544
08-050	30	77	33	39	6	48	5907558402551
08-051	32	77	36	42	6	48	5907558402568

### Nasadka dwunastokątna

Bi-hexagonal socket / Zwölfkanteinsatz / Головка сменная двенадцатигранная / Nasadka dwanaściamiogranna / 12-lapú dugókulcs-betét / Cheie tubulara, priza in 12 pute / Dvanáctihranný nástavec / Dvanáštihranný nástavec / Dvanajstkotni nasadni ključ / Dvylikakampis antgalis / Divpadsmitšūra nomaiņāmā galva / Kaksteistkantpadrun / Дванадесетоугълна наставка / Dvanaesterokutna kapica / Dvanaestuugaona nasadka / Καρυδάκι δωδεκάγωνα / Vaso destornillador de encaje dodecagonal / Inserto poligonal / Bocal de doze ângulos / Douille à 12 pans / Twaalfkant dop

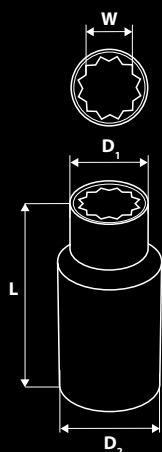

1/2" DIN 3124  
CrV steel  
25 years guarantee

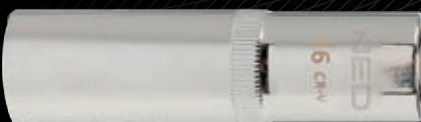

- nasadki wykonane w technologii Superlock - sockets manufactured in Superlock technology - nasadki wykonane w technologii Superlock



Ref.	W[mm]	L[mm]	D <sub>1</sub> [mm]	D <sub>2</sub> [mm]	⊖	⊞	EAN
08-070	10	77	15,4	22	12	144	5907558405613
08-086	11	77	16,5	21,9	12	144	5907558410594
08-071	12	77	18	22	12	144	5907558405620
08-072	13	77	19	21,8	12	144	5907558405637
08-073	14	77	27	21,9	12	144	5907558408249
08-074	15	77	22	21	12	144	5907558405644
08-075	16	77	21,9	20	12	144	5907558406078
08-076	17	77	23,7	21,8	12	144	5907558405651
08-077	18	77	25,7	23,9	6	96	5907558406085
08-078	19	77	25,7	23,7	6	96	5907558405668
08-080	21	77	27,6	25,7	6	96	5907558408256
08-081	22	77	29,7	25,7	6	96	5907558405675
08-082	24	45	47,7	39,9	6	72	5907558405682
08-083	27	77	35,6	30,7	6	72	5907558405699
08-084	30	77	39,8	33,6	6	48	5907558405705
08-085	32	77	42	35,7	6	48	5907558405712

### Grzechotka

Ratchet handle / Ratsche / Трещотка / Держак з трісноткою / Racsnikulcs / Míner de hurluitoare / Řehtačka / Račňa prepinacia / Račlja / Terkšle / Reversa atslēga / Pörkratta pide/Трещотка / Račva za nasadni ključ / Račva za gedoru / Καρσάκι / Llave de carraca / Nottolino / Catraca de furar / Clé à cliquet / Ratel

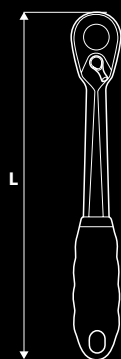

1/2" 48  
DIN 3122  
CrV steel  
25 years guarantee



- korpus grzechotki wykonany ze stali CrV - ratchet body made of CrV steel - корпус трещотки выполнен из стали CrV  
- mechanizm zapadkowy 48 zębów - ratchet gear 48 teeth made of CrMo steel - храповик с 48 зубьями, выполнен из стали CrMo

Ref.	L[mm]	⊖	⊞	EAN
08-510	245	5	40	5907558402599

### Nasadka dwunastokątna

Bi-hexagonal socket / Zwölfkanteinsatz / Головка сменная двенадцатигранная / Насадка двенадцатигранная / 12-lapú dugókulcs-betét / Cheie tubulara, priză în 12 pute / Dvanáctihřanný nástavec / Dvanásthřanný nástavec / Dvanajstkotni nasadni ključ / Dvyilkakampis antgalis / Divpadsmitstūra nomaināmā galva / Kaksteistkantpadrun / Дванадцетогольмна наставка / Dvanaesterokutna kapica / Dvanaestougona nasadka / Карубакі двібежыма / Vaso destornillador de encaje dodecagonal / Inserto poligonal / Bocal de doze ângulos / Douille à 12 pans / Twaalfkant dop

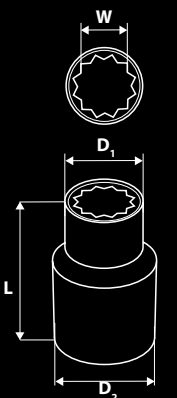

1/2"

DIN 3124



25 years guarantee

CrV steel



- sferyczny, 12-kątny kształt pasujący do śrub TORX, SPLINE, 12-kątnych, metrycznych, stalowych i kwadratowych

- spherical, 12 points shape for TORX, SPLINE, 12-points metric, unified and square screws

- сферическая, 12-гранная форма, подходящая к винтам Torx, Spline, 12-гранных метрическим, дюймовым и квадратным

Ref.	W[mm]	L[mm]	D <sub>1</sub> [mm]	D <sub>2</sub> [mm]	☞	☝	EAN
08-580	8	38	13,1	21,7	10	100	5907558408263
08-581	9	38	14,3	21,7	10	100	5907558408270
08-582	10	38	15,2	21,8	10	100	5907558408287
08-583	11	38	16,4	21,7	10	100	5907558408294
08-584	12	38	18	21,7	10	100	5907558408300
08-585	13	38	19	21,7	10	100	5907558408317
08-586	14	38	20	21,7	10	100	5907558408324
08-587	15	38	21,7	20,1	10	100	5907558408331
08-588	16	38	23	20,9	10	100	5907558408348
08-589	17	38	23,8	21,9	10	100	5907558408355
08-590	18	38	25,7	23,4	10	100	5907558408362
08-591	19	38	25,8	23,8	10	100	5907558408379
08-592	20	38	27,7	25,9	10	100	5907558408386
08-593	21	38	28,8	25,9	10	100	5907558408393
08-594	22	38	30	25,9	10	100	5907558408409
08-595	23	38	31	27,1	10	100	5907558412505
08-596	24	38	31,7	27,8	10	100	5907558408416
08-597	27	42	35,8	30,9	10	100	5907558408423
08-598	30	44	39,8	33,8	10	100	5907558408430
08-599	32	44	42	36	10	100	5907558408447



### Klucze nasadowe

Socket wrenches / Steckschlüssel / Набор сменных головок / Ключи торцевые / Dugókulcsok / Trusa tubulară / Nástrčné kľuče / Nástrčné kľuče / Nasadni ključ / Veržlerakčio antgaliai / Nomaināmo galvu komplekts / Padruniņtmed / Сменными наконечники за ключевое / Nasadni ključevi / Ključevi patikači / Set ue карубакіа / Llaves de vaso / Chiavi a tubo / Chaves tubulares / Cléfs à douilles / Dapsleutels

1/2"



x12



25 years guarantee

CrV steel



- 1 - grzechotka 72 zęby  
- 1 - przedłużka 125 mm  
- 10 - nasadek: 6, 10, 12, 13, 14, 16, 17, 19, 21, 22 mm

- 1 - ratchet, 72 teeth  
- 1 - extensions 125 mm  
- 10 sockets: 6, 10, 12, 13, 14, 16, 17, 19, 21, 22 mm

- 1 трещотка с 72 зубьями  
- 1 удлинителя: 125 мм  
- 10 - насадок: 6, 10, 12, 13, 14, 16, 17, 19, 21, 22 мм

Ref.	☞	☝	EAN
08-654	6	12	5907558412987



### Nasadki

Socket set / Aufsätze / Головки торцевые / Набор насадок торцевых / Dugókulcs készlet / Set duze / Nástavce / Súprava nástavcov / Nasadni ključ / Antgaliiu komplektas / Muciņas / Padruniņkomplekt / Set gedora / Συλλογή καρубακιών / Vasos destornilladores / Boccole / Bocais / Douilles / Dappen

1/2"

x8



CrV steel

25 years guarantee



MM	10	12	13	15	17	19	22	24
INCH	3/8	15/32	1/2	19/32		3/4	7/8	15/16
STAR	E12	E16				E24		

- sferyczny, 12-kątny kształt pasujący do śrub TORX, SPLINE, 12-kątnych, metrycznych, stalowych i kwadratowych

- spherical, 12 points shape for TORX, SPLINE, 12-points metric, unified and square screws

- сферическая, 12-гранная форма, подходящая к винтам Torx, Spline, 12-гранных метрическим, дюймовым и квадратным

Ref.	W[mm]	m[kg]	☞	☝	EAN
08-650	10,12,13,15,17,19,22,24	1,1	0	20	5907558406283



### Nasadki

Socket set / Aufsätze / Головки торцевые / Набор насадок торцевых / Dugókulcs készlet / Set duze / Nástavce / Súprava nástavcov / Nasadni ključ / Antgalių komplektas / Mucijās / Padrunikomplekti / Set gedora / Συλλογή καρδαικών / Vasos destornilladores / Boccole / Bocais / Douilles / Doppen

1/2"

x8

CrV steel

25 years guarantee



MM	10	12	13	15	17	19	22	24
INCH	3/8	15/32	1/2	19/32	3/4	7/8	15/16	
STAR	E12	E16				E24		

- sferyczny, 12-kątny kształt pasujący do śrub TORX, SPLINE, 12-kątnych, metrycznych, calowych i kwadratowych

- spherical, 12 points shape for TORX, SPLINE, 12-points metric, unified and square screws

- сферическая, 12-гранная форма, подходящая к винтам Torx, Spline, 12-гранных метрическим, дюймовым и квадратным

Ref.	W[mm]	☞	☝	EAN
08-651	10,12,13,15,17,19,22,24	0	30	5907558406290



### Grzechotka

Ratchet handle / Ratsche / Трещотка / Держак з трісноткою / Racsnikulcs / Míner de hurliwtoare / Řehtačka / Račňa prepinacia / Raglja / Terkšle / Reversa atslēga / Pörkratta pide/Трещотка / Račva za nasadni ključ / Racva za gedoru / Καστανιά / Llave de carraca / Nottolino / Catraca de furar / Clé à cliquet / Ratel

1/2"

DIN 3122

CrV steel

25 years guarantee



- korpus grzechotki wykonany ze stali CrV  
- mechanizm zapadkowy 72 zęby wykonany ze stali CrMo

- ratchet body made of CrV steel  
- ratchet gear 72 teeth made of CrMo steel

- корпус трещотки выполнен из стали CrV  
- храповик с 72 зубьями, выполнен из стали CrMo

Ref.	L[mm]	☞	☝	EAN
08-520	195	5	30	5907558412840



### Grzechotka

Ratchet handle / Ratsche / Трещотка / Держак з трісноткою / Racsnikulcs / Míner de hurliwtoare / Řehtačka / Račňa prepinacia / Raglja / Terkšle / Reversa atslēga / Pörkratta pide/Трещотка / Račva za nasadni ključ / Racva za gedoru / Καστανιά / Llave de carraca / Nottolino / Catraca de furar / Clé à cliquet / Ratel

1/2"

DIN 3122

CrMo steel

PP POLYPROPYLEN

25 years guarantee



- korpus grzechotki wykonany z kompozytu o wysokiej wytrzymałości  
- mechanizm zapadkowy 72 zęby wykonany ze stali CrMo

- ratchet body made of composite material of high resistance  
- ratchet gear 72 teeth made of CrMo steel

- корпус трещотки выполнен из композита высокой прочности  
- храповик с 72 зубьями, выполнен из стали CrMo

Ref.	L[mm]	☞	☝	EAN
08-511	250	5	40	5907558402605



### Grzechotka

Ratchet handle / Ratsche / Трещотка / Держак з трісноткою / Racsnikulcs / Míner de hurliwtoare / Řehtačka / Račňa prepinacia / Raglja / Terkšle / Reversa atslēga / Pörkratta pide/Трещотка / Račva za nasadni ključ / Racva za gedoru / Καστανιά / Llave de carraca / Nottolino / Catraca de furar / Clé à cliquet / Ratel

1/2"

CrV steel

25 years guarantee

DIN 3122



- korpus grzechotki wykonany ze stali CrV  
- mechanizm zapadkowy 72 zęby wykonany ze stali CrMo

- ratchet body made of CrV steel  
- ratchet gear 72 teeth made of CrMo steel

- корпус трещотки выполнен из стали CrV  
- храповик с 72 зубьями, выполнен из стали CrMo

Ref.	L <sub>min</sub> [mm]	L <sub>max</sub> [mm]	☞	☝	EAN
08-515	305	445	0	20	5907558408546



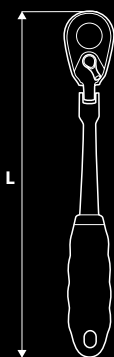

### Grzechotka

Ratchet handle / Ratsche / Трещотка / Держак з трісцючкою / Racsnikulcs / Miner de hurluitoare / Řehotačka / Račna prepinacia / Raglja / Terkšlè / Reversa atslēga / Põrkraatta pide/Трещотка / Račva za nasadni ključ / Račva za gedoru / Καστανιά / Llave de carraca / Nottolino / Catraca de furar / Clé à cliquet / Ratel



- korpus grzechotki ze stali CrV
- mechanizm zapadkowy 72 zęby
- wykonany ze stali CrMo
- zakres ruchu głowicy 180 stopni

- CrV steel ratchet body
- 72 teeth ratchet gear made of CrMo steel
- head range 180 degrees

- корпус из стали CrV
- реверсивный механизм на 72 зубьев из стали CrMo
- угол вращения головки 180 градусов

Ref.	L[mm]	⊖	⊞	EAN
08-519	285	0	24	5907558410167



### Grzechotka

Ratchet handle / Ratsche / Трещотка / Держак з трісцючкою / Racsnikulcs / Miner de hurluitoare / Řehotačka / Račna prepinacia / Raglja / Terkšlè / Reversa atslēga / Põrkraatta pide/Трещотка / Račva za nasadni ključ / Račva za gedoru / Καστανιά / Llave de carraca / Nottolino / Catraca de furar / Clé à cliquet / Ratel



- korpus grzechotki wykonany ze stali CrV
- mechanizm zapadkowy 48 zębów wykonany ze stali CrMo

- ratchet body made of CrV steel
- ratchet gear 48 teeth made of CrMo steel

- корпус трещотки выполнен из композита высокой прочности
- храповик с 48 зубьями, выполнен из стали CrMo

Ref.	L[mm]	⊖	⊞	EAN
08-516	255	6	24	5907558409291



### Řękojeść z przegubem

Flex handle / Handgriff mit Gelenk / Вороток / Рукія з шарніром / Flexibilis hajtókar / Maner cu articulație / Kloubové vratídlo / Klobová rukovät' / Račaj z zglobom / Rankena su lankstu / Pagarinātājs mucipnatslēga / Liidendīga kāerīde / Ръкохватка с шарнир / Drška sa zglobom / Drška sa zglobom / Μανέλα ολιθαίνουσα / Mango con articulación / Manico con giunta / Cabo com Articulação / Poignée articulée / Handvat met spilverbinding



Ref.	L <sub>min</sub> [mm]	L <sub>max</sub> [mm]	⊖	⊞	EAN
08-553	470	620	5	10	5907558409598



### Rękojeść z przegubem

Flex handle / Handgriff mit Gelenk / Воротнок / Руквиѣ з шарниром / Flexibilis hajtókar / Maner cu articulație / Kloubové vratídlo / Кĺbová rukoväť / Ročaj z zglobom / Rankena su lankstu / Pagarinātājs tuciņpatslēgai / Līgendīga kāerīde / Ръкохватка с шарнир / Drška sa zglobom / Drška sa zglobom / Μανέλα ολιθαίνουσα / Mango con articulación / Manico con giunta / Cabo com Articulação / Poignée articulée / Handvat met spilverbinding

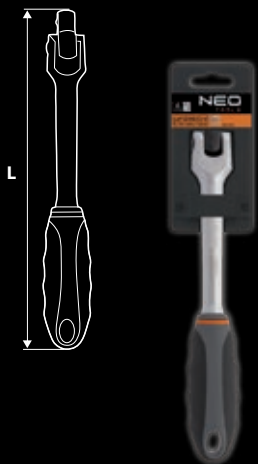

1/2"  
CrV  
steel  
25  
years  
guarantee



Ref.	L[mm]			EAN
08-559	250	10	40	5907558403367
08-560	450	10	20	5907558403374

### Pokrętko

Wheel / Drehknopf / Воротнок / Маховик / Hajtókar / Clupă / Otočný knoflík / Ovládacie koliesko / Raglja / Rankena / Grieztuvīte / Nurr / Върток / Kотаџици / Ručica / Πόμολο / Mango / Manopola / Botão / Tourne-à-gauche / Draaiknop

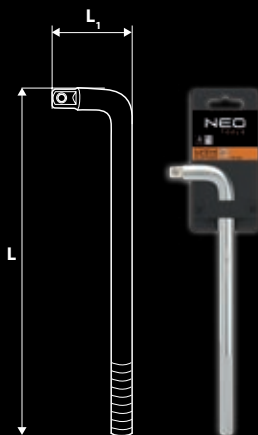

1/2"  
CrV  
steel  
25  
years  
guarantee

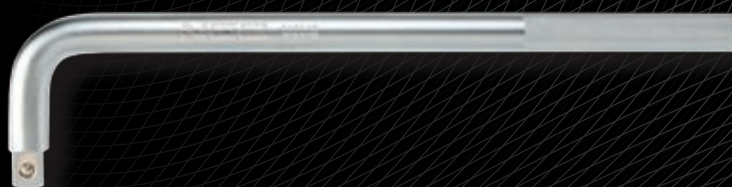

Ref.	L[mm]	L <sub>1</sub> [mm]			EAN
08-556	250	75	0	40	5907558408607

### Pokrętko

Wheel / Drehknopf / Воротнок / Маховик / Hajtókar / Clupă / Otočný knoflík / Ovládacie koliesko / Raglja / Rankena / Grieztuvīte / Nurr / Върток / Kотаџици / Ručica / Πόμολο / Mango / Manopola / Botão / Tourne-à-gauche / Draaiknop

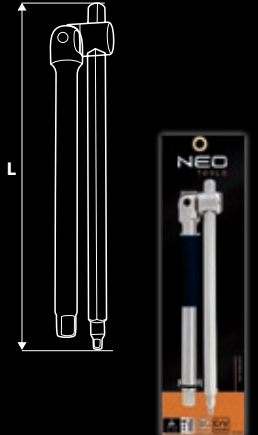

1/2"  
3/8"  
1/4"  
CrV  
steel  
25  
years  
guarantee



Ref.	L[mm]			EAN
08-566	250	6	36	5907558403381

### Pokrętko

Wheel / Drehknopf / Воротнок / Маховик / Hajtókar / Clupă / Otočný knoflík / Ovládacie koliesko / Raglja / Rankena / Grieztuvīte / Nurr / Върток / Kотаџици / Ručica / Πόμολο / Mango / Manopola / Botão / Tourne-à-gauche / Draaiknop

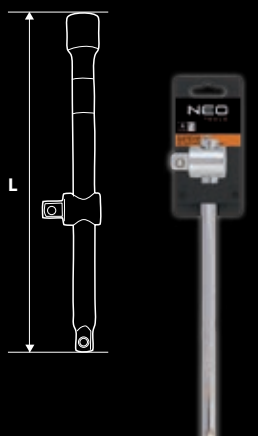

1/2"  
DIN  
3122  
CrV  
steel  
25  
years  
guarantee



Ref.	L[mm]			EAN
08-555	250	5	50	5907558402650



1/2"  
DIN 3123  
CrV steel  
25 years guarantee

### Przedłużka

Extension bar / Verlängerung / Удлинитель / Подовзжувач / Toldószár / Prolungitor / Prodlužovák / Predĺženie / Podaljšek / Ilgiklis / Pagarinātājs / Píkendusvarras / Удължител / Produzена ролуга / Προέκταση / Alargadera / Prolunga / Extensão / Prolongation / Verlengstuk

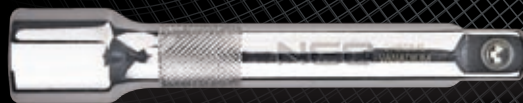

Ref.	L[mm]	☞	☞	EAN
08-552	125	10	50	5907558402636
08-554	250	10	50	5907558402643

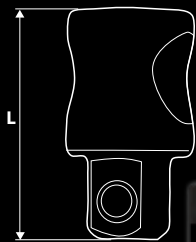

1/2"  
DIN 3123  
CrV steel

### Redukcja

Adapter / Reduzierstück / Переходник / Перехідник / Adapter / Adaptor / Redukce / Redukcia / Adapter / Adapteris / Päreja / Адаптор / Adapter / Προσαρμογέας / Adaptador / Riduzione / Redução / Réduction / Reductiestuk



Ref.	L[mm]	Ra[mm]	☞	☞	EAN
08-562	26	3/8"М x 1/4"F	10	100	5907558403329
08-563	37	3/8"М x 1/2"F	10	100	5907558403336
08-550	27	1/2"М x 3/8"F	10	100	5907558402612
08-565	50	1/2"М x 3/4"F	10	100	5907558403350
08-564	46	3/4"М x 1/2"F	10	100	5907558403343

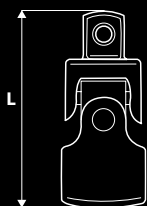

1/2"  
DIN 3123  
CrV steel

### Przegub

Przegub / Articulated joint / Gelenk / Шарнир / Сустав / Csukló / Articulație / Kloub / Џар / Zglob / Lankstas / šarniřs / Klamber / Шарнир / Zglob / Zglob / Μεντεσές / Articulación / Giunto / Articulação / Articulation / Spilverbinding



Ref.	L[mm]	☞	☞	EAN
08-551	65	10	100	5907558402629



1/2"  
CrV steel

### Przedłużka

Extension bar / Verlängerung / Удлинитель / Подовзжувач / Toldószár / Prolungitor / Prodlužovák / Predĺženie / Podaljšek / Ilgiklis / Pagarinātājs / Píkendusvarras / Удължител / Produzена ролуга / Προέκταση / Alargadera / Prolunga / Extensão / Prolongation / Verlengstuk



Przedłużka elastyczna      Flexible extension      Удлинитель гибкий

Ref.	L[mm]	M <sub>0</sub> max[Nm]	☞	☞	EAN
08-558	190	40	10	40	5907558402674



### Nasadki

Socket set / Aufsätze / Головки торцевые / Набор насадок торцевых / Dugókulcs készlet / Set duze / Nástavce / Súprava nádstavcov / Nasadni ključ / Antgalių komplektas / Mucijas / Padrunikomplekti / Set gedora / Συλλογή καρδιακών / Vasos destornilladores / Boccole / Bocais / Douilles / Dorpen

3/8"

x7

CrV  
steel

25  
years  
guarantee



- 4 nasadki 3/8": 14, 16, 18, 21 mm
- przegub uniwersalny
- pokreślto z zabierakiem - 150 mm
- 4 sockets 3/8": 14, 16, 18, 21 mm
- universal joint
- sliding T bar - 150 mm
- 4 головки 3/8": 14, 16, 18, 21 мм
- универсальный шарнир
- вороток 150 мм

Ref.	W[mm]	m[kg]	☞	☝	EAN
09-610	14, 16, 18, 21	1,0	1	12	5907558410358

### Nasadka do świec

Spark plug socket / Aufsatz für Zündkerzen / Головка сменная свечная / Ключ свичный / Gyertyakulcs-betét / Cheie tubulara pentru bujii / Nástavec na svičky / Nástavec na svečky / Nasadni ključ za svečke / Galvutė žvakėms / Sveču atslēga / Kūūnlarpadrun / Наставка за свещи / Kapica za svijeće / Nasadka za svećice / Καρδιακή για μπουζί / Vaso para bujía / Inserto per candele / Boccal p. velas / Douille à bougie / Kaarsendop

1/2"



CrV  
steel

25  
years  
guarantee

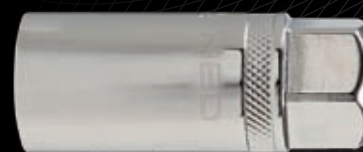
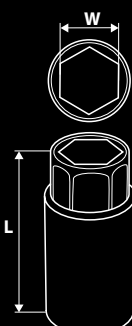

Ref.	W[mm]	L[mm]	☞	☝	EAN
08-090	16	65	24	144	5907558406092
08-091	21	68	24	96	5907558406252

### Nasadka sześciokątna

Hexagonal socket / Sechskanteinsatz / Головка сменная шестиугольная / Насадка шестиугольная / 6-ları dugókulcs-betét / Cheie tubulara hexagonală / Šestihranný nástavec / Šestihranný nástavec / Šestkotni natični nastavek / Šešjakampis antgališ / Šešstūra natamainā galva / Kuuskantpadrun / Шестыугольная наставка / Šesterokutna kapica / Šestougaona nasadka / Καρδιακή εξαγωνία / Vaso para destornillador hexagonal / Inserto esagonale / Boccal hexagonal / Douille à 6 pans / Zeskant dop

3/4"

DIN  
3124



CrV  
steel

25  
years  
guarantee

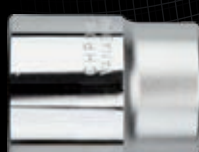
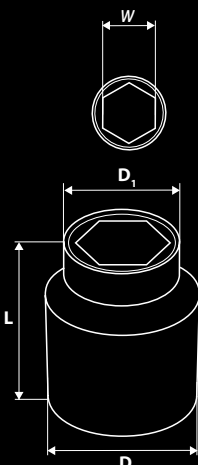

Ref.	W[mm]	L[mm]	D <sub>1</sub> [mm]	D <sub>2</sub> [mm]	☞	☝	EAN
08-300	19	51	29	33	10	80	5907558404180
08-301	21	51	31	33	10	80	5907558410600
08-302	22	51	32	36	10	80	5907558404197
08-303	23	51	33	36	10	80	5907558412512
08-304	24	51	34	36	10	80	5907558404203
08-305	25	51	36	36	10	80	5907558412529
08-317	26	52	37	36	10	80	5907558412536
08-306	27	52	38	36	10	80	5907558404210
08-307	28	52	39	36	10	60	5907558412543
08-318	29	53	40	38	10	60	5907558412550
08-308	30	54	42	38	10	60	5907558404227
08-309	32	56	44	38	10	60	5907558404234
08-310	33	56	46	38	10	60	5907558410617
08-316	34	56	46	38	10	60	5907558410624
08-319	35	57	48	40	10	60	5907558412567
08-311	36	59	50	42	10	40	5907558404241
08-312	38	60	52	45	10	40	5907558404258
08-313	41	64	56	45	10	40	5907558404265
08-314	46	68	62	47	10	20	5907558404272
08-315	50	72	68	48	10	20	5907558404289
08-340	55	76	71	48	10	20	5907558412574
08-341	60	78	80	50	10	20	5907558412581

### Nasadka dwunastokątna

Bi-hexagonal socket / Zwölfkanteinsatz / Головка сменная двенадцатигранная / Nasadka dwanaścianowa / 12-ları dugökulcs-betét / Cheie tubulara , priza in 10 pute / Dvanáctihřanný nástavec / Dvanásthřanný nástavec / Dvanajstkotni nasadni ključ / Dvylíkakampis antgalis / Divpadsmitstūra nomaiņāmā galva / Kaksteistkantpadrun / Дванадцетостънна наставка / Dvanaesterokutna kapica / Dvanaestougona nasadka / Καρυδάκι δωδεκάγωνο / Vaso destornillador de encaje dodecagonal / Inserto poligonal / Bocal de doze ângulos / Douille à 12 pans / Twaalfkant dop

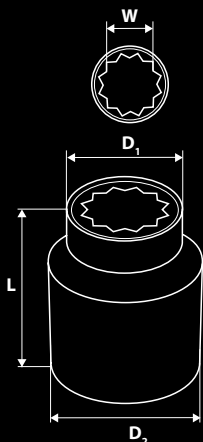

3/4"

DIN  
3124



CrV  
steel

25  
years  
guarantee

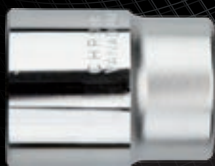

Ref.	W[mm]	L[mm]	D <sub>1</sub> [mm]	D <sub>2</sub> [mm]	☞	☞	EAN
08-320	19	50	29	32	10	80	5907558406108
08-321	22	50	32	36	10	80	5907558406115
08-322	24	51	34	36	10	80	5907558406122
08-323	27	52	38	36	10	80	5907558406139
08-324	30	54	42	38	10	60	5907558406146
08-325	32	56	44	38	10	60	5907558406153
08-326	36	58	50	42	10	40	5907558406160
08-327	38	60	52	45	10	40	5907558406177
08-328	41	64	56	45	10	40	5907558406184
08-329	46	68	62	47	10	20	5907558406191
08-330	50	72	68	48	10	20	5907558406207
08-331	55	76	74	48	10	20	5907558406214
08-332	60	79	80	48	10	20	5907558406221
08-333	21	52	38	36	10	80	5907558410631
08-334	33	56	44	38	10	60	5907558410648
08-335	34	56	46	38	10	60	5907558410655



### Grzechotka

Ratchet handle / Ratsche / Трещотка / Держак з трісчаткою / Racsnikulcs / Miner de hurluitoare / Řehtačka / Račňa prepínacia / Raglja / Terkšle / Reversa atslēga / Pörkratta pide / Трещотка / Račva za nasadni ključ / Račva za gedoru / Καταπίλι / Llave de carraca / Nottolino / Catraca de furar / Clé à cliquet / Ratel

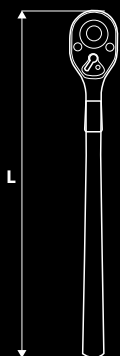

3/4"



CrV  
steel

25  
years  
guarantee



- mechanizm zapadkowy 24 zęby
- ratchet gear 24 teeth
- реверсивный механизм на 24 зуба
- ze stali stopowej CrV
- made of alloy CrV steel
- из легированной стали CrV

Ref.	L[mm]	☞	☞	EAN
08-355	500	0	10	5907558404449



### Rękojeść z przegubem

Flex handle / Handgriff mit Gelenk / Вороток / Руківця з шарніром / Flexibilis hajtókár / Maner cu articulație / Kloubové vratidlo / Kĺbová rukoväť / Ročaj z zgłobom / Rankena su lankstu / Pagarinātājs mucīnatslēgai / Liigendiga käepide / Ръчохотка с шарнир / Drška sa zgłobom / Drška sa zgłobom / Μανέλα ολοβαίνουσα / Mango con articulación / Manico con giunta / Cabo com Articulação / Poignée articulée / Handvat met spilverbinding



3/4"

CrV  
steel



Ref.	L[mm]	☞	☞	EAN
08-356	510	0	10	5907558404456





### Pokrętko

Wheel / Drehknopf / Вороток / Маховик / Hajtókar / Clupă / Otočný knoflík / Ovládacie koliesko / Raglja / Rankena / Grietzuvite / Nurr / Върток / Kотаџиџи / Ručica / Póмоло / Mango / Manopala / Botão / Tourne-à-gauche / Draaiknop



3/4"

CrV  
steel

25  
years  
guarantee

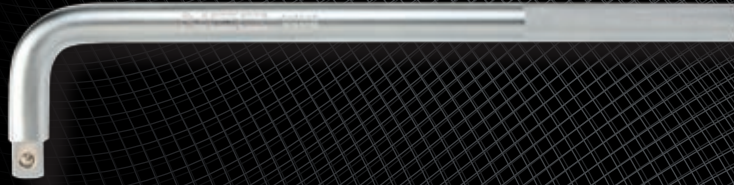

Ref.	L[mm]	L <sub>1</sub> [mm]	☞	☝	EAN
08-357	450	110	0	10	5907558405873

### Pokrętko

Wheel / Drehknopf / Вороток / Маховик / Hajtókar / Clupă / Otočný knoflík / Ovládacie koliesko / Raglja / Rankena / Grietzuvite / Nurr / Върток / Kотаџиџи / Ručica / Póмоло / Mango / Manopala / Botão / Tourne-à-gauche / Draaiknop

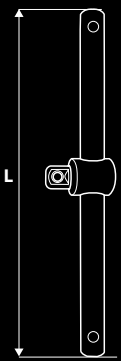

3/4"

DIN  
3122

CrV  
steel

25  
years  
guarantee



Ref.	L[mm]	☞	☝	EAN
08-353	460	10	20	5907558404425

### Przedłużka

Extension bar / Verlängerung / Удлинитель / Подовезжувач / Toldószár / Prolungitor / Prodlužovák / Predĺženie / Podaljšek / Ilgiklis / Pagarinātājs / Píkendusvarras / Удължител / Produzена ролуга / Προέκταση / Alargadera / Prolunga / Extensão / Prolongation / Vertengstuk



3/4"

DIN  
3123

CrV  
steel

25  
years  
guarantee



Ref.	L[mm]	☞	☝	EAN
08-350	100	10	40	5907558404296
08-351	200	10	20	5907558404302
08-352	400	0	10	5907558404418

### Przegub

Przegub / Articulated joint / Gelenk / Шарнир / Сустав / Csukló / Articulație / Kloub / Čap / Zglob / Lankstas / Šarnirs / Klamber / Шарнир / Zglob / Zglob / Μεντεός / Articulación / Giunto / Articulação / Articulation / Spilverbinding

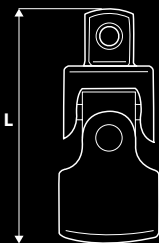

3/4"

DIN  
3123

CrV  
steel



Ref.	L[mm]	☞	☝	EAN
08-354	100	0	40	5907558404432

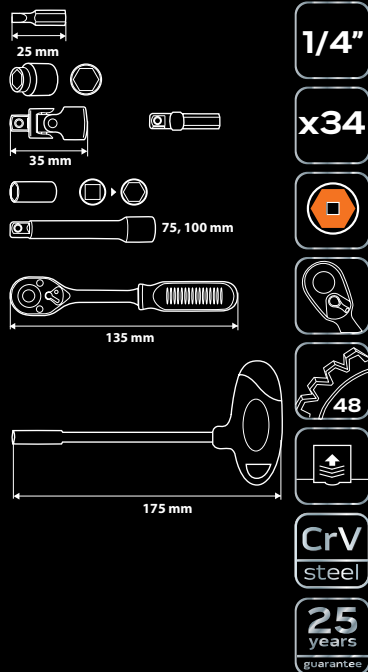

### Klucze nasadowe

Socket wrenches / Steckschlüssel / Набор сменных головок / Ключи торцевой / Dugókulcsok / Trusa tubulare / Nástrčné klíče / Nástrčné klíče / Nasadni ključji / Veržlerakčio antgaliai / Nomaināmo galvu komplekts / Padrūnīvotmed / Сменяеми накрайници за ключове / Nasadni ključevji / Ključevji natikači / Σετ με καριδάκια / Llaves de vaso / Chiavi inglesi / Chaves tubulares / Clefs à douilles / Dopsleutels



- 1 - grzechotka 48 zębów - 135 mm
- 1 - uchwyt wkrętakowy „T”
- 1 - przegub uniwersalny - 35 mm
- 2 - przedłużki 75 mm, 150 mm
- 1 - adapter do nasadek
- 1 - adapter do końcówek
- 11 - nasadek/sockets/насадок: 5, 5.5, 6, 7, 8, 9, 10, 11, 12, 13, 14 mm
- 16 - końcówek wkrętakowych 25 mm
- płaskie: 4.5, 6.5, 8 mm
- krzyżowe: PH1, PH2, PH3
- sześciokątne: H3, H4, H5, H6
- Torx z otworem: TT10, TT15, TT20, TT25, TT30, TT40

- 1 - ratchet, 48 teeth - 135mm
- 1 - T-handle bit holder
- 1 - universal joint - 35mm
- 2 - extensions 75 mm, 150mm
- 1 - socket adapter
- 1 - bit adapter
- 11 - sockets: 5, 5.5, 6, 7, 8, 9, 10, 11, 12, 13, 14mm
- 16 - screwdriver bits 25mm
- flat: 4.5, 6.5, 8 mm
- cross: PH1, PH2, PH3
- hexagonal: H3, H4, H5, H6
- Torx tamperproof: TT10, TT15, TT20, TT25, TT30, TT40

- 1 трещотка с 48 зубьями
- 1 ручка „Т”-образная
- 1 шарнир универсальный
- 2 удлинителя: 75 мм, 150 мм
- 1 держатель насадки
- 1 держатель наконечника
- 11 - насадок: 5, 5.5, 6, 7, 8, 9, 10, 11, 12, 13, 14 мм
- 16 - наконечников 25 мм
- плоские: 4.5, 6.5, 8 мм
- крестовые: PH1, PH2, PH3
- шестиугольные: H3, H4, H5, H6
- Torx с отверстием: TT10, TT15, TT20, TT25, TT30, TT40

Ref.	m[kg]	☞	☞	EAN
08-601	1,0	0	8	5907558402681

### Klucze nasadowe

Socket wrenches / Steckschlüssel / Набор сменных головок / Ключи торцевой / Dugókulcsok / Trusa tubulare / Nástrčné klíče / Nástrčné klíče / Nasadni ključji / Veržlerakčio antgaliai / Nomaināmo galvu komplekts / Padrūnīvotmed / Сменяеми накрайници за ключове / Nasadni ključevji / Ključevji natikači / Σετ με καριδάκια / Llaves de vaso / Chiavi inglesi / Chaves tubulares / Clefs à douilles / Dopsleutels

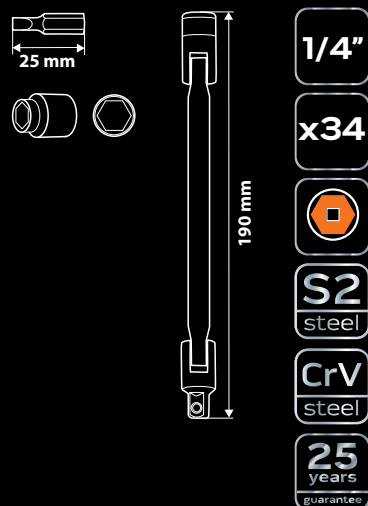

- 1 uchwyt przegubowy do nasadek i końcówek wkrętakowych 1/4"
- 11 nasadek: 5, 5.5, 6, 7, 8, 9, 10, 11, 12, 13, 14 mm
- 29 końcówek wkrętakowych - 25 mm
- płaskie: 4, 5, 6, 7, 8 mm
- krzyżowe: PH1, PH2, PH3, PZ1, PZ3, PZ2x2
- Torx z otworem: TT8, TT9, TT10, TT15, TT20, TT25, TT27, TT30, TT40
- sześciokątne: H2, H2.5, H3, H4, H5, H6, H7, H8

- 1 flexible holder for sockets and driver bits 1/4"
- 11 sockets: 5, 5.5, 6, 7, 8, 9, 10, 11, 12, 13, 14mm
- 29 driver bits - 25mm
- slotted: 4, 5, 6, 7, 8mm
- cross slotted: PH1, PH2, PH3, PZ1, PZ3, PZ2x2
- Torx tamperproof: TT8, TT9, TT10, TT15, TT20, TT25, TT27, TT30, TT40
- hexagonal: H2, H2.5, H3, H4, H5, H6, H7, H8

- 1 шарнирный держатель торцевых головок и насадок 1/4"
- 11 торцевых головок: 5, 5.5, 6, 7, 8, 9, 10, 11, 12, 13, 14mm
- 29 насадок - 25mm
- шлицевые: 4, 5, 6, 7, 8mm
- Phillips: PH1, PH2, PH3, PZ1, PZ3, PZ2x2
- Torx с отверстием: TT8, TT9, TT10, TT15, TT20, T25, TT27, TT30, TT40
- шестигранные: H2, H2.5, H3, H4, H5, H6, H7, H8

Ref.	m[kg]	☞	☞	EAN
08-603	1,0	0	20	5907558409307

## Zestaw narzędzi

Tool and socket set / Werkzeugsatz / Набор инструментов / Инструмент з насадками, набір / Dugókulcs és szerszám / Set scule de grădini / Sada náradí / Súpřava náradia kombi/Garnitura orodij / Įrankių komplektas / Instrumentu komplekts / Tööriistade ja padrunite komplekt / Теодор компл. / Gedora set / Συλλογή εργαλείων / Juego de herramientas / Set di attrezzi / Kit de ferramentas / Jeu d'outils / Gereedschapsset



25 mm

35 mm

150 mm

135 mm

6,5 x 100 mm  
PH 2 x 100 mm

160 mm

160 mm

1/4"

x33

48

S2 steel

CrV steel

25 years guarantee

- 1 – szczypce uniwersalne - 160 mm
- 1 – szczypce wydłużone - 160 mm
- 1 – wkrętak płaski - 6.5x100 mm
- 1 – wkrętak krzyżowy - PH2x100 mm
- 1 – grzechotka - 1/4" - 135 mm
- 11 – nasadek: 5, 5.5, 6, 7, 8, 9, 10, 11, 12, 13, 14 mm
- 1 – przedłużka: 1/4", 150 mm
- 1 – adapter do końcówek
- 1 – przegub uniwersalny
- 13 – końcówki wkrętakowych
- krzyżowe: PH1, PH2, PH3
- sześciokątne: H3, H4, H5, H6
- Torx z otworem: TT10, TT15, TT20, TT25, TT30, TT40
- 1 – combination pliers - 160 mm
- 1 – long nose pliers - 160 mm
- 1 – slotted screwdriver - 6.5x100 mm
- 1 – cross slotted screwdriver - PH2x100 mm
- 1 – ratchet - 1/4" - 135 mm
- 11 – sockets: 5, 5.5, 6, 7, 8, 9, 10, 11, 12, 13, 14 mm
- 1 – extension/удлинитель: 1/4", 150 mm
- 1 – socket adapter
- 1 – universal joint
- 13 – screwdriver bits
- cross: PH1, PH2, PH3
- hexagonal/шестиугольные: H3, H4, H5, H6
- Torx tamperproof: TT10, TT15, TT20, TT25, TT30, TT40
- 1 – плоскогубцы комбинированные - 160 мм
- 1 – плоскогубцы удлиненные - 160 мм
- 1 – отвертка плоская - 6.5x100 мм
- 1 – отвертка крестовая - PH2x100 мм
- 1 – трещотка - 1/4" - 135 мм
- 11 – насадок: 5, 5.5, 6, 7, 8, 9, 10, 11, 12, 13, 14 мм
- 1 – удлинитель: 1/4", 150 мм
- 1 – держатель наконечника
- 1 – шарнир универсальный
- 13 наконечников отвертки
- крестовые: PH1, PH2, PH3
- шестиугольные: H3, H4, H5, H6
- Torx с отверстием: TT10, TT15, TT20, TT25, TT30, TT40

Ref.	m[kg]	📦	📦	EAN
08-631	1,9	1	8	5907558403398

## Końcówki wkrętakowe

Driver bits / Einsätze für Schraubendreher / Насадки / Наконечники викрѳткои / Csavarhúzó betétek / Set biti / Šroubovákové nástavce / Skrutkovacie nástavce / Nastavki za izvijače / Atsuktuvo antgaliai / Skrūvgręža uzgali / Krivikeeraajatsakud / Накрайници за отѳертка / Nastavci za odvijač / Nastavci za odvijač / Καταβιδόμυες / Puntas destornilladoras / Punte per cacciaviti / Ponteiros Chave de fenda / Embouts de tournevis / Schroevendraaierendstukken



25 mm

1/4"

x42

x42

S2 steel

CrV steel

25 years guarantee

- uchwyt wkrętakowy „T” z grzechotką
- teleskopowa przedłużka do końcówek
- teleskopowa przedłużka do nasadek
- 30 końcówek wkrętakowych 1/4", 25 mm
- końcówki płaskie: 3, 4, 5, 6, 7 mm
- końcówki krzyżowe: 2x PH1, 2x PH2, 2x PH3, 2x PZ1, 2x PZ2, 2x PZ3
- Torx: T10, T15, T20, T25, T27, T30, T40
- końcówki sześciokątne: H2, H2.5, H3, H4, H5, H6
- 9 nasadek 1/4" wykonanych w technologii Superlock
- nasadki: 5, 6, 7, 8, 9, 10, 11, 12, 13 mm
- T bit holder with ratchet
- telescopic extension for bits
- telescopic extension for sockets
- 30 driver bits 1/4", length 25 mm
- slotted bits: 3, 4, 5, 6, 7 mm
- cross slotted bits: 2x PH1, 2x PH2, 2x PH3, 2x PZ1, 2x PZ2, 2x PZ3
- Torx: T10, T15, T20, T25, T27, T30, T40
- hexagonal bits: H2, H2.5, H3, H4, H5, H6
- 9 Superlock sockets 1/4"
- sockets: 5, 6, 7, 8, 9, 10, 11, 12, 13 mm
- ключ трещоточный „Т”-образный
- телескопический удлинитель для насадок
- телескопический удлинитель для торцевых головок
- 30 насадок 1/4", длина 25 мм
- шлицевые: 3, 4, 5, 6, 7 мм
- Phillips: 2x PH1, 2x PH2, 2x PH3, 2x PZ1, 2x PZ2, 2x PZ3
- Torx: T10, T15, T20, T25, T27, T30, T40
- шестигранные: H2, H2.5, H3, H4, H5, H6
- 9 торцевых головок 1/4" - технология Superlock
- насадки: 5, 6, 7, 8, 9, 10, 11, 12, 13 мм

Ref.	📦	📦	EAN
08-709	12	12	5907558410174

### Klucze nasadowe

Socket wrenches / Steckschlüssel / Набор сменных головок / Ключи торцевые / Dugókulcsok / Trusa tubulare / Nástrčné kľúče / Nástrčné kľúče / Nasadni ključji / Veržlerakčio antgalioi / Nomaiñāto galvu komplekts / Padrunvõtmed / Сменяемые наконечники за ключовые / Nasadni ključevni / Ključevni natičasti / Σετ με καριδάκια / Llaves de vaso / Chiavi inglesi / Chaves tubulares / Clefs à douilles / Dopsleutels

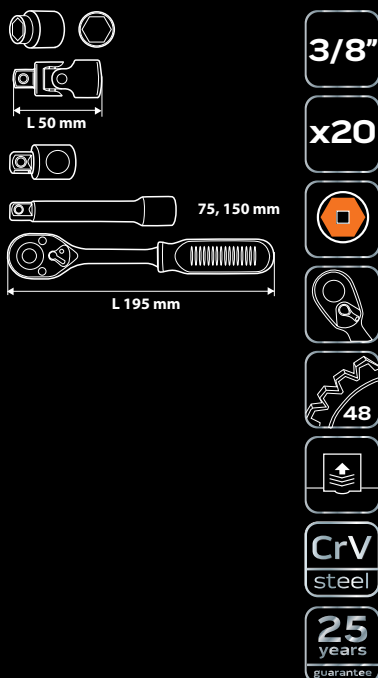

- 1 - grzechotka 48 zębów - 195 mm
- 1 - ratchet, 48 teeth - 195 mm
- 1 - трещотка с 48 зубьями - 195 мм
- 1 - przegub uniwersalny - 50 mm
- 1 - universal joint - 50 mm
- 1 - шарнир универсальный - 50 мм
- 2 - przedłużki 75 mm, 150 mm
- 2 - extensions 75 mm, 150 mm
- 2 - удлинителя: 75 мм, 150 мм
- 1 - redukcja 3/8" M x 1/2" F
- 1 - reduction 3/8" M x 1/2" F
- 1 - присоединительный квадрат 3/8" M x 1/2" F
- 15 - nasadek: 6, 7, 8, 9, 10, 11, 12, 13, 14, 15, 16, 17, 19, 22, 24 mm
- 15 sockets: 6, 7, 8, 9, 10, 11, 12, 13, 14, 15, 16, 17, 19, 22, 24 mm
- 15 - насадок: 6, 7, 8, 9, 10, 11, 12, 13, 14, 15, 16, 17, 19, 22, 24 мм

Ref.	m[kg]	☞	☝	EAN
08-610	1,6	0	8	5907558402698

### Klucze nasadowe

Socket wrenches / Steckschlüssel / Набор сменных головок / Ключи торцевые / Dugókulcsok / Trusa tubulare / Nástrčné kľúče / Nástrčné kľúče / Nasadni ključji / Veržlerakčio antgalioi / Nomaiñāto galvu komplekts / Padrunvõtmed / Сменяемые наконечники за ключовые / Nasadni ključevni / Ključevni natičasti / Σετ με καριδάκια / Llaves de vaso / Chiavi inglesi / Chaves tubulares / Clefs à douilles / Dopsleutels

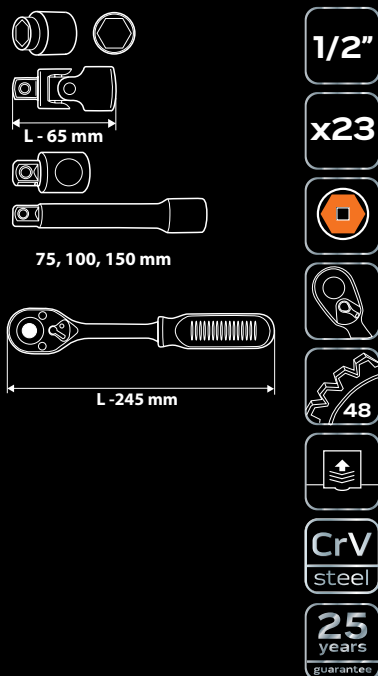

- 1 - grzechotka 48 zębów - 245 mm
- 1 - ratchet, 48 teeth - 245 mm
- 1 - трещотка с 48 зубьями - 245 мм
- 1 - przegub uniwersalny - 65 mm
- 1 - universal joint - 65 mm
- 1 - шарнир универсальный - 65 мм
- 3 - przedłużki 75 mm, 100 mm, 150 mm
- 3 - extensions 75 mm, 100 mm, 150 mm
- 3 - удлинителя: 75 мм, 100 мм, 150 мм
- 1 - redukcja 1/2" M x 3/8" F
- 1 - reduction 1/2" M x 3/8" F
- 1 - присоединительный квадрат 1/2" M x 3/8" F
- 17 - nasadek: 8, 10, 11, 12, 13, 14, 15, 16, 17, 18, 19, 21, 22, 24, 27, 30, 32 mm
- 17 - sockets: 8, 10, 11, 12, 13, 14, 15, 16, 17, 18, 19, 21, 22, 24, 27, 30, 32 mm
- 17 - насадок: 8, 10, 11, 12, 13, 14, 15, 16, 17, 18, 19, 21, 22, 24, 27, 30, 32 мм

Ref.	m[kg]	☞	☝	EAN
08-616	3,5	0	6	5907558402704

### Klucze nasadowe

Socket wrenches / Steckschlüssel / Набор сменных головок / Ключи торцевые / Dugókulcsok / Trusa tubulare / Nástrčné kľuče / Nástrčné klúče / Nasadni ključji / Veržlerakció antgalliai / Nomaināmo galvu komplekts / Padrunvõtmed / Сменными наконечники за ключовые / Nasadni ključevni / Ključevni patikači / Σετ με καρδιάκια / Llaves de vaso / Chiavi inglesi / Chaves tubulares / Clefs à douilles / Dopsleutels

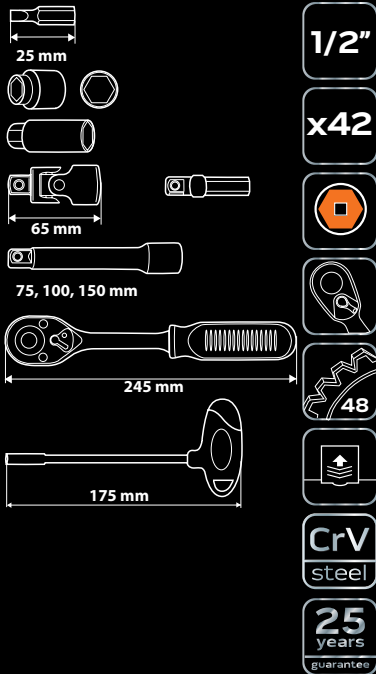

- 1 - grzechotka 48 zębów - 245 mm
- 1 - uchwyt wkrętakowy „T” - 175 mm
- 1 - przegub uniwersalny - 65 mm
- 2 - przedłużki 125 mm, 250 mm
- 2 - nasadki do świec 16 mm, 21 mm
- 18 - nasadek: 8, 9, 10, 11, 12, 13, 14, 15, 16, 17, 18, 19, 21, 22, 24, 27, 30, 32 mm
- 17 - końcówek wkrętakowych 25 mm
- płaskie: 4,5, 6,5, 8 mm
- krzyżowe: PH1, PH2, PH3
- sześciokątne: H3, H4, H5, H6
- Torx z otworem: TT10, TT15, TT20, TT25, TT27, TT30, TT40

- 1 - ratchet, 48 teeth - 245 mm
- 1 - T-handle bit holder - 175 mm
- 1 - universal joint - 65 mm
- 2 - extensions 125 mm, 250 mm
- 2 - spark plug sockets 16 mm, 21 mm
- 18 - sockets: 8, 9, 10, 11, 12, 13, 14, 15, 16, 17, 18, 19, 21, 22, 24, 27, 30, 32 mm
- 17 - screwdriver bits 25 mm
- flat: 4,5, 6,5, 8 mm
- cross: PH1, PH2, PH3
- hexagonal: H3, H4, H5, H6
- Torx tamperproof: TT10, TT15, TT20, TT25, TT27, TT30, TT40

- 1 трещотка с 48 зубьями - 245 мм
- 1 отвертка T для наконечников и насадок 175 мм
- 1 шарнир универсальный - 65 мм
- 2 удлинителя: 125 мм, 250 мм
- 2 насадки для свечей: 16 мм, 21 мм
- 18 - насадок: 8, 9, 10, 11, 12, 13, 14, 15, 16, 17, 18, 19, 21, 22, 24, 27, 30, 32 мм
- 17 - наконечников 25 мм
- плоские: 4,5, 6,5, 8 мм
- крестовые: PH1, PH2, PH3
- шестиугольные: H3, H4, H5, H6
- Torx с отверстием: TT10, TT15, TT20, TT25, TT27, TT30, TT40

Ref.	m[kg]	☞	☝	EAN
08-621	4,5	0	4	5907558402711

### Klucze nasadowe

Socket wrenches / Steckschlüssel / Набор сменных головок / Ключи торцевые / Dugókulcsok / Trusa tubulare / Nástrčné kľuče / Nástrčné klúče / Nasadni ključji / Veržlerakció antgalliai / Nomaināmo galvu komplekts / Padrunvõtmed / Сменными наконечники за ключовые / Nasadni ključevni / Ključevni patikači / Σετ με καρδιάκια / Llaves de vaso / Chiavi inglesi / Chaves tubulares / Clefs à douilles / Dopsleutels

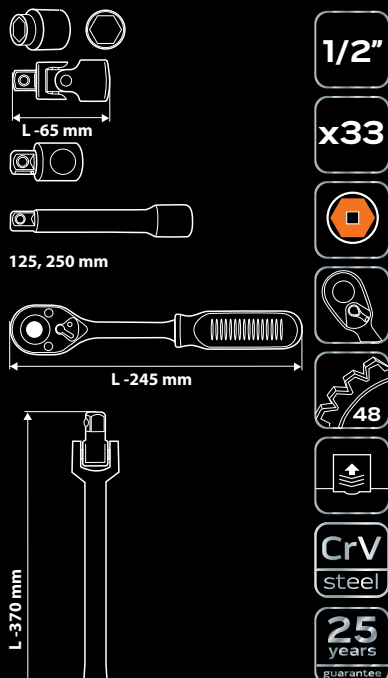

- 1 - grzechotka 48 zębów - 245 mm
- 1 - przegub uniwersalny - 65 mm
- 2 - przedłużki 125 mm, 250 mm
- 1 - rekojęść z przegubem - 370 mm
- 1 - redukcja 1/2" M x 3/8" F
- 27 - nasadek: 8, 9, 10, 11, 12, 13, 14, 15, 16, 17, 18, 19, 20, 21, 22, 23, 24, 25, 26, 27, 28, 29, 30, 32, 34, 35, 36 mm

- 1 - ratchet, 48 teeth - 245 mm
- 1 - universal joint - 65 mm
- 2 - extensions 125 mm, 250 mm
- 1 - flex handle - 370 mm
- 1 - reduction 1/2" M x 3/8" F
- sockets: 8, 9, 10, 11, 12, 13, 14, 15, 16, 17, 18, 19, 20, 21, 22, 23, 24, 25, 26, 27, 28, 29, 30, 32, 34, 35, 36 mm

- 1 трещотка с 48 зубьями - 245 мм
- 1 шарнир универсальный - 65 мм
- 2 удлинителя: 125 мм, 250 мм
- 1 рукоятка с шарниром - 370 мм
- 1 присоединительный квадрат 1/2" M x 3/8" F
- 27 - насадок: 8, 9, 10, 11, 12, 13, 14, 15, 16, 17, 18, 19, 20, 21, 22, 23, 24, 25, 26, 27, 28, 29, 30, 32, 34, 35, 36 мм

Ref.	m[kg]	☞	☝	EAN
08-618	4,6	0	4	5907558402728

### Klucze nasadowe

Socket wrenches / Steckschlüssel / Набор сменных головок / Ключи торцевые / Dugokulcsok / Trusa tubulare / Nástrčné kľúče / Nástrčné kľúče / Nasadni ključevi / Veržlerakčio antgaliai / Nomaināmo galvu komplekts / Padrunvõlmed / Сменные наконечники за ключовые / Nasadni ključevi / Ključevi natikači / Σετ με καριδάκια / Llaves de vaso / Chiavi inglesi / Chaves tubulares / Clefs à douilles / Dopseutels



25 mm

1/4"

1/2"

x71

1/4" 35 mm, 1/2" 65 mm

1/4" - 50 mm, 1/2" - 125, 250 mm

1/2" - 250 mm

1/4" - 110 mm

1/4", 1/2"

48

8, 10, 12, 13, 14, 17 mm

CrV  
steel

25  
years  
guarantee



MM	4	4.5	5.5	6	8	10	11	12	13	14	15	16	18	19	21	22	24	27	30	32	
INCH	5/32		7/32		5/16	3/8	7/16	15/32	1/2		19/32	5/8		3/4	13/16	7/8	15/16	1.1/16	1.1/8	1.1/4	
STAR	E5	E6			E10	E12	E14	E16		E18		E20	E22	E24							

#### 1/4"

- 1 - grzechotka 48 zębów - 135 mm
- 1 - przegub uniwersalny - 35 mm
- 1 - przedłużka - 50 mm
- 1 - adapter do końcówek wkrętakowych
- 1 - pokrętło z zabierakiem - 110 mm
- 1 - uchwyt wkrętakowy do końcówek - 150 mm
- 22 - końcówki wkrętakowe
- krzyżowe: PH1, PH2, PH3, PZ1, PZ2, PZ3
- płaskie: 4.5, 6.5, 8 mm
- Torx z otworem: TT10, TT15, TT20, TT25, TT27, TT30, TT40
- sześciokątne: H3, H4, H5, H6, H7, H8
- 12 - nasadek dwunastokątnych Spline: 4, 4.5, 5, 5.5, 6, 7, 8, 9, 10, 11, 12, 13 mm
- 6 - kluczy płasko oczkowych: 8, 10, 12, 13, 14, 17 mm

#### 1/2"

- 1 - grzechotka 48 zębów - 245 mm
- 1 - przegub uniwersalny - 65 mm
- 2 - przedłużki 125 mm, 250 mm
- 1 - redukcja 1/2" M x 3/8" F
- 1 - pokrętło z zabierakiem 250 mm
- 2 - nasadki do świec zapłonowych 16 i 21 mm
- 18 - nasadek sferycznych: 10, 11, 12, 13, 14, 15, 16, 17, 18, 19, 20, 21, 22, 23, 24, 27, 30, 32 mm

#### 1/4"

- ratchet 48 teeth - 135 mm
- universal joint - 35 mm
- extensions - 50 mm
- adapter for screwdriver bits
- spinner handle - 110 mm
- screwdriver bit holder - 150 mm
- 22 screwdriver bits
- cross: PH1, PH2, PH3, PZ1, 2, 3
- flat: 4.5, 6.5, 8 mm
- Torx tamperproof: TT10, TT15, TT20, TT25, TT27, TT30, TT40
- hexagonal: H3, H4, H5, H6, H7, H8
- spherical sockets: 4, 4.5, 5, 5.5, 6, 7, 8, 9, 10, 11, 12, 13 mm
- combination spanners : 8, 10, 12, 13, 14, 17 mm

#### 1/2"

- ratchet 48 teeth - 245 mm
- universal joint - 65 mm
- 2 - extensions 125 mm, 250 mm
- reduction 1/2" M x 3/8" F
- spinner handle 250 mm
- spark plug sockets 16 i 21 mm
- spherical spline socket 12 points: 10, 11, 12, 13, 14, 15, 16, 17, 18, 19, 20, 21, 22, 23, 24, 27, 30, 32 mm

#### 1/4"

- трещотка 48 зубьев - 135 мм
- шарнир карданный - 35 мм
- удлинитель - 50 мм
- адаптер для наконечников
- вороток - 110 мм
- держатель наконечников - 150 мм
- 22 отверточных наконечника
- крестовые: PH1, PH2, PH3, PZ1, 2, 3
- шлицевые: 4.5, 6.5, 8 мм
- Торх с отверстием: TT10, TT15, TT20, TT25, TT27, TT30, TT40
- шестигранные: H3, H4, H5, H6, H7, H8
- 12 - головки сменные 12-гранные: 4, 4.5, 5, 5.5, 6, 7, 8, 9, 10, 11, 12, 13 мм
- ключей комбинированных : 8, 10, 12, 13, 14, 17 мм

#### 1/2"

- трещотка 48 зубьев - 245 мм
- шарнир карданный - 65 мм
- 2 - удлинителя 125 мм, 250 мм
- 1 - переходник 1/2" M x 3/8" F
- 1 - вороток 250 мм
- 2 - головки торцевые свечные 16, 21 мм
- 18 - сферических торцевых головок: 10, 11, 12, 13, 14, 15, 16, 17, 18, 19, 20, 21, 22, 23, 24, 27, 30, 32 мм

Ref.	m[kg]	📦	📦	EAN
08-635	5,7	0	4	5907558406306

### Klucze nasadowe

Socket wrenches / Steckschlüssel / Набор сменных головок / Ключи торцевые / Dugókulcsok / Trusa tubulare / Nástrčné klúče / Nástrčné klúče / Nasadni ključiči / Veržlerakčio antgaliai / Normaināmo galvu komplekts / Padrunvõtmed / Сменяемые наконечники за ключом / Nasadni ključeviči / Ključeviči patikači / Σετ με καρδιάκια / Llaves de vaso / Chiavi inglesi / Chaves tubulares / Clefs à douilles / Dopsleutels

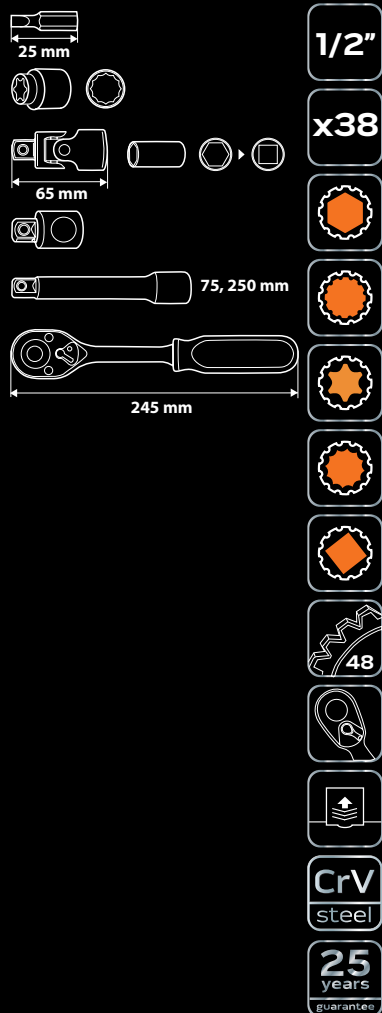

MM	10	11	12	13	14	15	16	18	19	21	22	24	27	30	32
INCH	3/8	7/16	15/32	1/2		19/32	5/8		3/4	13/16	7/8	15/16	1.1/16	1.1/8	1.1/4
STAR	E12	E14	E16		E18		E20	E22	E24						

- 1 - grzechotka 48 zębów - 245 mm
- 1 - przegub uniwersalny - 65 mm
- 2 - przedłużki 75 mm, 250 mm
- 1 - redukcja 1/2" M x 3/8" F
- 1 - adapter do końcówek
- 16 - nasadek dwunastokątnych Spline  
10, 11, 12, 13, 14, 15, 16, 17, 18, 19, 21, 22, 24, 27, 30, 32 mm
- 16 - końcówek wkrętakowych
- sześciokątne: H4, H5, H6, H7, H8, H10, H12
- Torx z otworem: TT20, TT25, TT27, TT30, TT40, TT45, TT50, TT55, TT60

- 1 - ratchet 48 teeth - 245 mm
- 1 - universal joint - 65 mm
- 2 - extensions 75 mm, 250 mm
- 1 - reduction 1/2" M x 3/8" F
- 1 - bit adapter
- 16 - spherical spline socket 12 points:  
10, 11, 12, 13, 14, 15, 16, 17, 18, 19, 21, 22, 24, 27, 30, 32 mm
- 16 - screwdriver bits
- hexagonal: H4, H5, H6, H7, H8, H10, H12
- Torx tamperproof: TT20, TT25, TT27, TT30, TT40, TT45, TT50, TT55, TT60

- 1 трещотка с 48 зубьями - 245 мм
- 1 шарнир универсальный - 65 мм
- 2 удлинителя: 75 мм, 250 мм
- 1 присоединительный квадрат 1/2" M x 3/8" F
- 1 держатель наконечника
- 16 - головки сменные 12-гранные:  
10, 11, 12, 13, 14, 15, 16, 17, 18, 19, 21, 22, 24, 27, 30, 32 мм
- 16 - наконечников
- шестиугольные: H4, H5, H6, H7, H8, H10, H12
- Torx с отверстием: TT20, TT25, TT27, TT30, TT40, TT45, TT50, TT55, TT60

Ref.	m[kg]	☞	☞	EAN
08-630	3,7	0	6	5907558402735



100, 200, 400 mm

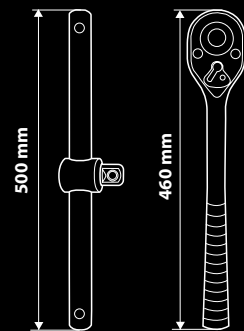

3/4"

x21



CrV  
steel

25  
years  
guarantee

### Klucze nasadowe

Socket wrenches / Steckschlüssel / Набор сменных головок / Ключи торцевые / Dugókulcsok / Trusa tubulare / Nástrčné kľúče / Nástrčné kľúče / Nasadni ključji / Veržlerakcio antgaliak / Nomaināmo galvu komplekts / Padrunvõlmed / Сменная насадка за ключом / Nasadni ključev / Ključevni patikači / Σετ με καριδάκια / Llaves de vaso / Chiavi inglesi / Chaves tubulares / Clefs à douilles / Dopsleutels



- 16 – nasadek: 19, 21, 22, 23, 24, 26, 27, 29, 30, 32, 35, 36, 38, 41, 46, 50 mm
- 1 – pokrętko z zabierakiem - 460 mm
- 1 – grzechotka 24 zęby 500 mm
- 3 – przedłużki 100 mm, 200 mm, 400 mm
- 16 – sockets: 19, 21, 22, 23, 24, 26, 27, 29, 30, 32, 35, 36, 38, 41, 46, 50 mm
- spinner handle - 460 mm
- ratchet, 24 teeth - 500 mm
- 3 – extensions 100 mm, 200 mm, 400 mm
- 16 – nasadon: 19, 21, 22, 23, 24, 26, 27, 29, 30, 32, 35, 36, 38, 41, 46, 50 mm
- вороток - 460 mm
- трещотка с 24 зубьями - 500 mm
- 3 удлинителя: 100 мм, 200 мм, 400 мм

Ref.	m[kg]	📦	📦	EAN
08-061	14,6	0	1	5907558404173



1/4" - 4-4.5-5-5.5-6-7-8-9-10-11-12-13-14 mm



1/4"



1/4" - 50, 100 mm



1/4"



1/4" - 150 mm



1/4" - SL4-SL5, 5-SL7  
PH1-PH2-PH3  
PZ1-PZ2-PZ3  
T10-T15-T20-T25-T30-T40  
H3-H4-H5-H6-H7-H8



1/4" - 150 mm



1/4"



1.5, 2, 2.5 mm



1/4" - 1/4"

x46



1/4"



CrV  
steel

### Klucze nasadowe

Socket wrenches / Steckschlüssel / Набор сменных головок / Ключи торцевые / Dugókulcsok / Trusa tubulare / Nástrčné kľúče / Nástrčné kľúče / Nasadni ključji / Veržlerakcio antgaliak / Nomaināmo galvu komplekts / Padrunvõlmed / Сменная насадка за ключом / Nasadni ključev / Ključevni patikači / Σετ με καριδάκια / Llaves de vaso / Chiavi a bussola / Chaves articuladas / Clefs à douilles / Dopsleutels

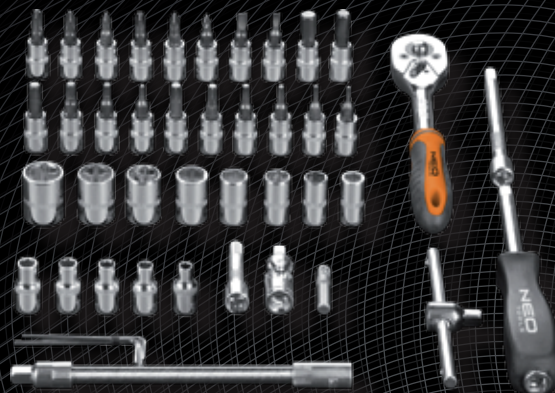

Ref.	📦	📦	EAN
08-660	1	10	5907558417319



1/2" - 10-11-12-13-14-15-16-17-18-19-22-24 mm

x20



1/2"



1/2" - 250 mm



1/2"



1/2" - 16 mm



1/2" - 13-17-19 mm



1/2"



1/2"



CrV  
steel

### Klucze nasadowe

Socket wrenches / Steckschlüssel / Набор сменных головок / Ключи торцевые / Dugókulcsok / Trusa tubulare / Nástrčné klíče / Nástrčné klíče / Nasadni ključji / Veržlerakčio antgaliai / Nomaināmo galvu komplekts / Padrunvõtmed / Сменная наконечники за ключом / Nasadni ključevi / Ključevi patikači / Σετ με καρδιάκια / Llaves de vaso / Chiavi a bussola / Chaves articuladas / Clefs à douilles / Dopsleutels



Ref.	📦	📦	EAN
08-661	1	4	5907558417357



1/2" - 8-9-10-11-12-13-14-15-16-17-18-19-20-21-22-24-27-30-32 mm

x32

1/2" - 10-12-14-15-17-19 mm

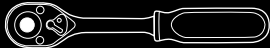

1/2"

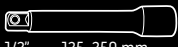

1/2" - 125, 250 mm



1/2" - 250 mm



1/2"

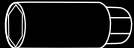

1/2" - 16, 21 mm



1/2"



CrV  
steel

### Klucze nasadowe

Socket wrenches / Steckschlüssel / Набор сменных головок / Ключи торцевые / Dugókulcsok / Trusa tubulare / Nástrčné klíče / Nástrčné klíče / Nasadni ključji / Veržlerakčio antgaliai / Nomaināmo galvu komplekts / Padrunvõtmed / Сменная наконечники за ключом / Nasadni ključevi / Ključevi patikači / Σετ με καρδιάκια / Llaves de vaso / Chiavi a bussola / Chaves articuladas / Clefs à douilles / Dopsleutels



Ref.	📦	📦	EAN
08-662	1	3	5907558417364



### Klucze nasadowe

Socket wrenches / Steckschlüssel / Набор сменных головок / Ключи торцевые / Dugókulcsok / Trusa tubulare / Nástrčné kľúče / Nástrčné ključice / Nasadni ključiči / Veržlerakčio antgaliai / Nomaināmo galvu komplekts / Padrunvõrtmed / Сменяемые наконечники за ключовые / Nasadni ključevci / Ključevci natikači / Σετ με καριδάκια / Llaves de vaso / Chiavi a bussola / Chaves articuladas / Clefs à douilles / Dopsleutels

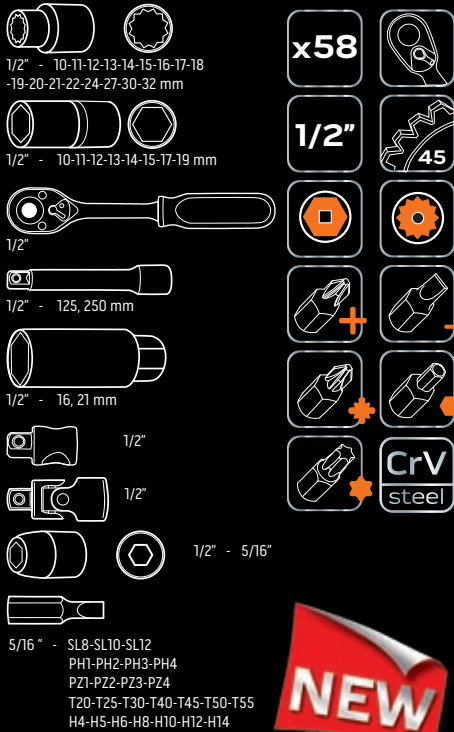

x58



1/2"



CrV  
steel



Ref.	📦	📦	EAN
08-663	1	3	5907558417296

### Klucze nasadowe

Socket wrenches / Steckschlüssel / Набор сменных головок / Ключи торцевые / Dugókulcsok / Trusa tubulare / Nástrčné kľúče / Nástrčné ključice / Nasadni ključiči / Veržlerakčio antgaliai / Nomaināmo galvu komplekts / Padrunvõrtmed / Сменяемые наконечники за ключовые / Nasadni ključevci / Ključevci natikači / Σετ με καριδάκια / Llaves de vaso / Chiavi a bussola / Chaves articuladas / Clefs à douilles / Dopsleutels

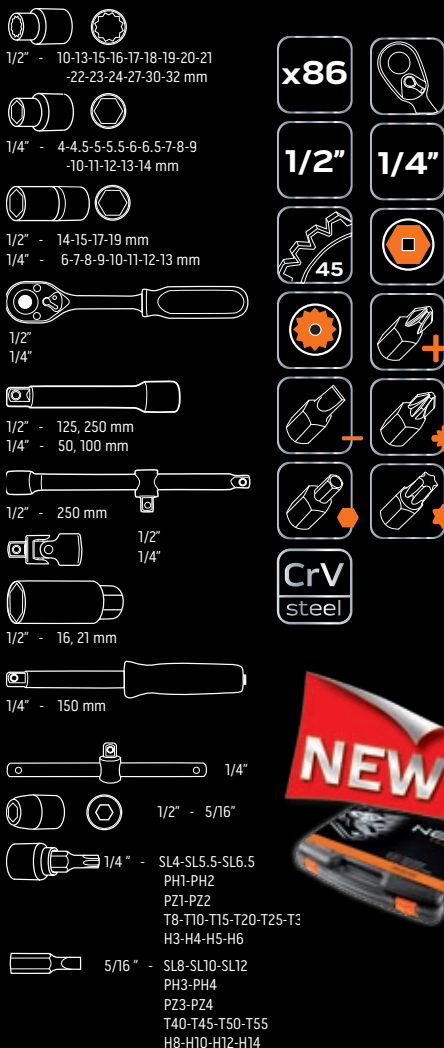

x86



1/2"

1/4"



CrV  
steel

NEW

NEW



Ref.	📦	📦	EAN
08-664	1	3	5907558417302

### Klucze nasadowe

Socket wrenches / Steckschlüssel / Набор сменных головок / Ключи торцевые / Dugókulcsok / Trusa tubulare / Nástrčné klíče / Nástrčné klíče / Nasadni ključji / Veržlerakció antgaliai / Nomaināmo galvu komplekts / Padrunvõtmed / Сменяемые наконечники за ключом / Nasadni ključevni / Ključevni patikači / Σετ με καρδιάκια / Llaves de vaso / Chiavi a bussola / Chaves articuladas / Clefs à douilles / Dopsleutels



1/2" - 10-11-12-13-14-15-16-17-18  
-19-20-21-22-23-24-27-30-32 mm



1/4" - 4-4.5-5-5.5-6-7-8-9-10-11-12-13-14 mm



1/2" - 14-15-17-19 mm  
1/4" - 6-7-8-9-10-11-12-13 mm

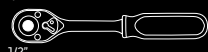

1/2" - 125, 250 mm  
1/4" - 50, 100 mm

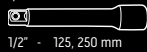

1/2" - 125, 250 mm  
1/4" - 50, 100 mm

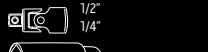

1/2" - 16, 21 mm  
1/4" - 16, 21 mm



1/2" - 250 mm  
1/4" - 150 mm



1/4" - 150 mm  
1/4" - 150 mm

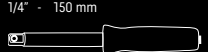

1/4" - 150 mm

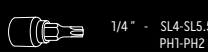

1/4" - SL4-SL5.5-SL7  
PH1-PH2  
PZ1-PZ2  
T8-T10-T15-T20-T25-T30  
H3-H4-H5-H6



1/2" - 5/16"

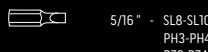

5/16" - SL8-SL10-SL12  
PH3-PH4  
PZ3-PZ4  
T40-T45-T50-T55  
H8-H10-H12-H14



1.5-2-2.5 mm  
1/4" - 1/4"

x94



1/2"

1/4"



CrV steel



Ref.	📦	📦	EAN
08-665	1	3	5907558417371

### Klucze nasadowe

Socket wrenches / Steckschlüssel / Набор сменных головок / Ключи торцевые / Dugókulcsok / Trusa tubulare / Nástrčné klíče / Nástrčné klíče / Nasadni ključji / Veržlerakció antgaliai / Nomaināmo galvu komplekts / Padrunvõtmed / Сменяемые наконечники за ключом / Nasadni ključevni / Ključevni patikači / Σετ με καρδιάκια / Llaves de vaso / Chiavi a bussola / Chaves articuladas / Clefs à douilles / Dopsleutels



1/2" - 10-11-12-13-14-15-16-17-18  
-19-20-21-22-24-27-30-32 mm



1/4" - 4-4.5-5-5.5-6-7-8-9-10  
-11-12-13-14 mm



1/2" - 14-15-17-19-22 mm  
1/4" - 6-7-8-9-10-11-12-13 mm



1/2" - E10-E11-E12-E14-E16-E18-E20-E24  
1/4" - E4-E5-E6-E7-E8



1/2" - 125, 250 mm  
1/4" - 50, 100 mm

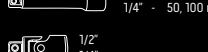

1/2" - 16, 21 mm  
1/4" - 16, 21 mm



1/2" - 250 mm  
1/4" - 150 mm



1/4" - 150 mm



1/4" - 150 mm



1/4" - SL4-SL5.5-SL6.5  
PH1-PH2  
PZ1-PZ2  
T8-T10-T15-T20-T25-T27  
H3-H4-H5-H6



1/2" - 5/16"



5/16" - SL8-SL10-SL12  
PH3-PH4  
PZ3-PZ4  
T40-T45-T50-T55-T60  
H7-H8-H10-H12-H14

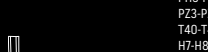

1.5-2-2.5 mm

x108



1/2"

1/4"











CrV steel



Ref.	📦	📦	EAN
08-666	1	3	5907558417340

### Klucze nasadowe

Socket wrenches / Steckschlüssel / Набор сменных головок / Ключи торцевые / Dugökücsök / Trusa tubulare / Nástrčné kľúče / Nástrčné kľúče / Nasadni ključji / Veržlerakčio antgaliai / Nomaināmo galvu komplekts / Padrunvõrted / Сменяемые наконечники за ключовые / Nasadni ključevi / Ključevi natikači / Σετ με καριδάκια / Llaves de vaso / Chiavi a bussola / Chaves articuladas / Clefs à douilles / Dopsleutels

-  1/2" - 20-21-22-24-27-30-32 mm
-  3/8" - 6-7-8-9-10-11-12-13-14-15-16-17-18-19 mm  
1/4" - 4-4.5-5-5.5-6-6.5-7-8-9-10-11-12-13 mm
-  3/8" - 13-14-15-17 mm  
1/4" - 8-9-10-12 mm
-  1/2" - 125, 250 mm  
3/8" - 75, 150 mm  
1/4" - 50
-  1/2" - 17-19-21-23 mm
-  3/8" - E8-E10-E11-E12-E14-E16-E18-E
-  3/8" - 16, 21 mm
-  3/8" (M) x 1/2" (F)  
1/4" (M) x 3/8" (F)
-  1/2" - 250 mm
-  8-9-10-11-12-13-14-17-18
-  1/2" - RM 52
-  3/8" - SL5-SL6.5  
PH1-PH2  
PZ1-PZ2  
T20-T30-T40-T45-T50-T55-TI  
H3-H4-H5-H6
-  T10H-T15H-T20H-T25H-T27H  
T30H-T40H-ST20-ST25-ST30
-  1/4"
-  1.5-2-2.5-3-4-5-6-8-10 mm
-  1/4" - 150 mm

x120

1/2"

3/8"





















1/4"



Ref.			EAN
08-667	1	2	5907558417333

## Klucze nasadowe

Socket wrenches / Steckschlüssel / Набор сменных головок / Ключи торцевые / Dugókulcsok / Trusa tubulare / Nástrčné kľúče / Nástrčné kľúče / Nasadni ključvi / Veržlerakció antgaliai / Normaināmo galvu komplekts / Padrunvõtmed / Сменная накруйница за ключове / Nasadni ključevi / Ključevi patikači / Σετ με καρδιάκια / Llaves de vaso / Chiavi a bussola / Chaves articuladas / Clefs à douilles / Dopsleutels

-  1/2" - 10-11-12-13-14-15-16-17-18-19  
-20-21-22-24-27-30-32 mm
-  3/8" - 9-10-11-12-13-14-15-16-17-18-19 mm
-  1/4" - 4-5-5.5-6-7-8-9-10-11-12-13-14 mm
-  1/2" - 10-12-13-14-17-19 mm
-  3/8" - 10-11-12-13-14-15 mm
-  1/4" - 4-5-6-7-8-9 mm
-  1/2" - 125, 250 mm
-  3/8" - 75, 150 mm
-  1/4" - 50, 100 mm
-  1/2" - 17-19-21-23 mm
-  1/2" - E20-E22-E24
-  3/8" - E10-E11-E12-E14-E16-E18
-  1/4" - E4-E5-E6-E7-E8
-  8-9-10-11-12-13-14-15-16-17-18-19 mm
-  8x10 mm 12x13 mm 17x19 mm
-  3/8" - 16, 21 mm
-  1/4" - SL4-SL5.5-SL6.5  
PH1-PH2-PH3  
PZ1-PZ2-PZ3  
T30-T40-T45-T50-T55  
H3-H4-H5-H6-H8-H10
-  1/4" - T10H-T15H-T20H-T25H-T27H  
-T30H-T40H-ST20-ST25-ST30
-  1.5-2-2.5-3-4-5-6-8-10 mm
-  1/4" - 150 mm

x150

1/2"

3/8"

1/4"



Ref.			EAN
08-668	1	2	5907558417326

### Końcówka Spline na nasadce

Spline bit / Spline-Endstück / Наконечник Spline / Наконечник „Spline” / Spline bit / Punct Spline / Nástavec Spline / Nástavec Spline / Nástavec Spline / Antgalis Spline / Uzgalis Spline / Spline-otsak / Накрайник Spline / Nastavak Spline / Nastavak Spline / Μύτη Spline / Punta Spline / Inserto Spline / Ponteiro Spline / Embout Spline / Spline eindstuk

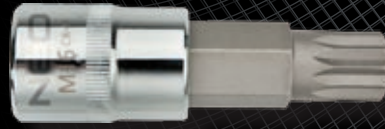

- długość -55 mm
- nasadka: CrV
- końcówka sześciokątna: stal stopowa S2
- length -55 mm
- socket: CrV
- hexagonal bit: S2 alloy steel
- длина -55 мм
- насадка: CrV
- шестигранной насадкой: легированная сталь S2

Ref.		L[mm]	☞	☝	EAN
08-730	M5	55	12	144	5907558411911
08-731	M6	55	12	144	5907558411928
08-732	M8	55	12	144	5907558411935
08-733	M10	55	12	144	5907558411942
08-734	M12	55	12	144	5907558411959
08-735	M14	55	12	144	5907558411966
08-736	M16	55	12	144	5907558411973

### Końcówka Spline na nasadce

Spline bit / Spline-Endstück / Наконечник Spline / Наконечник „Spline” / Spline bit / Punct Spline / Nástavec Spline / Nástavec Spline / Nástavec Spline / Antgalis Spline / Uzgalis Spline / Spline-otsak / Накрайник Spline / Nastavak Spline / Nastavak Spline / Μύτη Spline / Punta Spline / Inserto Spline / Ponteiro Spline / Embout Spline / Spline eindstuk

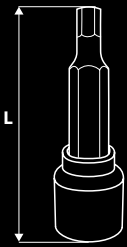

- długość -55 mm
- nasadka: CrV
- końcówka sześciokątna: stal stopowa S2
- length -55 mm
- socket: CrV
- hexagonal bit: S2 alloy steel
- длина -55 мм
- насадка: CrV
- шестигранной насадкой: легированная сталь S2

Ref.		L[mm]	☞	☝	EAN
08-740	M5	100	12	96	5907558411980
08-741	M6	100	12	96	5907558411997
08-742	M8	100	12	96	5907558412000
08-743	M10	100	12	96	5907558412017
08-744	M12	100	12	96	5907558412024
08-745	M14	100	12	96	5907558412031
08-746	M16	100	12	96	5907558412048

### Końcówki Torx na nasadce

Torx bit on socket / Torx-Einsatz auf Aufsatz / Головка сменная с насадкой Torx / Наконечник «Torx» на насадке / Torx betét tartóban / Cap tubulara cu antrenor torx / Koncovka Torx na nástavce / Koncovka Torx na nástavce / Nástavec Torx za nasadní ključ / Torcinis antgalis su laikikliu / Nomaināmā galva ar Torx uzgali / Torx-otsak radgrunil / Накрайник Torx на наставката / Nastavak Torx na karpiči / Nastavak Torx za nasadke / Καριδάκι με μύτη Torx / Vaso torx / Inserti Torx a bussola / Ponteiros Torx no bico / Embouts Torx sur ajutage / Trox eindstuk op dop

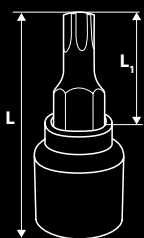

- długość -55 mm
- nasadka: stal stopowa CrV
- końcówka Torx: stal stopowa S2
- length -55 mm
- socket: CrV alloy steel
- Torx bit: S2 alloy steel
- длина -55 мм
- насадка: легированная сталь CrV
- насадка Torx: легированная сталь S2

Ref.		L[mm]	L [mm]	☞	☝	EAN
08-750	T20	55	17	12	144	5907558409604
08-751	T25	55	17	12	144	5907558409611
08-752	T27	55	17	12	144	5907558409628
08-753	T30	55	17	12	144	5907558409635
08-754	T40	55	17	12	144	5907558409642
08-755	T45	55	17	12	144	5907558409659
08-756	T50	55	17	12	144	5907558409666
08-757	T55	55	17	12	144	5907558409673
08-758	T60	55	17	12	144	5907558417388
08-759	T70	55	17	12	144	5907558417395



**NEW**

## Końcówki Torx na nasadce

Torx bit on socket / Torx-Einsatz auf Aufsatz / Головка сменная с насадкой Torx / Наконечник «Torx» на насадку / Torx betét tartóban / Cap tubulare cu antrenor torx / Końcówka Torx na nástawce / Końcówka Torx na nástawce / Nástavec Torx za nasadni ključ / Torcinis antgalis su laikikliu / Nomaināmā galva ar Torx uzgali / Torx-otsak padrunil / Накрайник Torx на наставката / Nastavak Torx na kapici / Nastavak Torx za nasadke / Καρυδάκι με μύτη Torx / Vaso torx / Inserti Torx a bussola / Ponteiros Torx na bico / Embouts Torx sur ajutage / Trox eindstuk op dop

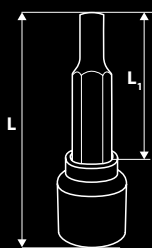

1/2"



S2 steel

CrV steel

25 years guarantee



- długość - 100 mm
- nasadka: stal stopowa CrV
- końcówka Torx: stal stopowa S2
- length - 100 mm
- socket: CrV alloy steel
- Torx bit: S2 alloy steel
- длина - 100 мм
- насадка: легированная сталь CrV
- насадка Torx: легированная сталь S2

Ref.		L[mm]	L <sub>1</sub> [mm]	⌀	⊞	EAN
08-760	T20	100	62	12	96	5907558409680
08-761	T25	100	62	12	96	5907558409697
08-762	T27	100	62	12	96	5907558409703
08-763	T30	100	62	12	96	5907558409710
08-764	T40	100	62	12	96	5907558409727
08-765	T45	100	62	12	96	5907558409734
08-766	T50	100	62	12	96	5907558409741
08-767	T55	100	62	12	96	5907558409758



## Końcówki sześciokątne na nasadce

Hexagonal bits on socket / Sechskanteinsätze auf Aufsatz / Головки шестигранные с насадкой / Наконечники шестигранные на насадку / 6-lapú betétek tartóban / Trusa capete tubulare cu antrenor / Końcówki sześciokątne na nástawce / Šestihranné końcovky na nástawce / Šestkotni nastavki za nasadni ključ / Šešiakampiai antgaliai su laikikliu / Nomaināmā galva ar sešstūra uzgaliem / Kuuskantotsakud padrunil / Шестоъгълни накрайници на наставката / Šesterokutni nastavci na kapici / Šestougaoni nastavci za nasadke / Καρυδάκι με μύτη εξάγωνες / Vasos destornilladores hexagonales / Inserti esagonali a bussola / Ponteiros hexagonais na bico / Embouts à 6 pans sur ajutage / Zeskant eindstukken op dop

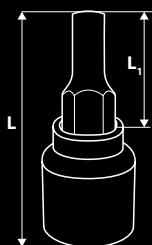

1/2"



DIN 7422

S2 steel

CrV steel

25 years guarantee

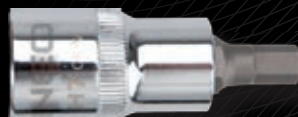

- długość - 55 mm
- nasadka: stal stopowa CrV
- końcówka sześciokątna: stal stopowa S2
- length - 55 mm
- socket: CrV alloy steel
- hexagonal bit: S2 alloy steel
- длина - 55 мм
- насадка: легированная сталь CrV
- шестигранной насадкой: легированная сталь S2

Ref.		L[mm]	L <sub>1</sub> [mm]	⌀	⊞	EAN
08-770	H5	55	17	12	144	5907558409765
08-771	H6	55	17	12	144	5907558409772
08-772	H7	55	17	12	144	5907558409789
08-773	H8	55	17	12	144	5907558409796
08-774	H10	55	17	12	144	5907558409802
08-775	H12	55	17	12	144	5907558409819
08-776	H14	55	17	12	144	5907558409826
08-777	H17	55	17	12	144	5907558409833
08-778	H19	55	17	12	144	5907558409840



## Końcówki sześciokątne na nasadce

Hexagonal bits on socket / Sechskanteinsätze auf Aufsatz / Головки шестигранные с насадкой / Наконечники шестигранные на насадку / 6-lapú betétek tartóban / Trusa capete tubulare cu antrenor / Końcówki sześciokątne na nástawce / Šestihranné końcovky na nástawce / Šestkotni nastavki za nasadni ključ / Šešiakampiai antgaliai su laikikliu / Nomaināmā galva ar sešstūra uzgaliem / Kuuskantotsakud padrunil / Шестоъгълни накрайници на наставката / Šesterokutni nastavci na kapici / Šestougaoni nastavci za nasadke / Καρυδάκι με μύτη εξάγωνες / Vasos destornilladores hexagonales / Inserti esagonali a bussola / Ponteiros hexagonais na bico / Embouts à 6 pans sur ajutage / Zeskant eindstukken op dop

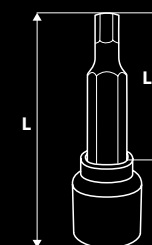

1/2"



DIN 7422

S2 steel

CrV steel

25 years guarantee



- długość - 100 mm
- nasadka: stal stopowa CrV
- końcówka sześciokątna: stal stopowa S2
- length - 100 mm
- socket: CrV alloy steel
- hexagonal bit: S2 alloy steel
- длина - 100 мм
- насадка: легированная сталь CrV
- шестигранной насадкой: легированная сталь S2

Ref.		L[mm]	L <sub>1</sub> [mm]	⌀	⊞	EAN
08-780	H5	100	62	12	96	5907558409857
08-781	H6	100	62	12	96	5907558409864
08-782	H7	100	62	12	96	5907558409871
08-783	H8	100	62	12	96	5907558409888
08-784	H10	100	62	12	96	5907558409895





### Końcówki sześciokątne na nasadce

Hexagonal bits on socket / Sechskanteinsätze auf Aufsatz / Головки шестиугольные с насадкой / Наконечники шестиугольные на насадку / 6-lapú betétek tartóban / Trusa capete tubulare cu antrenor / Koncovky šestihřanné na nástavce / Šesthranné koncovky na nástavce / Šestkotní nastavky za nasadní ključ / Šešiakampiai antgaliai su laikikliu / Nomaināmā galva ar sešstūra uzgaliem / Kuuskantotsakud padrunil / Шестъъгълни накрайници на наставката / Šesterokutni nastavci na kapici / Šestougaoni nastavci za nasadke / Καρυδάκι με μύτες εξάγωνες / Vasos destornilladores hexagonales / Inserti esagonalni a bussola / Ponteiros hexagonais no bico / Embouts à 6 pans sur ajutage / Zeskant eindstukken op dop



- długość - 55 mm
- 9 końcówek - H4, H5, H6, H7, H8, H10, H12, H14, H17
- length - 55 mm
- 9 bits - H4, H5, H6, H7, H8, H10, H12, H14, H17

Ref.	m[kg]	L[mm]	☞	☞	EAN
08-705	1,1	55	0	12	5907558409253



- длина - 55 мм
- 9 насадок - H4, H5, H6, H7, H8, H10, H12, H14, H17

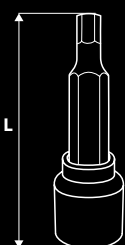

### Końcówki sześciokątne na nasadce

Hexagonal bits on socket / Sechskanteinsätze auf Aufsatz / Головки шестиугольные с насадкой / Наконечники шестиугольные на насадку / 6-lapú betétek tartóban / Trusa capete tubulare cu antrenor / Koncovky šestihřanné na nástavce / Šesthranné koncovky na nástavce / Šestkotní nastavky za nasadní ključ / Šešiakampiai antgaliai su laikikliu / Nomaināmā galva ar sešstūra uzgaliem / Kuuskantotsakud padrunil / Шестъъгълни накрайници на наставката / Šesterokutni nastavci na kapici / Šestougaoni nastavci za nasadke / Καρυδάκι με μύτες εξάγωνες / Vasos destornilladores hexagonales / Inserti esagonalni a bussola / Ponteiros hexagonais no bico / Embouts à 6 pans sur ajutage / Zeskant eindstukken op dop



- długość - 100 mm
- 9 końcówek - H4, H5, H6, H7, H8, H10, H12, H14, H17
- length - 100 mm
- 9 bits - H4, H5, H6, H7, H8, H10, H12, H14, H17

Ref.	m[kg]	L[mm]	☞	☞	EAN
08-706	1,7	100	0	12	5907558409260



- длина - 100 мм
- 9 насадок - H4, H5, H6, H7, H8, H10, H12, H14, H17

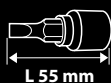

### Końcówki Torx na nasadce

Torx bit on socket / Torx-Einsatz auf Aufsatz / Головка сменная с насадкой Torx / Наконечник «Torx» на насадку / Torx betét tartóban / Cap tubulara cu antrenor / Koncovka Torx na nástavce / Koncovka Torx na nástavce / Nastavke Torx za nasadní ključ / Torcinis antgalis su laikikliu / Nomaināmā galva ar Torx uzgali / Torx-otsak padrunil / Накрайник Torx на наставката / Nastavak Torx na kapici / Nastavak Torx za nasadke / Καρυδάκι με μύτη Torx / Vaso torx / Inserti Torx a bussola / Ponteiros Torx no bico / Embouts Torx sur ajutage / Trox eindstukken op dop



- długość - 55 mm
- 9 końcówek - T20, T25, T27, T30, T40, T45, T50, T55, T60
- length - 55 mm
- 9 bits - T20, T25, T27, T30, T40, T45, T50, T55, T60

Ref.	m[kg]	☞	☞	EAN
08-707	1,0	0	12	5907558409277



- длина - 55 мм
- 9 насадок - T20, T25, T27, T30, T40, T45, T50, T55, T60



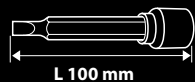

L 100 mm

1/2"



x9

S2  
steel

CrV  
steel

25  
years  
guarantee

### Końcówki Torx na nasadce

Torx bit on socket / Torx-Einsatz auf Aufsatz / Головка сменная с насадкой Torx / Наконечник «Torx» на насадку / Torx betét tartóban / Cap tubulara cu antrenor torx / Końcówka Torx na nąstawce / Końcówka Torx na nąstawce / Nastavek Torx za nasadni ključ / Torcinis antgalis su laikikliu / Nomaināmā galva ar Torx uzgali / Torx-otsak padrunil / Накрайник Torx на наставката / Nastavak Torx na kapići / Nastavak Torx za nasadke / Καρυδάκι με μύτη Torx / Vaso torx / Inerti Torx a bussola / Ponteiros Torx na bico / Embouts Torx sur ajutage / Trox eindstukken op dop



- długość - 100 mm

- 9 końcówek - T20, T25, T27, T30, T40, T45, T50, T55, T60

- length - 100 mm

- 9 bits - T20, T25, T27, T30, T40, T45, T50, T55, T60

- длина - 100 мм

- 9 насадок - T20, T25, T27, T30, T40, T45, T50, T55, T60

Ref.	m[kg]	☞	☝	EAN
08-708	1,6	0	12	5907558409284

### Klucze nasadowe TORX

TORX sockets / Steckschlüssel TORX / Головки сменные Torx / Ключи торцевые «TORX» / TORX dugákulcs készlet / Chei tubulare TORX / Nástrčné kľúče TORX / Klúče nástrčné torxové / Ključī nasadni TORX / Torcinių galvučių komplektas / TORX uztaucamās galatslēgas / TORX padrunid / Комплекти инструменти тип TORX / Nasadni TORX ključevi / Nasadni ključevi TORX / Καρυδάκια TORX / Llave de vaso TORX / Chiavi a snodo TORX / Chaves articuladas TORX / Cles a douille TORX / TORX dopsleutels

x9



1/2"

CrV  
steel



- E10, E11, E12, E14, E16, E18, E20, E22, E24

Ref.	☞	☝	EAN
08-649	1	15	5907558417074

### Końcówki i nasadki torx

Torx bits and socket set / Torx-Aufsätze / Наконечники и головки торцевые Torx / Набор жпал та насадок «torx» / Torx kulcs készlet / Set canule "torx" și fixări / Bity a nąstawce Torx / Súprava klúčov torx(bity, klúče, hlavice) / Garnitura nastavkov z vpenjalom / Antgalių Torx ir galvučių rinkinys / Torx atslėgu un micinų komplekts / "Torx" otsikute ja padrunite komplekt / Вложки и накрайници / Set Nasadnih ključeva i biceva / Set biceva i gedara / Συλλογή από μύτες και καρυδάκια / Puntas destornilladoras y vasos TORX / Punte e boccole torx / Ponteiros e Bocais Torx / Embouts et douilles Torx / Torx eindstukken en doppen



x34



3/8"

S2  
steel

CrV  
steel



- E4, E5, E6, E7, E8, E10, E11, E12, E14, E16, E18, E20

- T10, T15, T20, T25, T27, T30, T40, T45, T50, T55, T60

- TT10, TT15, TT20, TT25, TT27, TT30, TT40, TT45, TT50, TT55

Ref.	☞	☝	EAN
08-711	1	12	5907558417111

**NEW**

x38



1/4"

1/2"

S2  
steel

CrV  
steel

### Końcówki wkrętakowe

Driver bits / Einsätze für Schraubendreher / Насадки / Наконечники викруток / Csavarhúzó betétek / Set biti / Šroubovákové nástavce / Skrutkovacie nástavce / Nastavki za izvijače / Atsuktuvo antgaliai / Skruvgrieža uzgāļi / Kruvikeerajaotsakud / Накраїтниця за отвертка / Nastavci za odvijač / Nastavci za odvijač / Καταβιδόμενες / Puntas destornilladoras / Inserti per avvitare / Ponteiros Chave de fenda / Embouts de tournevis / Schroevendraaierendstukken



- H7, H10, H11, H13, H14, H17, H19, H22, H24
- TS10, TS15, TS20, TS25, TS27, TS30, TS40, TS45, TS50
- T30, T40, T45, T50, T55, T60, T70, T80
- M9, M10, M12, M14, M16
- R7, R8, R9, R10
- H5

Ref.			EAN
08-710	1	3	5907558417104

**NEW**

x8



1/2"

CrMo  
steel

### Klucze udarowe torx

Impact Torx bit socket set / Torx-Schlagschrauber-Satz / Набор ударных торцовых ключей Torx / Набор ключей ударных «Torx» / Torx gépi kulcsok / Chei cu impact torx / Nástrčné klíče torx / Rázové klíče torx / Udarni nasadni ključ Torx / Smūginiai raktai „TORX” / Triecienatslēgas torx / Torx-löökvõtmed / Ударни ключове torx / udarni ključevi torx / Udarni ključevi torx / Σετ κρουσικά μπουλονόκλειδα Torx / Llaves de impacto torx / Bussolé torx / Jogo de chaves de percussão torx / Clés à choc torx / Torx slagsleutels



- T25, T27, T30, T40, T45, T50, T55, T60

Ref.			EAN
08-712	1	20	5907558418620

### Klucz sześciokatny

Hex key / Sechskantschlüssel / Ключи шестигранные / Ключ шестигранный / Imbusz kulcs / Cheie cu șase laturi / Klíč šestihřanný / Ključ imbusový / Inbus ključ / Šešakampis raktas / Seškanšu atslēga / Kuuskant-mutrivõtiti / Лимбуси 8тт. / Ključ imbus / Kluc imbus / Εξαγωνικά κλειδιά / Llave hexagonal / Chiave esagona / Chave hexagonal / Clef hexagonale / Zeskantsleutel



CrV  
steel

25  
years  
guarantee

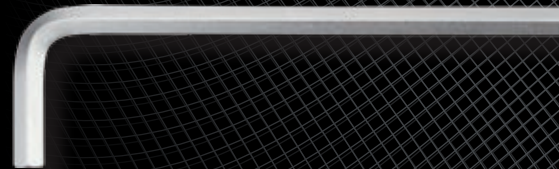

Ref.	⊙ [mm]	L [mm]	L <sub>1</sub> [mm]	⊞	⊞	EAN
09-530	1.5	77	14	375	1500	5907558414004
09-531	2.0	81	16	375	1500	5907558414011
09-532	2.5	87	18	375	1500	5907558414028
09-533	3.0	94	20	375	1500	5907558414035
09-534	4.0	103	24	250	1000	5907558414042
09-535	4.5	108	26	250	1000	5907558414059
09-536	5.0	115	28	250	500	5907558414066
09-537	5.5	122	30	250	500	5907558414073
09-538	6.0	129	32	250	500	5907558414080
09-539	7.0	136	34	150	300	5907558414097
09-540	8.0	147	36	150	300	5907558414103
09-541	9.0	159	38	100	200	5907558414110
09-542	10.0	170	40	100	200	5907558414127
09-543	12.0	190	45	50	100	5907558414134
09-544	13.0	205	48	50	100	5907558414141
09-545	14.0	216	54	50	100	5907558414158
09-546	17.0	245	63	25	50	5907558414165

### Klucz Torx

Torx key / Torx-Schlüssel / Ключи Torx / Ключ шестигранный «torx» / Torx kulcs készlet / Chei de tip "torx" / Klíče Torx / Súprava torx klíčův (krátke) / Garnitura ključev torx / Torx raktu komplektas / Torx atslēgu komplekts / "Torx" vōtmete komplekt / Лимбуси компл. / Ključ imbus torx set / Kluc imbus set / Συλλογή κλειδιών Torx / Llaves torx / Chiavi torx / Chaves torx / Clefs Torx / Torxleutel



CrV  
steel

25  
years  
guarantee



Ref.	⊙	L [mm]	L <sub>1</sub> [mm]	⊞	⊞	EAN
09-550	T10	77	14	375	1500	5907558414172
09-551	T15	84	16	375	1500	5907558414189
09-552	T20	92	18	375	1500	5907558414196
09-553	T25	101	20	250	1000	5907558414202
09-554	T27	111	24	125	500	5907558414219
09-555	T30	122	28	125	500	5907558414226
09-556	T40	136	32	125	500	5907558414233
09-557	T45	152	36	150	300	5907558414240
09-558	T50	176	40	100	200	5907558414257
09-559	T55	183	44	100	200	5907558414264

### Klucze sześciokątne

Hex key set / Sechskantschlüssel / Ключи шестигранные / Ключ шестигранный / Imbusz kulcs készlet / Set chei cu șase laturi / Šestihřanný klíč / Súprava imbus klíčův (dlhá) / Garnitura inbus ključev / Šešakampis raktu komplektas / Seškanšu atslēgu komplekts / Kuuskant-mutrivõtmete komplekt / Лимбуси компл. / Ključ imbus set / Kluc imbus set / Συλλογή εξαγωνικών κλειδιών / Llaves Allen / Chiavi esagone / Chaves hexagonais / Clefs à 6 pans / Zeskantsleutels



x7

DIN  
911

ISO  
2936

S2  
steel

25  
years  
guarantee



- końcówki sześciokątne: 1.5, 2, 2.5, 3, 4, 5, 6 mm  
- hexagonal tips: 1.5, 2, 2.5, 3, 4, 5, 6 mm  
- наконечники шестигульные: 1.5, 2, 2.5, 3, 4, 5, 6 мм

⊙ [mm]	L [mm]	L <sub>1</sub> [mm]
1.5	63	15
2.0	75	17
2.5	87	20
3.0	90	23
4.0	100	27
5.0	116	32
6.0	137	37

Ref.	⊞	⊞	EAN
09-517	12	48	5907558410273



x9

DIN  
911

ISO  
2936

SUPER HARD  
SNCM+V  
steel

25  
years  
guarantee

### Klucze sześciokątne

Hex key set / Sechskantschlüssel / Ключи шестигранные / Ключ шестигранный / Imbuskulcs készlet / Set chei cu șase laturi / Šestihranný klíč / Súprava imbus klúčov (dlh) / Garnitura imbus ključev / Šešiakamprių raktų komplektas / Seškanšu atslēgu komplekts / Kuuskant-mutrivõtmete komplekt / Лумбусу компл. / Ključ imbus set / Ključ imbus set / Συλλογή εξαγωνικών κλειδίων / Llaves Allen / Chiavi esagone / Chaves hexagonais / Clefs à 6 pans / Zeskantsleutels

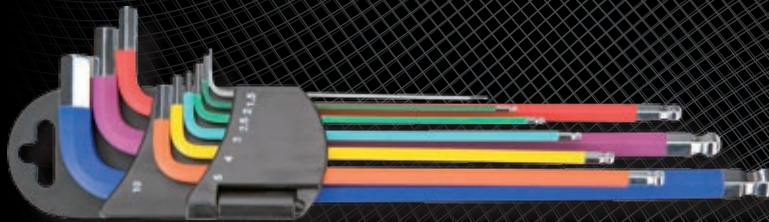

⊙	L[mm]	L <sub>1</sub> [mm]
1.5	91	16
2.0	103	19
2.5	115	20
3.0	130	23
4.0	145	29
5.0	166	35
6.0	188	38
8.0	208	43
10.0	230	50

- kuliste końcówki o kącie roboczym do 30 stopni
- kolorowy kod ułatwiający wybór rozmiaru
- końcówki sześciokątne: 1.5, 2, 2.5, 3, 4, 5, 6, 8, 10 mm
- SNCM+V wysoko gatunkowa stal stopowa

- rounded tips with working angle of up to 30 degrees
- color-coded for easy size selection
- hexagonal tips: 1.5, 2, 2.5, 3, 4, 5, 6, 8, 10 mm
- SNCM+V extra-fine alloy steel

- наконечники шаровидные, рабочий угол 30°
- цветовая кодировка - удобный выбор размера
- наконечники шестигранные: 1.5, 2, 2.5, 3, 4, 5, 6, 8, 10 мм
- SNCM+V высококачественная легированная сталь

Ref.	📦	📦	EAN
09-512	6	36	5907558403428

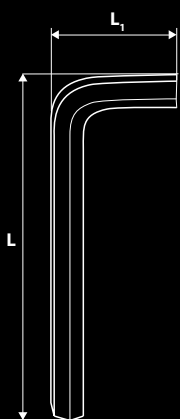

x8

ISO  
2936

S2  
steel

25  
years  
guarantee

### Klucze sześciokątne

Hex key set / Sechskantschlüssel / Ключи шестигранные / Ключ шестигранный / Imbuskulcs készlet / Set chei cu șase laturi / Šestihranný klíč / Súprava imbus klúčov (dlh) / Garnitura imbus ključev / Šešiakamprių raktų komplektas / Seškanšu atslēgu komplekts / Kuuskant-mutrivõtmete komplekt / Лумбусу компл. / Ključ imbus set / Ključ imbus set / Συλλογή εξαγωνικών κλειδίων / Llaves Allen / Chiavi esagone / Chaves hexagonais / Clefs à 6 pans / Zeskantsleutels



⊙	L[mm]	L <sub>1</sub> [mm]
2.0	85	18
2.5	90	20
3.0	97	23
4.0	106	28
5.0	118	30
6.0	138	36
8.0	159	40
10.0	180	46

- kuliste końcówki o kącie roboczym do 30 stopni
- końcówki sześciokątne: 2, 2.5, 3, 4, 5, 6, 8, 10 mm

- rounded tips with working angle of up to 30 degrees
- hexagonal tips: 2, 2.5, 3, 4, 5, 6, 8, 10 mm

- наконечники шаровидные, рабочий угол 30°
- наконечники шестигранные: 2, 2.5, 3, 4, 5, 6, 8, 10 мм

Ref.	📦	📦	EAN
09-513	6	36	5907558403411

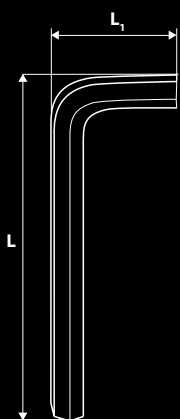

x8

S2  
steel

25  
years  
guarantee

### Klucze Torx

Torx key wrench set / Torx-Schlüssel / Ключи Torx / Ключи "Torx" / Torx kulcs készlet / Set chei de tip "torx" / Klíče Torx / Súprava Torx klúčov / Garnitura ključev torx / Raktai TORX / Torx atslēgu komplekts / "Torx" mutrivõtmete komplekt / Лумбусу компл. / Ključ imbus / Ключи Torx / Llaves torx / Chiavi torx / Chaves torx / Clefs Torx / Torxslutels



⊙	L[mm]	L <sub>1</sub> [mm]
TT10	88	20
TT15	93	22
TT20	98	23
TT25	105	24
TT30	119	30
TT40	130	32
TT45	144	37
TT50	160	40

- z otworem
- zakres: TT10, TT15, TT20, TT25, TT27, TT30, TT40, TT45, TT50

- tamperproof
- range: TT10, TT15, TT20, TT25, TT27, TT30, TT40, TT45, TT50

- с отверстием
- диапазон: TT10, TT15, TT20, TT25, TT27, TT30, TT40, TT45, TT50

Ref.	📦	📦	EAN
09-514	6	36	5907558403428

### Klucze sześciokątne

Hex key set / Sechskantschlüssel / Ключи шестигранные / Ключ шестигранный / Imbuskulcs készlet / Set chei cu șase laturi / Šestihranny klíč / Súprava imbus ključov (dlhé) / Garnitura imbus ključev / Šešakamriji raktični kompletas / Seškanšu atslēgu komplekts / Kuuskant-mutrivõtmete komplekt / Лумбџуи компл. / Ključ imbus set / Ključ imbus set / Συλλογή εξαγωνικών κλειδίων / Llaves Allen / Chiavi esagone / Chaves hexagonais / Clefs à 6 pans / Zeskantsleutels



x9

DIN 911

ISO 2936

S2 steel

25 years guarantee

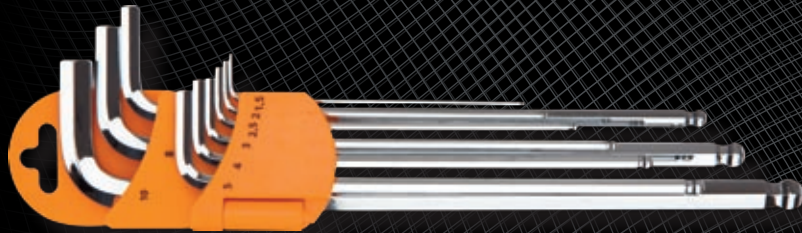
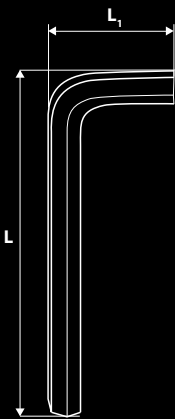

- z końcówką kulistą i magnetyczną
- magnet ball ended
- с магнитным наконечником
- zakres: 1.5, 2, 2.5, 3, 4, 5, 6, 8, 10 mm
- range: 1.5, 2, 2.5, 3, 4, 5, 6, 8, 10 mm
- диапазон: 1.5, 2, 2.5, 3, 4, 5, 6, 8, 10 мм

Ø	L[mm]	L <sub>1</sub> [mm]
1.5	92	15
2.0	100	18
2.5	114	20
3.0	127	22
4.0	143	28
5.0	164	31
6.0	185	37
8.0	205	43
10.0	235	47

Ref.	📦	📦	EAN
09-515	12	48	5907558409314

### Klucze Torx

Torx key wrench set / Torx-Schlüssel / Ключи Torx / Ключи "Torx" / Torx kulcs készlet / Set chei de tip "torx" / Klíče Torx / Súprava Torx ključov / Garnitura ključev torx / Raktični TORX / Torx atslēgu komplekts / "Torx" mutrivõtmete komplekt / Лумбџуи компл. / Ključ imbus / Кλειδιά Torx / Llaves torx / Chiavi torx / Chaves torx / Clefs Torx / Torxleutels



x9

S2 steel

25 years guarantee

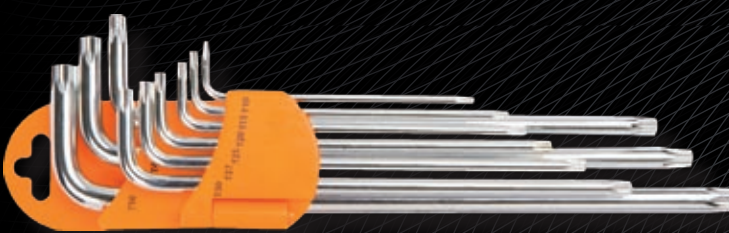
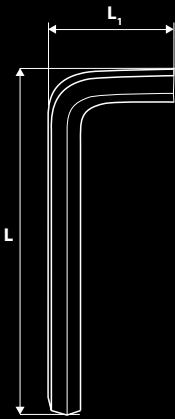

- z końcówką magnetyczną
- magnet end
- с магнитным наконечником
- zakres: T10, T15, T20, T25, T27, T30, T40, T45, T50
- range: T10, T15, T20, T25, T27, T30, T40, T45, T50
- диапазон: T10, 15, 20, 25, 27, 30, 40, 45, 50

	L[mm]	L <sub>1</sub> [mm]
T10	89	20
T15	105	22
T20	115	23
T25	130	25
T27	146	30
T30	167	35
T40	184	38
T45	204	45
T50	226	50

Ref.	📦	📦	EAN
09-516	12	48	5907558409321

### Klucze sześciokątne

Hex key set / Sechskantschlüssel / Ключи шестигранные / Ключ шестигранный / Imbuskulcs készlet / set chei cu șase laturi / Šestihranny klíč / Súprava imbus ključov (dlhé) / Garnitura imbus ključev / Šešakamriji raktični kompletas / Seškanšu atslēgu komplekts / Kuuskant-mutrivõtmete komplekt / Лумбџуи компл. / Ključ imbus set / Ključ imbus set / Συλλογή εξαγωνικών κλειδίων / Llaves Allen / Chiavi esagone / Chaves hexagonais / Clefs à 6 pans / Zeskantsleutels



x8

ISO 2936

CrV steel

25 years guarantee

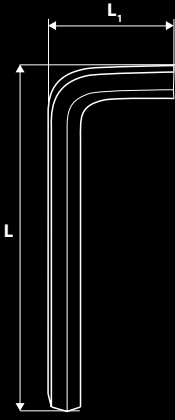

Ø	L[mm]	L <sub>1</sub> [mm]
2.0	85	18
2.5	90	20
3.0	97	23
4.0	106	28
5.0	118	30
6.0	138	36
8.0	159	40
10.0	180	46

- kuliste końcówki o kącie roboczym do 30 stopni
- rounded tips with working angle of up to 30 degrees
- наконечники шаровидные, рабочий угол 30°
- końcówki sześciokątne: 2, 2.5, 3, 4, 5, 6, 8, 10 mm
- hexagonal tips: 2, 2.5, 3, 4, 5, 6, 8, 10 mm
- наконечники шестигранные: 2, 2.5, 3, 4, 5, 6, 8, 10 мм

Ref.	📦	📦	EAN
09-523	6	36	5907558414288

### Klucze sześciokątne

Hex key set / Sechskantschlüssel / Ключи шестигранные / Ключ шестигранный / Imbuskulcs készlet / set chei cu șase laturi / Šestihranný klíč / Súprava imbus klíčov (dlhé) / Garnitura imbus ključev / Šešiacamprių raktų komplektas / Seškanšu atslēgu komplekts / Kuuskant-mutrivõtmete komplekt / Лимбусу компл. / Ključ imbus set / Ključ imbus set / Συλλογή εξαγωνικών κλειδίων / Llaves Allen / Chiavi esagone / Chaves hexagonais / Clefs à 6 pans / Zeskantsleutels

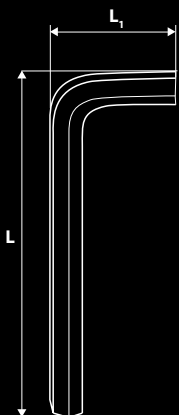

x9

CrV  
steel

DIN  
911

25  
years  
guarantee

ISO  
2936

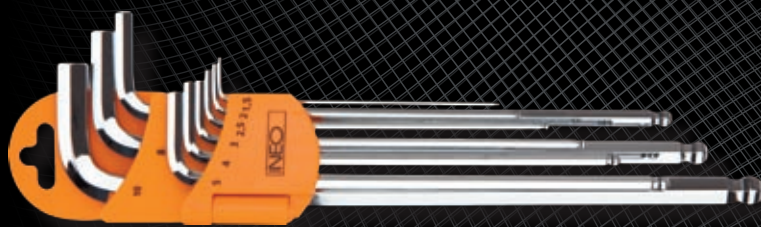

- z końcówką kulistą i magnetyczną
- zakres: 1.5, 2, 2.5, 3, 4, 5, 6, 8, 10 mm
- magnet ball ended
- range: 1.5, 2, 2.5, 3, 4, 5, 6, 8, 10 mm
- с магнитным наконечником
- диапазон: 1.5, 2, 2.5, 3, 4, 5, 6, 8, 10 мм

Ref.			EAN
09-525	12	48	5907558414301

⊙	L[mm]	L <sub>1</sub> [mm]
1.5	92	15
2.0	100	18
2.5	114	20
3.0	127	22
4.0	143	28
5.0	164	31
6.0	185	37
8.0	205	43
10.0	235	47

### Klucze Torx

Torx key wrench set / Torx-Schlüssel / Ключи Torx / Ключи "Torx" / Torx kulcs készlet / Set chei de tip "torx" / Klíče Torx / Súprava Torx klíčov / Garnitura ključev torx / Raktai TORX / Torx atslēgu komplekts / "Torx" mutrivõtmete komplekt / Лимбусу компл. / Ključ imbus / Κλειδιά Torx / Llaves torx / Chiavi torx / Chaves torx / Clefs Torx / Torxsleutels

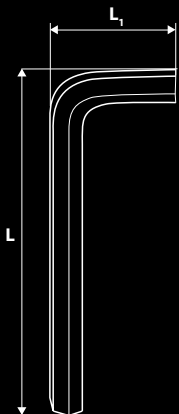

x8

CrV  
steel

25  
years  
guarantee



- z otworem
- zakres: TT10, TT15, TT20, TT25, TT30, TT40, TT45, TT50
- tamperproof
- range: TT10, TT15, TT20, TT25, TT30, TT40, TT45, TT50
- с отверстием
- диапазон: TT10, TT15, TT20, TT25, TT30, TT40, TT45, TT50

Ref.			EAN
09-524	6	36	5907558414295

⊙	L[mm]	L <sub>1</sub> [mm]
TT10	88	20
TT15	93	22
TT20	98	23
TT25	105	24
TT30	119	30
TT40	130	32
TT45	144	37
TT50	160	40

### Klucze Torx

Torx key wrench set / Torx-Schlüssel / Ключи Torx / Ключи "Torx" / Torx kulcs készlet / Set chei de tip "torx" / Klíče Torx / Súprava Torx klíčov / Garnitura ključev torx / Raktai TORX / Torx atslēgu komplekts / "Torx" mutrivõtmete komplekt / Лимбусу компл. / Ključ imbus / Κλειδιά Torx / Llaves torx / Chiavi torx / Chaves torx / Clefs Torx / Torxsleutels

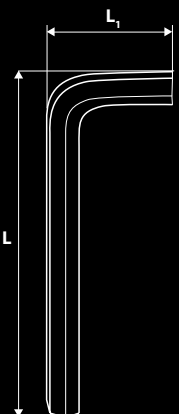

x9

CrV  
steel

25  
years  
guarantee

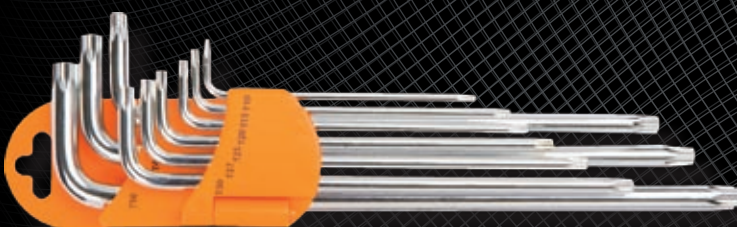

- z końcówką magnetyczną
- zakres: T10, T15, T20, T25, T27, T30, T40, T45, T50
- magnet end
- range: T10, T15, T20, T25, T27, T30, T40, T45, T50
- с магнитным наконечником
- диапазон: T10, T15, T20, T25, T27, T30, T40, T45, T50

Ref.			EAN
09-526	12	48	5907558414318

⊙	L[mm]	L <sub>1</sub> [mm]
T10	89	20
T15	105	22
T20	115	23
T25	130	25
T27	146	30
T30	167	35
T40	184	38
T45	204	45
T50	226	50

## Klucze pięciokątne

Pentagonal wrenches / Fünfkantschlüssel / Пятигранные ключи / Ключи-звездочки / 5 lapú kulcsok / Chei pentagonale / Pëthiranné klíče / Páthiranné klíče / Ключи-звезда / Penkiakampiai raktai / Piecstūra atslēgas / Viiskantvõtmed / Петельные ключеве / Peterokutni ključevi / Petougaoni ključ / Πεντάγωνα κλειδιά / Llaves pentagonales / Chiavi pentagonali / Chaves de cinco ângulos / Clefs à 5 pans / Vijfkant sleutels



- z otworem
- zakres: TS10, TS15, TS20, TS25, TS27, TS30, TS40, TS45, TS50
- tamperproof
- range: TS10, TS15, TS20, TS25, TS27, TS30, TS40, TS45, TS50
- с отверстием
- диапазон: TS10, TS15, TS20, TS25, TS27, TS30, TS40, TS45, TS50

☆	L [mm]	L <sub>1</sub> [mm]
TS10	92	18
TS15	113	20
TS20	116	23
TS25	130	25
TS27	145	30
TS30	165	35
TS40	186	40
TS45	208	45
TS50	232	50

Ref.	📦	📦	EAN
09-520	1	36	5907558410280

## Klucz dynamometryczny

Torque wrench / Drehmomentschlüssel / Ключ динамометрический / Ключ динамометричный / Nyomatékkulcs / Cheie dinamometrică / Dynamometrický klíč / Dynamometrický klíč / Dinamometrični ključ / Dinamometrinis raktas / Dinamometriska atslēga / Dünamoetriline võti / Динамометричен ключ / Dinamometrički ključ / Obrtni ključ / Динамометрико κλειδί / Llave dinamométrica / Chiave dinamometrica / Chave dinamométrica / Clef dynamométrique / Dynamometrische sleutel

CrV  
steel



- mocny mechanizm zapadkowy 24 zęby
- dokładność +/- 4%
- łatwe nastawianie żądanych wartości - okienko ze skalą
- pierścień blokujący
- klucza nie należy przechowywać ze sprężyną ustawioną na maksymalne wartości
- durable ratchet gear with 24 teeth
- precision +/- 4%
- easy setting of required values - window with scale
- blocking ring
- do not store the wrench with the spring set to maximum values
- прочный реверсивный механизм на 24 зуба
- точность +/- 4%
- удобная настройка требуемых величин - окошечко со шкалой
- кольцо блокировки
- при хранении пружина не должна быть установлена на максимальную величину

Ref.	Zakres/Range/Диапазон [Nm]	Długość/Length/Длина [mm]	Kwadrat/Square/Квадрат	m[kg]	📦	📦	EAN
08-803	10-60	390	3/8"	1,0	0	12	5907558408553
08-804	20-100	420	3/8"	1,2	0	12	5907558406313
08-805	40-200	525	1/2"	2,0	0	10	5907558406320
08-806	60-320	600	1/2"	2,2	0	6	5907558406337

## Elektroniczny klucz dynamometryczny

Digital torque wrench / Elektronischer Drehmomentschlüssel / Электронный динамометрический ключ / Ключ динамометрический электронный / Elektronikus nyomatékkulcs / Cheie dinamometrică electronică / Elektronický dynamometrický klíč / Elektronický dynamometrický klíč / Elektroniski ključ dinamometer / Elektroninis dinamometrinis raktas / Elektroniskā dinamometriska atslēga / Elektrooniline dünamoetriline võti / Электронен динамометричен ключ / Dinamometarski elektronski ključ / Elektronski dinamometarski ključ / Ηλεκτρονικό δυναмомετρικό κλειδί / Llave dinamométrica eléctrica / Chiave elettronica dinamometrica / Chave dinamométrica automática / Clef dynamométrique électronique / Dynamometrisch digitaal sleutel

1/2"



- Elektroniczna nastawa i pomiar wartości momentu - 10 presetów z możliwością wstępnej nastawy wartości zadanej
- Sygnalizacja dochodzenia i osiągnięcia zadanej wartości momentu
- Pamięć pomiarów
- Długość ramienia 580 mm
- Prosta wymiana baterii typu AA x 3
- Electronic setting and measuring of the torque - 10 presets with the possibility to preset set value
- Approaching and reaching torque set value signalization
- Measurement memory
- Arm length: 580 mm
- Simple AA x 3 battery replacement
- Электронная установка и измерение момента, возможность предварительного задания 10 значений крутящего момента (Pre-set)
- Высвечивание и сохранение значения прикладываемого момента
- Память последних затяжек
- Длина 580 мм
- Простая замена батареек типа AA x 3

Ref.	Zakres/Range/Диапазон [Nm]	Kwadrat/Square/Квадрат	📦	📦	EAN
08-820	20-200	1/2"			5907558417081

### Dynamometryczny adapter elektroniczny

Digital torque adapter / Elektronischer Kraftmessadapter / Адаптер динамометрический цифровой / Адаптер динамометричний електронний / Elektronikus nyomatékkulcs-adapter / Adaptor elektronik dinamometric, la boraci / Dynamometrický elektronický adaptér / Dynamometrický elektronický adaptér / Momentni elektronski adapter / Jungtis dinamometrinė, skaitmeninė / Dinamometriskais elektroniskais adapteris / Elektrooniline dünamomeetriadapter / Динамометричен електронен адаптер / Dinamometrički elektrónski adapter / Dinamometarski električni adapter / Προσαρμογέας δυναμομετρικός ψηφιακός / Adaptador electrónico dinamométrico / Adattatore elettronico dinamometrico / Adaptador electrónico dinamométrico / Adaptateur dynamométrique électronique / Dynamometrisch digitaal adapter



- dokładność pomiaru: +/- 2%
- pamięć pomiaru - 50 ostatnich wskazań
- rozdzielczość wyświetlacza: 0.1
- zakres wskazań
- tryby wskazań: bieżący i szczytowy
- zasilanie - 1 litowa bateria CR2032 (3V)

- measurement accuracy: +/- 2%
- measurement memory - 50 last values
- display resolution: 0.1
- readout range
- readout modes: current and peak value
- power supply - one CR2032 lithium battery (3V)

- Точность измерений: +/- 2%
- Память - показания 50 последних измерений
- Разрешение дисплея: 0.1
- Диапазон измерения
- Режим отображения: текущие и пиковые значения
- Питание - одна литиевая батарея CR2032 (3 В)

Ref.	Zakres/Range/Диапазон [Nm]	Kwadrat/Square/Квадрат	📦	📦	EAN
08-810	27-135	3/8"	12	48	5907558413014
08-811	40-200	1/2"	12	48	5907558413021



1/2"

### Kątomierz do dokręcania śrub

Torque angle gauge / Winkelmesser zum schraubenanziehen / Угломер для затяжки болтов / Кутомір для догайнювання гвинтів / Szögmérő csavar meghúzáshoz / Raportor la strângerea șuruburilor / Úhloměr k utahování šroubů / Uhlomer krútiaceho momentu / Kotomer za prívijanje vijakov / Varžič užpraidimo kampo matuoklis / Leņķmērs skrūvju pievilkšanai / Nurgamõõdik poltide pingutamiseks / Ёломер за динамометричен џлоч / Kutomjer za zatezanje vijaka / Uglomer za zavrtanje šrafova / Γωνιόμετρο σύφιξης βιδιών / Escuadra para atornillar tornillos / Goniometro per avvitare le viti / Transferidor para aparafusar / Clé de serrage angulaire / Gradenboog voor schroeven

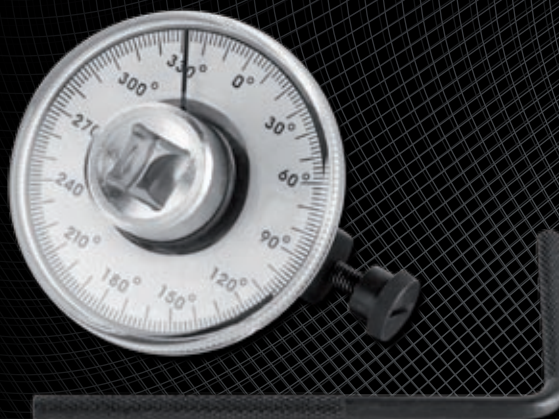

- Przydatny przy dokręcaniu śrub o daną wartość kąta zgodnie z zaleceniami technicznymi urzędzeń
- Podziałka posiada skalę co 2°
- Dzięki blokadzie istnieje możliwość pamięci kąta
- Obrotowa podziałka z tzw. „zerem”/początkiem pomiaru

- Useful for bolt tightening by a given angle value according to a device specification
- Scale with 2° graduation
- Lock for angle memorization
- Rotary scale with the so called „zero”/ measurement start

- Предназначен для измерения угла доворота крепежных деталей в соответствии с требованиями
- Цена деления 2°
- Благодаря блокировке помнит угол
- Поворотная шкала с так называемым „нулем”/ началом измерения

Ref.	Zakres/Range/Диапазон [°]	Kwadrat/Square/Квадрат	📦	📦	EAN
08-830	360°	1/2"	12	48	5907558416770



## Klucz płasko-oczkowy

Combination spanner / Maul-Ringschlüssel / Ключ комбинированный / Ключ комбінований, ріжково-накидний / Csillag-villáskulcs / Cheie combinată / Ključ očko-plochy / Ključ očko plochy / Kľuč viličasto-obročni / Raktas plokščias - kilpinis / Kombinētā atslēga / Universaalne mutrivāti / Ключ Звездозаочен / Kľuč kombinirani / Kľuč kombinovani / Γερανπολύκωνα / Llave combinada / Chiave piana chiusa / Chave plana-de luneta / Clef à fourche-polygonale / Moersleutel

DIN 3113



CrV steel

25 years guarantee

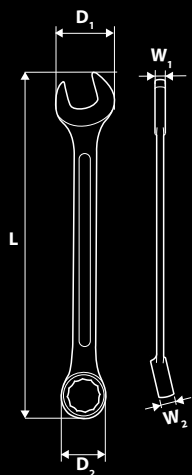

Ref.	⊘ [mm]	L [mm]	D <sub>1</sub> [mm]	W <sub>1</sub> [mm]	D <sub>2</sub> [mm]	W <sub>2</sub> [mm]	☞	☝	EAN
09-706	6	100	16	4	10	5	10	200	5907558410914
09-707	7	110	18	4	11	6	10	200	5907558410921
09-708	8	120	20	4	13	6	10	200	5907558410938
09-709	9	130	22	4	14	7	10	200	5907558410945
09-710	10	140	24	5	16	7	10	200	5907558410952
09-711	11	150	26	5	17	7	10	200	5907558410969
09-712	12	160	28	5	19	8	10	200	5907558410976
09-713	13	170	29	5	20	8	10	200	5907558410983
09-714	14	180	32	6	22	9	10	100	5907558410990
09-715	15	190	34	6	23	9	10	100	5907558411003
09-716	16	200	36	6	24	10	10	100	5907558411010
09-717	17	210	39	7	26	10	10	100	5907558411027
09-718	18	220	40	7	27	11	10	100	5907558411034
09-719	19	230	42	7	29	11	10	100	5907558411041
09-720	20	240	43	8	30	12	5	100	5907558411058
09-721	21	250	46	8	31	12	5	100	5907558411065
09-722	22	260	49	8	34	13	5	50	5907558411072
09-723	23	260	49	8	35	14	5	50	5907558411089
09-724	24	280	51	9	36	14	5	50	5907558411096
09-725	25	295	53	9	38	14	5	50	5907558411102
09-726	26	295	53	9	38	14	5	50	5907558411119
09-727	27	310	56	9	40	15	5	50	5907558411126
09-728	28	310	56	9	40	15	5	50	5907558411133
09-729	29	340	61	11	44	17	4	40	5907558411140
09-730	30	340	61	11	44	17	4	40	5907558411157
09-732	32	360	65	11	47	18	4	40	5907558411164
09-734	34	380	67	12	51	18	4	40	5907558411171
09-736	36	410	73	13	53	18	5	10	5907558412611
09-738	38	430	76	14	56	19	5	10	5907558412628
09-741	41	460	83	15	61	20	2	10	5907558412635
09-746	46	500	91	16	66	21	2	10	5907558412642
09-747	50	540	101	17	73	22	2	10	5907558412659
09-748	55	560	118	21	86	28	1	4	5907558412666
09-749	60	600	126	23	93	30	1	2	5907558412673

## Klucze płasko-oczkowe

Combination spanners / Ringschlüssel / Ключи комбинированные / Ключи комбіновані, ріжково-накидні / Csillag/villáskulcs / Set cheie fixe - inelare / Očkoploché kľúče / Kľúče ploché-očkové / Ploščato-obročni kľučji / Raktai plokščai, kilpiniai / Kombinētās atslēgas / Leht-silmusvõtmed / Комбинирані ключове / Plosnato okasti kľučevi / Pļosnato.okasti kľučevi / Κλειδιά γερανπολύκωνα / Llaves combinadas / Chiavi piane chiuse / Chaves plana-de luneta / Clefs à fourche-polygonales / Moersleutels

DIN 3113



CrV steel

25 years guarantee



Ref.	⊘ [mm]	☞	☝	EAN
09-750	6, 8, 10, 13, 15, 17 mm	0	25	5907558411515
09-751	6, 8, 10, 12, 13, 14, 17, 19 mm	0	25	5907558411522
09-752	6, 7, 8, 10, 11, 12, 13, 14, 15, 17, 19, 22 mm	0	20	5907558411539
09-753	8, 9, 10, 11, 12, 13, 14, 15, 16, 17, 18, 19, 22, 24, 27, 30, 32 mm	0	6	5907558413106
09-754	6, 7, 8, 9, 10, 11, 12, 13, 14, 15, 16, 17, 18, 19, 20, 21, 22, 23, 24, 25, 26, 27, 28, 29, 30, 32 mm	0	4	5907558413113

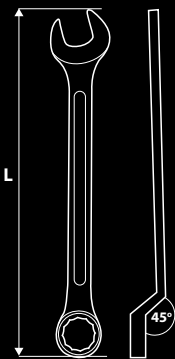

### Klucz płasko-oczkowy odgięty

Offset combination spanner / Ringschlüssel, flach, gebogen / Ключ комбинированный изогнутый / Ключ рижково-накидний, вигнутий / Enyhén hajlított csillag-villáskulcs / Cheie fixă – inelară curbată / Klíč očkoplochy vyhnutý / Plochy-očkový klíč ohnutý / Ploščati-obročni upognjeni ključ / Ploščias kilpinis raktas, lenktas / Izliekta plakana-uzmetamā atslēga / Kõvera otsaga leht-silmusvõti / Комбиниран отъгнат ключ / Plosnato okasti odvinuti ključ / Plijsnato-okasti obrnuti ključ / Клейді γερμανοπαλύγωνο κύρτο / Llave combinada acodada / Chiave combinata curva / Chave chave plana articulada curvada / Clef à fourche-polygonale contre-coudée / Gebogen moersleutel



- dwunastokątny kształt oczka
- 12 point ring
- dwunastokątna forma pierścienia
- kąt odgięcia 45 stopni
- 45 degrees offset
- угол изгиба 45 градусов

Ref.	⊘ [mm]	L [mm]	[ „ ]	[STAR]	📦	EAN
09-100	10	150	3/8	E12	120	5907558410198
09-102	12	170	15/32		120	5907558410204
09-103	13	180	1/2	E16	120	5907558410211
09-105	15	200	19/32		120	5907558410228
09-107	17	220	21/32		120	5907558410235
09-109	19	245	3/4	E24	60	5907558410242
09-111	22	275	7/8	E28	60	5907558410259
09-112	24	290	15/16	E30	40	5907558410266

### Klucze płasko-oczkowe

Combination spanners / Ringschlüssel / Ключи комбинированные / Ключі комбіновані, рижково-накидні / Csillag/villáskulcs / Set cheie fixe – inelare / Očkoploché klíče / Klúče ploché-očkové / Ploščato-obročni ključji / Raktai ploščti, kilpiniai / Kombinētas atslēgas / Leht-silmusvõtmed / Комбинираны ключове / Plosnato okasti ključēvi / Plijsnato.okasti ključēvi / Κλειδιά γερμανοπαλύγωνα / Llaves combinadas / Chiavi piane chiuse / Chaves plana-de luneta / Clefs à fourche-polygonales / Moersleutels



MM	6	8	10	11	12	13	14	15	16	17	18	19	20	21	22	24	27	30	32
INCH		5/16	3/8	7/16	15/32	1/2		19/32	5/8			3/4	25/32	13/16	7/8	15/16	1.1/16	1.1/8	1.1/4
STAR	E8	E10	E12	E14	E16		E18		E20		E22	E24							

- sferyczny, dwunastokątny kształt pasujący do śrub Torx, Spline, sześciokątnych, calowych i kwadratowych
- sferical, bi-hexagonal shape that fits to Torx, Spline, hexagonal, imperial and Robertson screws
- сферическая, двенадцатигранная форма для болтов Torx, Spline, шестигранных, дюймовых и квадратных
- antypoślizgowe wykończenie korpusu klucza
- anti-slip finishing of the spanner body
- антискользкий корпус ключа

Ref.	⊘ [mm]	m [kg]	📦	📦	EAN	
09-034	6, 7, 8, 9, 10, 11, 12, 13, 14, 15, 16, 17, 18, 19, 20, 21, 22, 23, 24 mm	x19	2,1	0	8	5907558411621
09-035	6, 7, 8, 9, 10, 11, 12, 13, 14, 15, 16, 17, 18, 19, 20, 21, 22, 23, 24, 25, 26, 27, 28, 29, 30, 32 mm	x24	5,7	0	6	5907558406344

## Klucz płasko-oczkowy

Combination spanner / Maul-Ringschlüssel / Ключ комбинированный / Ключ комбинований, ріжково-накидний / Csillag-villáskulcs / Cheie combinată / Ključ očko plochy / Ključ očko plochy / Ključ viličasto-obročni / Raktas plokščias - kilpinis / Kombinētā atslēga / Universaalne mutrivõti / Ключ Звездозаечен / Ključ kombinirani / Ključ kombinovani / Γερανοπολύγωνο / Llave combinada / Chiave piana chiusa / Chave plana-de luneta / Clef à fourche-polygonale / Moersleutel



DIN  
3113



CrV  
steel

25  
years  
guarantee



Ref.	⊕ [mm]	L [mm]	📦	📦	EAN
09-760	8	90	10	400	5907558410198
09-761	9	93	10	400	5907558410204
09-762	10	96	10	400	5907558410211
09-763	11	98	10	200	5907558410228
09-764	12	102	10	200	5907558410235
09-765	13	109	10	200	5907558410242
09-766	14	113	10	200	5907558410259
09-767	15	118	10	120	5907558410266
09-768	16	123	10	120	5907558412765
09-769	17	129	10	120	5907558412772
09-770	18	131	10	120	5907558412789
09-771	19	134	10	120	5907558412796

## Klucze płasko-oczkowe

Combination spanners / Ringschlüssel / Ключи комбинированные / Ключи комбинований, ріжково-накидні / Csillag/villáskulcs / Set chei fixe - inelare / Očkoploché klíče / Ključ ploché-očkové / Ploščato-obročni ključ / Raktai plokšči, kilpiniai / Kombinētās atslēgas / Leht-silmusvõtmed / Комбинирани ключове / Plosnato okasti ključevi / Plosnato.okasti ključevi / Ключи γερανοπολύγωνο / Llaves combinadas / Chiavi piane chiuse / Chaves plana-de luneta / Clefs à fourche-polygonales / Moersleutels

x8

DIN  
3113



CrV  
steel

25  
years  
guarantee



Ref.	⊕ [mm]	📦	📦	EAN
09-791	8, 9, 10, 12, 13, 14, 17, 19 mm	0	5	5907558413090

## Klucz płasko-oczkowy z grzechotką

Combination spanner with ratchet / Maul-Ringschlüssel mit Ratsche / Ключ комбинированный с трещоткой / Ключ комбинований ріжково-накидний з трісноткою / Csillag-villás kulcs racsnis / Cheie combinată cu morişă / Očkoplochy klíč s řehačkou / Ratschový OP ključ / Ključ viličasto-obročni z raglo / Raktas plokščias - kilpinis su terkšle / Kombinētā atslēga ar reversu / Universaalne mutrivõti pörkrattaga / Ключ Звездозаечен / Ključ kombinirani / Ključ kombinovani / Γερανοπολύγωνο και καρράκι / Llave combinada con carraca / Chiave piatta chiusa a cricco / Chave plana-de luneta z catraca de furar / Clef à fourche-polygonale à cliquet / Moersleutel met ratel



CrV  
steel



- Rozmiary: 10, 13, 15, 17, 19 mm
- Wysoka wytrzymałość dzięki stali CrV
- Dzięki mechanizmowi z 72 zębami minimalny kąt pracy kluczem wynosi 5°
- Sizes: 10, 13, 15, 17, 19 mm
- High durability owing to CrV steel
- The minimum operation angle is 5° owing to 72-tooth mechanism
- Размеры: 10, 13, 15, 17, 19 mm
- Высокая прочность благодаря стали CrV
- Благодаря 72-зубчатой храповой муфте минимальный угол работы с ключом составляет 5°

Ref.	⊕ [mm]	📦	📦	EAN
09-064	10	20	200	5907558416954
09-065	13	15	150	5907558416961
09-066	15	10	100	5907558416978
09-067	17	1	100	5907558416985
09-068	19	8	80	5907558416992



### Klucz płasko-oczkowy z przegubem i grzechotką

Combination flexible gear wrench / Ringschlüssel mit Gelenk und Ratsche / Ключ комбинированный трехточечный шарнирный / Ключ рожково-накидной з шарниром і тріточковою / Racsnis csillag-villáskulcs flexibilis fejjel / Cheie fixă -inelară cu articulație și clichet / Dčkaplochy klíč bez přepínání + kloub / Klíč plochy-očkový s klbom a račťou / Ploščati obročni ključ z zglobom in ragljo / Ploščšias kilpinis raktas su lankstu ir terkšle / Kombināta šarnīra atslēga / Leht-silmusvõti ligendi ja kõristiga / Плосък шарнирен ключ тресчотка / Plosnato okasti ključ sa zglobom i nastavkom / Plosnato-okasti ključ sa zglobom i čegrtaljkom / Γερμανοπολύγωνο αρθρωτό κλειδί με κασάνα / Llave combinada articulada con carraca / Chiave combinata snodata a cricchetto / Chave plana de luneta com articulação e catraca de furar / Clef à fourche polygonale articulée et à cliquet / Vlakke ringsleutel met ratel



Ref.	⊘ [mm]	L [mm]	📦	📦	EAN
09-051	8	135	10	200	5907558403435
09-052	10	160	10	200	5907558403442
09-055	13	185	10	200	5907558403459
09-057	15	220	10	100	5907558403466
09-059	17	230	10	100	5907558403473
09-061	19	250	10	60	5907558403480

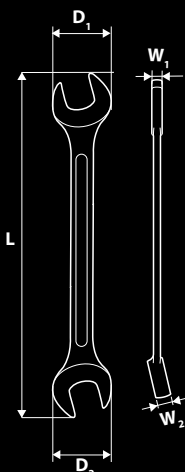

### Klucz płaski dwustronny

Double open end spanner / Doppelmaulschlüssel / Ключ рожково́й двусторонний / Ключ рожково́й двосторонний / Villáskulcs / Cheie piulă dublă cu cavitata deschisă / Klíč plochy oboustranný / Klíč vialcový / Viličasti ključ / Ploščšias dvipusis raktas / Ragatslēga divpusēja / Каhepoolne avatud otsaga võti / Ключ Гаечен / Ključ viljuškasti / Ključ viljuškasti / Диплò германικό κλειδί / Llave fija de dos bocas / Chiave piatta doppia / Chave plana de duas pontas / Clef à fourche double / Dubbelzijdige vlakke sleutel



Ref.		L [mm]	D <sub>1</sub> [mm]	W <sub>1</sub> [mm]	D <sub>2</sub> [mm]	W <sub>2</sub> [mm]	📦	📦	EAN
09-806	6x7	120	18	4	16	4	10	200	5907558411195
09-808	8x9	140	22	4	20	4	10	200	5907558411201
09-810	10x11	160	26	5	24	5	10	200	5907558411218
09-812	12x13	170	29	6	28	6	10	100	5907558411225
09-814	14x15	190	34	6	32	6	10	100	5907558411232
09-816	16x17	200	39	7	36	7	10	100	5907558411249
09-817	17x19	220	42	7	39	7	5	100	5907558411454
09-818	18x19	220	42	7	39	7	5	100	5907558411256
09-819	19x22	234	44	8	41	8	10	100	5907558411461
09-820	20x22	230	46	8	43	8	5	100	5907558411263
09-821	21x23	250	49	8	46	8	5	100	5907558411270
09-824	24x27	270	56	9	51	9	5	50	5907558411287
09-825	25x28	285	62	9	54	9	5	50	5907558411294
09-830	30x32	300	65	10	60	10	5	50	5907558411300

### Klucze płaskie dwustronne

Flat double sided wrenches / Mutterschlüssel, beidseitig / Ключи с открытым зевом двусторонние / Ключи рожково́й двобічні / Kétvégű villáskulcsok / Cheie fixă / Klíč ploché oboustranné / Klíče ploché obojstranní / Ploščšati obojestranski ključ / Ploščšti raktai, dvipusiai / Divpusēja plakana atslēga / Каhepoolsed lehtvõtmed / Плоски двосторонни ключове / Dvostrani plosnati ključevi / Dvočeljusni plosnati ključevi / Γερμανικό κλειδί δίπλο / Llaves fijas dobles / Chiavi piatte / Chaves planas de duas pontas / Clefs à fourches doubles / Vlakke tweezijdige sleutels

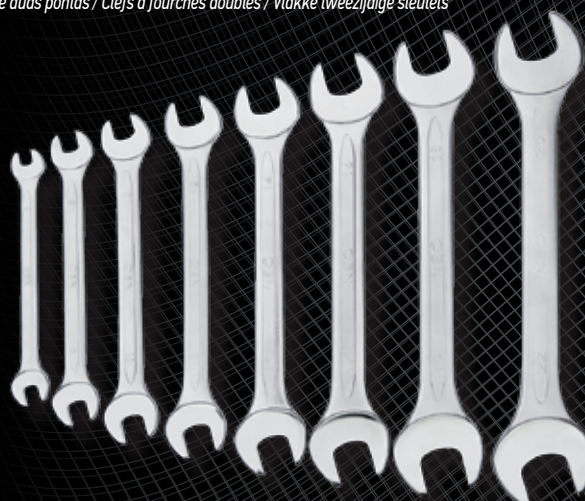

Ref.	⊘ [mm]	📦	📦	EAN
09-851	6x7,8x9,10x11,12x13,14x15,16x17,18x19,20x22 mm	0	20	5907558411546
09-852	6x7,8x9,10x11,12x13,14x15,16x17,18x19,20x22, 21x23, 24x27, 25x28, 30x32 mm	0	8	5907558413120

### Klucz oczkowy odgięty

Offset ring spanner / Ringschlüssel, gebogen / Ключ накидной изогнутый / Ключ накидный, изогнутый / Enyhén hajlított csillagkulcs / Cheie inelară-cotită / Ključ očkový vyhnutý / Očkový ključ ohnutý / Obročni upognjeni ključ / Kīlpinis raktas, lenktas / Izliekta uzstāvas atslēga / Kōvera otsaga silmusvāti / Глух заечен ключ отъгнат / Fleksibilni okasti ključ / Okasti ključ obrnuti / Ключи полуэвонного курта / Llave de estrella acodada / Chiave ad anello curva / Chave de luneta curvado / Clef polygonale contre-coudée / Gebogen ringsleutel

DIN 838



CrV steel

25 years guarantee



Ref.	⊘ [mm]	L [mm]	D <sub>1</sub> [mm]	W <sub>1</sub> [mm]	D <sub>2</sub> [mm]	W <sub>2</sub> [mm]	📦	📦	EAN
09-906	6x7	170	12	6	10	5	5	100	5907558411317
09-908	8x9	180	15	7	13	6	5	100	5907558411324
09-910	10x11	200	18	8	16	8	5	100	5907558411331
09-912	12x13	210	21	9	19	9	5	100	5907558411348
09-914	14x15	230	24	10	22	10	5	100	5907558411355
09-916	16x17	245	26	11	25	11	5	100	5907558411362
09-918	18x19	265	29	13	27	12	5	50	5907558411379
09-920	20x22	290	33	13	30	13	5	50	5907558411386
09-921	21x23	310	35	14	32	13	4	40	5907558411393
09-924	24x27	330	41	15	37	14	4	40	5907558411409
09-925	25x28	330	41	15	37	14	4	40	5907558411416
09-930	30x32	370	46	17	43	16	4	40	5907558411430

### Klucze oczkowe odgięte

Offset ring spanner set / Ringschlüssel gebogen / Ключи накидные колеччатые / Ключи накидные колеччатые, набор / Csillagkulcs készlet / Set chei inelare de deviatie / Očkový ključ vyhnutý / Súprava očkových ključov / Garnitura obročni ključev, upognjjenih / Kīlpinis, lenktu raktų komplektas / Kombinēto izliekto atslēgu komplekts / „Ofset” mutrivõitmete komplekt / Ключ Луна / Ključ okasti / Ključ okasti set / Συλλογή κυρτών πολυγωνων κλειδιών με κεκλιμένη κεφαλή / Llaves de estrella, acodadas / Chiavi piane chiuse / Chaves de luneta curvadas / Clefs polygonales contre-coudées / Gebogen ringsleutels

DIN 838



CrV steel

25 years guarantee



Ref.	⊘ [mm]	📦	📦	EAN
09-950	6x7, 8x9, 10x11, 12x13, 14x15, 16x17 mm	0	20	5907558411553
09-952	6x7, 8x9, 10x11, 12x13, 14x15, 16x17, 18x19, 20x22, 21x23, 24x27, 25x28, 30x32 mm	0	6	5907558413137

### Klucze oczkowe z grzechotką

Ring wrench with ratchet / Ringschlüssel mit Ratsche / Ключи накидные с трещоткой / Ключи накидные с трещоткою / Racsnis csillagkulcs / Cheie inelara cu clichet / Ključe račnové očkové přepínací / Ključe očkové s račťou / Obročni ključci z ragljo / Ploški raktai su terkšlėmis / Uzstāvas atslēgas / Kōristiga silmusvāti med / Глух заечни ключове с трещотка / Okasti ključevni s nastavkom / Okasti ključevni sa čerpaljkom / Πολυγωνο κλειδι με κασάνα / Llaves de estrella con carraca / Chiavi ad anello con cricchetto / Chaves de luneta z catraca de furar / Clefs polygonales à cliquet / Ringsleutels met ratel

x4



72

CrV steel

25 years guarantee



- mechanizm zapadkowy 72 zęby
- 72 teeth ratchet gear
- реверсивный механизм на 72 зуба
- zakres: 8x10, 12x13, 14x15, 17x19 mm
- range: 8x10, 12x13, 14x15, 17x19 mm
- диапазон: 8x10, 12x13, 14x15, 17x19 мм

Ref.	⊘ [mm]	📦	📦	EAN
09-070	8x10, 12x13, 14x15, 17x19 mm	6	24	5907558410181

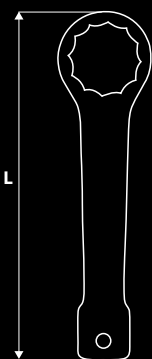

DIN  
7444

CrMo  
steel

25  
years  
guarantee

### Klucz oczkowy do pobijania

Slugging ring wrench / Ringschlüssel, zum Aufheben / Ключ накладной ударный / Ключ накладный, ударный / Ütő-csillagkulcs / Cheie inelară cu batator / Klíč úderový očkový / Sekáci očkový klúč / Obročni ključ za zabijanje / Raktas kilpinis, smūginis / Trieciēna atslēga / Löök-silmusvõti / Гаечен ключ ударен / Okasti ključ za nabijanje / Okasti ključ za zabijanje / Ключи полуглово кроушс / Llave de estrella de golpe / Chiave chiusa a maglietta / Chave de luneta para malhar / Clef polygonale à frapper / Slagringseutel



- odkuwany
- wzmacniona końcówka do pobijania młotem
- do montażu i demontażu ciężkich śrub i nakrętek
- forged
- reinforced tip for hammer-striking
- for assembly and disassembly of heavy nuts and bolts
- кованный
- нерабочая сторона усилена
- для монтажа и демонтажа тяжелых болтов и гаек

Ref.	⊘ [mm]	L [mm]	📦	📦	EAN
09-180	22	165	3	30	5907558412923
09-181	24	165	3	30	5907558404883
09-182	27	180	3	30	5907558404890
09-183	30	190	3	30	5907558404906
09-184	32	190	3	30	5907558404913
09-185	36	205	3	30	5907558404920
09-186	38	210	3	30	5907558404937
09-187	41	230	3	24	5907558404944
09-188	46	240	3	24	5907558404951
09-189	50	255	2	16	5907558404968
09-190	55	265	2	16	5907558404975
09-191	60	280	2	16	5907558404982
09-192	65	300	2	16	5907558404999



CrV  
steel

25  
years  
guarantee

### Klucz oczkowy półotwarty

Flare nut wrench / Ringschlüssel halboffen / Ключ разрезной двусторонний / Ключ торцевой нарезный двусторонний / Fékcsőkulcs / Cheie piulită în formă de con / Očkový klíč polootevřený / Klíč otvorený očkový / Obročni ključ, odprti / Kilpinis raktas / Bremžu trubiņu atslēga / Vargamutri võti / Ключ гаечен / Ključ ekscentrični / Ключ / Полуглово ключи гмáноухто / Llave de estrella, abierta / Chiave chiusa semiaperta / Chave de luneta semi aberta / Clef polygonale demi ouverte / Halfopen ringsleutel



- odkuwany, wzmacniony
- kąt odchylenia 15 stopni
- forged, reinforced
- offset angle 15 degrees
- кованный, усиленный
- угол наклона головки 15°

Ref.	⊘ [mm]	L [mm]	📦	📦	EAN
09-141	8x9	130	25	100	5907558404746
09-143	9x11	150	25	100	5907558404753
09-145	10x12	150	25	100	5907558404760
09-147	12x13	170	25	100	5907558404777
09-149	13x14	170	25	100	5907558404784
09-151	15x17	195	25	100	5907558404791
09-154	19x21	230	25	100	5907558404807



CrV  
steel

### Klucz oczkowy półotwarty

Flare nut wrench / Ringschlüssel halboffen / Ключ разрезной двусторонний / Ключ торцевой нарезный двусторонний / Fékcsőkulcs / Cheie piulită în formă de con / Očkový klíč polootevřený / Klíč otvorený očkový / Obročni ključ, odprti / Kilpinis raktas / Bremžu trubiņu atslēga / Vargamutri võti / Ключ гаечен / Ključ ekscentrični / Ключ / Полуглово ключи гмáноухто / Llave de estrella, abierta / Chiave chiusa semiaperta / Chave de luneta semi aberta / Clef polygonale demi ouverte / Halfopen ringsleutel



- Rozmiary: 10, 11, 12, 13, 14, 15, 17 mm
- Wysoka wytrzymałość dzięki stali CrV
- Wykorzystywane do odkręcania przewodów hydraulicznych, pneumatycznych, paliwowych
- Sizes 10, 11, 12, 13, 14, 15, 17 mm
- High durability owing to CrV steel
- Used for unscrewing hydraulic, pneumatic and fuel hoses
- Размеры: 10, 11, 12, 13, 14, 15, 17 mm
- Высокая прочность благодаря стали CrV
- Позволяет снимать гидравлические, топливные, тормозные трубки

Ref.	⊘ [mm]	📦	📦	EAN
09-244	10	24	288	5907558417005
09-245	11	24	216	5907558417012
09-246	12	24	216	5907558417029
09-247	13	12	120	5907558417036
09-248	14	12	120	5907558417043
09-249	15	12	120	5907558417050
09-250	17	12	96	5907558417067

## Klucz oczkowy wygięty

Offset ring spanner / Ringschlüssel, gebogen / Ключ накладной изогнутый / Ключ накладный, выгнутый / Csillagkulcs / Cheie inelară semilună / Očkový klíč zahnutý / Očkový klíč vyhnutý / Obročni ukrivljeni ključ / Kīrpinis raktas, lenktas / Izliekta uzmanas atslēga / Poalkuu-silmusvõti / Глук заечен ключ отъгнат / Okasti savinut ključ / Okasti izvijeni ključ / Ключи полукруго крпті / Llave de estrella de media luna / Chiave ad anello curva / Chave de luneta curvada / Clef polygonale coudée / Uitgebogen ringsleutel

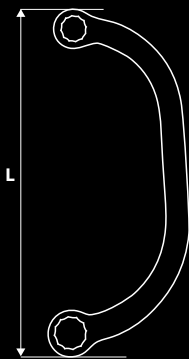

CrV  
steel

25  
years  
guarantee



- odkuwany, wzmocniony
- forged, reinforced
- кованный, усиленный
- chwyt łukowy, odporny na wygięcia
- arc handle, resistant to bending
- прочная дугообразная ручка

Ref.	Ø [mm]	L [mm]	⊞	⊞	EAN
09-161	8x10	140	12	240	5907558404814
09-163	10x12	145	12	240	5907558404821
09-164	11x13	165	12	240	5907558404838
09-167	13x15	190	12	180	5907558404845
09-169	14x17	255	12	180	5907558404852
09-175	19x22	345	12	60	5907558404869

## Klucze oczkowe Torx

Offset ring spanner set / Ringschlüssel / Ключи накладные колеччатые / Ключи накладні / Csillagkulcs készlet / Set chei inelare de deviatie / Klíče očkové / Súprava očkových klíčův / Obročni ključ / Kīrpiniai raktai / Kombinēto izliekto atslēgu komplekts / Mutrivõtmete komplekt / Ключ Луна компн. / Ključ okasti / Πολύγωνα Κλειδιά / Llaves de estrella / Chiavi chiuse / Chaves de luneta / Clefs polygonales / Ringsleutels

x4



CrV  
steel

25  
years  
guarantee



Ref.	⊞	⊞	EAN	
09-980	T6xT8, T10xT12, T14xT18, T20xT24	0	60	5907558412239

## Klucze oczkowe wygięte

Offset ring spanner / Ringschlüssel, gebogen / Ключ накладной изогнутый / Ключ накладный, выгнутый / Csillagkulcs / Cheie inelară semilună / Očkový klíč zahnutý / Očkový klíč vyhnutý / Obročni ukrivljeni ključ / Kīrpinis raktas, lenktas / Izliekta uzmanas atslēga / Poalkuu-silmusvõti / Глук заечен ключ отъгнат / Okasti savinut ključ / Okasti izvijeni ključ / Ключи полукруго крпті / Llave de estrella de media luna / Chiavi ad anello curve / Chaves de luneta curvadas / Clefs polygonales coudées / Uitgebogen ringsleutels

x5



CrV  
steel

25  
years  
guarantee

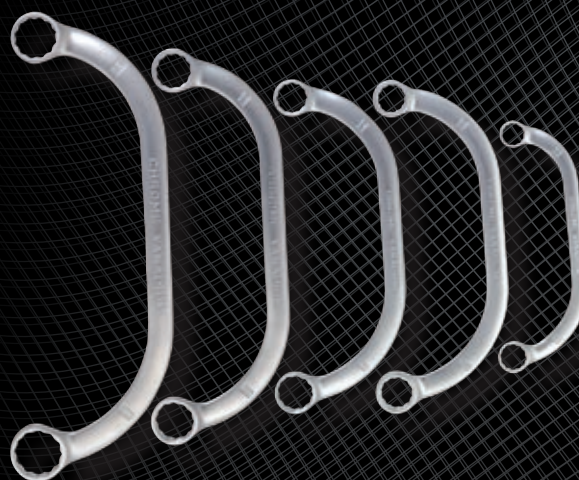

Ref.	Ø [mm]	m [kg]	⊞	⊞	EAN
09-176	9x12, 13x15, 14x17, 16x18, 19x22	1,0	0	10	5907558404876

### Klucze płasko-nasadowe przegubowe

Flexible socket and open wrenches / Gelenk-Steckschlüssel, flach / Ключи шарнирные комбинированные / Ключи комбіновані, ріжнорізно-торцеві, шарнірні / Flexibilis villás-dugókulcsok / Chei fixe - tubulare cu articulație / Ploché a nástrčné klúče kloubové / Ploché-nástrčné klúče klbové / Ploščato-nasadni ključ z zglobom / Ploščti antgaliai veržlerakčiui su lankstu / Šarnīra plakana-uzmavas atslēga / Liigendiga lehtpadrunvõtmed / Комбиниран шарнирен ключ / Plosnato nasadni zglobni ključevi / Zglobni pljosnato-okasti ključevi / Ключи ґерманоналуґуво арθρωτά / Llaves combinadas (fijas y de vaso) articuladas / Chiavi a forchetta e a bussola snodate / Chaves articuladas planas / Clefs à fourche à douilles articulées / Vlakke geopend dopsleutels

x6



CrV  
steel

25  
years  
guarantee



- zakres ruchu główki 220 stopni - head angle range: 220 degrees - угол наклона головки 220°

Ref.	[mm]	m[kg]	☞	☞	EAN
09-115	10, 12, 13, 15, 17, 19	1,15	0	12	5907558404647



### Klucze Torx przegubowe

Flex Torx wrench / Torx-Gelenkschlüssel / Ключи шарнирные для внутреннего Torx / Ключи «Торх» шарнірні / Flexibilis Torx kulcsok / Chei duble Torx cu articulație / Klúče Torx kloubové / Klúče Torx klbové / Ključ Torx z zglobom / Torciniai raktai su lankstais / Šarnīra atslēga iekšējā Torx / Liigendiga Torx-võtmed / Ключове Торх шарнірні / Ključ Torx zglobni / Zglobni Torx ključevi / Ключи арθρωτά για εσωτερικό Torx / Llaves torx articuladas / Chiavi Torx a bussola snodate / Chaves Torx articuladas / Clefs Torx articulées / Geopend Torx sleutels

x5



CrV  
steel

25  
years  
guarantee



- zakres ruchu główki 220 stopni - head angle range: 220 degrees - угол наклона головки 220°

Ref.	[mm]	☞	☞	EAN
09-116	T15, T20, T25, T27, T30, T40, T45, T50, T55, T60	0	12	5907558405422



### Klucze Torx przegubowe nasadowe

Flex socket Torx wrenches / Torx-Gelenksteckschlüssel / Ключи шарнирные для внешнего Torx / Ключи «Торх» шарнірні, торцеві / Flexibilis Torx-dugókulcsok / Chei duble tubulare cu articulație / Klúče Torx kloubové nástrčné / Klúče Torx klbové nástrčné / Nasadni ključ Torx z zglobom / Torciniai raktai su lankstiomis galvutėmis / Šarnīra atslēga ārējā Torx / Liigendiga Torx-padrundvõtmed / Шарнирни ґаечни ключове Торх / Ključ Torx zglobni nasadni / Zglobni Torx natikač ključevi / Ключи арθρωτά για εξωτερικό Torx / Vasos torx articuladas / Chiavi Torx a bussola snodate / Chaves Torx articuladas tubulares / Clefs Torx articulées à douilles / Geopend Torx dopsleutels

x5



CrV  
steel

25  
years  
guarantee



- zakres ruchu główki 220 stopni - head angle range: 220 degrees - угол наклона головки 220°

Ref.	[mm]	m[kg]	☞	☞	EAN
09-117	E6, E8, E10, E12, E14, E16, E18, E20, E22, E24	1,15	0	12	5907558405439





## Klucze dwunastokątne przegubowe nasadowe

Flex bi-hex socket wrench / Zwölfkant-Gelenksteckschlüssel / Ключ шарнирный для внутреннего двенадцатигранника / Ключ двенадцатигранный, торцевой, шарнирный / 12-lapú Flexibilis dugökules / Cheie tubulară cu articulație / Ključ dvanaćihranny kloubový nástrčný / Dvanaćihranny nástrčný ključ klbový / Nasadni dvanaćkotni ključ z zglobom / Dvylíkkampis raktas su lankšča galvute / Divpadsmitškaitņi šamīra atslēga / Liigendiga kaksteistkant-padrūnvāti / Дванадесетъгълен шарнирен ключ / Dvanaestokutni nasadni zglobni ključ / Dvanaestougāoni zglobni ključ natīkač / Ключи арθρωτά για εσωτερικό δωδεκάγωνο / Vaso destornillador de encaje dodecagonal articulada / Chiavi poligonali a bussola snodate / Chaves de doze ângulos articuladas tubulares / Clefs à 12 pans articulées à douilles / Twaalfkant dopsleutels



- zakres ruchu główki 220 stopni - head angle range: 220 degrees - угол наклона головки 220°

Ref.	⊕ [mm]	L [mm]	📦	📦	EAN
09-121	6x7	185	25	100	5907558404654
09-122	8x9	185	25	100	5907558404661
09-124	10x11	200	25	100	5907558404678
09-126	12x13	215	25	100	5907558404685
09-128	14x15	240	25	50	5907558404692
09-131	16x17	260	25	50	5907558405781
09-132	17x19	260	25	50	5907558404708
09-133	18x19	270	25	50	5907558405798
09-134	20x22	305	12	24	5907558404715
09-135	21x23	305	12	24	5907558405804
09-137	24x27	330	6	24	5907558404722
09-138	30x32	345	6	12	5907558406764



## Klucze dwunastokątne przegubowe nasadowe

Flex bi-hex socket wrench / Zwölfkant-Gelenksteckschlüssel / Ключ шарнирный для внутреннего двенадцатигранника / Ключ двенадцатигранный, торцевой, шарнирный / 12-lapú Flexibilis dugökules / Cheie tubulară cu articulație / Ključ dvanaćihranny kloubový nástrčný / Dvanaćihranny nástrčný ključ klbový / Nasadni dvanaćkotni ključ z zglobom / Dvylíkkampis raktas su lankšča galvute / Divpadsmitškaitņi šamīra atslēga / Liigendiga kaksteistkant-padrūnvāti / Дванадесетъгълен шарнирен ключ / Dvanaestokutni nasadni zglobni ključ / Dvanaestougāoni zglobni ključ natīkač / Ключи арθρωτά για εσωτερικό δωδεκάγωνο / Vaso destornillador de encaje dodecagonal articulada / Chiavi poligonali a bussola snodate / Chaves de doze ângulos articuladas tubulares / Clefs à 12 pans articulées à douilles / Twaalfkant dopsleutels



- zakres ruchu główki 220 stopni - head angle range: 220 degrees - угол наклона головки 220°

Ref.	⊕ [mm]	m[kg]	📦	📦	EAN
09-140	8x9, 10x11, 12x13, 14x15, 16x17, 18x19	1,45	0	12	5907558404739



## Klucz fajkowy

L-type wrench / Pfeifenschlüssel / Рожковый ключ / Ключ торцовый изогнутый / Pipakules / Cheie tubulară cotită / Zahnfuß ključ / Fajkový ključ / Uragnjen ključ / Рупкин рактас / Radziņatslēga / Padrūnvāti / Ключ лупа / Imbus ključ / Kosčeljusni zavrtnjani ključ / Терпаніко ключі / Llave de pipa / Chiave a pipa / Chave de cabo curvo / Clef à pipe / Pijpsleutel



Ref.	⊕ [mm]	L [mm]	D [mm]	D <sub>1</sub> [mm]	📦	📦	EAN
09-203	8	110	13,2	13,2	10	200	5907558405002
09-205	10	130	16	16	10	120	5907558405019
09-207	12	140	18	18	10	100	5907558405026
09-208	13	150	19,2	19,2	10	100	5907558405033
09-209	14	160	21	21	10	80	5907558405040
09-210	15	170	22,3	22,3	10	80	5907558405057
09-212	17	180	25	25	10	60	5907558405064
09-214	19	200	28	28	10	40	5907558405071
09-217	22	230	32	32	10	30	5907558405088
09-219	24	250	34,5	34,5	10	20	5907558405095
09-223	27	260	37,4	37,4	5	15	5907558405101
09-226	30	300	42,3	42,3	5	10	5907558405118
09-227	32	320	44	44	5	10	5907558405125





CrV  
steel

### Klucz trzpieniowy nasadowy

T-socket wrench / Vierkant-Aufsteckschlüssel / Ключ торцевой T-образный / Ключ шестигранный торцевой накидной / T-kulcs / cheie fixare forma T / Nástrčkový kľúč typu T / T kľuč / T kľuč nasadni / T formos raktas / T-veida gala atslēga / T-padrūni mutrīvdi / T-образен ключ / T Kľuč / T kľuč / Катавдбака карыбака тыпу T / Llave de vaso con mango en T / Chiave a tubo con stelo / Chave tubular / Clef mâle à douilles articulée / Imbusdöpsleutel

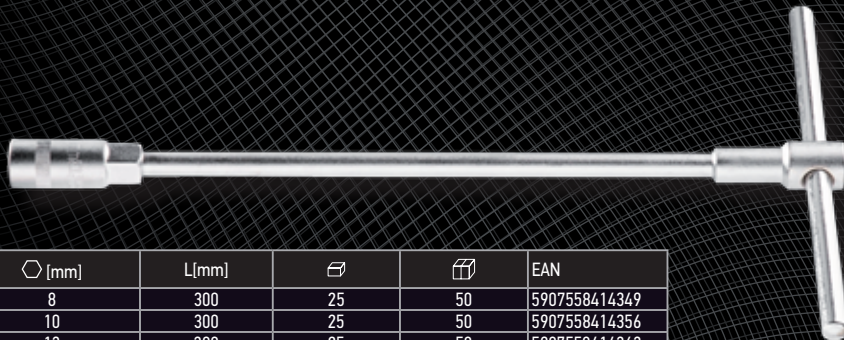

Ref.	⊘ [mm]	L [mm]	📦	📦	EAN
09-300	8	300	25	50	5907558414349
09-301	10	300	25	50	5907558414356
09-302	13	300	25	50	5907558414363
09-303	15	300	25	50	5907558414370
09-304	17	300	25	50	5907558414387

### Wkrętaki do śrub

Screw extractor set / Schraubendreher / Экстракторы для винтов / Викручувачі зламаних завинтів / Törtsavar-kihajtó készlet / Set înlăturare șuruburi / Vytahováč šroubů / Súprava vyťahovačov zalomených skrutiek / Garnitura odvijáčev vijakov / Atsuktuvai varžtams / Skrūvju izvilcējs / Krūviemalduskomplekt / Izvijac polomljenih vijaka / Συλλογή μηχανημάτων αφαίρεσης βιδών / Extractores de tornillos / Svitabulloni / Saca-parafusos / Deviseuses pour vis / Schroevenlosdraaiers

x6

3/8"

CrMo  
steel

25  
years  
guarantee



- 6 wkrętaków 3/8", długość 60 mm
- 2 mm do śrub M5
- 3 mm do śrub M6
- 4 mm do śrub M8
- 6 mm do śrub M10-12
- 8 mm do śrub M14-16
- 10 mm do śrub M18-20
- 6 screw extractors 3/8", length 60 mm
- 2 mm for M5 screws
- 3 mm for M6 screws
- 4 mm for M8 screws
- 6 mm for M10-12 screws
- 8 mm for M14-16 screws
- 10 mm for M18-20 screws
- 6 высверливателей 3/8", длина 60 мм
- 2 мм для винтов M5
- 3 мм для винтов M6
- 4 мм для винтов M8
- 6 мм для винтов M10-12
- 8 мм для винтов M14-16
- 10 мм для винтов M18-20

Ref.	Ra [mm]	L [mm]	📦	📦	EAN
09-605	2-10	60	0	50	5907558410341



x5

1/2"

CrMo  
steel

### Wkrętaki do śrub

Screw extractor set / Schraubendreher / Экстракторы для винтов / Викручувачі зламаних завинтів / Törtsavar-kihajtó készlet / Set înlăturare șuruburi / Vytahováč šroubů / Súprava vyťahovačov zalomených skrutiek / Garnitura odvijáčev vijakov / Atsuktuvai varžtams / Skrūvju izvilcējs / Krūviemalduskomplekt / Izvijac polomljenih vijaka / Συλλογή μηχανημάτων αφαίρεσης βιδών / Extractores de tornillos / Svitabulloni / Saca-parafusos / Deviseuses pour vis / Schroevenlosdraaiers

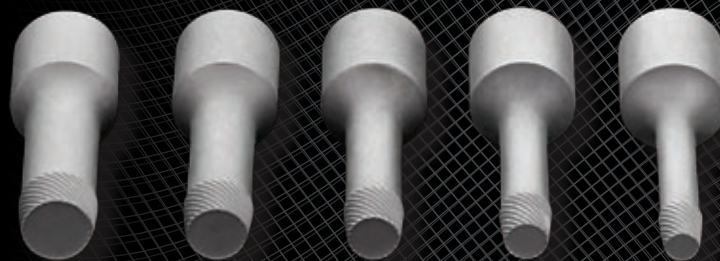

- Rozmiary: 8, 10, 12, 14, 16 mm
- Sizes: 8, 10, 12, 14, 16 mm
- Размеры: 8, 10, 12, 14, 16 мм

Ref.	Ra [mm]	📦	📦	EAN
09-606	8-16	1	20	5907558416558

**NEW****x15****1/2"****CrMo  
steel****Wykrętaki do śrub**

Screw extractor set / Schraubendreher / Экстракторы для винтов / Виртууучачи эламаних эвинтис / Törtsavar-kihajtó készlet / Set înlăturare șuruburi / Vytahováč šroubů / Súprava vytahovačov zalomených skrutiek / Garnitura odvíjačov vijakov / Atsuktuvai varžtams / Skrūvju izvilcējs / Krūvieemalduskomplekt / Izvijac polomljenih vijaka / Συλλογή μηχανημάτων αφαίρεσης βιδών / Extractores de tornillos / Svitabulloni / Saca-parafusos / Deviseuses pour vis / Schroevenlosdraaiers



Ref.	Ra[mm]	Ra["]	📦	📦	EAN
09-607	3 - 10	1/8 - 3/8	1	20	5907558417241

**NEW****x4****1/2"****CrV  
steel****Komplet ściągaczy do szpilek**

Roller stud extractor set / Abszieher-set / Набор ключей для снятия штифтов / Комплект выкруток до шпильок / Törtsavar kihajtó készlet / Set complet de extractoare pentru / Sada stahovadel na závrtné šrouby / Súprava valčekových stahovákov skrutiek / Komplet snemalcev zatičev / Nušmēju rinkinys smeigėms / Novilcēju komplekts tapskrūvēm / Vardatōmmisate komplekt / Комплект экстрактора за шпильки / Set skidača za nasadne ključeve / Komplet stega za igle / Σετ κλειδιά αφαίρεσης πειρών / Juego de extractores para agujas / Set estrattori per spilli / Kit de sacadores de pregas / Jeu d'extracteurs de goujon / Set van trekkers voor naalden

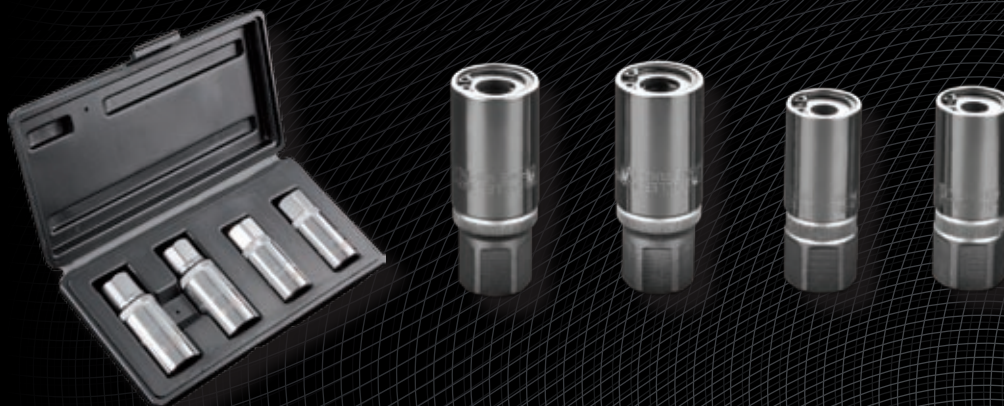

- Rozmiary: 6, 8, 10, 12 mm

- Sizes: 6, 8, 10, 12 mm

- Размеры: 6, 8, 10, 12 мм

Ref.	Ra[mm]	📦	📦	EAN
09-608	6 - 12	1	24	5907558416534

**NEW****x10****CrMo  
steel****Wykrętaki do śrub**

Screw extractor set / Schraubendreher / Экстракторы для винтов / Виртууучачи эламаних эвинтис / Törtsavar-kihajtó készlet / Set înlăturare șuruburi / Vytahováč šroubů / Súprava vytahovačov zalomených skrutiek / Garnitura odvíjačov vijakov / Atsuktuvai varžtams / Skrūvju izvilcējs / Krūvieemalduskomplekt / Izvijac polomljenih vijaka / Συλλογή μηχανημάτων αφαίρεσης βιδών / Extractores de tornillos / Svitabulloni / Saca-parafusos / Deviseuses pour vis / Schroevenlosdraaiers



- Rozmiary: 2, 3, 4, 6.5, 7.5 mm

- Sizes: 2, 3, 4, 6.5, 7.5 mm

- Размеры: 2, 3, 4, 6.5, 7.5 мм

Ref.	Ra[mm]	📦	📦	EAN
09-609	2 - 7.5	1	60	5907558416503





x5

CrMo  
steel

### Wkrętki do śrub

Screw extractor set / Schraubendreher / Экстракторы для винтов / Викручувачі зламаних винтів / Törtsavar-kihajtó készlet / Set înlăturare șuruburi / Vytahováč šroubů / Súprava vytáhačov zalomených skrutiek / Garnitura odvíjačov vijakov / Afskruiverijzets / Skrūvju izvilcējs / Krūvieemalduskomplekt / Izvijac polomljenih vijaka / Συλλογή μηχανημάτων αφαίρεσης βιδιών / Extractores de tornillos / Svitabulloni / Saca-parafusos / Deviseuses pour vis / Schroevenlosdraaiers



1/8" (M3-M6), 1/4" (M6-M8), 5/16" (M8-M11), 7/16" (M11-M14), 9/16" (M14-M18)

Ref.	Ra[M]	⊖	⊞	EAN
09-615	3 - 18	25	150	5907558416497



### Wkrętek płaski

Screwdriver slotted / Flachsraubendreher / Отвертка плоская / Відкрітка плоска / Csavarhúzó / Šurubelnitá platá / Šroubovák plochý / Skrutkovač plochý / Ploščati izvijač / Ploščias afskruiveris / Skrūvgriezis plakans / Ламперо-кривикероја / Отвертка / Одвijač / Одвijač / Καταβίδι εγκοπής / Destornillador plano / Cacciavite piatto / Chave de fenda plana / Tournevis à fourche / Vlakke schroevendraaier

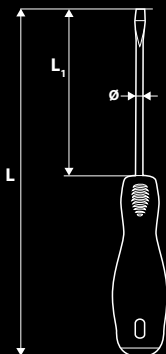

SVCM  
steel

25  
years  
guarantee



Ref.	⊖ [mm]	L [mm]	L <sub>1</sub> [mm]	ø [mm]	⊖	⊞	EAN
04-011	3,0	150	75	3,0	12	600	5907558401745
04-012	4,0	180	100	4,0	12	240	5907558401752
04-013	5,5	205	100	5,0	12	240	5907558401769
04-014	5,5	310	200	5,0	12	144	5907558401776
04-001	6,5	100	38	6,0	12	288	5907558411638
04-002	6,5	240	125	6,0	12	144	5907558411645
04-015	6,5	270	150	6,0	12	144	5907558401783
04-003	8,0	275	150	8,0	12	120	5907558411652
04-016	8,0	325	200	8,0	12	120	5907558401790
04-004	10,0	325	200	9,5	6	96	5907558411669

### Wkrętek płaski równoległy

Screwdriver slotted / Flachsraubendreher / Отвертка плоская / Відкрітка плоска / Csavarhúzó / Šurubelnitá platá / Šroubovák plochý / Skrutkovač plochý / Ploščati izvijač / Ploščias afskruiveris / Skrūvgriezis plakans / Ламперо-кривикероја / Отвертка / Одвijač / Одвijač / Καταβίδι εγκοπής / Destornillador plano / Cacciavite piatto / Chave de fenda plana / Tournevis à fourche / Vlakke schroevendraaier

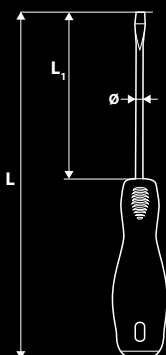

SVCM  
steel

25  
years  
guarantee



Ref.	⊖ [mm]	L [mm]	L <sub>1</sub> [mm]	ø [mm]	⊖	⊞	EAN
04-011	3,0	150	75	3,0	12	600	5907558401745
04-101	3,0	180	100	3,0	12	480	5907558413410
04-012	4,0	180	100	4,0	12	240	5907558401752
04-103	5,5	205	100	5,5	12	240	5907558413434
04-104	5,5	270	150	5,5	12	240	5907558413441
04-105	5,5	325	200	5,5	12	144	5907558413458
04-106	5,5	375	250	5,5	12	180	5907558413465
04-107	5,5	420	300	5,5	12	144	5907558413472
04-108	6,5	220	100	6,5	12	144	5907558413489
04-109	6,5	300	180	6,5	12	144	5907558413496
04-110	6,5	320	200	6,5	12	180	5907558413502
04-111	6,5	420	300	6,5	12	144	5907558413519

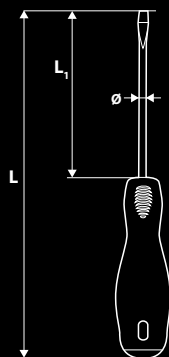

### Wkręćak krzyżowy PH

Screwdriver Phillips / Kreuzschraubendreher / Отвертка крестовая / Відкрітка хрестовидна / Csavarhúzó phillips / Şurubelniță tip „Phillips” / Šroubovák křížový / Skrutkovač PH / Križni izvijač / Kryžminis atsuktuvus Phillips / Skrūvgriežis krusta PH / Ristpeakruvikeeraja / Отвертка / Одвијач / Одвијач / Καταβίθι σταυρωτά τύπου phillips / Destornillador phillips / Cacciavite crociforme / Chave de fenda de cruzeta / Tournevis en croix / Kriusschroevendraaier



Ref.	⊕	L[mm]	L <sub>1</sub> [mm]	ø[mm]	📦	📦	EAN
04-021	PH0	150	75	3	12	600	5907558401806
04-006	PH1	180	75	5	12	240	5907558411683
04-022	PH1	205	100	5	12	240	5907558401813
04-023	PH2	100	38	6	12	288	5907558401820
04-024	PH2	220	100	6	12	144	5907558401837
04-007	PH2	265	150	6	12	120	5907558411713
04-025	PH2	315	200	6	12	144	5907558401844
04-026	PH3	275	150	8	12	120	5907558401851

### Wkręćak krzyżowy PZ

Screwdriver Pozidriv / Kreuzschraubendreher / Отвертка крестовая / Відкрітка хрестовидна / Csavarhúzó pozidriv / Şurubelniță tip „Pozidriv” / Šroubovák křížový / Skrutkovač PZ / Križni izvijač / Kryžminis atsuktuvus Phillips / Skrūvgriežis krusta PZ / Ristpeakruvikeeraja Pozidriv / Отвертка / Одвијач / Одвијач / Καταβίθι τύπου pozidriv / Destornillador phillips / Cacciavite crociforme / Chave de fenda de cruzeta / Tournevis en croix / Kriusschroevendraaier

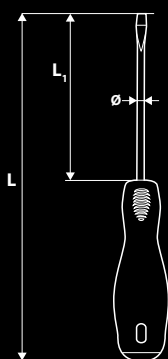

Ref.	⊕	L[mm]	L <sub>1</sub> [mm]	ø[mm]	📦	📦	EAN
04-031	PZ0	150	75	3	12	600	5907558401868
04-032	PZ1	200	100	5	12	240	5907558401875
04-033	PZ2	100	38	6	12	288	5907558401882
04-034	PZ2	215	100	6	12	144	5907558401899
04-035	PZ2	320	200	6	12	144	5907558401905
04-036	PZ3	280	150	8	12	120	5907558401912

### Wkręćak Torx

Torx screwdriver / Schraubendreher Torx / Отвертка Torx / Відкрітка «Торх» / Torx csavarhúzó / Surubelniță varf Torx / Šroubovák Torx / Skrutkovač Torx / Izvijač Torx / Atsuktuvus, torcinis / Torx skrūvgriežis / Torx-kruvikeeraja / Отвертка Torx / Одвијач Torx / Одвијач Torx / Καταβίθι Torx / Destornillador con punta torx / Cacciavite Torx / Chave de fenda Torx / Tournevis Torx / Torx schroevendraaier

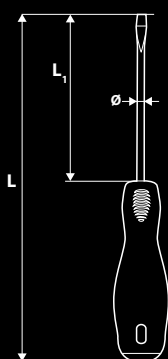

Ref.	⊕	L[mm]	L <sub>1</sub> [mm]	ø[mm]	📦	📦	EAN
04-043	T10	205	100	5	12	240	5907558401929
04-044	T15	205	100	5	12	240	5907558401936
04-045	T20	205	100	5	12	240	5907558401943
04-046	T25	215	100	6	12	144	5907558401950
04-047	T27	215	100	6	12	144	5907558401967
04-048	T30	215	100	6	12	144	5907558401974
04-049	T40	215	100	7	12	144	5907558401981

### Wkrętki

Screwdriver set / Schraubendreher / Отвертки / Відкрутки, набір / Csavarhúzó készlet / Set şurubelişte / Šroubováky / Súprava skrutkovačov+bity / Komplet izvijačev / Atsuktuvų komplektas / Skrūvgriežu komplekts / Krūvīķerģaļe komplekt / Отвертки компл. / Odvijač / Odvijac set / Συλλογή καταβιδιών / Destornilladores / Cacciaviti / Chaves de fenda / Tournevis / Schroevendraaiers

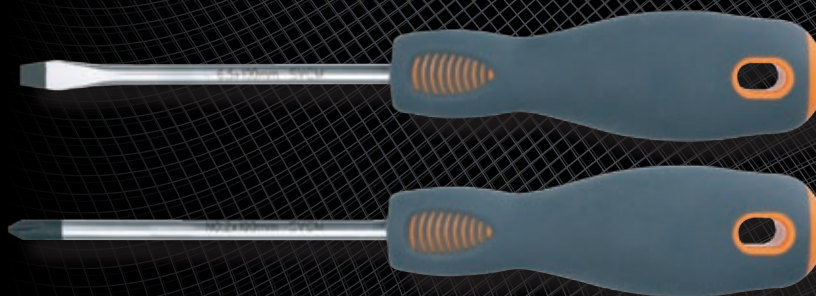

- płaski 6x100 mm
- krzyżowy PH2x100 mm
- slotted screwdriver 6x100 mm
- cross slotted screwdriver PH2x100 mm
- плоская 6x100 мм
- крестовая PH2x100 мм

Ref.			EAN
04-202	6	48	5907558402247

### Wkrętki

Screwdriver set / Schraubendreher / Отвертки / Відкрутки, набір / Csavarhúzó készlet / Set şurubelişte / Šroubováky / Súprava skrutkovačov+bity / Komplet izvijačev / Atsuktuvų komplektas / Skrūvgriežu komplekts / Krūvīķerģaļe komplekt / Отвертки компл. / Odvijač / Odvijac set / Συλλογή καταβιδιών / Destornilladores / Cacciaviti / Chaves de fenda / Tournevis / Schroevendraaiers

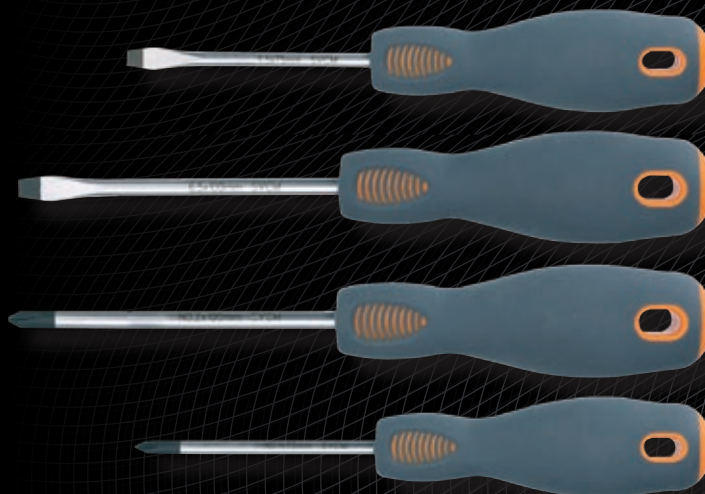

- płaski 5x75 mm, 6x100 mm
- krzyżowy PH1x75 mm, PH2x100 mm
- slotted screwdriver 5x75mm, 6x100 mm
- cross slotted screwdriver PH1x75 mm, PH2x100 mm
- плоская 5x75 мм, 6x100 мм
- крестовая PH1x75 мм, PH2x100 мм

Ref.			EAN
04-204	6	36	5907558402254

### Wkrętak płaski do pobijania

Slotted screwdriver go through / Schraubendreher, flach / Отвертка шлицевая ударная / Відкрутка плоска, ударна / Üthető lapos csavarhúzó / Surubeliştá impact varf drept / Šroubovák plochý úderový / Sekáci plochý skrutkovač / Ploščati izvijač za zabijanje / Smitiginis, ploščias atsuktuvus / Plakanais skrūvgriezis / Lame löökrūvīķerģaļe / Отвертка плоска ударна / Plosnati odvijač za nabijanje / Plosnati odvijač za zabijanje / Καταβιδί κρούσης επίπεδο / Destornillador plano de golpe / Cacciavite piatto a maglietta / Chave de fenda plano p. malhar / Tournevis à fourche à frapper / Vlakke slagschroevendraaier



Ref.	$\ominus$ [mm]	L [mm]	L <sub>1</sub> [mm]	$\emptyset$ [mm]			EAN
04-017	5,5	180	75	5,5	12	240	5907558403237
04-018	5,5	205	100	5,5	12	144	5907558403244
04-019	6,5	240	125	7,0	12	144	5907558403251
04-020	8,0	280	150	9,0	6	120	5907558403268
04-005	10,0	325	200	9,5	6	60	5907558411676

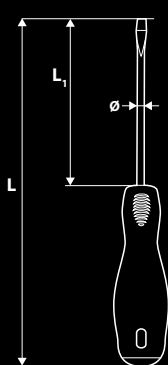

## Wkrętak krzyżowy do pobijania

Screwdriver go through phillips / Kreuzschraubendreher zum Klopfen / Отвертка крестовая усиленная ударная / Відкрутка хрестовидна ударна / Csavarhúzó phillips / Surubelnija cruciulija p/u spargere / Šroubovák křížový úderový / Skrutkovač úderový PHillips / Ploščati izvijač, udarni / Kryžminis, smūginis atsuktuvus / Skrūvgriezis krusta PH siltiena / Ristpeakruvikeeraja / Отвертка / Одвијач / Одвијач / Σταυρωτό καταβίβι τύπου phillips / Destornillador de golpe phillips / Cacciavite crociforme a maglietta / Chave de fenda de cruzeta p. malhar / Tournevis en croix à frapper / Slagkrusschroevendraaier

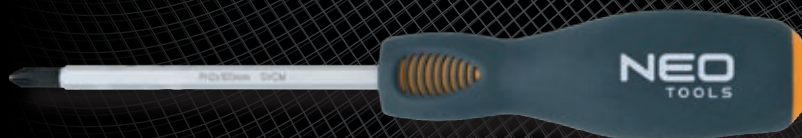

Ref.	⊕	L[mm]	L <sub>1</sub> [mm]	ø[mm]	📦	📦	EAN
04-027	PH1	180	75	5	12	240	5907558403275
04-028	PH2	215	100	7	12	144	5907558403282
04-029	PH2	270	150	7	12	144	5907558403299

## Wkrętaki do pobijania

Go through screwdrivers / Schraubendreher zum Aufheben / Отвертки ударные / Викрутки ударні / Üthető csavarhúzó / Surubelnija de impact / Šroubováky úderové / Sekacie skrutkovače / Izvijači za zabijanje / Smūginiai suktuvai / Trečieniskrūvgrieži / Löökkruvikeerajad / Ударни отвертки / Одвијачи за набijanje / Одвијаче за забijanje / Καταβίβια κρούσης / Destornilladores de golpe / Cacciaviti a maglietta / Chaves de fenda p. malhar / Tournevis à frapper / Slagschroevendraaiers

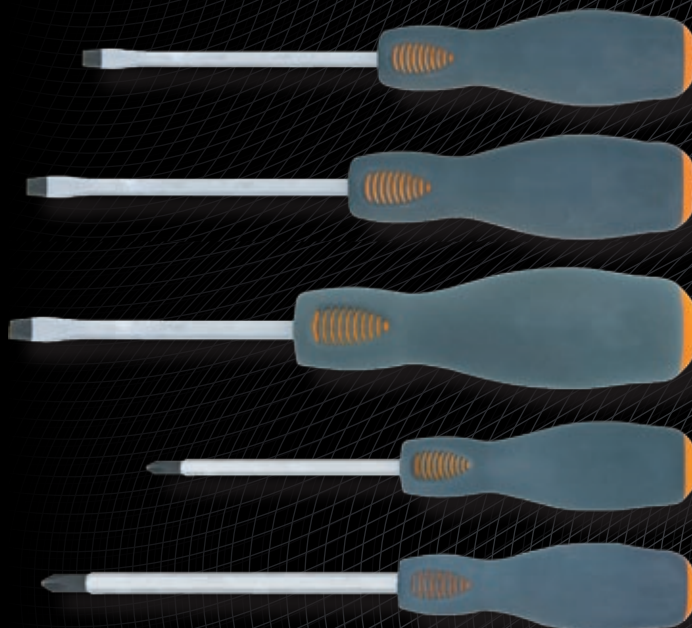

- płaski 5.5 x 100 mm, 6.5 x 125 mm, 8 x 150 mm,  
- krzyżowy PH1x75, PH2x100

- slotted screwdriver 5.5x100 mm, 6.5 x 125 mm, 8 x 150 mm  
- cross slotted screwdriver PH1x75 mm, PH2x100 mm

- плоская 5.5 x 100 мм, 6.5 x 125 мм, 8 x 150 мм  
- крестовая PH1x75мм, PH2x100 мм

Ref.	📦	📦	EAN
04-240	6	24	5907558412857

## Wkrętak precyzyjny płaski

Slotted precision screwdriver / Feinschraubendreher, flach / Отвертка прецизионная шлицевая / Викрутка прецизійна, плоска / Műszerész lapos csavarhúzó / Surubelnija de precizie, varf drept / Šroubovák precizní ploché / Precizny ploché skrutkovač / Precizni ploščati izvijač / Atsuktuvus plokščias, torcinis / Precizėjašais plakanaisskrūvgriezis / Lame peenkruvikeeraja / Отвертка плоская прецизна / Precizni plosnati odvijáč / Precizni pljosnati odvijáč / Καταβίβια ακριβείας επίπεδα / Destornillador plano de precisión / Cacciavite di precisione piatto / Chave de fenda precisa plano / Tournevis de précision à fourche / Vlakke fijnschroevendraaier



Ref.	⌀[mm]	L[mm]	L <sub>1</sub> [mm]	ø[mm]	📦	📦	EAN
04-081	1,5	135	40	2,5	12	480	5907558402100
04-082	2,0	135	40	2,5	12	480	5907558402117
04-083	2,5	135	40	2,5	12	480	5907558402124
04-084	3,0	135	40	3	12	480	5907558402131

### Wkrętak precyzyjny krzyżowy PH

Cross slotted precision screwdriver / Feinschraubendreher, Kreuz / Отвертка прецизионная крестовидная / Викрутка прецизійна, хрестовидна / Műszerész kereszt csavarhúzó / Surubelhiță de precizie, varf cruce / Šroubovák precizní křížový / Precizny krížový skrutkovač / Křížní precizní izvijač / Atsuktuvos precizinis, kryžminis / Precizējošais krustveida skrūvgriezis / Lame ristpeakruvikeeraja / Отвертка прецизна кръстата / Precizni križni odvijač / Precizni kukasti odvijač / Σταυροκατάρτιδο ακριβείας / Destornillador de precisión phillips / Cacciavite di precisione a croce / Chave de fenda precisa de cruzeta / Tournevis de précision en croix / Fijnkrusschroevendraaier

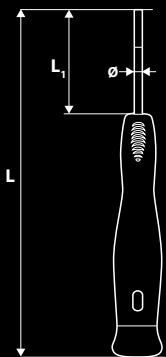

Ref.	⊕	L[mm]	L <sub>1</sub> [mm]	ø[mm]	☞	☝	EAN
04-085	PH00	135	40	2,5	12	480	5907558402148
04-086	PH0	135	40	3	12	480	5907558402155
04-087	PH1	135	40	4	12	480	5907558402162

### Wkrętak precyzyjny krzyżowy PZ

Cross slotted precision screwdriver / Feinschraubendreher, Kreuz / Отвертка прецизионная крестовидная / Викрутка прецизійна, хрестовидна / Műszerész kereszt csavarhúzó / Surubelhiță de precizie, varf cruce / Šroubovák precizní křížový / Precizny krížový skrutkovač / Křížní precizní izvijač / Atsuktuvos precizinis, kryžminis / Precizējošais krustveida skrūvgriezis / Lame ristpeakruvikeeraja / Отвертка прецизна кръстата / Precizni križni odvijač / Precizni kukasti odvijač / Σταυροκατάρτιδο ακριβείας / Destornillador de precisión phillips / Cacciavite di precisione a croce / Chave de fenda precisa de cruzeta / Tournevis de précision en croix / Fijnkrusschroevendraaier

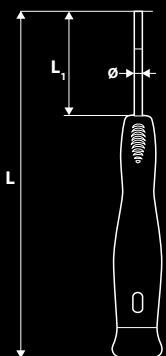

Ref.	⊕	L[mm]	L <sub>1</sub> [mm]	ø[mm]	☞	☝	EAN
04-088	PZ0	135	40	3	12	480	5907558402179
04-089	PZ1	135	40	4	12	480	5907558402186

### Wkrętak precyzyjny Torx

Precision Torx screwdriver / Feinschraubendreher, Torx / Отвертка прецизионная Torx / Викрутка прецизійна «Торх» / Műszerész Torx csavarhúzó / Surubelhiță de precizie, varf Torx / Šroubovák precizní Torx / Precizny skrutkovač Torx / Precizni izvijač Torx / Atsuktuvos precizinis, torcinis / Precizējošais Torx skrūvgriezis / Lame Torx-kruvikeeraja / Прецизна отвертка Torx / Precizni odvijač Torx / Precizni Torx odvijač / Σταυροκατάρτιδο ακριβείας Torx / Destornillador de precisión torx / Cacciavite di precisione Torx / Chave de fenda precisa Torx / Tournevis de précision Torx / Torx fijn Schroevendraaier

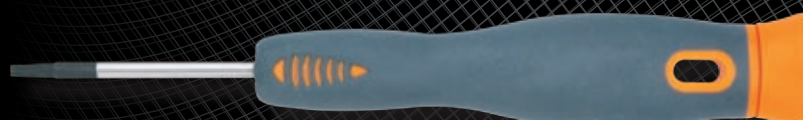
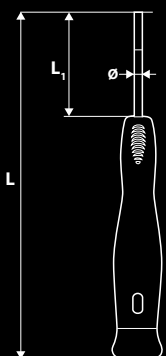

Ref.	⊕	L[mm]	L <sub>1</sub> [mm]	ø[mm]	☞	☝	EAN
04-091	T6	135	40	2,5	12	480	5907558402193
04-092	T7	135	40	2,5	12	480	5907558402209
04-093	T8	135	40	2,5	12	480	5907558402216
04-094	T9	135	40	3	12	480	5907558402223



### Wkrętaki precyzyjne

Precision screwdriver set / Präzisionsschraubendreher / Отвертки прецизионные / Відкртки прецизійні, набір / Műszerész csavarhúzókészlet / Set surubelnite / Šroubováky jemná mech. / Súpava mikroskrutkovačov / Garnitura natančnih izvijačev / Atsuktuvai tikslieks darbars / Skrūvgriežu komplekts / Täppiskruvikeerajate komplekt / Отвертки компл. / Odvijač / Odvijač set / Συλλογή κατασβιδίων ακριβείας / Destornilladores de precisión / Cacciaviti di precisione / Chaves de fenda precisas / Tournevis de précision / Fijnschroevendraaiers

**x5**

**SVC**  
steel

**25**  
years  
guarantee

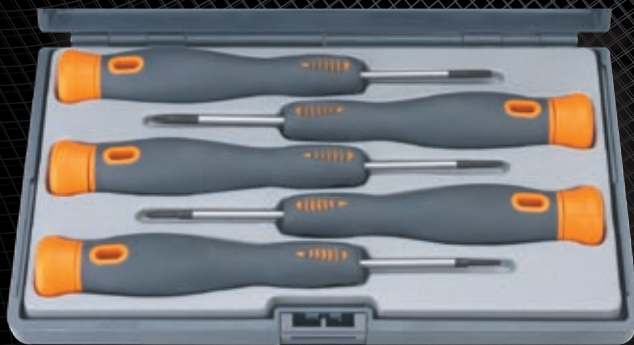

- płaskie 1.5x40 mm, 2.0x40 mm, 2.5x40 mm
- krzyżowe PH00x40 mm, PH0x40 mm
- slotted screwdrivers 1.5x40 mm, 2.0x40 mm, 2.5x40 mm
- cross slotted screwdrivers PH00x40 mm, PH0x40 mm
- плоские: 1.5x40 мм, 2.0x40 мм, 2.5x40 мм
- крестовые: PH00x40 мм, PH0x40 мм

Ref.	📦	📦	EAN
04-225	6	24	5907558402285

### Wkrętaki precyzyjne Torx

Precision Torx screwdriver / Feinschraubendreher, Torx / Отвертка прецизионная Torx / Відкртка прецизійна «Torx» / Műszerész Torx csavarhúzó / Surubelnita de precizie, varf Torx / Šroubováky precizní Torx / Precizny skrutkovač Torx / Precizni izvijač Torx / Atsuktuvas precizinis, torcinis / Precizjošais Torx skrūvgriezis / Lame Torx-kruvikeeraja / Прецизна отвертка Torx / Precizni odvijač Torx / Precizni Torx odvijač / Σταυροκασβιδιο ακριβείας Torx / Destornillador de precisión torx / Cacciavite di precisione Torx / Chave de fenda precisa Torx / Tournevis de précision Torx / Torx fijnschroevendraaiers

**x6**

**SVC**  
steel

**25**  
years  
guarantee

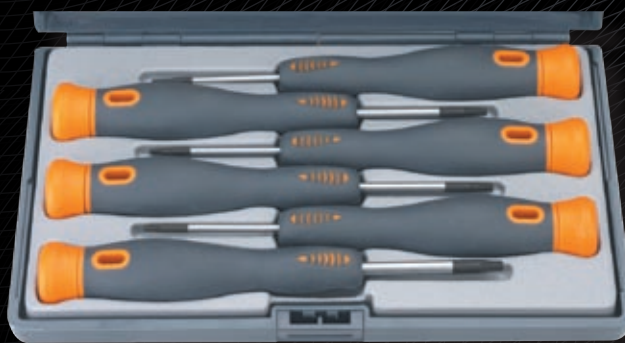

- Torx T6x40 mm, T7x40 mm, T8x40 mm, T9x40 mm, T10x40 mm, T15x40 mm
- Torx T6x40 mm, T7x40 mm, T8x40 mm, T9x40 mm, T10x40 mm, T15x40 mm
- Torx T6x40 mm, T7x40 mm, T8x40 mm, T9x40 mm, T10x40 mm, T15x40 mm

Ref.	📦	📦	EAN
04-226	6	24	5907558402292

### Wkrętaki precyzyjne

Precision screwdriver set / Präzisionsschraubendreher / Отвертки прецизионные / Відкртки прецизійні, набір / Műszerész csavarhúzókészlet / Set surubelnite / Šroubováky jemná mech. / Súpava mikroskrutkovačov / Garnitura natančnih izvijačev / Atsuktuvai tikslieks darbars / Skrūvgriežu komplekts / Täppiskruvikeerajate komplekt / Отвертки компл. / Odvijač / Odvijač set / Συλλογή κατασβιδίων ακριβείας / Destornilladores de precisión / Cacciaviti di precisione / Chaves de fenda precisas / Tournevis de précision / Fijnschroevendraaiers

**x8**

**SVC**  
steel

**25**  
years  
guarantee



- uchwyt
- 7 dwustronnych bitów 120 mm
- końcówki płaskie: 1.5, 2.0, 3.0 mm
- końcówki krzyżowe: PH000, PH00, PH0
- końcówki Torx: T5, T6, T7, T8
- końcówki sześciokątne: H1.5, H2.0, H2.5, H3.0 mm
- holder
- 7 double sided bits 120 mm
- flat tips: 1.5, 2.0, 3.0 mm
- cross tips: PH000, PH00, PH0
- Torx tips: T5, T6, T7, T8
- hexagonal tips: H1.5, H2.0, H2.5, H3.0
- держатель
- 7 двусторонних вставок-отверток (битов) 120 мм
- наконечники плоские: 1.5, 2.0, 3.0 мм
- наконечники крестовые: PH000, PH00, PH0
- наконечники Torx: T5, T6, T7, T8
- наконечники шестиугольные: 1.5, 2.0, 2.5, 3.0 мм

Ref.	📦	📦	EAN
04-227	6	24	5907558402308

### Wkrętaki precyzyjne

Precision screwdriver set / Präzisionsschraubendreher / Отвертки прецизионные / Відкрутки прецизійні набір / Műszerész csavarhúzókészlet / Set şurubelnițe / Šroubováky jemná mech. / Súprava mikroskrutkovačov / Garnitura natančnih izvijačev / Atsuktuvai tiksliams darbams / Skrūvgriežu komplekts / Tāpiskrūvikeerajate komplekt / Отвертки компн. / Odvijač / Odvijač set / Συλλογή καταβιδιών ακριβείας / Destornilladores de precisión / Cacciaviti di precisione / Chaves de fenda precisas / Tournevis de précision / Fijnschroevendraaiers



- uchwyt
- 16 końcówek wkrętakowych 30 mm
- końcówki płaskie: 2.0, 2.5, 3.0 mm
- końcówki krzyżowe: PH00, PH0, PH1, PZ00, PZ0
- końcówki Torx: T6, T7, T8, T9, T10
- końcówki sześciokątne: H1.5, H2.0, H2.5
- holder
- 16 driver bits 30 mm
- flat tips: 2.0, 2.5, 3.0 mm
- cross tips: PH00, PH0, PH1, PZ00, PZ0
- Torx tips: T6, T7, T8, T9, T10
- hexagonal tips: H1.5, H2.0, H2.5
- держатель
- 16 насадок 30 мм
- наконечники плоские: 2.0, 2.5, 3.0 мм
- наконечники крестовые: PH00, PH0, PH1, PZ00, PZ0
- наконечники Torx: T6, T7, T8, T9, T10
- наконечники шестиугольные: H1.5, H2.0, H2.5

Ref.	📦	📦	EAN
04-228	6	36	5907558410068

### Wkrętak odwracalny

Reversible screwdriver / Schraubendreher, umwendbar / Отвертка универсальная / Відкрутка универсальна, з двобічними знімними наконечниками / Csavarhúzó cserélhető hegygel / Šurubelniță cu varf dublu, reversibil / Šroubovák oboustranný / Otáčací skrutkovač / Dvosmerni izvijač / Atsuktuvus su keičiamais antgaliais / Universālais skrūvgriezis / Pööratava peaga kruvikeeraja / Универсална отвертка / Povratni odvijač / Povratni odvijač / Καταβιδί γενικής χρήσης / Destornillador reversible / Cacciavite reversibile / Chave de fenda reversível / Tournevis réversible / Omkeerbare schroevendraaier

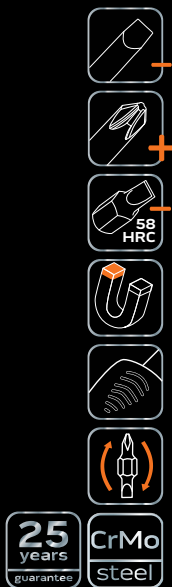

- dwustronna końcówka wkrętakowa
- płaski 6x38 mm
- krzyżowy PH2x38 mm
- two-sided tip blade
- slotted tip 6x38 mm
- cross slotted tip PH2x38 mm
- двусторонний стержень с разными наконечниками
- плоский наконечник 6x38 мм
- крестовый наконечник PH2x38 мм

Ref.	📦	📦	EAN
04-201	12	144	5907558402230

### Wkrętak z giętkim grotem

Screwdriver with flexible shank with bits / Schraubendreher mit flex. Spitze / Отвертка с гибким стержнем / Відкрутка з жалом на шарнірі / Csavarhúzó készlet flexibilis nyéllal / Şurubelniță cu corp flexibil cu varf / Šroubovák s pružným hrotem / Skrutkovač Flexi-Bity / Izvijač s pregibno konico / Atsuktuvus su lankščia šerdimi / Skrūvgriezis ar lokano galu uzgaļiem / Painduva käepidemega kruvikeeraja / Отвертка с Накрайницею / Odvijač / Καταβιδί με εύκαμπτη λαβή και οστ μωτών / Destornillador con vástago flexible + puntas / Cacciavite con la punta flessibile / Chave de fenda com ponta flexível / Tournevis à pointe douce / Schroevendraaier met zachte eindstuk

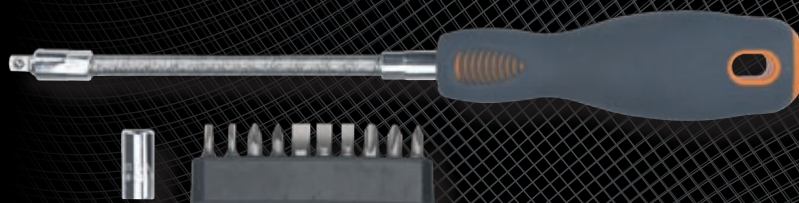
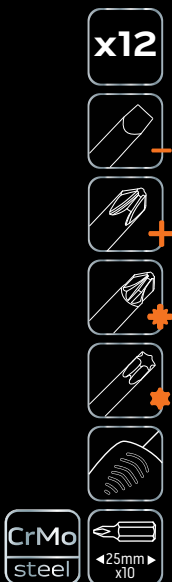

- adapter do końcówek
- bity: 25 mm
- płaskie 5, 6, 7 mm
- krzyżowe: PH1, PH2, PH3, PZ1, PZ2
- Torx T15, T20
- bit adapter
- bits: 25 mm
- flat 5, 6, 7 mm
- cross: PH1, PH2, PH3, PZ1, PZ2
- Torx T15, T20
- адаптер для наконечников
- вставки-отвертки (биты): 25 мм
- плоские: 5 мм, 6 мм, 7 мм
- крестовые: PH1, PH2, PH3, PZ1, PZ2
- Torx T15, T20

Ref.	📦	📦	EAN
04-212	6	36	5907558402261

## Komplet narzędzi hakowatych

Hooks / Hacken / Крюки / Гаки / Horgok / Cârlige / Háky / Skoby / Kljuke / Kabliat / Āķi / Haagid / Кюки / Kuke / Kuke / Γάντζοι / Ganchos / Ganci / Anzais / Crochets / Haken

x4  
CrV  
steel  
25  
years  
guarantee



Ref.	📦	📦	EAN
04-230	6	48	5907558410075

## Wkrętak udarowy

Impact screwdriver / Schlag-Schraubendreher / Отвертка ударная / Вікрутка ударна / Ütvecsavarozó / Surubelnitā cu percutor / Šroubovák rázový / Rázový skrutkovač / Udarni izvijač / Smūginis suktuvus / Trieciens skrūvgriezis / Lõõkkruvikeeraja / Ударна отвёртка / Odvijač s udarom / Udarni odvijač / Καταβίβι κρούσης / Destornillador de impacto / Cacciavite a percussione / Chave de fenda de impacto / Tournevis à chocs / Slagschroevendraaier



5, 6, 8, 10, 12, 14 mm  
PH1, PH2, PH3



x11  
S2  
steel  
CrV  
steel  
25  
years  
guarantee



- płaskie 5, 6, 8, 10, 12, 14 mm
- krzyżowe PH1, PH2, PH3
- slotted screwdrivers 5, 6, 8, 10, 12, 14 mm
- cross slotted screwdrivers PH1, PH2, PH3
- плоские: 5, 6, 8, 10, 12, 14 мм
- крестовые: PH1, PH2, PH3

Ref.	m[kg]	📦	📦	EAN
04-250	1,2	12	600	5907558410082

## Wkrętak płaski 1000V

Screwdriver slotted / Flachsraubendreher / Отвертка плоская / Відкрутка плоска / Csavarhúzó / Surubelnitā platā / Šroubovák plochý / Skrutkovač plochý / Ploščati izvijač / Plokščias atsuktuvus / Skrūvgriezis plakans / Laterepa-kruvikeeraja / Отвёртка / Odvijač / Odvijac / Καταβίβι εγκοπής / Destornillador plano / Cacciavite piatto / Chave de fenda plana / Tournevis à fourche / Vlakke schroevendraaier

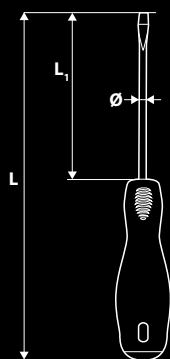

1000V  
SVC  
steel  
25  
years  
guarantee



Ref.	⌀	L[mm]	L <sub>1</sub> [mm]	Ø [mm]	📦	📦	EAN
04-051	2,5	150	75	2,5	12	600	5907558401998
04-052	3,0	175	100	3	12	240	5907558402001
04-053	4,0	205	100	4	12	240	5907558402018
04-054	5,5	230	125	5,5	12	144	5907558402025
04-055	6,5	270	150	6,5	12	144	5907558402032

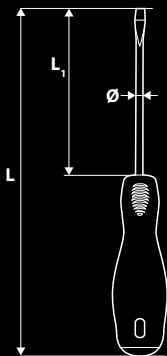

### Wkrętak krzyżowy PZ 1000V

Screwdriver Pozidriv / Kreuzschraubendreher / Отвертка крестовая / Відкрітка хрестовидна / Csavarhúzó pozidriv / Şurubelniță tip „Pozidriv” / Šroubovák křížový / Skrutkovač PZ / Křížni izvijač / Kryžminis atsuktuvos Phillips / Skrūvgriezis krusta PZ / Ristpeakruvikeeraja Pozidriv / Отвертка / Odvijač / Odvijac / Καταβίδι τύπου pozidriv / Destornillador phillips / Cacciavite crociforme / Chave de fenda de cruzeta / Tournevis en croix / Kriusschroevendraaier



Ref.	⊕	L[mm]	L <sub>1</sub> [mm]	Ø [mm]	☞	☝	EAN
04-061	PZ0	135	60	3	12	600	5907558402049
04-062	PZ1	190	80	4,5	12	240	5907558402056
04-063	PZ2	217	100	6	12	144	5907558402063

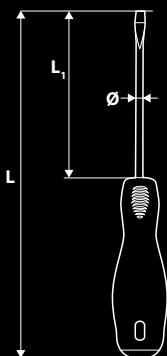

### Wkrętak krzyżowy PH 1000V

Screwdriver Phillips / Kreuzschraubendreher / Отвертка крестовая / Відкрітка хрестовидна / Csavarhúzó phillips / Şurubelniță tip „Phillips” / Šroubovák křížový / Skrutkovač PH / Křížni izvijač / Kryžminis atsuktuvos Phillips / Skrūvgriezis krusta PH / Ristpeakruvikeeraja / Отвертка / Odvijač / Odvijac / Καταβίδι τύπου phillips / Destornillador phillips / Cacciavite crociforme / Chave de fenda de cruzeta / Tournevis en croix / Kriusschroevendraaier



Ref.	⊕	L[mm]	L <sub>1</sub> [mm]	Ø [mm]	☞	☝	EAN
04-071	PH0	135	60	3	12	600	5907558402070
04-072	PH1	190	80	4,5	12	240	5907558402087
04-073	PH2	215	100	6	12	144	5907558402094

### Wkrętaki 1000V

Screwdriver set / Schraubendreher / Отвертки / Відкрітки, набір / Csavarhúzó készlet / Set şurubelnițe / Šroubováky / Súprava skrutkovačov+bity / Komplet izvijačev / Atsuktuvų komplektas / Skrūvgriežu komplekts / Krūvikeerajate komplekt / Отвертки компл. / Odvijač / Odvijac set / Συλλογή καταβιδιών / Destornilladores / Cacciaviti / Chaves de fenda / Tournevis / Schroevendraaiers

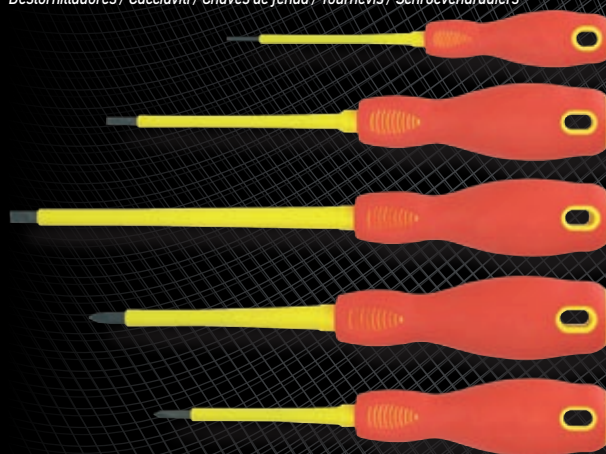

- плоские: 2,5x75 мм, 4x100 мм, 6,5x150 мм  
- krzyżowy: PH1x80 мм, PH2x100 мм  
- slotted screwdrivers: 2,5x75 mm, 4x100 mm, 6,5x150 mm  
- cross slotted screwdrivers: PH1x80 mm, PH2x100 mm  
- крестовые: PH1x80 мм, PH2x100 мм

Ref.	☞	☝	EAN
04-220	6	36	5907558402278

## Wkrętak płaski 1000V

Screwdriver slotted / Flachsraubendreher / Отвертка плоская / Відкрітка плоска / Csavarhúzó / Šurubelnija platā / Šraubovák plochý / Skrutkovač plochý / Ploščati izvijač / Ploščias atsuktuvas / Skrūvgriezis plakans / Лампеа-krivikeeraja / Отвертка / Одвијач / Одвијач / Καταβίβι εγκοπή / Destornillador plano / Cacciavite piatto / Chave de fenda plana / Tournevis à fourche / Vlakke schroevendraaier

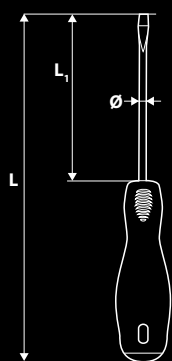

Ref.	⌀	L[mm]	📦	📦	EAN
04-150	2,5	75	1	1	5907558416282
04-151	3	100	1	1	5907558416299
04-152	4	100	1	1	5907558416305
04-153	5,5	125	1	1	5907558416312
04-154	6,5	150	1	1	5907558416329
04-155	8	175	1	1	5907558416336

## Wkrętak krzyżowy PZ 1000V

Screwdriver Pozidriv / Kreuzschraubendreher / Отвертка крестовая / Відкрітка крестовидна / Csavarhúzó pozidriv / Šurubelnija tip „Pozidriv” / Šraubovák křížový / Skrutkovač PZ / Křížni izvijač / Kryžminis atsuktuvas Phillips / Skrūvgriezis krusta PZ / Ristpeakruvikeeraja Pozidriv / Отвертка / Одвијач / Одвијач / Καταβίβι τύπου pozidriv / Destornillador phillips / Cacciavite crociforme / Chave de fenda de cruzeta / Tournevis en croix / Kruisschroevendraaier

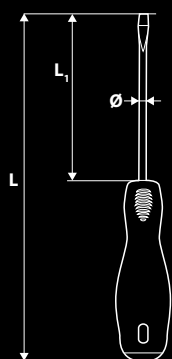

Ref.	⊕	L[mm]	📦	📦	EAN
04-156	PZ0	60	1	1	5907558416343
04-157	PZ0	100	1	1	5907558416350
04-158	PZ1	80	1	1	5907558416367
04-159	PZ1	150	1	1	5907558416374
04-160	PZ2	100	1	1	5907558416381
04-161	PZ2	175	1	1	5907558416398
04-162	PZ3	150	1	1	5907558416404
04-163	PZ3	200	1	1	5907558416411

## Wkrętak krzyżowy PH 1000V

Screwdriver Phillips / Kreuzschraubendreher / Отвертка крестовая / Відкрітка крестовидна / Csavarhúzó phillips / Šurubelnija tip „Phillips” / Šraubovák křížový / Skrutkovač PH / Křížni izvijač / Kryžminis atsuktuvas Phillips / Skrūvgriezis krusta PH / Ristpeakruvikeeraja / Отвертка / Одвијач / Одвијач / Καταβίβι τύπου phillips / Destornillador phillips / Cacciavite crociforme / Chave de fenda de cruzeta / Tournevis en croix / Kruisschroevendraaier

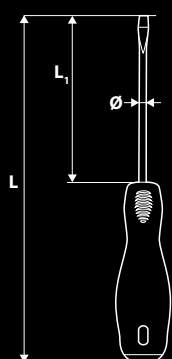

Ref.	⊕	L[mm]	📦	📦	EAN
04-164	PH0	60	1	1	5907558416428
04-165	PH1	80	1	1	5907558416435
04-166	PH1	150	1	1	5907558416442
04-167	PH2	100	1	1	5907558416459
04-168	PH2	175	1	1	5907558416466
04-169	PH3	150	1	1	5907558416473
04-170	PH3	200	1	1	5907558416480



x9



CrMo  
steel

25  
years  
guarantee



### Wkrętki 1000V

Screwdriver set / Schraubendreher / Отвертки / Відкрутки, набір / Csavarhúzó készlet / Set şurubelişte / Šroubováky / Súprava skrutkovačov+bity / Komplet izvijačev / Atsuktuvų komplektas / Skruvgriežu komplekts / Kruvikeerajate komplekt / Отвертки компл. / Одвijač / Odvijač set / Συλλογή καταβιδιών / Destornilladores / Cacciaviti / Chaves de fenda / Tournevis / Schroevendraaiers



3 x 100 mm, 4 x 100 mm, 5 x 100 mm, 6.5 x 100 mm, 8 x 175 mm  
PH0 60 mm, PH1 80 mm, PH2 100, PH3 150 mm

Ref.			EAN
04-260	1	1	5907558407501



x9



CrMo  
steel

25  
years  
guarantee



### Wkrętki 1000V

Screwdriver set / Schraubendreher / Отвертки / Відкрутки, набір / Csavarhúzó készlet / Set şurubelişte / Šroubováky / Súprava skrutkovačov+bity / Komplet izvijačev / Atsuktuvų komplektas / Skruvgriežu komplekts / Kruvikeerajate komplekt / Отвертки компл. / Одвijač / Odvijač set / Συλλογή καταβιδιών / Destornilladores / Cacciaviti / Chaves de fenda / Tournevis / Schroevendraaiers



3 x 100 mm, 4 x 100 mm, 5.5 x 125 mm, 6.5 x 150 mm, 8 x 175 mm  
PH0 60 mm, PH1 80 mm, PH2 100 mm, PH3 150 mm

Ref.			EAN
04-261	1	1	5907558407532

## Końcówki wkrętakowe

Driver bits / Einsätze für Schraubendreher / Насадки / Наконечники вкрутки / Csavarhúzó betétek / Set biti / Šroubovákové nástavce / Skrutkovacie nástavce / Nastavki za izvijače / Atsuktuvo antgaliai / Skrūvgrieža uzgali / Krūvikeerajaotsakud / Накрайници за отвёртка / Nastavci za odvijač / Nastavci za odvijač / Καταβιδόμενες / Puntas destornilladoras / Punte per cacciaviti / Ponteiros de chave de fenda / Embouts de tournevis / Schroevendraaiereindstukken



Ref.	⊕	L[mm]	☞	☝	EAN
06-006	PH2	25	50	200	5907558402988

## Końcówki wkrętakowe

Driver bits / Einsätze für Schraubendreher / Насадки / Наконечники вкрутки / Csavarhúzó betétek / Set biti / Šroubovákové nástavce / Skrutkovacie nástavce / Nastavki za izvijače / Atsuktuvo antgaliai / Skrūvgrieža uzgali / Krūvikeerajaotsakud / Накрайници за отвёртка / Nastavci za odvijač / Nastavci za odvijač / Καταβιδόμενες / Puntas destornilladoras / Punte per cacciaviti / Ponteiros de chave de fenda / Embouts de tournevis / Schroevendraaiereindstukken



Ref.	⊕	L[mm]	☞	☝	EAN
06-011	PH2	25	12	120	5907558406351

## Końcówki wkrętakowe

Driver bits / Einsätze für Schraubendreher / Насадки / Наконечники вкрутки / Csavarhúzó betétek / Set biti / Šroubovákové nástavce / Skrutkovacie nástavce / Nastavki za izvijače / Atsuktuvo antgaliai / Skrūvgrieža uzgali / Krūvikeerajaotsakud / Накрайници за отвёртка / Nastavci za odvijač / Nastavci za odvijač / Καταβιδόμενες / Puntas destornilladoras / Punte per cacciaviti / Ponteiros de chave de fenda / Embouts de tournevis / Schroevendraaiereindstukken

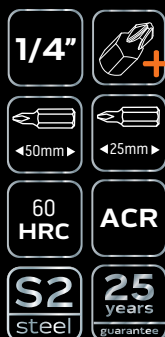

- ACR - precyzyjne radelkowanie grzałow zapewnia mocny i pewny kontakt  
- ACR – precision knurling of blades ensures strong and firm contact  
- ACR – точная накатка стержней обеспечивает надежность работы

Ref.	⊕	L[mm]	☞	☝	EAN	
06-035	PH2	25	x5	50	200	5907558403114
06-036	PH2	25	x10	50	150	5907558403121
06-037	PH2	50	x5	50	200	5907558403138

## Końcówki wkrętakowe

Driver bits / Einsätze für Schraubendreher / Насадки / Наконечники вкрутки / Csavarhúzó betétek / Set biti / Šroubovákové nástavce / Skrutkovacie nástavce / Nastavki za izvijače / Atsuktuvo antgaliai / Skrūvgrieža uzgali / Krūvikeerajaotsakud / Накрайници за отвёртка / Nastavci za odvijač / Nastavci za odvijač / Καταβιδόμενες / Puntas destornilladoras / Punte per cacciaviti / Ponteiros de chave de fenda / Embouts de tournevis / Schroevendraaiereindstukken



Ref.	⊕	L[mm]	☞	☝	EAN	
06-016	PZ2	25	x5	50	200	5907558403008
06-020	PZ2	25	x20	50	150	5907558403015



### Końcówki wkrętakowe

Driver bits / Einsätze für Schraubendreher / Насадки / Наконечники викртові / Csavarhúzó betétek / Set biti / Šroubovákové nástavce / Skrutkovacie nástavce / Nastavki za izvijače / Atsuktuno antgaliai / Skūvgrieža uzgalis / Krūvikeerajaotsakud / Накрайници за отвертка / Nastavci za odvijač / Nastavci za odvijač / Καταβιδόμενες / Puntas destornilladoras / Punte per cacciaviti / Ponteiros de chave de fenda / Embouts de tournevis / Schroevendraaiereindstukken



- ACR - precyzyjne radetkowanie grótów zapewnia mocny i pewny kontakt - ACR - precision knurling of blades ensures strong and firm contact - ACR - точная накатка стержней обеспечивает надежность работы

Ref.	⊕	L[mm]	⊞	⊞	⊞	EAN
06-038	PZ2	25	x5	50	200	5907558403145
06-039	PZ2	50	x5	50	200	5907558403152

### Końcówki wkrętakowe

Driver bits / Einsätze für Schraubendreher / Насадки / Наконечники викртові / Csavarhúzó betétek / Set biti / Šroubovákové nástavce / Skrutkovacie nástavce / Nastavki za izvijače / Atsuktuno antgaliai / Skūvgrieža uzgalis / Krūvikeerajaotsakud / Накрайници за отвертка / Nastavci za odvijač / Nastavci za odvijač / Καταβιδόμενες / Puntas destornilladoras / Punte per cacciaviti / Ponteiros de chave de fenda / Embouts de tournevis / Schroevendraaiereindstukken



- do płyt gipsowo-kartonowych - końcówki krzyżowe PH2 - for gypsum boards - Philips PH2 bits - для гипсокартонных плит - насадки PH2

Ref.	⊞	⊞	EAN
06-040	24	192	5907558410099

### Uchwyt do końcówek

Bit holder / Aufnahme für Spitzen / Зажим для наконечников / Тримач до наконечників / Hajtószer / Dispozitiv de prinderea capetelor / Skličidlo na nástavce / Upinadlo na nástavce / Vpenjalo za nastavke / Laikiklis antgaliams / Uzgalis patrona / Otsakupadrin / Държач за накрайници / Drška za nastavke / Hvat za nastavke / Προσαρμογέας μπιτών / Mandril de sujeción para puntas / Portainserti / Suporte de ponteiros / Manche pour embouts / Houder voor eindstukken

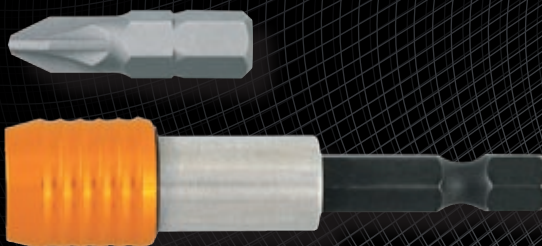

Ref.	L[mm]	⊞	⊞	EAN
06-070	65	10	100	5907558403497



### Uchwyt do końcówek

Bit holder / Aufnahme für Spitzen / Зажим для наконечников / Тримач до наконечників / Hajtószer / Dispozitiv de prinderea capetelor / Skličidlo na nástavce / Upinadlo na nástavce / Vpenjalo za nastavke / Laikiklis antgaliams / Uzgalis patrona / Otsakupadrin / Държач за накрайници / Drška za nastavke / Hvat za nastavke / Προσαρμογέας μπιτών / Mandril de sujeción para puntas / Portainserti / Suporte de ponteiros / Manche pour embouts / Houder voor eindstukken



Ref.	L[mm]	⊞	⊞	EAN
06-072	150	12	96	5907558410105
06-073	300	12	48	5907558410112





## Uchwyt do końcówek

Bit holder / Aufnahme für Spitzen / Зажим для наконечников / Тримач до наконечників / Hajtószer / Dispozitiv de prinderea capetelor / Skličadlo na nástavce / Upínadlo na nástavce / Vpenjalo za nastavke / Laikiklis antgalams / Uzgāju patrona / Otsakupadrin / Держач за наконечники / Drška za nastavke / Hvat za nastavke / Προσαρμογέας μπιτών / Mandril de sujeción para puntas / Portainserți / Suporte de ponteiros / Manche pour embouts / Houder voor eindstukken

1/4"

CrV  
steel25  
years  
guarantee

Ref.	L[mm]			EAN
06-071	60	10	100	5907558405385

## Grzechotka

Ratchet handle / Ratsche / Трещотка / Держак з тріскотною / Racsnikulcs / Miner de huruitoare / Řehtačka / Račňa prepínacia / Raglja / Terkšle / Reversa atslēga / Pörkratta pide / Трещотка / Račva za nasadni ključ / Račva za gedoru / Καστανιά / Llave de carraca / Nottolino / Catraca de jurar / Clé à cliquet / Rate!

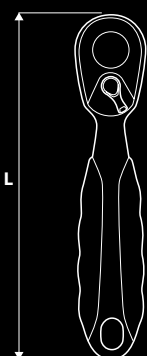

1/4"

DIN  
312225  
years  
guaranteeCrV  
steel

- korpus grzechotki wykonany ze stali CrV
- ratchet body made of CrV steel
- корпус трещотки выполнен из стали CrV
- mechanizm zapadkowy 72 zęby wykonany ze stali CrMo
- ratchet gear 72 teeth made of CrMo steel
- храповик с 72 зубьями, выполнен из стали CrMo

Ref.	L[mm]			EAN
08-501	105	10	60	5907558412185

## Grzechotka

Ratchet handle / Ratsche / Трещотка / Держак з тріскотною / Racsnikulcs / Miner de huruitoare / Řehtačka / Račňa prepínacia / Raglja / Terkšle / Reversa atslēga / Pörkratta pide / Трещотка / Račva za nasadni ključ / Račva za gedoru / Καστανιά / Llave de carraca / Nottolino / Catraca de jurar / Clé à cliquet / Rate!

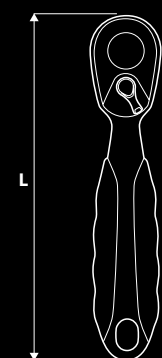

1/4"

CrV  
steel25  
years  
guarantee

- korpus grzechotki wykonany ze stali CrV
- ratchet body made of CrV steel
- корпус трещотки выполнен из стали CrV
- mechanizm zapadkowy 48 zębów wykonany ze stali CrMo
- ratchet gear 48 teeth made of CrMo steel
- храповик с 48 зубьями, выполнен из стали CrMo

Ref.	L[mm]			EAN
08-512	105	10	60	5907558403305

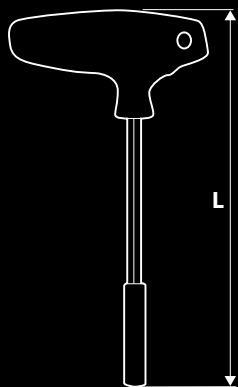

1/4"

CrV  
steel

25  
years  
guarantee

### Uchwyt do końcówek

Bit holder / Aufnahme für Spitzen / Зажим для наконечников / Тримач до наконечників / Hajtószer / Dispozitiv de prinderea capetelor / Skličidlo na nástavce / Uprínadlo na nástavce / Vpenjalo za nastavke / Laikiklis antgaliams / Uzgaļu patrona / Otsakupadrin / Държач за накрайници / Drška za nastavke / Hvat za nastavke / Προσαρμογέας μιλών / Mandril de sujeción para puntas / Portainserti / Suporte de ponteiros / Manche pour embouts / Houder voor eindstukken



Ref.	L[mm]	⊞	⊞	EAN
06-076	175	0	60	5907558411904

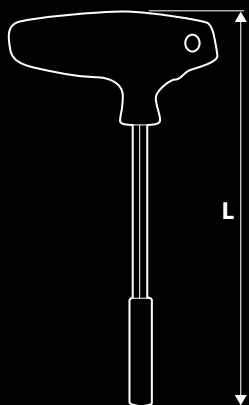

1/4"

CrV  
steel

25  
years  
guarantee

### Uchwyt do końcówek

Bit holder / Aufnahme für Spitzen / Зажим для наконечников / Тримач до наконечників / Hajtószer / Dispozitiv de prinderea capetelor / Skličidlo na nástavce / Uprínadlo na nástavce / Vpenjalo za nastavke / Laikiklis antgaliams / Uzgaļu patrona / Otsakupadrin / Държач за накрайници / Drška za nastavke / Hvat za nastavke / Προσαρμογέας μιλών / Mandril de sujeción para puntas / Portainserti / Suporte de ponteiros / Manche pour embouts / Houder voor eindstukken



Ref.	L[mm]	⊞	⊞	EAN
06-075	175	10	40	5907558410129

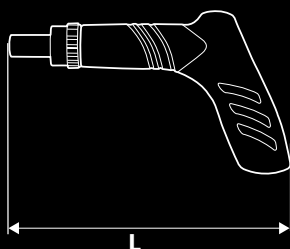

1/4"



S2  
steel

### Uchwyt do bitów z grzechotką

Bit holder / Aufnahme für Spitzen / Зажим для наконечников / Тримач до наконечників / Hajtószer / Dispozitiv de prinderea capetelor / Skličidlo na nástavce / Uprínadlo na nástavce / Vpenjalo za nastavke / Laikiklis antgaliams / Uzgaļu patrona / Otsakupadrin / Държач за накрайници / Drška za nastavke / Hvat za nastavke / Προσαρμογέας μιλών / Mandril de sujeción para puntas / Portainserti / Suporte de ponteiros / Manche pour embouts / Houder voor eindstukken



Ref.	L[mm]	⊞	⊞	EAN
06-077	155	1	50	5907558414400

## Uchwyt do końcówek

Bit holder / Aufnahme für Spitzen / Зажим для наконечников / Тримач до наконечників / Hajtászár / Dispozitiv de prinderea capetelor / Skličadlo na nástavce / Uprinaldo na nástavce / Vpenjalo za nastavke / Laikiklis antgaliams / Uzgaļu patrona / Otsakupadrin / Держач за накрайниці / Drška za nastavke / Hvat za nastavke / Προσαρμογέας μπιτών / Mandril de sujeción para puntas / Portainserți / Suporte de ponteiros / Manche pour embouts / Houder voor eindstukken

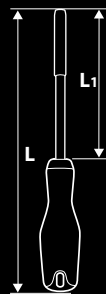

1/4"

CrV  
steel25  
years  
guarantee

Ref.	L[mm]	L1[mm]	☞	☞	EAN
06-078	215	100	12	180	5907558414417

## Końcówki wkrętakowe z uchwytem

Screwdriver bits with holder / Einsätze für Schraubendreher mit Aufnahme / Набор насадок с держателем / Наконечники викруткові, з ручків / Csavarhúzóbetétek tartóval / Set biti cu suport capat / Šroubovákové nástavce s držadlem / Skrutkovacie nástavce s uprinaldom / Nastavki za izvijač z vpenjalom / Atsuktuyo antgalių su laikikliu / Skrūvgrīeža uzgaļu komplekts ar turētāju / Krūvīkeerajaotsakud koos käepidemega / Накрайниці за отвертка с держач / Nastavci za odvijač s hvataljkom / Nastavci za odvijač s drškom / Σετ με κατασφιδύμετες και προσαρμογέα / Puntas destornilladoras con mango / Punte di cacciavite con manico / Ponteiros Chave de fenda com Suporte / Embouts de tournevis de précision avec manche / Schroevendraaiereindstukken met handvat

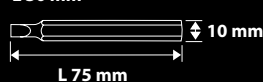
3/8" > 10 mm  
1/2" > 10 mm

x40

1/2"

3/8"

CrV  
steel25  
years  
guarantee

- 7 - końcówki sześciokątne 30 mm: H4, H5, H6, H7, H8, H10, H12
- 7 - końcówki sześciokątne 75 mm: H4, H5, H6, H7, H8, H10, H12
- 7 - końcówki Torx 30 mm: T20, T25, T30, T40, T45, T50, T55
- 7 - końcówki Torx 75 mm: T20, T25, T30, T40, T45, T50, T55
- 5 - końcówki Spline 30 mm: M5, 6, 8, 10, 12
- 5 - końcówki Spline 75 mm: M5, 6, 8, 10, 12
- 1 - uchwyt do końcówek z kwadratem 3/8"
- 1 - uchwyt do końcówek z kwadratem 1/2"
- 7 - hexagonal 30 mm: H4, H5, H6, H7, H8, H10, H12
- 7 - hexagonal 75 mm: H4, H5, H6, H7, H8, H10, H12
- 7 - Torx bits 30 mm: T20, T25, T30, T40, T45, T50, T55
- 7 - Torx bits 75 mm: T20, T25, T30, T40, T45, T50, T55
- 5 - Spline 30 mm: M5, 6, 8, 10, 12
- 5 - Spline 75 mm: M5, 6, 8, 10, 12
- 1 - socket handle 3/8"
- 1 - socket handle 1/2"
- 7 - шестигранных 30 мм: H4, H5, H6, H7, H8, H10, H12
- 7 - шестигранных 75 мм: H4, H5, H6, H7, H8, H10, H12
- 7 - наконечников Torx 30 мм: T20, T25, T30, T40, T45, T50, T55
- 7 - наконечников Torx 75 мм: T20, T25, T30, T40, T45, T50, T55
- 5 - Spline 30 мм: M5, 6, 8, 10, 12
- 5 - Spline 75 мм: M5, 6, 8, 10, 12
- 1 - держатель (патрон) для наконечников с квадратом 3/8"
- 1 - держатель (патрон) для наконечников с квадратом 1/2"

Ref.	☞	☞	EAN
06-107	1	10	5907558414424

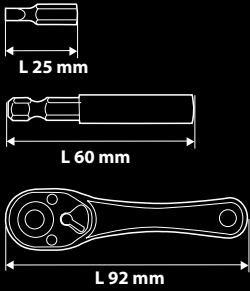

- x38**
- 1/4"**
- 48**
- 
- 
- 
- 
- 
- 
- 
- 
- S2 steel**
- 25 years guarantee**

### Końcówki wkrętakowe z uchwytem

Screwdriver bits with holder / Einsätze für Schraubendreher mit Aufnahme / Набор насадок с держателем / Наконечники викрѣткови, з ручкѣям / Csavarhúzóbetétek tartóval / Set bitii cu suport capat / Šroubovákové nástavce s držadlem / Skrutkovacie nástavce s upínadlom / Nastavki za izvijač z vpenjalom / Atsuktuvo antgaliai su laikikliu / Skrivgrieža uzgaliu komplekts ar turētāju / Krivikeerajaotsakud koos käepidemega / Накрайници за отвертка с държач / Nastavci za odvijač s hvataljkom / Nastavci za odvijač s drškom / Σετ με καταβιδόμενες και προσαρμογέα / Puntas destornilladoras con mango / Punte di cacciavite con manico / Ponteiros Chave de fenda com Suporte / Embouts de tournevis de précision avec manche / Schroevendraaiereindstukken met handvat



- 1 grzechotka
- 1 uchwyt do końcówek 60 mm
- 36 końcówek wkrętakowych 25 mm
- płaskie: 3, 4, 5, 6 mm
- sześciokątne: H2, H2.5, H3, H4, H5, H6
- krzyżowe: PH1x2, PH2x2, PH3x2
- krzyżowe: PZ1x2, PZ2x2, PZ3x3
- Torx: T10, T15, T20, T25, T27, T30, T40
- Torx z otworem: TT10, TT15, TT20, TT25, TT27, TT30, TT40
- ratchet
- bit holder 60 mm
- 36 bits 25 mm
- flat: 3, 4, 5, 6 mm
- hexagonal: H2, H2.5, H3, H4, H5, H6
- cross: PH1x2, PH2x2, PH3x2
- cross: PZ1x2, PZ2x2, PZ3x3
- Torx: T10, T15, T20, T25, T27, T30, T40
- Torx tamperproof TT10, TT15, TT20, TT25, TT27, TT30, TT40
- 1 трещотка
- 1 держатель для наконечников 60 мм
- 36 наконечников 25 мм
- плоские: 3 мм, 4 мм, 5 мм, 6 мм
- шестиугольные: H2, H2.5, H3, H4, H5, H6
- крестовые: PH1x2, PH2x2, PH3x2
- крестовые: PZ1x2, PZ2x2, PZ3x3
- Torx: T10, T15, T20, T25, T27, T30, T40
- Torx с отверстием: TT10, TT15, TT20, TT25, TT27, TT30, TT40

Ref.			EAN
06-105	6	36	5907558402315

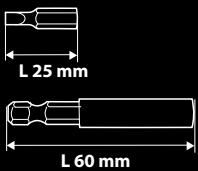

- 
- 
- 
- 
- 
- 1/4"**
- x7**
- 
- 
- S2 steel**
- 25 years guarantee**

### Końcówki wkrętakowe z uchwytem

Screwdriver bits with holder / Einsätze für Schraubendreher mit Aufnahme / Набор насадок с держателем / Наконечники викрѣткови, з ручкѣям / Csavarhúzóbetétek tartóval / Set bitii cu suport capat / Šroubovákové nástavce s držadlem / Skrutkovacie nástavce s upínadlom / Nastavki za izvijač z vpenjalom / Atsuktuvo antgaliai su laikikliu / Skrivgrieža uzgaliu komplekts ar turētāju / Krivikeerajaotsakud koos käepidemega / Накрайници за отвертка с държач / Nastavci za odvijač s hvataljkom / Nastavci za odvijač s drškom / Σετ με καταβιδόμενες και προσαρμογέα / Puntas destornilladoras con mango / Punte di cacciavite con manico / Ponteiros Chave de fenda com Suporte / Embouts de tournevis de précision avec manche / Schroevendraaiereindstukken met handvat



- 1 uchwyt do końcówek 60 mm
- 6 końcówek wkrętakowych 25 mm
- płaskie : 4,5, 6 mm
- krzyżowe : PH1, PH2
- Torx: T15, T20
- 1 bit holder, 60mm
- 6 driver bits, 25mm
- slotted bits: 4,5, 6 mm
- cross slotted bits: PH1, PH2
- Torx: T15, T20
- 1 держатель для насадок 60 мм
- 6 насадок 25 мм
- шлицевые: 4,5, 6 мм
- шестигранные: PH1, PH2
- Torx: T15, T20

Ref.			EAN
06-101	12	120	5907558402339

### Końcówki wkrętakowe z uchwytem

Screwdriver bits with holder / Einsätze für Schraubendreher mit Aufnahme / Набор насадок с держателем / Наконечники викрёткові, з ручками / Csavarhúzóbetétek tartóval / Set biti cu suport capat / Šroubovákové nástavce s držadlem / Skrutkovacie nástavce s upínadlom / Nastavki za izvijač z vpenjalom / Atsuktuvo antgaliai su laikikliu / Skrūvgręžia uzgaliu komplekts ar turētāju / Krūviķeeraļsatsakud koos kāberidmega / Накрайниці за отвертка з держач / Nastavci za odvijač s hvataljkom / Nastavci za odvijač s drškom / Σετ με καταβιδόμενες και προσαρμογέα / Puntas destornilladoras con mango / Punte di cacciavite con manico / Ponteiros Chave de fenda com Suporte / Embouts de tournevis de précision avec manche / Schroevendraaiereindstukken met handvat

L 25 mm  
L 65 mm

1/4"

x11

SUPER HARD S2 steel

25 years guarantee

25mm



- 1 uchwyt do końcówek 60 mm
- 10 końcówek wkrętakowych 25 mm
- płaskie : 4.5, 5.5 mm
- krzyżowe : PH1, PH2, PZ1, PZ2
- Torx: T20, T25
- sześciokątne: H3, H5
- 1 bit holder, 60mm
- 10 driver bits, 25mm
- slotted bits: 4.5, 5.5 mm
- cross slotted bits: PH1, PH2, PZ1, PZ2
- Torx: T20, T25
- hexagonal bits: H3, H5
- 1 держатель для насадок 60 мм
- 10 насадок 25 мм
- шлицевые: 4.5, 5.5 мм
- Phillips: PH1, PH2, PZ1, PZ2
- Торх: Т20, Т25
- шестигранные: H3, H5

Ref.	📦	📦	EAN
06-102	24	96	5907558410136



### Końcówki wkrętakowe z uchwytem

Screwdriver bits with holder / Einsätze für Schraubendreher mit Aufnahme / Набор насадок с держателем / Наконечники викрёткові, з ручками / Csavarhúzóbetétek tartóval / Set biti cu suport capat / Šroubovákové nástavce s držadlem / Skrutkovacie nástavce s upínadlom / Nastavki za izvijač z vpenjalom / Atsuktuvo antgaliai su laikikliu / Skrūvgręžia uzgaliu komplekts ar turētāju / Krūviķeeraļsatsakud koos kāberidmega / Накрайниці за отвертка з держач / Nastavci za odvijač s hvataljkom / Nastavci za odvijač s drškom / Σετ με καταβιδόμενες και προσαρμογέα / Puntas destornilladoras con mango / Punte di cacciavite con manico / Ponteiros Chave de fenda com Suporte / Embouts de tournevis de précision avec manche / Schroevendraaiereindstukken met handvat

L 25 mm  
L 60 mm  
L 50 mm

1/4"

x99

SUPER HARD S2 steel

25 years guarantee



- końcówki 25 mm
- 8 – płaskie : 3, 4, 4.5, 5.5, 6, 6.5, 7, 8 mm
- 9 – krzyżowe: PH0, PH1, PH2x5, PH3
- 9 – krzyżowe: PZ0, PZ1x2, PZ2x5, PZ3
- 9 – sześciokątne : H1.5, H2, H2.5, H3, H4, H5, H5.5, H6, H8
- 10 – sześciokątne calowe: H1/16, H5/64, H3/32, H7/64, H1/8, H9/64, H5/32, H3/16, H7/32, H1/4"
- 3 – Spline – M5, M6, M8
- 9 – Torx T8, T10, T15, T20, T25, T27, T30, T40, T45
- 9 – Torx z otworem: TT8, TT10, TT15, TT20, TT25, TT27, TT30, TT35, TT40
- 6 – sześciokątne z otworem calowe: 5/64, 3/32, 7/64, 1/8, 9/64, 5/32"
- 6 – sześciokątne z otworem: HT2, HT2.5, HT3, HT4, HT5, HT6
- 4 – kwadrat: No0, No1, No2, No3
- 4 – serwisowy: 6, 8, 10 mm
- 3 – trzyskrzydłowy: 2, 3, 4 mm
- 3 – dwuskrzydłowy: 1, 2, 3 mm
- 4 – czteroskrzydłowy: 4, 6, 8, 10 mm
- uchwyt magnetyczny: 60 mm
- adapter do nasadek: 50 mm
- adapter do nasadek: 25 mm
- adapter do końcówek
- uchwyt do haków
- bits 25 mm
- 8 – flat: 3, 4, 4.5, 5.5, 6, 6.5, 7, 8 mm
- 9 – cross: PH0, PH1, PH2x5, PH3
- 9 – cross: PZ0, PZ1x2, PZ2x5, PZ3
- 9 – hexagonal: H1.5, H2, H2.5, H3, H4, H5, H5.5, H6, H8
- 10 – hexagonal (imperial): H1/16, H5/64, H3/32, H7/64, H1/8, H9/64, H5/32, H3/16, H7/32, H1/4"
- 3 – Spline: M5, M6, M8
- 9 – Torx: T8, T10, T15, T20, T25, T27, T30, T40, T45
- 9 – Torx tamperproof: TT8, TT10, TT15, TT20, TT25, TT27, TT30, TT35, TT40
- 6 – hexagonal tamperproof (imperial): 5/64, 3/32, 7/64, 1/8, 9/64, 5/32"
- 6 – hexagonal tamperproof: HT2, HT2.5, HT3, HT4, HT5, HT6
- 4 – square: No0, No1, No2, No3
- 4 – service: 6, 8, 10 mm
- 3 – tri-wing: 2, 3, 4 mm
- 3 – bi-wing: 1, 2, 3 mm
- 4 – torq-set: 4, 6, 8, 10 mm
- magnetic holder 60 mm
- socket adapter 50 mm
- socket adapter 25 mm
- bit adapter
- hook holder
- наконечники: 25 мм
- 8 – шлицевые: 3, 4, 4.5, 5.5, 6, 6.5, 7, 8 мм
- 9 – крестовых: PH0, PH1, PH2x5, PH3
- 9 – крестовых: PZ0, PZ1x2, PZ2x5, PZ3
- 9 – шестигранных: H1.5, H2, H2.5, H3, H4, H5, H5.5, H6, H8
- 10 – шестигранных дюймовых H1/16, H5/64, H3/32, H7/64, H1/8, H9/64, H5/32, H3/16, H7/32, H1/4"
- 3 – Spline M5, M6, M8
- 9 – Torx T8, T10, T15, T20, T25, T27, T30, T40, T45
- 9 – Торх с отверстием: TT8, TT10, TT15, TT20, TT25, TT27, TT30, TT35, TT40
- 6 – шестигранных с отверстием, дюймовых: 5/64, 3/32, 7/64, 1/8, 9/64, 5/32"
- 6 – шестигранных с отверстием HT2, HT2.5, HT3, HT4, HT5, HT6
- 4 – квадрата: No0, No1, No2, No3
- 4 – с двумя выступами: 6, 8, 10 мм
- 3 – трехрыльных: 2, 3, 4 мм
- 3 – двухрыльных: 1, 2, 3 мм
- 4 – четырехрыльных 4, 6, 8, 10 мм
- магнитный держатель 60 мм
- адаптер для торцевых головок 50 мм
- адаптер для торцевых головок 25 мм
- адаптер для наконечников
- держатель для ввинчивания крюков

Ref.	📦	📦	EAN
06-104	6	24	5907558406245



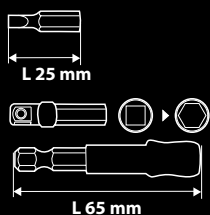

SUPER HARD  
**S2**  
steel

**25**  
years  
guarantee



### Końcówki wkrętakowe z uchwytem

Screwdriver bits with holder / Einsätze für Schraubendreher mit Aufnahme / Набор насадок с держателем / Наконечники викрутковой, зручкыям / Csavarhúzóbetétek tartóval / Set biti cu suport capat / Šroubovákové nástavce s držadlem / Skrutkovacie nástavce s upínadlom / Nastavki za izvijač z vpenjalom / Atsuktuvo antgaliai su laikikliu / Skruvgrieža uzgāļu komplekts ar turētāju / Krutvikeraajatsakud koos käepidemega / Накрайники за отвертка с держач / Nastavci za odvijač s hvataljkom / Nastavci za odvijač s drškom / Σετ με καταβιδώμετες και προσαρμογέα / Puntas destornilladoras con mango / Punte di cacciavite con manico / Ponteiras Chave de fenda com Suporte / Embouts de tournevis de précision avec manche / Schroevendraaiereindstukken met handvat



- 1 uchwyt do końcówek 65 mm
- 30 końcówek wkrętakowych 25 mm
- płaskie : 3, 4, 5, 6 mm
- krzyżowe : PH1, 2xPH2, PH3, PZ1, 2xPZ2, PZ3
- Torx: T10, T15, T20, T25, T27, T30, T40
- Torx z otworem : TT10, TT15, TT20, TT25, TT27, TT30, TT40
- sześciokątne : H3, H4, H5, H6
- adapter do nasadek 1/4"

- 1 bit holder 65 mm
- 30 driver bits, 25 mm
- slotted bits : 3, 4, 5, 6 mm
- cross slotted bits : PH1, 2xPH2, PH3, PZ1, 2xPZ2, PZ3
- Torx: T10, T15, T20, T25, T27, T30, T40
- Torx tamperproof bits : TT10, TT15, TT20, TT25, TT27, TT30, TT40
- hexagonal bits : H3, H4, H5, H6
- socket adaptor 1/4"

- 1 держатель для насадок 65 мм
- 30 насадок 25 мм
- шлицевые : 3, 4, 5, 6 мм
- Phillips: PH1, 2xPH2, PH3, PZ1, 2xPZ2, PZ3
- Torx: T10, T15, T20, T25, T27, T30, T40
- Torx с отверстием: TT10, TT15, TT20, TT25, TT27, TT30, TT40
- шестигранные: H3, H4, H5, H6
- переходник для торцевых головок 1/4"

Ref.	📦	📦	EAN
06-106	12	48	5907558410143

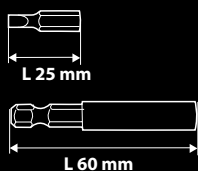

SUPER HARD  
**S2**  
steel

**25**  
years  
guarantee



### Końcówki wkrętakowe z uchwytem

Screwdriver bits with holder / Einsätze für Schraubendreher mit Aufnahme / Набор насадок с держателем / Наконечники викрутковой, зручкыям / Csavarhúzóbetétek tartóval / Set biti cu suport capat / Šroubovákové nástavce s držadlem / Skrutkovacie nástavce s upínadlom / Nastavki za izvijač z vpenjalom / Atsuktuvo antgaliai su laikikliu / Skruvgrieža uzgāļu komplekts ar turētāju / Krutvikeraajatsakud koos käepidemega / Накрайники за отвертка с держач / Nastavci za odvijač s hvataljkom / Nastavci za odvijač s drškom / Σετ με καταβιδώμετες και προσαρμογέα / Puntas destornilladoras con mango / Punte di cacciavite con manico / Ponteiras Chave de fenda com Suporte / Embouts de tournevis de précision avec manche / Schroevendraaiereindstukken met handvat



- uchwyt do końcówek 60 mm
- 30 końcówek wkrętakowych 25 mm
- płaskie : 3, 4, 5, 6 mm
- krzyżowe : PH1, 2xPH2, PH3, PZ1, 2xPZ2, PZ3
- Torx: T10, T15, T20, T25, T27, T30, T40
- Torx z otworem : TT10, TT15, TT20, TT25, TT27, TT30, TT40
- sześciokątne : H3, H4, H5, H6 mm

- 1 bit holder 60 mm
- 30 driver bits, 25 mm
- slotted bits : 3, 4, 5, 6 mm
- cross slotted bits : PH1, 2xPH2, PH3, PZ1, 2xPZ2, PZ3
- Torx: T10, T15, T20, T25, T27, T30, T40
- Torx tamperproof bits : TT10, TT15, TT20, TT25, TT27, TT30, TT40
- hexagonal bits : H3, H4, H5, H6 mm

- 1 держатель для насадок 60 мм
- 30 насадок 25 мм
- шлицевые : 3, 4, 5, 6 мм
- Phillips: PH1, 2xPH2, PH3, PZ1, 2xPZ2, PZ3
- Torx: T10, T15, T20, T25, T27, T30, T40
- Torx с отверстием: TT10, TT15, TT20, TT25, TT27, TT30, TT40
- шестигранные: H3, H4, H5, H6 мм

Ref.	📦	📦	EAN
06-103	6	24	5907558402346

10 mm  
L 30 mm

10 mm  
L 75 mm

10 mm  
L 120 mm

L - 135 mm



## Końcówki wkrętakowe z grzechotką

Driver bits / Einsätze für Schraubendreher / Насадки / Наконечники викрутки / Csavarhúzó betétek / Set biti / Šroubovákové nástavce / Skrutkovacie nástavce / Nastavki za izvijače / Atsuktuvo antgaliai / Skrivgriēja uzgali / Krivikeerajaotsakud / Накрайници за отвертка / Nastavci za odvijač / Nastavci za odvijač / Καταβιδόμενες / Puntas destornilladoras / Punte di cacciavite con noddolino / Ponteiros de Chave de fenda com catraca de furar / Embouts de tournevis à cliquet / Eendstukken voor schroevendraaiers met ratel



- 1 – grzechotka 72 zęby do końcówek 10 mm - 135 mm
- 21 – końcówek 10 x 30 mm
- końcówki krzyżowe: PH2, 3
- sześciokątne: H4, H5, H6, H8, H10, H12
- Torx z otworem: TT20, TT25, TT30, TT40, TT45, TT50, TT55, TT60
- Spline: M5, 6, 8, 10, 12
- 12 – końcówek 10 x 75 mm
- sześciokątne: 5, 6, 7, 8, 10 mm
- Torx: T25, T27, T30, T40, T45, T50, T55
- 3 końcówki 10 x 120 mm - T45, T50, T55

- 1 – ratchet, 72 teeth for 10 mm bits 10 mm - 135 mm
- 21 bits 10 x 30 mm
- cross slotted bits: PH2, 3
- hexagonal: H4, H5, H6, H8, H10, H12
- Torx tamperproof: TT20, TT25, TT30, TT40, TT45, TT50, TT55, TT60
- Spline: M5, 6, 8, 10, 12
- 12 – bits 10 x 75 mm
- hexagonal: 5, 6, 7, 8, 10 mm
- Torx: T25, T27, T30, T40, T45, T50, T55
- 3 bits: 10 x 120 mm - T45, T50, T55

- трещотка 72 зуба для наконечников 10 мм - 135 мм
- 21 – наконечник 10 x 30 мм
- Phillips: PH2, 3
- шестигранные: H4, H5, H6, H8, H10, H12
- Torx с отверстием: TT20, TT25, TT30, TT40, TT45, TT50, TT55, TT60
- Spline: M5, 6, 8, 10, 12
- наконечников 10 x 75 мм
- шестигранные: 5, 6, 7, 8, 10 мм
- Torx: T25, T27, T30, T40, T45, T50, T55
- наконечника 10 x 120 мм - T45, T50, T55

Ref.	m[kg]	☞	☞	EAN
08-701	1,9	0	8	5907558402742

10 mm  
L 30 mm

3/8" ▶ 10 mm  
1/2" ▶ 10 mm

L 30 mm



## Końcówki wkrętakowe z uchwytem

Driver bits / Einsätze für Schraubendreher / Насадки / Наконечники викрутки / Csavarhúzó betétek / Set biti / Šroubovákové nástavce / Skrutkovacie nástavce / Nastavki za izvijače / Atsuktuvo antgaliai / Skrivgriēja uzgali / Krivikeerajaotsakud / Накрайници за отвертка / Nastavci za odvijač / Nastavci za odvijač / Καταβιδόμενες / Puntas destornilladoras / Punte di cacciavite con manico / Ponteiros Chave de fenda com Suporte / Embouts de tournevis de précision avec manche / Schroevendraaiereendstukken met handvat



- 10 – końcówek Ribe 30 mm: RM4, RM5, RM6, RM7, RM8, RM9, RM10, RM12, RM13, RM14
- 10 – końcówek Torx 30 mm: T10, T15, T20, T25, T27, T30, T40, T45, T50, T55
- 5 – końcówek Spline 30 mm: M4, 5, 6, 8, 10, 12
- 6 – końcówek sześciokątnych 30 mm: H4, H5, H6, H8, H10, H12
- 2 – końcówki płaskie: 8, 10 mm
- 3 – końcówki krzyżowe: PH1, PH2, PH3
- magnetyczny uchwyt do końcówek 10 mm, długość 90 mm
- uchwyt do końcówek z kwadratem 3/8"
- uchwyt do końcówek 1/2"

- 10 – Ribe bits 30 mm: RM4, RM5, RM6, RM7, RM8, RM9, RM10, RM12, RM13, RM14
- 10 – Torx bits 30 mm: T10, T15, T20, T25, T27, T30, T40, T45, T50, T55
- 5 – Spline bits 30 mm: M4, 5, 6, 8, 10, 12
- 6 – hexagonal 30 mm: H4, H5, H6, H8, H10, H12
- 2 – flat 30 mm: 8, 10 mm
- 3 – cross Phillips 30 mm: PH1, PH2, PH3
- magnetic bits holder 10 mm, length 90 mm
- socket handle 3/8"
- bit holder 1/2"

- 10 – наконечников Ribe 30 мм: RM4, RM5, RM6, RM7, RM8, RM9, RM10, RM12, RM13, RM14
- 10 – наконечников Torx 30 мм: T10, T15, T20, T25, T27, T30, T40, T45, T50, T55
- 5 – наконечников Spline 30 мм: M4, 5, 6, 8, 10, 12
- 6 – шестигранные 30 мм: H4, H5, H6, H8, H10, H12
- 2 – плоские 30 мм: 8, 10 мм
- 3 – крестовые Phillips 30 мм: PH1, PH2, PH3
- магнитный патрон для наконечников 10 мм, длина 90 мм
- держатель (патрон) для наконечников с квадратом 3/8"
- держатель для наконечников 1/2"

Ref.	m[kg]	☞	☞	EAN
08-702	1,0	5	10	5907558405392

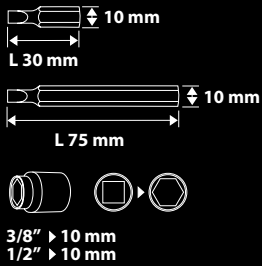

x22

SUPER HARD  
S2  
steel

25  
years  
guarantee

### Końcówki wkrętaskowe

Driver bits / Einsätze für Schraubendreher / Насадки / Наконечники викрүтові / Csavarhúzó betétek / Set biti / Šroubovákové nástavce / Skrutkovacie nástavce / Nastavki za izvijače / Atsuktuno antgaliai / Skruvgrieða uzgāļi / Kruvikeerajaotsakud / Накрайници за отвертка / Nastavci za odvijač / Nastavci za odvijač / Καταβιδόμετες / Puntas destornilladoras / Punte per cacciaviti / Ponteiros de chave de fenda / Embouts de tournevis / Schroevendraaiereindstukken



- końcówki serwisowe do samochodów marki: Fiat, Alfa Romeo
- 10 – końcówek Ribe 30 mm: RM4, RM5, RM6, RM7, RM8, RM9, RM10, RM12, RM13, RM14
- 10 – końcówek Ribe 75 mm: RM4, RM5, RM6, RM7, RM8, RM9, RM10, RM12, RM13, RM14
- 1 – uchwyt do końcówek z kwadratem 3/8"
- 1 – uchwyt do końcówek z kwadratem 1/2"

- service bits for cars brands: Fiat, Alfa Romeo
- 10 – Ribe bits 30 mm: RM4, RM5, RM6, RM7, RM8, RM9, RM10, RM12, RM13, RM14
- 10 – Ribe bits 75 mm: RM4, RM5, RM6, RM7, RM8, RM9, RM10, RM12, RM13, RM14
- 1 – socket handle 3/8"
- 1 – socket handle 1/2"

- сервисные наконечники для автомобилей марки: Fiat, Alfa Romeo
- 10 – наконечников Ribe 30 mm: RM4, RM5, RM6, RM7, RM8, RM9, RM10, RM12, RM13, RM14
- 10 – наконечников Ribe 75 mm: RM4, RM5, RM6, RM7, RM8, RM9, RM10, RM12, RM13, RM14
- 1 – держатель (патрон) для наконечников с квадратом 3/8"
- 1 – держатель (патрон) для наконечников с квадратом 1/2"

Ref.	m[kg]	📦	📦	EAN
08-703	1,0	5	10	5907558405408

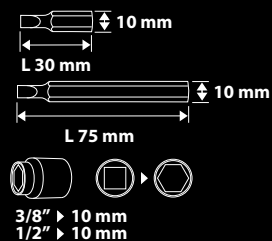

x22

SUPER HARD  
S2  
steel

25  
years  
guarantee

### Końcówki wkrętaskowe

Driver bits / Einsätze für Schraubendreher / Насадки / Наконечники викрүтові / Csavarhúzó betétek / Set biti / Šroubovákové nástavce / Skrutkovacie nástavce / Nastavki za izvijače / Atsuktuno antgaliai / Skruvgrieða uzgāļi / Kruvikeerajaotsakud / Накрайници за отвертка / Nastavci za odvijač / Nastavci za odvijač / Καταβιδόμετες / Puntas destornilladoras / Punte per cacciaviti / Ponteiros de chave de fenda / Embouts de tournevis / Schroevendraaiereindstukken



- 10 – końcówek Torx 30 mm: T10, T15, T20, T25, T27, T30, T40, T45, T50, T55
- 10 – końcówek Torx 75 mm: T10, T15, T20, T25, T27, T30, T40, T45, T50, T55
- 1 – uchwyt do końcówek z kwadratem 3/8"
- 1 – uchwyt do końcówek z kwadratem 1/2"

- Torx bits 30 mm: T10, T15, T20, T25, T27, T30, T40, T45, T50, T55
- Torx bits 75 mm: T10, T15, T20, T25, T27, T30, T40, T45, T50, T55
- 1 – socket handle 3/8"
- 1 – socket handle 1/2"

- 10 наконечников Torx 30 мм: T10, T15, T20, T25, T27, T30, T40, T45, T50, T55
- 10 наконечников Torx 75 мм: T10, T15, T20, T25, T27, T30, T40, T45, T50, T55
- 1 – держатель (патрон) для наконечников с квадратом 3/8"
- 1 – держатель (патрон) для наконечников с квадратом 1/2"

Ref.	m[kg]	📦	📦	EAN
08-704	1,0	5	10	5907558405415