



Łączące
Joining
Соединительные



TOPEX

ZSZYWACZ

Stapler / Heftmaschine / Cmennep / Cmennep / Túzógép / Capsator / Sešivačka / Zošivačka / Spenjač / Kabiamušis / Skavu pistole / Klammerdaja / Подлишач / Klamerica / Heftalica / Μηχανή συρραφής / Grapadora / Cucitrice / Máquina de pontear / Agrafeuse / Hechtmachine

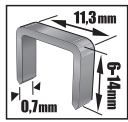

typ J



Ref.	☒	EAN
41E906	20/40	5902062031594

ZSZYWACZ

Stapler / Heftmaschine / Cmennep / Cmennep / Túzógép / Capsator / Sešivačka / Zošivačka / Spenjač / Kabiamušis / Skavu pistole / Klammerdaja / Подлишач / Klamerica / Heftalica / Μηχανή συρραφής / Grapadora / Cucitrice / Máquina de pontear / Agrafeuse / Hechtmachine

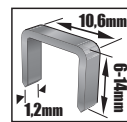

typ G



Ref.	☒	EAN
41E908	0/40	5902062419088

ZSZYWACZ

Stapler / Heftmaschine / Cmennep / Cmennep / Túzógép / Capsator / Sešivačka / Zošivačka / Spenjač / Kabiamušis / Skavu pistole / Klammerdaja / Подлишач / Klamerica / Heftalica / Μηχανή συρραφής / Grapadora / Cucitrice / Máquina de pontear / Agrafeuse / Hechtmachine

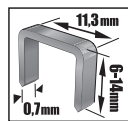

typ J



Ref.	☒	EAN
41E905	20/40	5902062030634

ZSZYWACZ

Stapler / Heftmaschine / Cmennep / Cmennep / Túzógép / Capsator / Sešivačka / Zošivačka / Spenjač / Kabiamušis / Skavu pistole / Klammerdaja / Подлишач / Klamerica / Heftalica / Μηχανή συρραφής / Grapadora / Cucitrice / Máquina de pontear / Agrafeuse / Hechtmachine

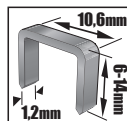

typ G

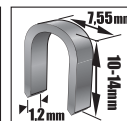

typ L

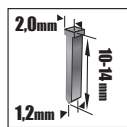

typ E



Ref.	☒	EAN
41E910	10/20	5902062419101

ZSZYWACZ

Stapler / Heftmaschine / Cmennep / Cmennep / Túzógép / Capsator / Sešivačka / Zošivačka / Spenjač / Kabiamušis / Skavu pistole / Klammerdaja / Подлишач / Klamerica / Heftalica / Μηχανή συρραφής / Grapadora / Cucitrice / Máquina de pontear / Agrafeuse / Hechtmachine

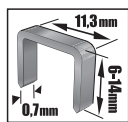

typ J



Ref.	☒	EAN
41E903	20/40	5902062030580

ZSZYWKI

Staples / Klammern / Снобы / Сноби / Túzókarocs / capsator / Sešivací spony / Sponky / Sponke / Kabes / Skavas / Klambri / Телчета / Municia za klamericu / Heftalica / Συρραπτήρες / Grapas / Punti metallici / Pontas / Agrafes / Hechters

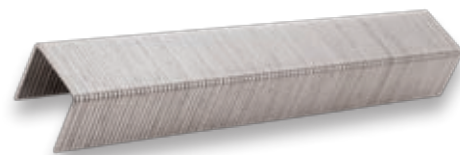
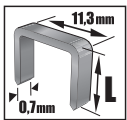

Ref.	L [mm]	N	☒	EAN
41E306	6	x1000	20/200	5902062030436
41E308	8	x1000	20/200	5902062030443
41E310	10	x1000	20/200	5902062202499
41E312	12	x1000	20/200	5902062202772
41E314	14	x1000	20/200	5902062202505

Zszywki

Staples / Klammern / Сшобы / Сшоби / Tűzőkapocs / Capsator / Sešivací spony / Sponky / Sponke / Kabès / Skavas / Klambrid / Τελμετα / Municija za klamericu / Heftalica / Συρραπίδες / Grapas / Punti metallici / Pontas / Agrafes / Hechters

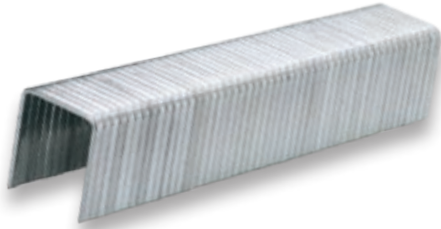
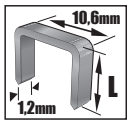

G/11

Ref.	L [mm]	N	☒	EAN
41E406	6	x1000	0/200	5902062414069
41E408	8	x1000	0/200	5902062414083
41E410	10	x1000	0/100	5902062414106
41E412	12	x1000	0/100	5902062414120
41E414	14	x1000	0/100	5902062414144

Zszywki

NARZĘDZIA RĘCZNE / ŁĄCZĄCE

Staples / Klammern / Сшобы / Сшоби / Tűzőkapocs / Capsator / Sešivací spony / Sponky / Sponke / Kabès / Skavas / Klambrid / Τελμετα / Municija za klamericu / Heftalica / Συρραπίδες / Grapas / Punti metallici / Pontas / Agrafes / Hechters

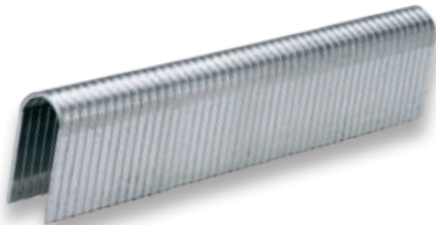
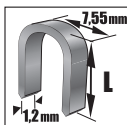

L

Ref.	L [mm]	N	☒	EAN
41E441	10	x1000	0/100	5902062414410
41E442	12	x1000	0/100	5902062414427
41E443	14	x1000	0/100	5902062414434

Gwoździe

Nails / Nägel / Γвозди / Цвяжы / Tűzőgépszeg / Cuie / Hřebíky / Klinec / Žblji / Vinyis / Naglas / Naelad / Пирони за такер / Čavličci za pneuatsku klamericu / Municija za heftalicu / Καρφιά / Clavos / Punti metallici / Pontas / Agrafes / Spijkers

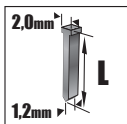

E

Ref.	L [mm]	N	☒	EAN
41E421	10	x1000	0/200	5902062414212
41E423	14	x1000	0/200	5902062414236

PISTOLET KLEJOWY

Glue gun / Leimpistole / Пистолет клеєвої / Πιστολετ κλεΐουοϋ / Ragasztópisztoly / Pistol de lipit / Lepící pistole / Pištol lepiaca / Lepilna pištola / Kljij pistoletas / Limes pistole / Liimpüstol / Пистолет за сипљон / Pištolj za plastiku / Pistolj za plastiku / Πιστόλι θερμοκόλλησης / Pistola surtidora de pegamento / Pistola incollante / Pistola p. Cola / Pistolet à colle / Lijmpistool



180
P_{max}[W]

11,2
Ø [mm]



Ref.	P [W]	q [g/min]	☒	EAN
42E502	30/180	26-30	6/12	5902062130396

PISTOLET KLEJOWY

Glue gun / Leimpistole / Пистолет клеєвої / Πιστολετ κλεΐουοϋ / Ragasztópisztoly / Pistol de lipit / Lepící pistole / Pištol lepiaca / Lepilna pištola / Kljij pistoletas / Limes pistole / Liimpüstol / Пистолет за сипљон / Pištolj za plastiku / Pistolj za plastiku / Πιστόλι θερμοκόλλησης / Pistola surtidora de pegamento / Pistola incollante / Pistola p. Cola / Pistolet à colle / Lijmpistool



80
P_{max}[W]

11,2
Ø [mm]



Ref.	P [W]	q [g/min]	☒	EAN
42E511	15/80	14-16	0/12	5902062425119

PISTOLET KLEJOWY

Glue gun / Leimpistole / Пистолет клеєвої / Πιστολετ κλεΐουοϋ / Ragasztópisztoly / Pistol de lipit / Lepící pistole / Pištol lepiaca / Lepilna pištola / Kljij pistoletas / Limes pistole / Liimpüstol / Пистолет за сипљон / Pištolj za plastiku / Pistolj za plastiku / Πιστόλι θερμοκόλλησης / Pistola surtidora de pegamento / Pistola incollante / Pistola p. Cola / Pistolet à colle / Lijmpistool



200
P_{max}[W]

11,2
Ø [mm]



Ref.	P [W]	q [g/min]	☒	EAN
42E521	20/200	12	12/48	5902062425218

PISTOLET KLEJOWY

Glue gun / Leimpistole / Пистолет клеевой / Πιστολετ κλεϊούσι / Ragasztópisztoly / Pistol de lipit / Lepící pistole / Pištol lepiaca / Lepilna pištola / Ključ pistoletas / Limes pistole / Liimipistol / Пистолет за силикон / Pištolj za plastiku / Pistolj za plastiku / Πιστόλι θερμοκόλλησης / Pistola surtidora de pegamento / Pistola incollante / Pistola p. Cola / Pistolet à colle / Lijmpistol



200
P_{max}[W]
11,2
Ø [mm]
CE

Ref.	P [W]	q [g/min]	⊠	EAN
42E522	20/200	15	12/48	5902062425225

PISTOLET KLEJOWY

Glue gun / Leimpistole / Пистолет клеевой / Πιστολετ κλεϊούσι / Ragasztópisztoly / Pistol de lipit / Lepící pistole / Pištol lepiaca / Lepilna pištola / Ključ pistoletas / Limes pistole / Liimipistol / Пистолет за силикон / Pištolj za plastiku / Pistolj za plastiku / Πιστόλι θερμοκόλλησης / Pistola surtidora de pegamento / Pistola incollante / Pistola p. Cola / Pistolet à colle / Lijmpistol



78
P_{max}[W]
11,2
Ø [mm]
CE

Ref.	P [W]	q [g/min]	⊠	EAN
42E501	25/78	12-18	10/40	5902062091130

WKŁADY KLEJOWE

Glue sticks / Leimpatronen / Стержни клеевые / Στριχσί κλεϊούσι / Ragasztópátron / Mandrină de lipit / Ту́чки лепидла / Ту́чки лепiace / Lepilo v palicah / Ključ lazdelės / Limes stobriņi / Liimipulgad / Силикон на пръчки / PVC štariči / PVC starici / Φυσίγια θερμοκόλλησης / Cartuchos de pegamento / Inserti di colla / Cartuchos de cola / Cartouches de colle / Lijmstift

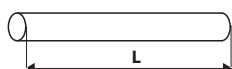

Ref.	Ø [mm]	L [mm]	N	kolor	kg	⊠	EAN
42E113	11,2	250	x12	⊠	0,300	0/50	5902062130402
42E171	11,2	250	x12	⊠	0,300	10/50	5902062130419
42E172	11,2	250	x12	⊠	0,300	10/50	5902062130426
42E173	11,2	250	x12	⊠	0,300	10/50	5902062130433

WKŁADY KLEJOWE

Glue sticks / Leimpatronen / Стержни клеевые / Στριχσί κλεϊούσι / Ragasztópátron / Mandrină de lipit / Ту́чки лепидла / Ту́чки лепiace / Lepilo v palicah / Ključ lazdelės / Limes stobriņi / Liimipulgad / Силикон на пръчки / PVC štariči / PVC starici / Φυσίγια θερμοκόλλησης / Cartuchos de pegamento / Inserti di colla / Cartuchos de cola / Cartouches de colle / Lijmstift

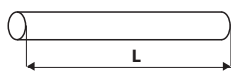

Ref.	Ø [mm]	L [mm]	N	kolor	kg	⊠	EAN
42E154	11,2	300	x65	⊠	2	0/5	5902062421548
42E155	11,2	300	x167	⊠	5	0/1	5902062130600

NITOWNICA

Riveter / Nietmaschine / Заклепочник / Клепальний інструмент / Popszegecsűző / Maşină de nituit / Nýtovačka / Nitovacie kliešte / Kovičar / Kniediklis / Kniežu stangas / Needitangid / Нитачка / Kliešta za zakovice / Pistolj za por nitne / Πριτωναδόρος / Remachadora para remaches de acero y aluminio / Chiodatrice / Rebitadora / Riveuse / Klinknagelmachine

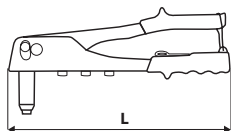

AL 2,4 3,2 4,0 4,8
Ø [mm] Ø [mm] Ø [mm] Ø [mm]



Ref.	L [mm]	⊠	EAN
43E707	250	10/40	5902062020666

NITOWNICA

Riveter / Nietmaschine / Заклепочник / Клепальний інструмент / Popszegecsűző / Maşină de nituit / Nýtovačka / Nitovacie kliešte / Kovičar / Kniediklis / Kniežu stangas / Needitangid / Нитачка / Kliešta za zakovice / Pistolj za por nitne / Πριτωναδόρος / Remachadora para remaches de acero y aluminio / Chiodatrice / Rebitadora / Riveuse / Klinknagelmachine

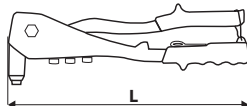

AL 2,4 3,2 4,0 4,8
Ø [mm] Ø [mm] Ø [mm] Ø [mm]



Ref.	L [mm]	⊠	EAN
43E701	260	0/24	5902062020079

NITOWNICA

Riveter / Nietmaschine / Заклепочник / Клепальный инструмент / Popszegecszűzó / Mašinã de nituit / Nýtovačka / Nitovacie kliešte / Kovičar / Kniediklis / Kniežu stangas / Needitangid / Нутачна / Klijesta za zakovice / Pistolj za pop nitne / Пританаборос / Remachadora para remaches de acero y aluminio / Chiodatrice / Rebitadora / Riveuse / Klinknagelmachine

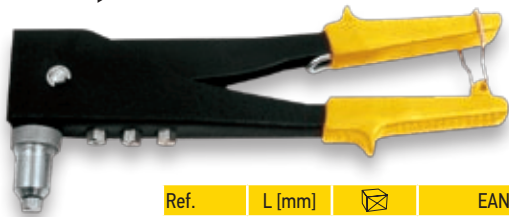
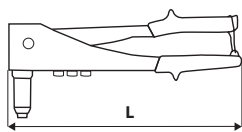

Ref.	L [mm]	☒	EAN
43E712	270	0/24	5902062020260

NITOWNICA

Riveter / Nietmaschine / Заклепочник / Клепальный инструмент / Popszegecszűzó / Mašinã de nituit / Nýtovačka / Nitovacie kliešte / Kovičar / Kniediklis / Kniežu stangas / Needitangid / Нутачна / Klijesta za zakovice / Pistolj za pop nitne / Пританаборос / Remachadora para remaches de acero y aluminio / Chiodatrice / Rebitadora / Riveuse / Klinknagelmachine

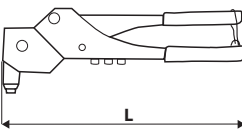

Ref.	L [mm]	☒	EAN
43E713	300	0/24	5902062020246

NITOWNICA

Riveter / Nietmaschine / Заклепочник / Клепальный инструмент / Popszegecszűzó / Mašinã de nituit / Nýtovačka / Nitovacie kliešte / Kovičar / Kniediklis / Kniežu stangas / Needitangid / Нутачна / Klijesta za zakovice / Pistolj za pop nitne / Пританаборос / Remachadora para remaches de acero y aluminio / Chiodatrice / Rebitadora / Riveuse / Klinknagelmachine

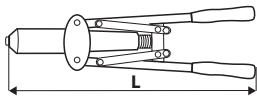

Ref.	L [mm]	☒ [kg]	☒	EAN
43E780	535	1,3	0/10	5902062020130

NITOWNICA

Riveter / Nietmaschine / Заклепочник / Клепальный инструмент / Popszegecszűzó / Mašinã de nituit / Nýtovačka / Nitovacie kliešte / Kovičar / Kniediklis / Kniežu stangas / Needitangid / Нутачна / Klijesta za zakovice / Pistolj za pop nitne / Пританаборос / Remachadora para remaches de acero y aluminio / Chiodatrice / Rebitadora / Riveuse / Klinknagelmachine

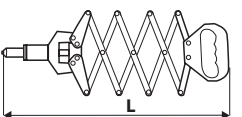

Ref.	L [mm]	☒ [kg]	☒	EAN
43E785	300 - 830	1,9	0/8	5902062020147

NITY

Rivets / Nieten / Закленки / Кленки / Popszegecs / Şuruburi / Nýty / Nit hliníkový trhací / Kovice / Kniedès / Kniedes / Needid / Нутовое / Zakovice / Pop nitne / ΗΛοι / Remaches / Chiodi per metalli / Rebites / Rivets / Klinknagel

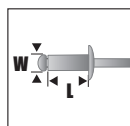

AL



Ref.	WxL [mm]	N	☒	☒	☒	EAN
43E301	3,2 x 8	x50	x		0/400	5902062020154
43E302	3,2 x 10	x50	x		0/400	5902062020192
43E401	4,0 x 8	x50	x		0/200	5902062020161
43E402	4,0 x 10	x50	x		0/200	5902062020949
43E421	4,0 x 10	x800		x	0/20	5902062020987
43E403	4,0 x 12,5	x50	x		0/150	5902062020208
43E404	4,0 x 16	x50	x		0/150	5902062020284
43E405	4,0 x 18	x50	x		0/150	5902062020291
43E501	4,8 x 8	x50	x		0/150	5902062020178
43E502	4,8 x 10	x50	x		0/120	5902062020215
43E521	4,8 x 10	x500		x	0/20	5902062020994
43E503	4,8 x 12,5	x50	x		0/120	5902062020956
43E504	4,8 x 14,5	x50	x		0/120	5902062020222
43E505	4,8 x 18	x50	x		0/100	5902062020307
43E507	4,8 x 23	x50	x		0/100	5902062020314
43E509	4,8 x 28	x50	x		0/90	5902062020321

NITONAKRĘTKI

Nut rivets / Nietmutter / Гайки заклепочные / Кленки мутрови / Popszegecszűzó / Mašinã de nituit piulitã / Nýtové šrouby / Nitové matice / Kovice / Kniedès verzès / Kniežu stangas / Needitangid / Нутачна / Humzãiku / Nitne zakovice / Pistolj za pop nitne / Притана / Remache de rosca / Chiodi autofilettanti / Rebites e porcas / Rivets à jaquette / Moer klinknagel

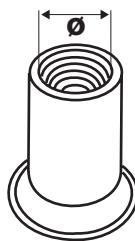

x20

AL



Ref.	Typ	Ø [mm]	☒	EAN
43E123	M3	3,1	0/200	5902062430236
43E124	M4	4,1	0/200	5902062430243
43E125	M5	5,1	0/200	5902062430250
43E126	M6	6,1	0/200	5902062430267

NITOWNICA NA NITONAKRĘTKI

Nut riveter / Nietmaschine für Nietmüttern / Заклепочник для заклепочных гаек / Клепальный инструмент для мутр / Popszegecszűző / Mašina de nituit piuliță / Nýtovačka nýtových šroubů / Kliešte nitovacie / Pištola za kovičenje / Knieđiklis besisukantis / Kniežu stangas / Neetmutritangid / Ημταίχι / Nitne zakovice / Pistolj za pop nitne / Πριταναδόρος για πριταίνια / Remachadora para remaches de rosca / Chiodatrice per chiodo autoflettante / Rebitadora p. Rebites e porcas / Riveuse à rivets à jaquette / Klinknagelmachine voor moer klinknagels

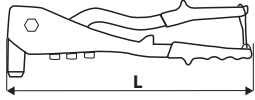

Ref.	L [mm]	[kg]	⊠	EAN
43E110	270	1,1	0/16	5902062430021

SZCZYPCY DO ŁĄCZENIA PROFILI

Metal stud crimping tool / Profilverbindungszange / Заклепочник прошивной для профилей / Клепальный инструмент / Peremezőfogó / Dešte p/u profiluri cu pereți subțiri / Kleště na spojování profilů / Kliešte nitovacie pre sadrokartónové profily / Klešče za spajanje profilov / Replės profiliams jungti / Stangas metalo profiliem / Painūtusnāpitsad poltīdele / Ημταчка / Klijesta za zakovice / Klesta za zakivanje / Πένσα για συνένωση προφίλ / Tenazas para juntas perfiles / Pinza per assemblaggio dei profili / Pinças p. Juntas perfis / Pince à connecter des profils / Tang voor profielen

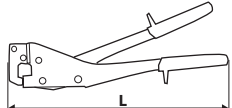

Ref.	L [mm]	⊠	EAN
43E100	350	6/24	5902062430007

SZCZYPCY DO ŁĄCZENIA PROFILI

Metal stud crimping tool / Profilverbindungszange / Заклепочник прошивной для профилей / Клепальный инструмент / Peremezőfogó / Dešte p/u profiluri cu pereți subțiri / Kleště na spojování profilů / Kliešte nitovacie pre sadrokartónové profily / Klešče za spajanje profilov / Replės profiliams jungti / Stangas metalo profiliem / Painūtusnāpitsad poltīdele / Ημταчка / Klijesta za zakovice / Klesta za zakivanje / Πένσα για συνένωση προφίλ / Tenazas para juntas perfiles / Pinza per assemblaggio dei profili / Pinças p. Juntas perfis / Pince à connecter des profils / Tang voor profielen

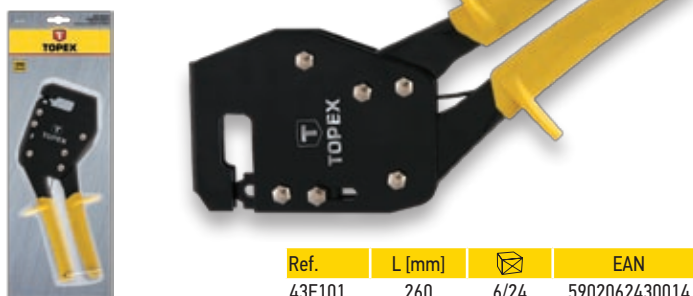
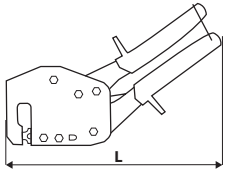

Ref.	L [mm]	⊠	EAN
43E101	260	6/24	5902062430014

NITOWNICA DO KOŁKÓW ROZPOROWYCH

Riveter for expansion pins / Nietpresse für Spreizdübel / Заклепочник для распорных дюбелей / Заклепочник / Tipliző fogó / Presă de nituit / Nýtovačka pro rozpínací kolíky / Nitovačka na rozperné nity / Kovičnik za zakivanje klinov / Profilių kniediklis / Pretbīdņa kniedētājs / Lõõtsaga needitangid / Ημτωαчка за распорни болтове / Alat za zakivanje tipli / Mašina za zakivanje klinova / Πριταναδόρος για κωνικές σφίγγες / Remachadora para pasadores de espiga / Chiodatrice / Rebitadora para pinos / Riveuse pour chevilles expansibles / Klinknagelmachine voor uitzetpennen

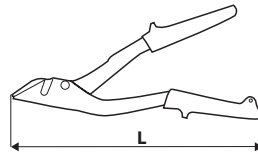

4,0 Ø (mm)
5,0 Ø (mm)
6,0 Ø (mm)

Ref.	L [mm]	⊠	EAN
43E790	255	12/36	5902062427908

NITOWNICA DO KOŁKÓW ROZPOROWYCH

Riveter for expansion pins / Nietpresse für Spreizdübel / Заклепочник для распорных дюбелей / Заклепочник / Tipliző fogó / Presă de nituit / Nýtovačka pro rozpínací kolíky / Nitovačka na rozperné nity / Kovičnik za zakivanje klinov / Profilių kniediklis / Pretbīdņa kniedētājs / Lõõtsaga needitangid / Ημτωαчка за распорни болтове / Alat za zakivanje tipli / Mašina za zakivanje klinova / Πριταναδόρος για κωνικές σφίγγες / Remachadora para pasadores de espiga / Chiodatrice / Rebitadora para pinos / Riveuse pour chevilles expansibles / Klinknagelmachine voor uitzetpennen



3,0 Ø (mm)
4,0 Ø (mm)
5,0 Ø (mm)
6,0 Ø (mm)

Ref.	L [mm]	⊠	EAN
43E791	170	12/24	5902062427915

ZGRZEWARKA

Welder / Schweißmaschine / Сварочный аппарат / Пристрій до зварювання / Hegesztő / Mašina de sudat / Svářečka / Zváraczka / Varilnik / Suvirino aparatas / Metināšanas aparāts / Keevitusaparaat / Zavarčna машина / Aparat za varjenje / Ζαυριναίς / Μηχάνημα συγκόλλησης / Soldadora / Polifusore / Máquina de solda / Soudeuse / Lasarparaat

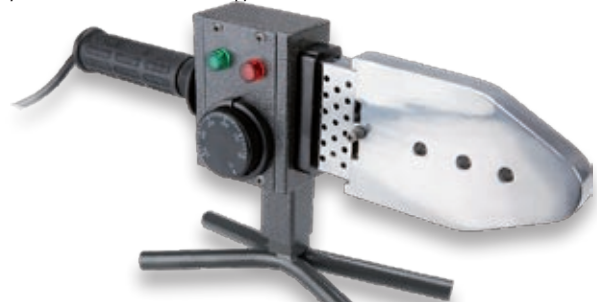

Ref.	P [W]	T [°C]	Ø [mm]	[kg]	⊠	EAN
44E160	800	0 - 300	20, 25, 32, 40	2,9	1/6	5902062441607

LUTOWNICA OPOROWA

Soldering iron / Widerstands-lötKolben / Паяльник контактный / Паяльник / Forrasztópáka / Ciocan de lipit / Odporová páječka / Pájkováčka hrotová odporová / Spajkalnik / Lituoklis / Lodāmurs / Jootekolb / Поаялик / Električna lemilica / Pistolj lemilica / Εμβολο συγκολλησεων / Soldador / Soldatoio da resistencia / Soldador por resistència / Fer à souder à résistance / Weerstand soldeerbout

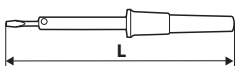

Ref.	P [W]	L [mm]	☒	EAN
44E024	40	217	0/50	5902062172327
44E026	60	237	0/50	5902062172334
44E029	100	273	25/50	5902062020574

LUTOWNICA OPOROWA

Soldering iron / Widerstands-lötKolben / Паяльник контактный / Паяльник / Forrasztópáka / Ciocan de lipit / Odporová páječka / Pájkováčka hrotová odporová / Spajkalnik / Lituoklis / Lodāmurs / Jootekolb / Поаялик / Električna lemilica / Pistolj lemilica / Εμβολο συγκολλησεων / Soldador / Soldatoio da resistencia / Soldador por resistència / Fer à souder à résistance / Weerstand soldeerbout

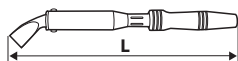

Ref.	P [W]	L [mm]	☒	EAN
44E030	150	350	10/20	5902062440303
44E031	200	355	10/20	5902062440310
44E032	300	363	10/20	5902062440327

LUTOWNICA TRANSFORMATOROWA

Soldering gun / Trafo-LötKolben / Паяльник трансформаторный / Паяльный пистолет / Forrasztópisztoly / Ciocan de lipit / Pájeci stanice s transformátorem / Pájkováčka elektronická / Spajkalnik / Transformatorinis lituoklis / Lodāmurs ar transformātoru / Jootepüstol / Поаялик / Pištolj lemilica / Pistolj lemilica / Ηλεκτρικό κολλητήρι με μετασχηματιστή / Pistola para soldar / Soldatoio da trasformatore / Soldador por transformador / Fer à souder redresseur / Transformator soldeerbout



Ref.	P [W]	☒	EAN
44E002	100	10/20	5902062021045

LUTOWNICA TRANSFORMATOROWA

Soldering gun / Trafo-LötKolben / Паяльник трансформаторный / Паяльный пистолет / Forrasztópisztoly / Ciocan de lipit / Pájeci stanice s transformátorem / Pájkováčka elektronická / Spajkalnik / Transformatorinis lituoklis / Lodāmurs ar transformātoru / Jootepüstol / Поаялик / Pištolj lemilica / Pistolj lemilica / Ηλεκτρικό κολλητήρι με μετασχηματιστή / Pistola para soldar / Soldatoio da trasformatore / Soldador por transformador / Fer à souder redresseur / Transformator soldeerbout



Ref.	P [W]	☒ [kg]	☒	EAN
44E005	150	1,5	0/10	5902062671509

KOŃCÓWKI DO LUTOWNICY TRANSFORMATOROWEJ

Tips for soldering gun / Trafo-LötKolbenendstücke / Наконечники на паяльник трансформаторный / Наконечники для паяльного пистолета / Pákcacsúcs / Canule ciocan de lipit / Концовки до páječky s transf. / Hroty náhradné / Nastavki za spajkalnik / Transformatorinio lituoklio antgaliai / Uzgalj lodāmuram ar transformātoru / Jootepüstoli otsikud / Накраўнік за поаялик / Nastavci za pištolj lemilicu / Nastavci za pistolj lemilicu / Μύτες ηλεκτρικού κολλητηρίου με μετασχηματιστή / Puntas para pistola de soldar / Punte per soldatoio da trasformatore / Ponteiros p. soldador / Embouts de fer à souder redresseur / Eindstuk voor transformator solderen



Ref.	do lutownicy	N	☒	EAN
44E007	44E002, 44E005	2	25/100	5902062440075

ODSYSACZ CYNW

Desoldering pump / Zinn-Absauger / Пистолет для снятия припоя / Циновідсмоктувач / Ónszippantó / Dispozitiv de aspirarea cositorului / Odsavač cinu / Odsávač cinu / Odstranjevalec cina / Alavo siurblys / Lodālvas atsūkņētājs / Tinaimur / Καπνοαπομπα / Sisaljka za kositar / Usisivač za kalaj / Αντλία αφαίρεσης κόλλησης / Dispositivo de aspiración de estaño / Aspirastagno / Máquina de remover estanho / Pompe à braser à l'étain / Tinafzuiger

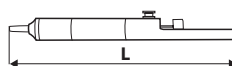

Ref.	L [mm]	☒	EAN
44E006	190	100/200	5902062440068

SPOIWO LUTOWNICZE

Solder wire / Lötlegierung / Присадочный паяльный материал / Люта / Forrasz / Liant / Pojivo pro pájeni / Spájka / Spajkalna žica / Litavimo medžiaga / Lodešanas saistviela / Jootetäide / Πρνοή / Spojnica za lemjenje / Vezivo za lemjenje / Καλί / Metal de aportación para soldadura / Stagno per soldatura / Solda / Liant de brasure / Soldeermaald



Ref.	Sn %	Ø [mm]	m [g]	topnik	☒	EAN
44E512	60	0,7	100	SW 26	0/190	5902062020680
44E514	60	1,0	100	SW 26	0/190	5902062020703
44E522	60	1,0	100	SW 26B	0/190	5902062020741
44E524	60	1,5	100	SW 26B	0/190	5902062020765
44E532	60	1,5	100	SW 21	0/190	5902062020789

LUT CYNOWY

Tin solder / Lötzinn / Припой оловянный / Люта цинова / Forrasztóó gyantás / Alija de lipit din cositor / Cinová pájka / Cin pajkovaci / Tinol žica / Alluminio lydmetalis / Lodalva / Tinajoodis / Тунол / Tinol žica / Tinol zica / Καλί / Soldadura de estaño / Lega per saldatura di stagno / Solda / Soudure d'étain / Zink soldeemaald



Ref.	Sn %	Cu %	Ø [mm]	m [g]	☒	EAN
44E742	97	3	2,5	100	0/180	5902062020802

LUT CYNOWY

Tin solder / Lötzinn / Припой оловянный / Люта цинова / Forrasztóó gyantás / Alija de lipit din cositor / Cinová pájka / Cin pajkovaci / Tinol žica / Alluminio lydmetalis / Lodalva / Tinajoodis / Тунол / Tinol žica / Tinol zica / Καλί / Soldadura de estaño / Lega per saldatura di stagno / Solda / Soudure d'étain / Zink soldeemaald

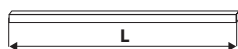

Ref.	Sn %	Ø [mm]	L [mm]	☒	EAN
44E519	60	7 x 7	250	0/70	5902062020727

KALAFONIA

Calophony / Kolophonium / Канифоль / Канифоль / Forrasztó gyantra / Colofoni (sacâz) / Kalafuna / Kolofónia / Kalafonija / Kanifolija / Kolofonijis / Vaik / Колофон / Kalafonija / Kolofonijum / Καλοφωνια πίσσα / Colofonia / Colofonia / Colofónia / Colophane / Colofonium



Ref.	m [ml/g]	☒	EAN
44E812	35	0/180	5902062020826

ТОПНИК

Paste flux / Flussmittel / Флюс / Паста-флюс / Forrasztókrém / Flux pastă / Tavicí přísady / Pasta na pájkovanie / Tinol žica / Litavimo pasta flusos / Lodpasta / Jootepasta / Паста за запояване / Tinol pasta / Tinol zica / Πάστα συγκόλλησης / Fundente: pasta / Fondente / Fundente / Décapant / Flux



Ref.	m [ml/g]	☒	EAN
44E816	35	0/180	5902062020840

ZESTAW DO LUTOWANIA

Soldering kit / LötKolben-Set / Набор для пайки / Набор до лютування / Forrasztókészlet / Gamitură de lipit cu aliaje / Sada pro pájení / Spájkovacia súprava / Komplet za sprajkanje / Kompletas litavimui / Lodšanas komplekts / Jootmiskomplekt / Комплект за запояване / Set za lemjenje / Pribor za lemjenje / Σετ συγκόλλησης / Equipo para solda / Completo per saldatura / Kit p. Soldagem / Jeu de brasage / Soldeerset



Ref.	☒	EAN
44E731	lut cynowy 60% Sn, Ø 1,5mm, SW21, 100g + kalafonia 35ml	0/120 5902062209412

ZESTAW DO LUTOWANIA

Soldering kit / LötKolben-Set / Набор для пайки / Набор до лютування / Forrasztókészlet / Gamitură de lipit cu aliaje / Sada pro pájení / Spájkovacia súprava / Komplet za sprajkanje / Kompletas litavimui / Lodšanas komplekts / Jootmiskomplekt / Комплект за запояване / Set za lemjenje / Pribor za lemjenje / Σετ συγκόλλησης / Equipo para solda / Completo per saldatura / Kit p. Soldagem / Jeu de brasage / Soldeerset



Ref.	☒	EAN
44E732	lut cynowy 60% Sn, Ø 1,5mm, SW21, 100g + pasta 35ml	0/120 5902062209429

ZESTAW DO LUTOWANIA

Soldering kit / LötKolben-Set / Набор для пайки / Набор до лютування / Forrasztókészlet / Gamitură de lipit cu aliaje / Sada pro pájení / Spájkovacia súprava / Komplet za sprajkanje / Kompletas litavimui / Lodšanas komplekts / Jootmiskomplekt / Комплект за запояване / Set za lemjenje / Pribor za lemjenje / Σετ συγκόλλησης / Equipo para solda / Completo per saldatura / Kit p. Soldagem / Jeu de brasage / Soldeerset



Ref.	☒	EAN
44E745	lut cynowy 97% Sn, 3% Cu, Ø 2,5mm, 100g + topnik 100g	0/120 5902062209436

ZESTAW DO LUTOWANIA

Soldering kit / LötKolben-Set / Набор для пайки / Набор до лютування / Forrasztókészlet / Garnitură de lipit cu aliaje / Sada pro pájení / Sprájkovacia súprava / Komplet za sprajkanje / Komplektas litavimui / Lodēšanas komplekts / Jootmiskomplekt / Комплект за запояване / Set za lemljenje / Pribor za lemjenje / Σετ συγκόλλησης / Equipo para solda / Completo per saldatura / Kit p. Soldagem / Jeu de brasage / Soldeerset



Ref.	T [°C]	q [g/h]	P [kW]	⊠	EAN
44E110	1850	140	2	0/10	5902062441102

ZESTAW DO LUTOWANIA

Soldering kit / LötKolben-Set / Набор для пайки / Набор до лютування / Forrasztókészlet / Garnitură de lipit cu aliaje / Sada pro pájení / Sprájkovacia súprava / Komplet za sprajkanje / Komplektas litavimui / Lodēšanas komplekts / Jootmiskomplekt / Комплект за запояване / Set za lemljenje / Pribor za lemjenje / Σετ συγκόλλησης / Equipo para solda / Completo per saldatura / Kit p. Soldagem / Jeu de brasage / Soldeerset



Ref.	T [°C]	q [g/h]	P [kW]	⊠	EAN
44E111	1850	140	2	0/10	5902062441119

ZESTAW PALNIKÓW

Burners set / Brenner-Set / Набор зажигателей / Набор пальників / Égő készlet / Set de suflaie / Sada hořáků / Súprava horákov / Komplet vžigalnikov / Degiklij komplektas / Degļu komplekts / Põletikomplekt / Комплект от горелки / Set grijača / Komplet gorionika / Σετ αναφλεκτήρων / Juego de sopletes / Set di bruciatori / Kit de Maçaricos / Jeu de chalumeaux / Set van branders



Ref.	T [°C]	q [g/h]	P [kW]	⊠ [kg]	⊠	EAN
44E115	1850	2000	19,5	0,9	0/6	5902062441157

ZESTAW PALNIKÓW

Burners set / Brenner-Set / Набор зажигателей / Набор пальників / Égő készlet / Set de suflaie / Sada hořáků / Súprava horákov / Komplet vžigalnikov / Degiklij komplektas / Degļu komplekts / Põletikomplekt / Комплект от горелки / Set grijača / Komplet gorionika / Σετ αναφλεκτήρων / Juego de sopletes / Set di bruciatori / Kit de Maçaricos / Jeu de chalumeaux / Set van branders



Ref.	T [°C]	q [g/h]	P [kW]	⊠ [kg]	⊠	EAN
44E120	1400	2000	28	1,1	0/10	5902062441201

ZESTAW PALNIKÓW

Burners set / Brenner-Set / Набор зажигателей / Набор пальників / Égő készlet / Set de suflaie / Sada hořáků / Súprava horákov / Komplet vžigalnikov / Degiklij komplektas / Degļu komplekts / Põletikomplekt / Комплект от горелки / Set grijača / Komplet gorionika / Σετ αναφλεκτήρων / Juego de sopletes / Set di bruciatori / Kit de Maçaricos / Jeu de chalumeaux / Set van branders



Ref.	T [°C]	q [g/h]	P [kW]	⊠ [kg]	⊠	EAN
44E116	1850	max 265	3,8	3,9	0/6	5902062441164

ZESTAW PALNIKÓW

Burners set / Brenner-Set / Набор зажигателей / Набор пальників / Égő készlet / Set de suflaie / Sada hořáků / Súprava horákov / Komplet vžigalnikov / Degiklij komplektas / Degļu komplekts / Põletikomplekt / Комплект от горелки / Set grijača / Komplet gorionika / Σετ αναφλεκτήρων / Juego de sopletes / Set di bruciatori / Kit de Maçaricos / Jeu de chalumeaux / Set van branders



Ref.	T [°C]	q [g/h]	P [kW]	⊠ [kg]	⊠	EAN
44E117	1850	max 2000	28	5,6	0/6	5902062441171

PALNIK GAZOWY

Gas burner / Gasbrenner / Горелка газовая / Пальник газовий / Forrasztófej / Arzător de gaz / Plynový hořák / Horák / Plinski gorilnik / Dujinis degiklis / Gāzes deglis / Gaasiipoleti / На крайник за горелка / Nastavak za plamenik / Gasna lemilica / Καυστήρας υπραερίου / Soplete / Bruciatore a gas / Maçarico de gás / Chalumeau à gaz / Gasbrander



Ref.	W [mm]	Ø [mm]	q [g/h]	P [kW]	⊠	EAN
44E131	22 mm	-	150	2,1	0/80	5902062441317
44E132	40 mm	-	265	3,7	0/40	5902062441324
44E133	40 mm	-	265	3,7	0/40	5902062441331
44E134	-	10 mm	100	1,4	0/60	5902062441348
44E135	-	25 mm	265	3,7	0/60	5902062441355
44E136	-	35 mm	450	6,3	0/60	5902062441362

LUTOWNICA GAZOWA

Soldering torch / Gaslötkolben / Газовый паяльник / Лютувальник газовий / Gáz forrasztópápa / Ciocan de lipit,cu gaz / Plynová páječka / Plynová spájkováčka / Plinski spajkalnik / Dujinis lituoklis / Gāzes lodāturs / Gaasiioetekolb / Газов паяльник / Plinska lemilica / Gasna lemilica / Καυτήρο / Soldadura a gas / Soldatoio / Soldador de gás / Fer à souder à gaz / Gassoldeerboot



Ref.	T [°C]	q [g/h]	P [kW]	⊠ [kg]	⊠	EAN
44E118	1850	140	2	1,1	0/6	5902062441188

GROT DO LUTOWNICY GAZOWEJ

Copper mallet / Lötlspitze für Gaslötkolben / Насадка паяльная / Наконечник до газового паяльника / Forrasztóhegy gázforrasztóhoz / Ciocan Cu, pentru lipire cu gaz / Hrot k plynové páječce / Hrot do plynovej spájkováčky / Konica za plinski spajkalnik / Dujinio lituoklio antgalis / Lodātura uzgalis / Gaasiioetekolbi otsak / Човка за газоз паяльник / Mlat za plinsku lemilicu / Vrh za plinsku lemilicu / Ακροφύσιο για φλόγιτρο / Soldador para equipo de soldadura a gas Mazzetta per soldatore a gas / Ponteiro p. Soldador de gás / Panne de fer à souder à gaz / Gassoldeerpunt



Ref.	T [°C]	m [g]	⊠	EAN
44E118-1	1850	200	0/24	5902062441195

ZESTAW DEKARSKI

Roofwork kit / Dachdecker-Set / Набор кровельщина / Набор дахарський / Bádagos készlet / Set de țiglărie / Pokrývačská sada / Pokrývačská súprava / Komplet za krovce / Komplektas stogdengijui / Jumiķa komplekts / Katusepanijakomplekt / Покривачески комплект / Кроворокриваї set / Krovni komplet / Σετ στεγαστή / Juego de herramientas de techador / Kit cannello bruciatore / Kit especial / Jeu d'outils de couvreur / Dakwerkset



Ref.	T [°C]	q [g/h]	P [kW]	⊠ [kg]	⊠	EAN
44E122	1850	4000	58	1,5	0/6	5902062441225

ZESTAW DEKARSKI

Roofwork kit / Dachdecker-Set / Набор кровельщина / Набор дахарський / Bádagos készlet / Set de țiglărie / Pokrývačská sada / Pokrývačská súprava / Komplet za krovce / Komplektas stogdengijui / Jumiķa komplekts / Katusepanijakomplekt / Покривачески комплект / Кроворокриваї set / Krovni komplet / Σετ στεγαστή / Juego de herramientas de techador / Kit cannello bruciatore / Kit especial / Jeu d'outils de couvreur / Dakwerkset



Ref.	T [°C]	q [g/h]	P [kW]	⊠ [kg]	⊠	EAN
44E121	1850	7800	110	1,5	0/6	5902062441218

ZESTAW DEKARSKI

Roofwork kit / Dachdecker-Set / Набор кровельщина / Набор дахарський / Bádagos készlet / Set de țiglărie / Pokrývačská sada / Pokrývačská súprava / Komplet za krovce / Komplektas stogdengijui / Jumiķa komplekts / Katusepanijakomplekt / Покривачески комплект / Кроворокриваї set / Krovni komplet / Σετ στεγαστή / Juego de herramientas de techador / Kit cannello bruciatore / Kit especial / Jeu d'outils de couvreur / Dakwerkset



Ref.	T [°C]	q [g/h]	P [kW]	⊠ [kg]	⊠	EAN
44E123	1850	6900	99	1,8	0/6	5902062441232

WAŻ PRZYŁĄCZENIOWY DO GAZU

Gas connecting hose / Gasumschalt Schlauch / Шланг газоподводящий / Шланг газовий / Gázbekötő tömlő / Furtun de racord, pentru alimentare gaz / Přípojná hadice na plyn / Přípojná hadica na plyn / Priključna cev za plin / Prijungimo vamzdis, dujoms / Gāzes pievadšūtene / Gaasiühendusvoolik / Газопроводен маркуч / Priključno crijevo za plin / Priključno crevo za gas / Εύκαμπτος σωλήνας παροχής αερίου / Manguera de conexión para gas / Tubo di collegamento del gas / Mangueira de ligação p. Gás / Tuyau flexible de raccordement à gaz / Verbindings slang voor gas

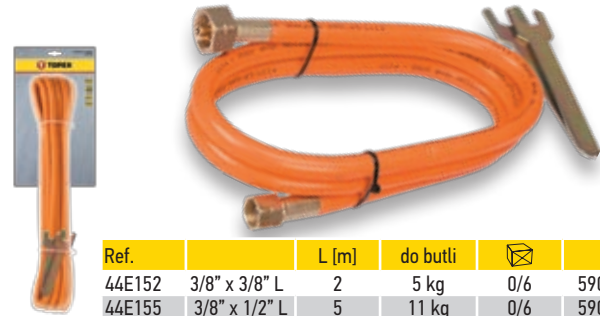

Ref.	L [m]	do butli	⊠	EAN	
44E152	3/8" x 3/8" L	2	5 kg	0/6	5902062441232
44E155	3/8" x 1/2" L	5	11 kg	0/6	5902062441553

REDUKCJA DO BUTLI

Reduction for cylinder / Reduzierstück für Flasche / Редуктор для бутлы / Редуктор на балон / Gázpalack szűkítőcsavar / Reducție la butelie / Reducție la lăhve / Adapter na kartuše / Ventil za jeklenko / Dujų baliono reduktorius / Reduktors / Balloonreduktor / Редукция за бутылката / Redukcija za bocu / Smanjenje za cilindar / Μειωτήρας για δοχείο / Adaptador para botella / Riduzione / Redução p. Garraões / Réduction pour bouteille / Reductiestuk voor flessen



Ref.	⊠	EAN
44E139	0/50	5902062441393

LAMPA LUTOWNICZA

Liquid gas blow-lamp / Löttlampe / Лампа паяльная / Газ рідкий для лампи паяльної / Forrasztókészülék / Lampă sudat cu gaz lichid / Pájecí lampa / Pájkováčka plynová / Plinski gorilnik / Litavimo lempa / Lodlampa / Jootelamp (vedelgaas) / Лампа газова / Plinska lemilica / Gasna lemilica / Καμινέτο υγραερίου / Lámpara de soldar a gas / Lampada per saldare / Lâmpada p. Soldar / Lampe à braser / Soldeerlamp



Ref.	T [°C]	q [g/h]	P [kW]	☒	EAN
44E141	1350	180	1,9	0/14	5902062441430

LAMPA LUTOWNICZA

Liquid gas blow-lamp / Löttlampe / Лампа паяльная / Газ рідкий для лампи паяльної / Forrasztókészülék / Lampă sudat cu gaz lichid / Pájecí lampa / Pájkováčka plynová / Plinski gorilnik / Litavimo lempa / Lodlampa / Jootelamp (vedelgaas) / Лампа газова / Plinska lemilica / Gasna lemilica / Καμινέτο υγραερίου / Lámpara de soldar a gas / Lampada per saldare / Lâmpada p. Soldar / Lampe à braser / Soldeerlamp



Ref.	T [°C]	q [g/h]	P [kW]	☒	EAN
44E144	1350	180	1,9	0/14	5902062441447

LAMPA LUTOWNICZA

Liquid gas blow-lamp / Löttlampe / Лампа паяльная / Газ рідкий для лампи паяльної / Forrasztókészülék / Lampă sudat cu gaz lichid / Pájecí lampa / Pájkováčka plynová / Plinski gorilnik / Litavimo lempa / Lodlampa / Jootelamp (vedelgaas) / Лампа газова / Plinska lemilica / Gasna lemilica / Καμινέτο υγραερίου / Lámpara de soldar a gas / Lampada per saldare / Lâmpada p. Soldar / Lampe à braser / Soldeerlamp



Ref.	T [°C]	q [g/h]	P [kW]	☒	EAN
44E142	1350	180	1,9	0/14	5902062441416

LAMPA LUTOWNICZA

Liquid gas blow-lamp / Löttlampe / Лампа паяльная / Газ рідкий для лампи паяльної / Forrasztókészülék / Lampă sudat cu gaz lichid / Pájecí lampa / Pájkováčka plynová / Plinski gorilnik / Litavimo lempa / Lodlampa / Jootelamp (vedelgaas) / Лампа газова / Plinska lemilica / Gasna lemilica / Καμινέτο υγραερίου / Lámpara de soldar a gas / Lampada per saldare / Lâmpada p. Soldar / Lampe à braser / Soldeerlamp



Ref.	T [°C]	q [g/h]	P [kW]	☒	EAN
44E143	1350	180	1,9	0/14	5902062021021

NABÓJ Z GAZEM BUTAN

Butane gas cartridge / Butan-Gas-Patrone / Баллон с газом бутан / Балончики (картридж) з газом бутан / Bután gázpatron / Cartuş cu gaz butan / Kartuşe s plynem butan / Butánová kartuša / Jeklenka s plinom butan / Butano dujų balionas / Balons ar butāna gāzi / Butaan-gaaspadrun / Бутылка с газ бутан / Patrona sa butan plinom / Patrona sa butan gasom / Δοχείο με μείγμα προπανίου / Cartucho de gas butano / Cartuccia di gas butano / Cartouxo com gás / Cartouche avec gaz butane / Butaan vervangcartridge



190
M (g)

EN417

Ref.	☒	EAN
44E151	0/48	5902062441515

MIKROPALNIK

Microtorch / Mikrobrenner / Микрогорелка / Мініпаяльник / Gázforrasztó mini / Microinjector / Mikrohořák / Mikro pájkováčka / Gorilnik / Mikro degiklis / Lodlampa mini / Mikroleeklamp / Топелка микро / Mikro Plinska lemilica / Mikro gasna lemilica / Φλόγιστρο / Microsoplete / Microbruciatore / Mikromaçanico / Micro-brûleur / Microbrander



Ref.	T [°C]	V [ml]	☒	EAN
44E106	1300	28	10/20	5902062441065

MIKROPALNIK

Microtorch / Mikrobrenner / Микрогорелна / Мініпаяльник / Gázforrasztó mini / Microinjector / Mikrohořák / Mikro rajkovačka / Gorilnik / Mikro degiklis / Lodlampa mini / Mikroleeklamp / Горелка микро / Mikro Plinska lemilica / Mikro gasna lemilica / Φλόγιστρο / Microsoplete / Microbruciatore / Mikromaçarico / Micro-brûleur / Microbrander



Ref.	T [°C]	V [ml]	☒	EAN
44E108	200-400	12	0/20	5902062441089

MIKROPALNIK

Microtorch / Mikrobrenner / Микрогорелна / Мініпаяльник / Gázforrasztó mini / Microinjector / Mikrohořák / Mikro rajkovačka / Gorilnik / Mikro degiklis / Lodlampa mini / Mikroleeklamp / Горелка микро / Mikro Plinska lemilica / Mikro gasna lemilica / Φλόγιστρο / Microsoplete / Microbruciatore / Mikromaçarico / Micro-brûleur / Microbrander



Ref.	T [°C]	V [ml]	☒	EAN
44E102	1300	12	12/96	5902062441027



Budowlane
Building
Строительные



TOPEX

MŁOTEK ŚLUSARSKI

Machinist hammer / Schlosserhammer / Молоток столярный / Молоток слюсарный / Kalapács / Zámečnické kladívko / Kladivo zámočnické / Ključavničarsko kladivo / Plaktukas šaltkalviui / Āmurs atslēdznieka / Lukksepahaamer / Чук / Bravarski čekić / Cekic / Σφυρί μεταλλοτεχνίτη / Martillo de cerrajero / Martello di fabbro / Martelo p. Fechos / Martelet de serrurier / Slijphamer

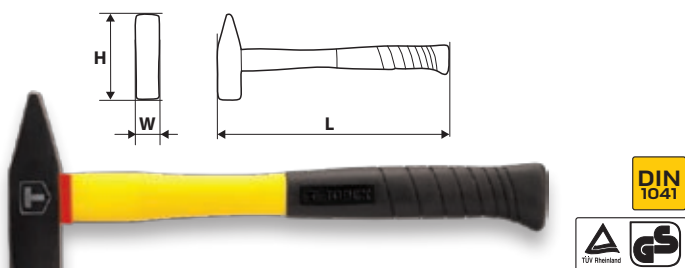

Ref.	L [mm]	H [mm]	W [mm]	m [g]	☒	EAN
02A803	295	105	22	300	6/48	5902062031105
02A805	313	117	28	500	6/36	5902062031112
02A808	350	130	33	800	6/24	5902062031167
02A810	350	135	37	1000	6/24	5902062031174

MŁOTEK STOLARSKI

Claw hammer / Tischlerhammer / Молоток плотничий / Молоток столярський / Szeghúzókalapács / Ciocan tâmplar / Truhlářské kladívko / Kladivo stolárske / Tesarsko kladivo / Plaktukas staliui / Āmurs galdnieka / Sörghaamer / Чук кози крак / Stolarski čekić / Cekic / Σφυρί ξυλουργού / Martillo de carpintero / Martello di falegname / Martelo p. madeira / Martelet de menuisier / Tanghamer

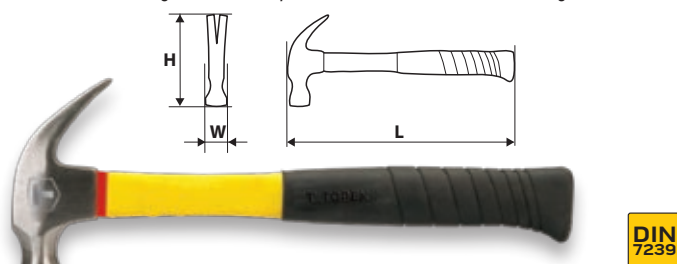

Ref.	L [mm]	H [mm]	W [mm]	m [g]	☒	EAN
02A704	395	154	46	450	6/36	5902062031099

MŁOTEK CIESIELSKI

Carpenter's hammer / Zimmererhammer / Молоток шиферный / Молоток теслярський / Kalapács / Młotek ślusarski / Zámečnické kladívko / Kladivo zámočnické / Ključavničarsko kladivo / Plaktukas dailidei / Namdara āmurs / Tislerihaamer / Дереводельски чук / Tesarski čekić / Stolarski čekić / Σφυρί πέτρας / Martillo de carpintero / Martello da carpentiere / Martelo de marcenaria / Martelet de charpentier / Timmermanshamer

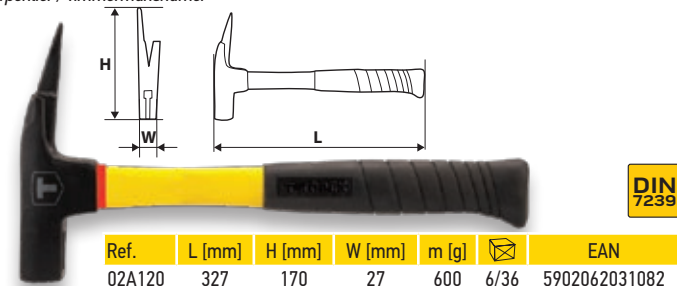

Ref.	L [mm]	H [mm]	W [mm]	m [g]	☒	EAN
02A120	327	170	27	600	6/36	5902062031082

MŁOTEK ŚLUSARSKI

Machinist hammer / Schlosserhammer / Молоток столярный / Молоток слюсарный / Kalapács / Zámečnické kladívko / Kladivo zámočnické / Ključavničarsko kladivo / Plaktukas šaltkalviui / Āmurs atslēdznieka / Lukksepahaamer / Чук / Bravarski čekić / Cekic / Σφυρί μεταλλοτεχνίτη / Martillo de cerrajero / Martello di fabbro / Martelo p. Fechos / Martelet de serrurier / Slijphamer

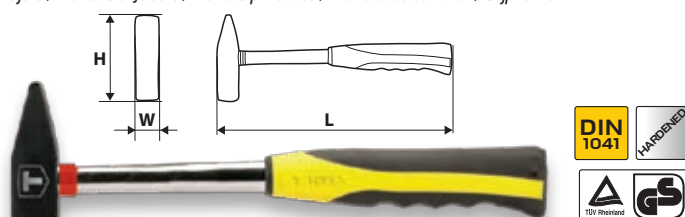

Ref.	L [mm]	H [mm]	W [mm]	m [g]	☒	EAN
02A713	303	103	23	300	6/36	5902062031624
02A715	318	116	29	500	6/36	5902062031631

MŁOTEK CIESIELSKI

Carpenter's hammer / Zimmererhammer / Молоток шиферный / Молоток теслярський / Kalapács / Ācskalapács / Ciocan dulgerie / Tesařské kladívko / Tesárske kladívko / Mizarsko kladivo / Plaktukas dailidei / Namdara āmurs / Tislerihaamer / Дереводельски чук / Tesarski čekić / Stolarski čekić / Σφυρί πέτρας / Martillo de carpintero / Martello da carpentiere / Martelo de marcenaria / Martelet de charpentier / Timmermanshamer

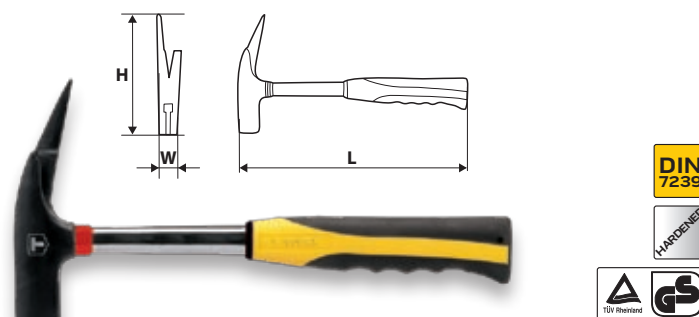

Ref.	L [mm]	H [mm]	W [mm]	m [g]	☒	EAN
02A140	320	175	28	600	6/36	5902062031600

MŁOTEK MURARSKI

Masonry hammer / Maurerhammer / Молоток-кирочка / Молоток мулярський / Kóftíves kalapács / Ciocan zidarie / Zednické kladívko / Kladivo murárske / Zidarsko kladivo / Plaktukas mūríninkui / Āmurs mūrnieka / Müüriwasar / Чук / Zidarski čekić / Cekic / Σφυρί κίση / Piqueta de albañil / Martello di muratore / Martelo p. Alvenaria / Martelet de maçons / Metselaarshamer

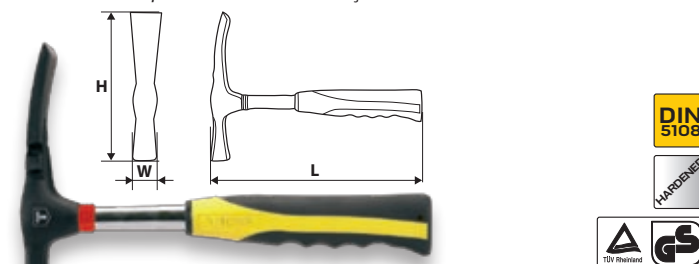

Ref.	L [mm]	H [mm]	W [mm]	m [g]	☒	EAN
02A625	288	200	26	600	6/36	5902062031617

MŁOTEK ŚLUSARSKI

Machinist hammer / Schlosserhammer / Молоток столярный / Молоток слюсарный / Kalapács / Młotek ślusarski / Zámečnické kladívko / Kladivo zámočnické / Ključavničarsko kladivo / Plaktukas šaltkalviui / Āmurs atslēdznieka / Lukksepahaamer / Чук / Bravarski čekić / Cekic / Σφυρί μεταλλοτεχνίτη / Martillo de cerrajero / Martello di fabbro / Martelo p. Fechos / Martelet de serrurier / Slijphamer

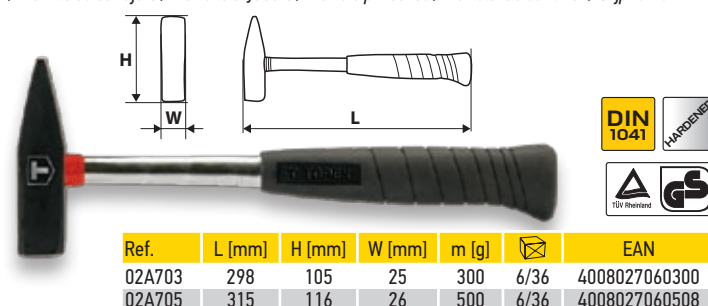

Ref.	L [mm]	H [mm]	W [mm]	m [g]	☒	EAN
02A703	298	105	25	300	6/36	4008027060300
02A705	315	116	26	500	6/36	4008027060508

MŁOTEK STOLARSKI

Claw hammer / Tischlerhammer / Молоток плотничий / Молоток столярський / Szeghúzókalapács / Ciocan tâmplar / Truhlářské kladívko / Kladivo stolárske / Tesarsko kladivo / Plaktukas staliui / Āmurs galdnieka / Sörghaamer / Чук кози крак / Stolarski čekić / Cekic / Σφυρί ξυλουργού / Martillo de carpintero / Martello di falegname / Martelo p. madeira / Martelet de menuisier / Tanghamer

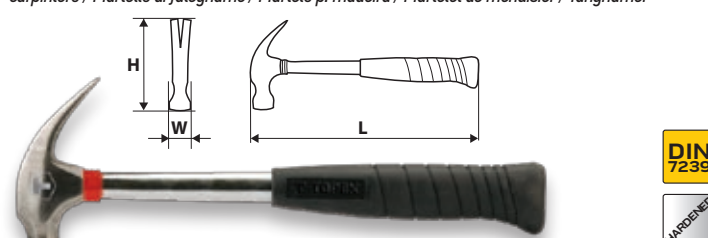

Ref.	L [mm]	H [mm]	W [mm]	m [g]	☒	EAN
02A706	332	127	28	450	6/36	5902062030962

MŁOTEK CIESIELSKI

Carpenter's hammer / Zimmererhammer / Молоток шиферный / Молоток теслярский / Ácskalapács / Ciocan dulgerie / Tesařské kladivo / Tesárske kladivo / Mizarsko kladivo / Plaktukas dailidei / Namdara āmurs / Tislerihammer / Дърводелски чук / Tesarski čekić / Stolarski čekić / Σφυρί πέτρας / Martillo de carpintero / Martello da carpentiere / Martelo de marcenaria / Martelet de charpentier / Timmermanshamer

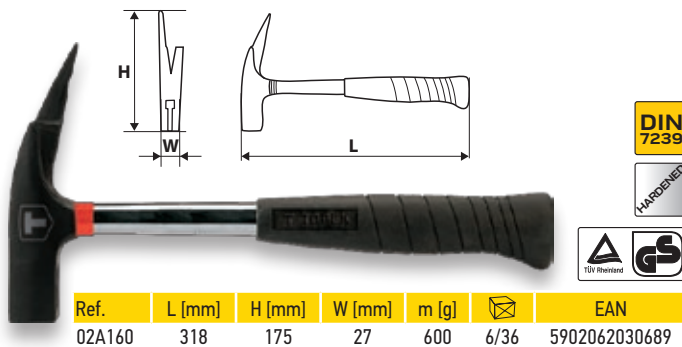

Ref.	L [mm]	H [mm]	W [mm]	m [g]	⊠	EAN
02A160	318	175	27	600	6/36	5902062030689

MŁOTEK MURARSKI

Masonry hammer / Maurerhammer / Молоток-кирочка / Молоток мулярский / Kőműves kalapács / Ciocan zidărie / Zednické kladivo / Kladivo murárske / Zidarsko kladivo / Plaktukas mūrīninkui / Āmurs mūrnieka / Mūiūnivasar / Чук / Zidarski čekić / Cekic / Σφυρί κτίστη / Piqueta de albañil / Martello di muratore / Martelo p. Alvenaria / Martelet de maçons / Metselaarshamer

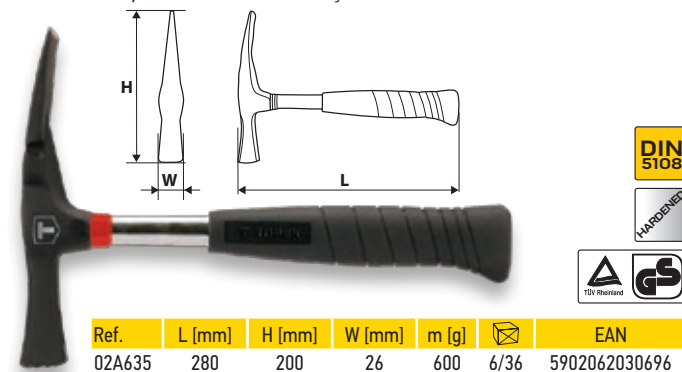

Ref.	L [mm]	H [mm]	W [mm]	m [g]	⊠	EAN
02A635	280	200	26	600	6/36	5902062030696

MŁOTEK MURARSKI

Masonry hammer / Maurerhammer / Молоток-кирочка / Молоток мулярский / Kőműves kalapács / Ciocan zidărie / Zednické kladivo / Kladivo murárske / Zidarsko kladivo / Plaktukas mūrīninkui / Āmurs mūrnieka / Mūiūnivasar / Чук / Zidarski čekić / Cekic / Σφυρί κτίστη / Piqueta de albañil / Martello di muratore / Martelo p. Alvenaria / Martelet de maçons / Metselaarshamer

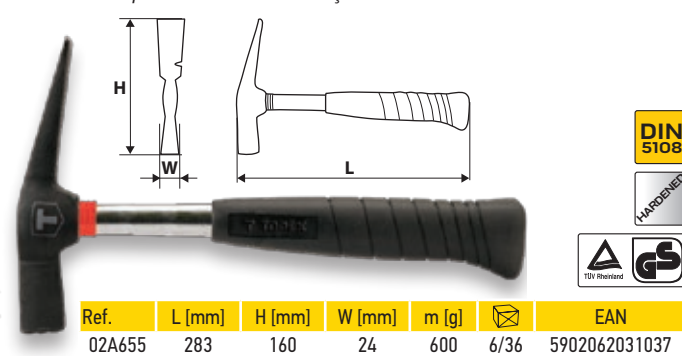

Ref.	L [mm]	H [mm]	W [mm]	m [g]	⊠	EAN
02A655	283	160	24	600	6/36	5902062031037

MŁOTEK MURARSKI

Masonry hammer / Maurerhammer / Молоток-кирочка / Молоток мулярский / Kőműves kalapács / Ciocan zidărie / Zednické kladivo / Kladivo murárske / Zidarsko kladivo / Plaktukas mūrīninkui / Āmurs mūrnieka / Mūiūnivasar / Чук / Zidarski čekić / Cekic / Σφυρί κτίστη / Piqueta de albañil / Martello di muratore / Martelo p. Alvenaria / Martelet de maçons / Metselaarshamer

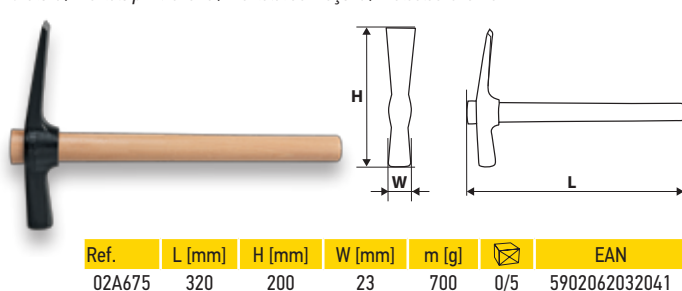

Ref.	L [mm]	H [mm]	W [mm]	m [g]	⊠	EAN
02A675	320	200	23	700	0/5	5902062032041

MŁOTEK CIESIELSKI

Carpenter's hammer / Zimmererhammer / Молоток с остроконечным бойком / Молоток теслярский / Ácskalapács / Ciocan dulgerie / Tesařské kladivo / Tesárske kladivo / Mizarsko kladivo / Plaktukas dailidei / Namdara āmurs / Tislerihammer / Дърводелски чук / Tesarski čekić / Stolarski čekić / Σφυρί πέτρας / Martillo de carpintero / Martello da carpentiere / Martelo de marcenaria / Martelet de charpentier / Timmermanshamer

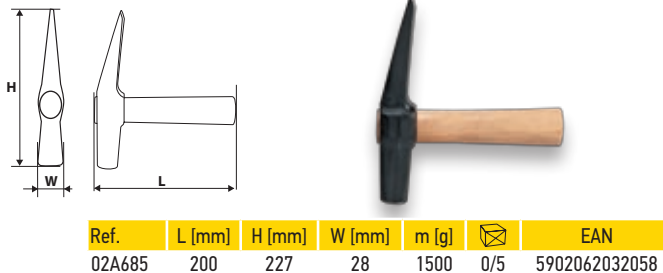

Ref.	L [mm]	H [mm]	W [mm]	m [g]	⊠	EAN
02A685	200	227	28	1500	0/5	5902062032058

ТОПОРЕК УНИВЕРСАЛНУ

Hatchet / Universalbeil / Топорик универсальный / Сокира универсальна / Gipszvágóbalt / Toporás / Sekerka univerzální / Sekerka tesárska / Sekira / Universalus kirvis / Cirvis universāls / Kirves / Чук - брадва / Čekić-Sjekira / Sekira / Πελέκι γενικής χρήσης / Hacha universal / Accetta universale / Machada universal / Merlin universal / Universele handbijl

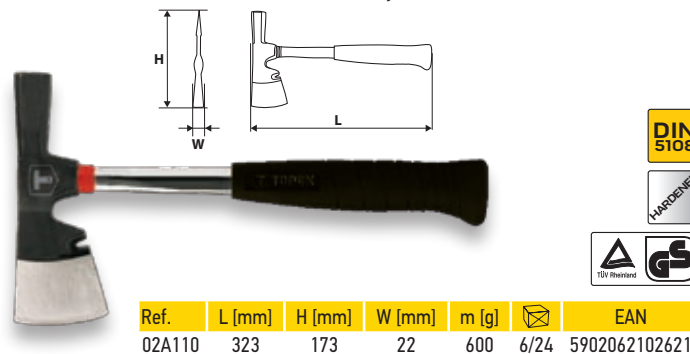

Ref.	L [mm]	H [mm]	W [mm]	m [g]	⊠	EAN
02A110	323	173	22	600	6/24	5902062102621

MŁOTEK ŚLUSARSKI

Machinist hammer / Schlosserhammer / Молоток столярный / Молоток слюсарный / Kalapács / Zámečnické kladivo / Kladivo zámočnické / Kļučavničarsko kladivo / Plaktukas šaltkalviui / Āmurs atslēdznieka / Lukksephaamer / Чук / Bravarski čekić / Cekic / Σφυρί μεταλλοτεχνίτη / Martillo de cerrajero / Martello di fabbro / Martelo p. Fechos / Martelet de serrurier / Slijphamer

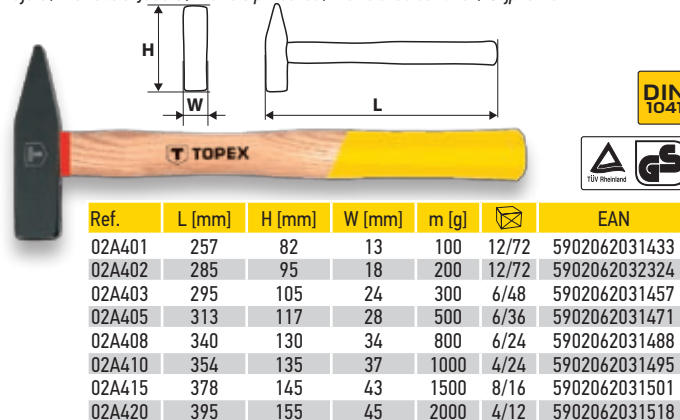

Ref.	L [mm]	H [mm]	W [mm]	m [g]	⊠	EAN
02A401	257	82	13	100	12/72	5902062031433
02A402	285	95	18	200	12/72	5902062032324
02A403	295	105	24	300	6/48	5902062031457
02A405	313	117	28	500	6/36	5902062031471
02A408	340	130	34	800	6/24	5902062031488
02A410	354	135	37	1000	4/24	5902062031495
02A415	378	145	43	1500	8/16	5902062031501
02A420	395	155	45	2000	4/12	5902062031518

MŁOTEK ŚLUSARSKI

Machinist hammer / Schlosserhammer / Молоток столярный / Молоток слюсарный / Kalapács / Zámečnické kladivo / Kladivo zámočnické / Kļučavničarsko kladivo / Plaktukas šaltkalviui / Āmurs atslēdznieka / Lukksephaamer / Чук / Bravarski čekić / Cekic / Σφυρί μεταλλοτεχνίτη / Martillo de cerrajero / Martello di fabbro / Martelo p. Fechos / Martelet de serrurier / Slijphamer

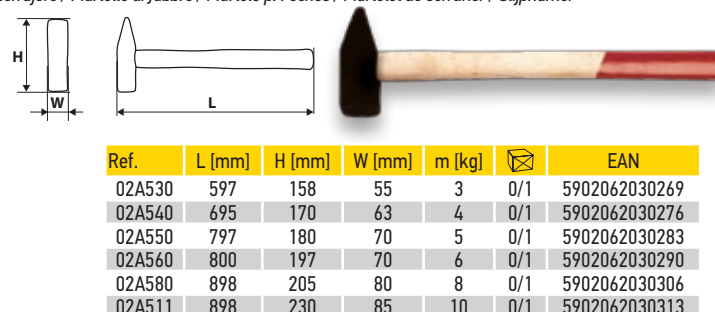

Ref.	L [mm]	H [mm]	W [mm]	m [kg]	⊠	EAN
02A530	597	158	55	3	0/1	5902062030269
02A540	695	170	63	4	0/1	5902062030276
02A550	797	180	70	5	0/1	5902062030283
02A560	800	197	70	6	0/1	5902062030290
02A580	898	205	80	8	0/1	5902062030306
02A511	898	230	85	10	0/1	5902062030313

MŁOTEK KAMIENIARSKI

Stonning hammer / Steinmetzhammer / Киянка / Молоток мулярський / Kötörő kalapács / Ciocan de pietrar / Aktenskaldžio plaktukas / Aktens apdares āturs / Műürsevasar / Каменарски чук / Zidarski čekić / Zidarski čekić / Ξιλόσφυρο / Martillo de cantero / Mazzetta / Martelo p. Pedras / Martelo à taille de pierres / Steenhamer

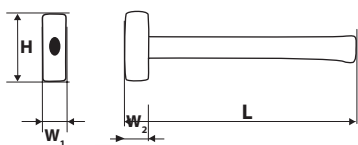

Ref.	W ₁ x W ₂ [mm]	H [mm]	L [mm]	m [kg]	☒	EAN
02A504	64 x 63	150	700	4	1/1	5902062025043
02A506	75 x 70	170	800	6	1/1	5902062025067
02A508	78 x 85	180	900	8	1/1	5902062025081

MŁOTEK KAMIENIARSKI

Stonning hammer / Steinmetzhammer / Киянка / Молоток мулярський / Kötörő kalapács / Ciocan de pietrar / Aktenskaldžio plaktukas / Aktens apdares āturs / Műürsevasar / Каменарски чук / Zidarski čekić / Zidarski čekić / Ξιλόσφυρο / Martillo de cantero / Mazzetta / Martelo p. Pedras / Martelo à taille de pierres / Steenhamer

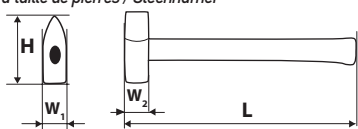

Ref.	W ₁ x W ₂ [mm]	H [mm]	L [mm]	m [kg]	☒	EAN
02A514	63 x 62	180	700	4	1/1	5902062025142
02A516	70 x 75	200	800	6	1/1	5902062025166
02A518	78 x 85	215	900	8	1/1	5902062025180

TRZONEK

Shank / Stiel / Рукоятка / Хвостовик / Nyél / Mânier / Násada / Tříň / Ročaj / Kotas / Spals / Vars / Цякъл / Držák / Drška, držalo / Χειρολαβή / Vástago / Manico / Cabo / Manche / Handvat



Ref.	do młotka [kg]	L [mm]	☒	EAN
02A082	0,5	320	0/50	5902062031792
02A083	1,0	360	0/50	5902062031808
02A084	2,0	400	0/50	5902062031815
02A085	3,0	500	0/50	5902062031822
02A086	4,0	600	0/50	5902062031839
02A087	5,0 - 6,0	700	0/50	5902062031846
02A088	8,0	800	0/50	5902062031853
02A089	10,0	900	0/50	5902062031860

MŁOTEK SPAWALNICZY

Welding hammer / Schweißerhammer / Молоток сварочный / Молоток зварювальний / Salakverőkalapács / Ciocan lucrări sudare / Svářečské kladívko / Kladívko zváračské / Varilno kladivo / Plaktukas suvirintojuji / Āmurs metinātāja / Keevitushaamer / Чук за заварчици / Čekić za varioce / Čekić / Σφυρί συγκολλητού / Martillo de soldador / Martello per saldatura / Martelo p. Soldagem / Martelet de soudure / Lashamer

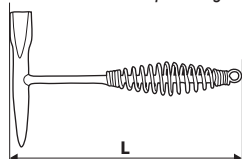
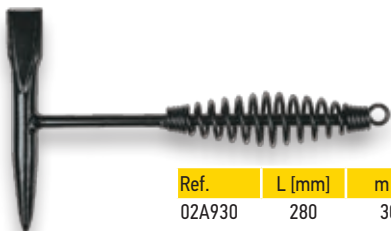

Ref.	L [mm]	m [g]	☒	EAN
02A930	280	300	0/12	5902062031662

MŁOTEK DREWNIANY

Wooden hammer / Holzhammer / Киянка деревянная / Молоток дерев'яний / Fakalapács / Ciocan din lemn / Dřevěné kladívko / Kladivo drevené hranaté / Kladivo / Medinis plaktukas / Āmurs koka / Puuhaamer / Чук дървен / Drveni čekić / Čekić / Ξύλινο σφυρί / Maza de madera / Martello di legno / Martelo de madeira / Martelet en bois / Houten hamer

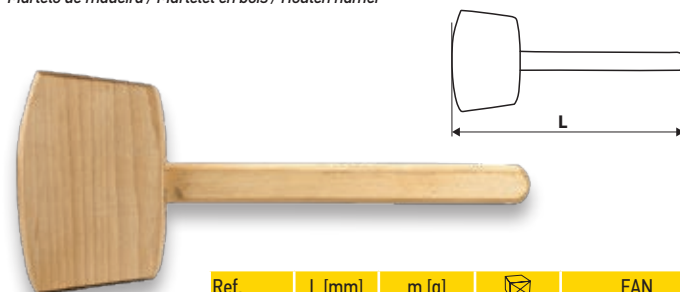

Ref.	L [mm]	m [g]	☒	EAN
02A050	315	500	4/36	5902062205001

MŁOTEK DREWNIANY

Wooden hammer / Holzhammer / Киянка деревянная / Молоток дерев'яний / Fakalapács / Ciocan din lemn / Dřevěné kladívko / Kladivo drevené hranaté / Kladivo / Medinis plaktukas / Āmurs koka / Puuhaamer / Чук дървен / Drveni čekić / Čekić / Ξύλινο σφυρί / Maza de madera / Martello di legno / Martelo de madeira / Martelet en bois / Houten hamer

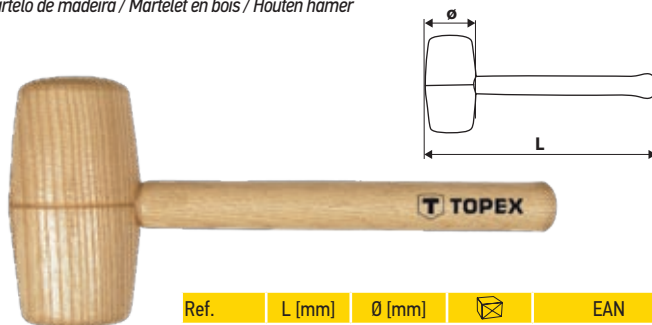

Ref.	L [mm]	Ø [mm]	☒	EAN
02A057	290	70	0/36	5902062205070

MŁOTEK GUMOWY

Rubber mallet / Gummihammer / Киянка резиновая / Молоток гумовий / Gumikalapács / Ciocan de cauciuc / Gumové kladívko / Kladivo gumové / Gumijasto kladivo / Skardnininko plaktukas / Āmurs skārdnīka / Kummihamer / Чук гумен / Gumeni čekić / Čekić / Λαστιχένια ματσόλα / Maza de goma / Martello di gomma / Martelo de borracha / Martelet en caoutchouc / Rubberen hamer

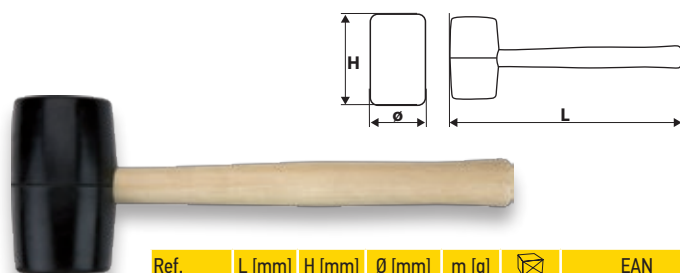

Ref.	L [mm]	H [mm]	Ø [mm]	m [g]	☒	EAN
02A343	305	88	50	340	12/48	5902062032201
02A344	340	95	58	450	6/36	5902062032218
02A345	337	116	63	680	6/24	5902062032225
02A347	338	120	72	900	6/24	5902062032232

MŁOTEK GUMOWY

Rubber mallet / Gummihammer / Киянка резиновая / Молоток гумовий / Gumikalapács / Ciocan de cauciuc / Gumové kladívko / Kladivo gumové / Gumijasto kladivo / Skardnininko plaktukas / Āmurs skārdnīka / Kummihamer / Чук гумен / Gumeni čekić / Čekić / Λαστιχένια ματσόλα / Maza de goma / Martello di gomma / Martelo de borracha / Martelet en caoutchouc / Rubberen hamer

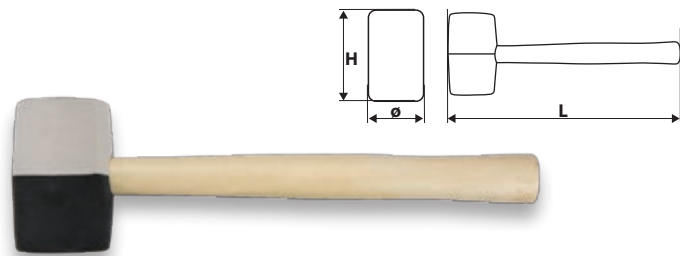

Ref.	L [mm]	H [mm]	Ø [mm]	m [g]	☒	EAN
02A354	338	97	58	450	6/36	5902062032270
02A355	337	116	63	680	6/24	5902062032287

MŁOTEK GUMOWY

Rubber mallet / Gummihammer / Киянка резиновая / Молоток гумовий / Gumikalapács / Ciocan de cauciuc / Gumové kladívko / Kladivo gumové / Gumijasto kladivo / Skardininko plaktukas / Āmurs skārdnieka / Kummihamer / Чук гумен / Gumeni čekić / Çekiç / Λαστιχένια ματσάλα / Maza de goma / Martello di gomma / Martelo de borracha / Martelet en caoutchouc / Rubberen hamer

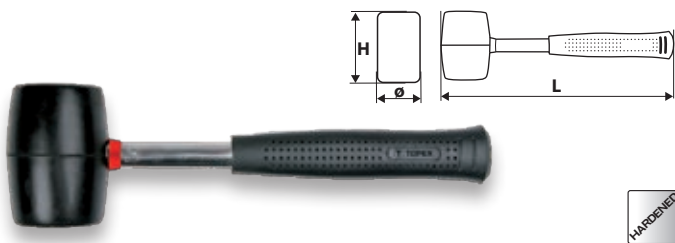

Ref.	L [mm]	H [mm]	Ø [mm]	m [g]	☒	EAN
02A305	325	96	65	450	6/36	5902062031402

KOMPLET BLACHARSKI

Car body repairing kit / Klempnersatz / Набор жестящика / Набор бляхарський / Karosszéria javító készlet / Set unelte repararea caroseriei automobil / Klempnířská souprava / Súprava klampiarska / Komplet kladiv / Skardininko komplektas / Skārdnieka komplekts / Tööriistad autokere parandamiseks / Чуковое комплекнт / Set čekića / Set çekica / Συλλογή εξαρτημάτων φανοποιείας / Juego de herramientas para hojalatería / Set per lattoniere / Conjunto p. chapas / Jeu d'outils de tôlerie / Staalplaat set



Ref.	☒	EAN
02A025	0/8	5902062030603

SIEKIERA

Axe / Axt / Topor / Сокира / Balta / Topor / Sekera / Sekera / Sekira / Kirvis / Cirvis / Kirves / Брадва / Sjekira / Sekira / Τσεκούρι / Hacha / Scure / Machado / Hache / Bijl

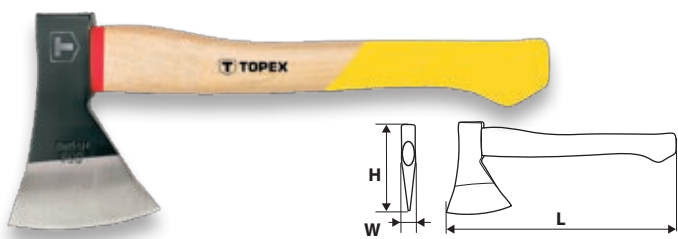

Ref.	L [mm]	H [mm]	W [mm]	m [g]	DIN	☒	EAN
05A136	360	150	20	600	5131	0/12	5902062103314
05A138	380	165	25	800	5131	0/6	5902062103321
05A140	610	180	30	1000	5131	0/6	5902062103338
05A142	710	200	35	1250	7294	0/6	5902062103345
05A146	810	215	40	1600	7294	0/6	5902062103352

SIEKIERA

Axe / Axt / Topor / Сокира / Balta / Topor / Sekera / Sekera / Sekira / Kirvis / Cirvis / Kirves / Брадва / Sjekira / Sekira / Τσεκούρι / Hacha / Scure / Machado / Hache / Bijl

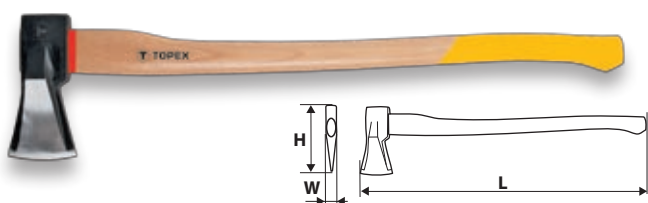

Ref.	L [mm]	H [mm]	W [mm]	m [g]	☒	EAN
05A148	800	200	70	2000	0/5	5902062032065

MŁOTO-SIEKIERA

Splitting maul / Hammer-Axt / Колун / Сокира з довшим ручк'ям / Hasító fejsze / Topor pentru despicat / Kladivová sekura / Kladivová sekera / Kladivo-sekira / Plaktukas-kirvis / Cirvis skaldīsanai / Haamriiga kirves / Чук-брадвачка / Çekiç sjekira / Çekiç-sekira / Τσεκούρι τεμαχισμού / Martillo-hacha / Martello-accetta / Martelo-serra / Hache-marteau / Hamer-bijl

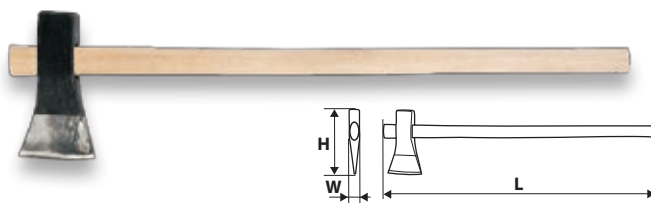

Ref.	L [mm]	H [mm]	W [mm]	m [g]	☒	EAN
05A527	900	220	55	3000	0/1	5902062103239

SIEKIERA

Axe / Axt / Topor / Сокира / Balta / Topor / Sekera / Sekera / Sekira / Kirvis / Cirvis / Kirves / Брадва / Sjekira / Sekira / Τσεκούρι / Hacha / Scure / Machado / Hache / Bijl



Ref.	L [mm]	H [mm]	W [mm]	m [g]	☒	EAN
05A200	360	150	20	600	0/24	5902062102751
05A201	380	165	25	800	0/12	5902062104519
05A203	610	180	30	1000	0/12	5902062104526

SIEKIERA

Axe / Axt / Topor / Сокира / Balta / Topor / Sekera / Sekera / Sekira / Kirvis / Cirvis / Kirves / Брадва / Sjekira / Sekira / Τσεκούρι / Hacha / Scure / Machado / Hache / Bijl

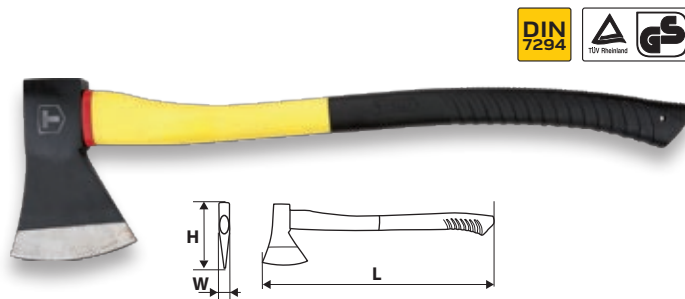

Ref.	L [mm]	H [mm]	W [mm]	m [g]	☒	EAN
05A202	710	200	35	1250	6/12	5902062104311
05A204	810	215	40	1500	0/6	5902062104533

KLIN DO ROZŁUPYWANIA DREWNA

Steel wedge / Holzspaltkeil / Клин для раскалывания дерева / Клин для деревини / Hasítóék / Papíř ořel / Klin na štípaní dřeva / Klin kálaci / Klin za sepljenje lesa / Pleiřtas medienai / Kılıs skaldīsanai / Teraskiil / Клин стоманен / Çelični klin / Celicni klin / Σφήνα για αποκοπή ξύλου / Cunha para partir maderas / Cuneo per tagliare legna / Cunha p. rachar madeira / Coin à bois / Houtwig



Ref.	m [g]	☒	EAN
05A320	2000	0/10	5902062662002

KILOF

Pick / Hacke / Кирка / Кирка / Csákány / sapă / Krompáč / Krompáč s rukoväťou / Kramp / Kirtiklis / Cirtnis / Kirka / Кирка / Kramp / Kramp / Açıva / Pico / Piccone / Picareta / Pic / Houweel

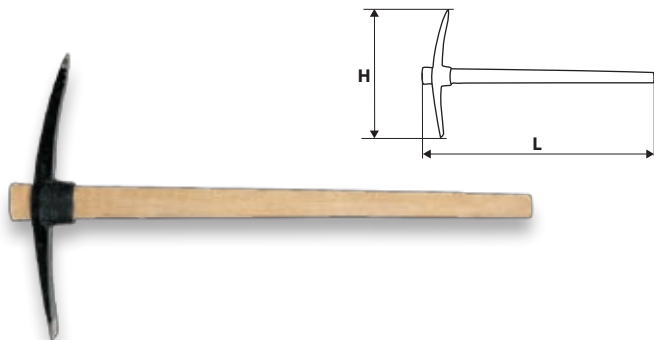

Ref.	L [mm]	H [mm]	W [mm]	m [g]	info	☒	EAN
05A525	-	510	60	2,5	kilof (obuch)	0/1	5902062103192
02A093	900	-	-	-	trzonek do kilofa	0/10	5902062032034

TRZONEK

Shank / Stiel / Рукоятка / Хвостовик / Nyél / Mânier / Násada / Tří / Ročaj / Kotas / Spals / Vars / Цокъл / Držak / Drška, držalo / Χειρολαβή / Vástago / Manico / Cabo / Manche / Handvat



Ref.	do siekier	L [mm]	☒	EAN
05A436	600g	360	0/1	5902062948700
05A450	800g	500	0/1	5902062948717
05A460	1000g	600	0/1	5902062948724
05A470	1250g	700	0/1	5902062948731

PIŁA DO METALU

Hacksaw frame / Metallsäge / Ножовка по металлу / Ножовка / Fémfűrész / Carcasă fereastră manual / Pila na kov / Pílka na kov / Žaga za kovino / Metalo pjúklas / Žągis metalam / Rauasae raam / Ножовка / Pila za metal / Testera za metal / Σιδηροπίοιο / Sierra para metal / Segá da metalli / Serra para metal / Scie à métal / Zaag voor metaal



Ref.	L [mm]	☒	EAN
10A145	300	0/36	5902062103277

PIŁA DO METALU

Hacksaw frame / Metallsäge / Ножовка по металлу / Ножовка / Fémfűrész / Carcasă fereastră manual / Pila na kov / Pílka na kov / Žaga za kovino / Metalo pjúklas / Žągis metalam / Rauasae raam / Ножовка / Pila za metal / Testera za metal / Σιδηροπίοιο / Sierra para metal / Segá da metalli / Serra para metal / Scie à métal / Zaag voor metaal

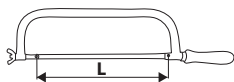

Ref.	L [mm]	☒	EAN
10A130	300	6/24	5902062102744

PIŁA DO METALU

Hacksaw frame / Metallsäge / Ножовка по металлу / Ножовка / Fémfűrész / Carcasă fereastră manual / Pila na kov / Pílka na kov / Žaga za kovino / Metalo pjúklas / Žągis metalam / Rauasae raam / Ножовка / Pila za metal / Testera za metal / Σιδηροπίοιο / Sierra para metal / Segá da metalli / Serra para metal / Scie à métal / Zaag voor metaal

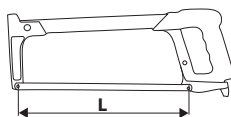

Ref.	L [mm]	☒	EAN
10A135	300	6/36	5902062100771

PIŁA DO METALU

Hacksaw frame / Metallsäge / Ножовка по металлу / Ножовка / Fémfűrész / Carcasă fereastră manual / Pila na kov / Pílka na kov / Žaga za kovino / Metalo pjúklas / Žągis metalam / Rauasae raam / Ножовка / Pila za metal / Testera za metal / Σιδηροπίοιο / Sierra para metal / Segá da metalli / Serra para metal / Scie à métal / Zaag voor metaal



Ref.	L [mm]	☒	EAN
10A225	250-300	12/48	5902062100153

UCHWYT DO BRZESZCZOTU

Hacksaw blade holder / Sägeblatthalterung / Держатель для полотна ножовки / Затискич до полотна ножовкових / Fémfűrész / Fixator pínză fereastră / Držák ostří / Držiak pilových plátkov, kov/drevo / Vpenjalo za rezilo / Rankena ašmenims / Žąga asmenų turėtuvas / Rauasaelehe hoidik / Ножовка / Držac Pile za metal-drevo / Drzac testere za metal / Λάμα για σιδηροπίοιο / Mango para hoja de sierra / Manico per lama / Suporte do Lâmina / Monture à lame de scie / Mesbladhouder



Ref.	L [mm]	☒	EAN
10A214	300	0/10	5902062103383

UCHWYT DO BRZESZCZOTU

Hacksaw blade holder / Sägeblatthalterung / Держатель для полотна ножовки / Затискич до полотна ножовкових / Fémfűrész / Fixator pínză fereastră / Držák ostří / Držiak pilových plátkov, kov/drevo / Vpenjalo za rezilo / Rankena ašmenims / Žąga asmenų turėtuvas / Rauasaelehe hoidik / Ножовка / Držac Pile za metal-drevo / Drzac testere za metal / Λάμα για σιδηροπίοιο / Mango para hoja de sierra / Manico per lama / Suporte do Lâmina / Monture à lame de scie / Mesbladhouder

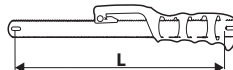

Ref.	L [mm]	☒	EAN
10A212	300	0/200	5902062103215

PIŁA DO METALU

Hacksaw frame / Metallsäge / Ножовка по металлу / Ножівка / Fémfűrész / Carcasa ferestrău manual / Pila na kov / Pílka na kov / Žaga za kovino / Metalo pjūklas / Žaģis metalām / Rauasae raam / Ножовка / Pila za metal / Testera za metal / Σιδηροπίλοιο / Sierra para metal / Segra per metallo / Serra p. metal / Scie à métal / Zaag voor metaal



Ref.	L [mm]	☒	EAN
10A115	150	6/72	5902062631657

BRZESZCZOT DO METALU

MORSE

Hacksaw blade / Metallsägeblatt / Полотно по металлу / Полотно ножівкове / Fémfűrészlap / Pīnzā ferāstrāu / Ostrī na kov / Pílka na kov / Rezilo za kovino / Geležte metalui / Žaģa asmenis metalām / Rauasaeleht / Луст за ножовка / List Pile / List testere / Λάμα για σιδηροπίλοιο / Hoja de sierra para metal / Lama per metalli / Lâmina p. metal / Lame de scie à métal / Lemmet voor metaal

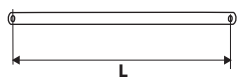

HSS BI-METAL

Ref.	L [mm]	TPI	info	☒	EAN
HBB1024	300	24	8% Cobalt	100/500	5902062103369
HBB122024	300	20/24	8% Cobalt	100/500	5902062103376

BRZESZCZOT DO METALU

Hacksaw blade / Metallsägeblatt / Полотно по металлу / Полотно ножівкове / Fémfűrészlap / Pīnzā ferāstrāu / Ostrī na kov / Pílka na kov / Rezilo za kovino / Geležte metalui / Žaģa asmenis metalām / Rauasaeleht / Луст за ножовка / List Pile / List testere / Λάμα για σιδηροπίλοιο / Hoja de sierra para metal / Lama per metalli / Lâmina p. metal / Lame de scie à métal / Lemmet voor metaal

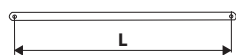

24TPI HSS BI-METAL

Ref.	L [mm]	W [mm]	☒	EAN
10A330	300	12,5	50/500	5902062101655

BRZESZCZOTY DO METALU

Blades for metal / Sägeblatt für Metall / Полотно по металлу / Полотна пильні по металу / Fémfűrészlapok / Pânze de ferăstraie pentru metale / Pilové listy na kov / Čepele na kov / Žagni listi za kovino / Pjūkliukai metalui / Metāla žaģis / Saeleht metalli saagimiseks / Лемму за метал / Pile za metal / Sečiva za metal / Приονόλαμες μετάλλου / Hojas de sierra para metal / Lama per metalli / Lâmina p. metal / Lame de scie à métal / Mesbladen voor metaal

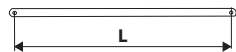

24TPI x2 HSS BI-METAL

Ref.	L [mm]	W [mm]	☒	EAN
10A331	300	12,5	50/500	590206221391

BRZESZCZOT DO METALU

Hacksaw blade / Metallsägeblatt / Полотно по металлу / Полотно ножівкове / Fémfűrészlap / Pīnzā ferāstrāu / Ostrī na kov / Pílka na kov / Rezilo za kovino / Geležte metalui / Žaģa asmenis metalām / Rauasaeleht / Луст за ножовка / List Pile / List testere / Λάμα για σιδηροπίλοιο / Hoja de sierra para metal / Lama per metalli / Lâmina p. metal / Lame de scie à métal / Lemmet voor metaal

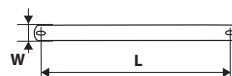

Ref.	L [mm]	W [mm]	info	☒	EAN
10A335	300	25	dwustronny, 5 szt.	1/50	5902062100177
10A333	300	25	dwustronny, 24 szt.	1/24	5902062104540
10A332-72	300	25	dwustronny, 72 szt.	1/10	5902062104571

BRZESZCZOT DO METALU I DREWNA

Blade for metal and wood / Sägeblatt für Metall und Holz / Полотно по металлу и дереву / Полотно пильне по металу и дереву / Fém- és fafűrészlapok / Pânză de ferăstraie pentru metale și lemn / Pilové list na kov a drevo / Čepele na kov a drevo / Žagni list za kovino in les / Pjūkliukas metalui ir medžiui / Metāla un koksnes žaģis / Saeleht metalli ja puidu saagimiseks / Лемму за метал и дръвесина / Pile za metal i drvo / Sečiva za metal i drvo / Приονόλαμα μετάλλου και ξύλου / Hoja de sierra para metal y madera / Lama per metallo e legno / Lâminas p. metal e madeira / Lames de scie à métal et à bois / Mesblad voor metaal en hout

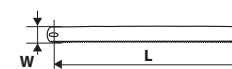

Ref.	L [mm]	W [mm]	info	☒	EAN
10A336	300	25	kpl. 5szt.	1/50	5902062104557
10A338	300	25	kpl. 24szt.	1/24	5902062104564
10A337-72	300	25	kpl. 72szt.	1/10	5902062104588

BRZESZCZOT WOLFRAMOWY

Tungsten carbide tipped wiresaw / Wolframsägeblatt / Полотно вольфрамовое / Полотно ножівкове вольфрамовое пласце / Vágósál / Ferāstrāu din sirmă de carbid de wolfram / Volframový pilový list / Plátok tvrdokovové na keramiku / Volframovo rezilo / Ašmenys volframiniai / Volframa asmenis / Volfram-karbiidotsaga kaabliõikur / Луст за рязане / žica za pilu za pločice / Žica za testeru za pločice / Κοπήρες καρβιδίου Tungsten / Hoja cilíndrica de tungsteno / Lama di tungsteno / Lâmina / Lame de scie en tungstène / Wolfram lemmet



Ref.	L [mm]	W [mm]	☒	EAN
16B414	300	25	0/100	5902062091864

PIŁA PŁATNICA

Hand saw / Fuchsschwanzsäge / Пила-ножовка / Ножівка / Kézifűrész / Ferestrău manual / Pílka ocaska / Pílka ručná / Ročna žaga / Pjūklas medžiui / Žaģis kokam / Käsisaag / Τριων / Pila ručna / Testera ručna / Ξυγάτα / Serrucho de carpintero / Segra manuale / Serra / Scie égoine / Handzaag

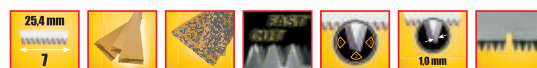

Ref.	L [mm]	☒	EAN
10A441	400	10/60	5902062103390
10A446	450	10/40	5902062103406
10A451	500	10/40	5902062103413

PIŁA PŁATNICA

Hand saw / Fuchsschwanzsäge / Πυλα-νοχσωνη / Ножовка / Kézifűrés / Ferestrău manual / Pilka ocaska / Pilka ručná / Ročna žaga / Pjūklas medžiui / Zāģis kokam / Käsisaag / Τριων / Pila ručna / Testera rucna / Ξεγάτσα / Serrucho de carpintero / Segá manuale / Serra / Scie égoine / Handzaag

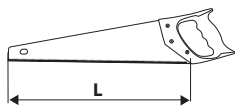

Ref.	L [mm]	⊠	EAN
10A440	400	10/60	5902062647405
10A445	450	10/40	5902062647450
10A450	500	10/40	5902062647504
10A453	560	10/40	5902062104502



PIŁA PŁATNICA

Hand saw / Fuchsschwanzsäge / Πυλα-νοχσωνη / Ножовка / Kézifűrés / Ferestrău manual / Pilka ocaska / Pilka ručná / Ročna žaga / Pjūklas medžiui / Zāģis kokam / Käsisaag / Τριων / Pila ručna / Testera rucna / Ξεγάτσα / Serrucho de carpintero / Segá manuale / Serra / Scie égoine / Handzaag

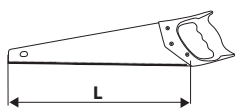

Ref.	L [mm]	⊠	EAN
10A442	400	10/60	5902062104472
10A447	450	10/40	5902062104489
10A452	500	10/40	5902062104496



PIŁA DO BETONU KOMÓRKOWEGO

Cellular concrete saw / Säge für Zellenbeton / Ножовка для пеноблоков / Ножовка по газобетону / Pórusbeton fűrés / Ferestrău pentru beton celular (BCA) / Pila na pórobeton / Pilka na komórkový beton / Žaga za čelični beton / Pjūklas akytam betonui / Gāzbetonabetaņa zāģis / Saag kergbetooni saagimiseks / Τριων за клетъчен бетон / Pila za betonske blokice / Testera za čelijski beton / Πριόνι ελαφρού μπετού / Sierra para bloques de hormigón celular / Segá per calcestruzzo cellulare / Serra p. Betão / Scie pour béton poreux / Zaag voor celbetonblokken

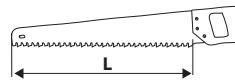

Ref.	L [mm]	⊠	EAN
10A760	600	12/48	5902062646170

PIŁA DO BETONU KOMÓRKOWEGO

Cellular concrete saw / Säge für Zellenbeton / Ножовка для пеноблоков / Ножовка по газобетону / Pórusbeton fűrés / Ferestrău pentru beton celular (BCA) / Pila na pórobeton / Pilka na komórkový beton / Žaga za čelični beton / Pjūklas akytam betonui / Gāzbetonabetaņa zāģis / Saag kergbetooni saagimiseks / Τριων за клетъчен бетон / Pila za betonske blokice / Testera za čelijski beton / Πριόνι ελαφρού μπετού / Sierra para bloques de hormigón celular / Segá per calcestruzzo cellulare / Serra p. Betão / Scie pour béton poreux / Zaag voor celbetonblokken

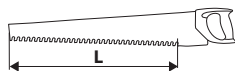

Ref.	L [mm]	⊠	EAN
10A761	600	6/12	5902062646187

PIŁA GRZBIETNICA

Back saw / Rückensäge / Ножовка пазовочная / Ножовка пазовочна / Illesztőfűrés / Ferestrău / Pilka hřbetovka / Pila çarpovka / Lisičji rep / Pjūklas / Zāģis lenķiem / Käsisaag / Τριων πασάτεμ / Pila ručna / Testera rucna / Φαλσοπριόνιο / Serrucho de costilla / Segá per tenani / Serra de costado / Scie à dos / Rugzaag

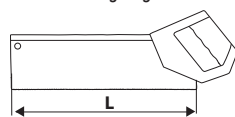

Ref.	L [mm]	info	⊠	EAN
10A703	300	9TPI	10/40	5902062101358
10A706	350	13TPI	10/40	5902062103185



PIŁA OTWORNICZA

Compass saw / Stichsäge / Ножовка узкая / Сучкоріз / Kiszűrófűrés / Ferestrău de traforaj / Pilka děrovka / Pilka zlodejka / Ozka žaga / Pjūklas angoms / Zaru zāģis / Sirkelsaag / Τριων ομοσπαρски / Pila uska / Testera uska / Πριόνι για ξύλο / Serrucho de punta / Traforatrice / Serra p. recortes / Scie à guichet / Gatenzaag

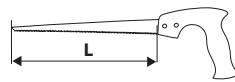

Ref.	L [mm]	⊠	EAN
10A723	300	0/125	5902062101303



NÓŻ DO WEŁNY MINERALNEJ

Knife for mineral wool / Messer zum Schneiden von Mineralwolle / Нож для минеральной ваты / Нож для минеральной ваты / Asványgyapot vágó kés / Cuiț pentru vată de sticlă / Nůž na minerální vlnu / Nůž na minerálnu vlnu / Rezilo za mineralno volno / Peilis mineralinei vatai / Minerālvates nazis / Minerālvillanuga / Нож за минерална вата / Nož za mineralnu vunu / Nož za mineralnu vunu / Kόπητς πετροβάμβακα / Cuchillo para lana mineral / Faca para lã mineral / Caltello per lana di roccia / Couteau pour laine de verre / Mes voor mineral wool

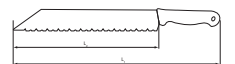

Ref.	L ₁ [mm]	L ₂ [mm]	⊠	EAN
17B900	480	335	10/60	5902062141156

PIŁA DO PŁYT GIPSOWO-KARTONOWYCH

Wallboard saw / Säge für Gipskartonplatten / Ножовка по гипсокартону / Ножовка по гипсокартону / Gipszcarton fűrés / Ferestrău pentru plăci gips carton / Pila na sadrocartón / Pilka na sadrocartón / Žaga za plošče karton-gips / Pjūklas gipso kartono plākštēms / Zāģis gipskartona plākšnēm / Kipsplaadsaag / Τριων за гипсово-картонени плочи / Pila za kartonsko-gipsane ploče / Testera za gipsano-kartonske ploče / Πριόνι γυψοσανίδας / Sierra para placas de yeso laminado / Segá per pannelli in cartongesso / Serra p. chapas de gesso e papelão / Scie à planches de plâtre / Zaag voor gipskartonplaten

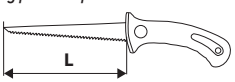

Ref.	L [mm]	info	⊠	EAN
10A717	150	piła	12/72	5902062103161
10A718	150	ostrze	0/200	5902062103178



PIŁA KĄTOWA

Mitre saw / Winkelsäge / Υελοπερζ / Стыцна / Gérláda / Ferestrău tăiere sub unghi / Úhlová pila / Pílka uhlavá / Kotna žaga / Pjūklas kampams / Leņķa zāģis / Saag / Машина за перъзу / Pila za sječenje pod kutom / Testera za secenje pod uglom / Φαλσοπίο / Sierra angular / Segá angolare / Serra de canto / Scie d'angle / Verstekzaag



Ref.	L [mm]	⊠	EAN
10A055	550	1/3	5902062100320

BRZESZCZOT DO PIŁY KĄTOWEJ

Mitre saw blade / Winkelsägeblatt / Πολυτομνο για υελοπερζα / Πολυτομνο до стыцна / Fűrészlap gérvágóhoz / Lamă ferăstrău pentru tăiere sub unghi / Ostrič do úhlové píly / Plátok pre pítku / Rezilni list za kotno žago / Pjūkliukas kampų pjovimo pjūkliai / Asmenis leņķa zāģim / Saeht / Пезерп / List Pile za pilu pod kutom / List testere za testeru pod uglom / Λάμα για φαλσοπίο / Hoja de sierra angular / Lama per la sega angolare / Lâmina / Lame de scie pour scie d'angle / Lemmet voor verstekzaag

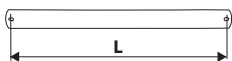

Ref.	L [mm]	W [mm]	⊠	EAN
10A065	550	45	1/50	5902062100344

PIŁA KABŁĄKOWA

Bow saw / Bogensäge / Ножовка лучковая / Ножовка лучкова / Fűrészkeretes / Ferestrău cu arc / Oblouková pila / Pílka ráťmová / Žaga lokarica / Pjūklas rēminis / Lokzāģis / Vibusaag / Τριουχ βιχνια / Pila za drvo / Testera za drvo / Τοξοπίο / Sierra de arco / Segá ad arco / Serra de arco / Scie à archet / Boogzaag

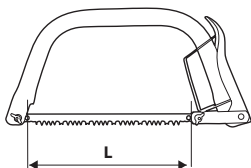

Ref.	L [mm]	∅ [mm]	info	⊠	EAN
10A903	300	15x30	z dwoma brzeszczotami	0/24	5902062102089
10A905	530	17x27		0/24	5902062101860
10A906	610	17x27		0/24	5902062101822
10A907	760	17x27		0/24	5902062101839

BRZESZCZOT DO PIŁY KABŁĄKOWEJ

Blade for bow saw / Sägeblatt für Bogensäge / Πολυτομνο για лучковой пилы / Πολυτομνο до пилки лучковой / Fűrészlap keretes fűrészhez / Pânză pentru ferăstrău cu ramă / Pilový list pro obloukovou pilu / Čepel' oblúkovéj píly / Žigni list za ločno žago / Geležište, lenktam pjūkliai / Lokzāģa asmens / Vibusae saeht / Лента за лъков трион / Ostrič za ručnu pilu / Sečiva za lučnu testeru / Приονόλαμα για τοξοειδές πριόνι / Hoja de sierra de arco / Lama per sega ad arco / Lâmina p. Serra / Lame de scie pour scie à archet / Mesblad voor boogzaag

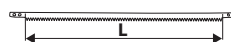

Ref.	L [mm]	⊠	EAN
10A915	530	0/240	5902062101938
10A916	610	0/240	5902062101945
10A917	760	0/240	5902062101952

BRZESZCZOT DO PIŁY KABŁĄKOWEJ

Blade for bow saw / Sägeblatt für Bogensäge / Πολυτομνο για лучковой пилы / Πολυτομνο до пилки лучковой / Fűrészlap keretes fűrészhez / Pânză pentru ferăstrău cu ramă / Pilový list pro obloukovou pilu / Čepel' oblúkovéj píly / Žigni list za ločno žago / Geležište, lenktam pjūkliai / Lokzāģa asmens / Vibusae saeht / Лента за лъков трион / Ostrič za ručnu pilu / Sečiva za lučnu testeru / Приονόλαμα για τοξοειδές πριόνι / Hoja de sierra de arco / Lama per sega ad arco / Lâmina p. Serra / Lame de scie pour scie à archet / Mesblad voor boogzaag

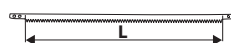

Ref.	L [mm]	⊠	EAN
10A925	530	0/240	5902062101884
10A926	610	0/240	5902062101891
10A927	760	0/240	5902062101907

SKRZYŃKA UCIOSOWA

Mitre box / Schneidschablone / Стыцна / Cтыцно / Gérláda / Îmbinare înclinată lem / Pokosnice / Vodítko ukosové / Jeralni predalčnik / Lovelis kampams pjauti / Trafarete leņķa zāģim / Nurgalōikuskast / Пазвaмен / Šablona za kutove / Ger / Φαλσοκοῦτι / Guía de sierra / Maschera per giunti ad angolo / Caixa / Boîte de coupe / Houten kist

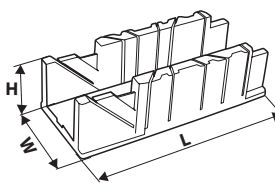

Ref.	L [mm]	W [mm]	H [mm]	⊠	EAN
10A840	212	42	44	0/50	5902062103031
10A842	233	53	56	0/50	5902062103048
10A843	250	65	60	0/50	5902062103208
10A844	295	80	70	0/50	5902062103055
10A846	320	120	75	0/50	5902062103062

SKRZYŃKA UCIOSOWA

Mitre box / Schneidschablone / Стыцна / Cтыцно / Gérláda / Îmbinare înclinată lem / Pokosnice / Vodítko ukosové / Jeralni predalčnik / Lovelis kampams pjauti / Trafarete leņķa zāģim / Nurgalōikuskast / Пазвaмен / Šablona za kutove / Ger / Φαλσοκοῦτι / Guía de sierra / Maschera per giunti ad angolo / Caixa / Boîte de coupe / Houten kist

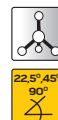
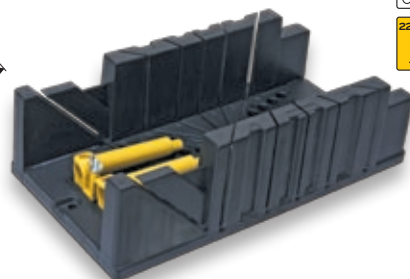
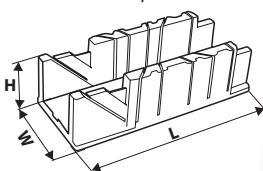

Ref.	L [mm]	W [mm]	H [mm]	info	⊠	EAN
10A848	320	120	75	z zaciskami	0/50	5902062103079

SKRZYŃKA UCIOŚOWA

Mitre box / Schneidschablone / Стысно / Стысно / Gértáda / Ímbinare ínclinatá lemn / Pokosnice / Vodítko ukosové / Jeralni predalčnik / Lovelis kampams pjauti / Trafarete lenča zăgim / Nurgaláikuskast / Пасвамен / Sablona za kutove / Ger / Φαλσοκούτι / Guía de sierra / Maschera per giunti ad angolo / Caixa / Boîte de coupe / Houten kist

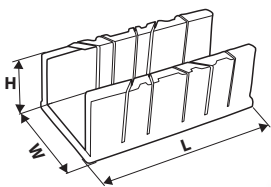

Ref.	L [mm]	W [mm]	H [mm]	☒	EAN
10A822	220	45	55	0/70	5902062101365
10A824	240	55	70	0/50	5902062101020
10A827	280	85	85	0/50	5902062202000

SKRZYŃKA UCIOŚOWA

Mitre box / Schneidschablone / Стысно / Стысно / Gértáda / Ímbinare ínclinatá lemn / Pokosnice / Vodítko ukosové / Jeralni predalčnik / Lovelis kampams pjauti / Trafarete lenča zăgim / Nurgaláikuskast / Пасвамен / Sablona za kutove / Ger / Φαλσοκούτι / Guía de sierra / Maschera per giunti ad angolo / Caixa / Boîte de coupe / Houten kist

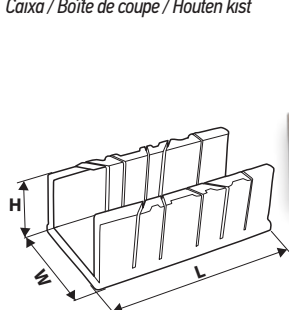

Ref.	L [mm]	W [mm]	H [mm]	☒	EAN
10A803	300	65	45	0/40	5902062100412

KIELNIA MURARSKA

Brick trowel / Maurerkelle / Кельма каменщица / Кельма мулярсъна / Kátmúveskanál / Mistrie / Zednická lžice / Keľňa murárska / Zidarska žlica / Mentelè mürininkui / Mürnieka kelle / Müürsepekellu / Зидарска мустрия / Zidarska lopatica / Zidarska mistrinja / Μυστί / Paleta de albañil / Cazzuola da muratore / Colher de pedreiro / Truelle de maçonage / Metseltroffel

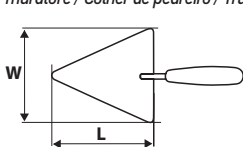

Ref.	L [mm]	W [mm]	☒	EAN
13A100	180	180	0/50	5902062091918

KIELNIA MURARSKA

Brick trowel / Maurerkelle / Кельма каменщица / Кельма мулярсъна / Kátmúveskanál / Mistrie / Zednická lžice / Keľňa murárska / Zidarska žlica / Mentelè mürininkui / Mürnieka kelle / Müürsepekellu / Зидарска мустрия / Zidarska lopatica / Zidarska mistrinja / Μυστί / Paleta de albañil / Cazzuola da muratore / Colher de pedreiro / Truelle de maçonage / Metseltroffel

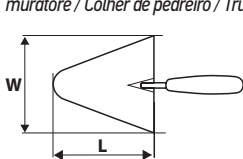

Ref.	L [mm]	W [mm]	☒	EAN
13A103	200	185	0/50	5902062092373

KIELNIA TRAPEZOWA

Trapezoidal trowel / Trapez-Maurerkelle / Мастерок / Кельма трапецевидна / Trapéz kátmúves kanál / Mistrie trapezoidálá / Lžice trapézová / Keľňa trapézová / Trapezasta žlica / Mentelè trapezcinè / Trapezveida kelle / Trapetskellu / Мустрия / Trapezasta lopatica / Trapezasta mistrinja / Μυστί / Παλετά αβαñιλ / Paleta de albañil trapezoidal / Cazzuola a punta quadra / Colher de pedreiro de trapézio / Truelle trapezoidale / Trapezium troffel

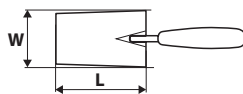

Ref.	L [mm]	W [mm]	☒	EAN
13A119	200	140	0/50	5902062092380

KIELNIA SZTUKATORSKA

Stucco trowel / Stuckateur-Kelle / Кельма штукатурная / Кельня штукатурна / Kátmúves kanál / Mistrie p/u petrar / Stukatérská lžice / Keľňa lichobežníková nerez / Zidarska žlica za štukature / Mentelè tinkuotojui / Kelle armetēja / Kipskrohvikellu / Мустрия / Žlica / Mistrinja / Σπάτουλα στόκου / Paleta de albañil trapezoidal / Cazzuola di stuccatore / Colher de pedreiro para rematar / Truelle de stucage / Stukadoortroffel

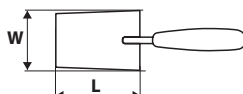

Ref.	L [mm]	W [mm]	☒	EAN
13A800	160	80	0/50	5902062091635

KIELNIA SZTUKATORSKA

Stucco trowel / Stuckateur-Kelle / Кельма штукатурная / Кельня штукатурна / Kátmúves kanál / Mistrie p/u petrar / Stukatérská lžice / Keľňa lichobežníková nerez / Zidarska žlica za štukature / Mentelè tinkuotojui / Kelle armetēja / Kipskrohvikellu / Мустрия / Žlica / Mistrinja / Σπάτουλα στόκου / Paleta de albañil trapezoidal / Cazzuola di stuccatore / Colher de pedreiro para rematar / Truelle de stucage / Stukadoortroffel

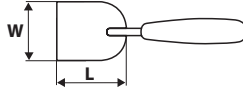

Ref.	L [mm]	W [mm]	☒	EAN
13A805	100	60	0/50	5902062091642
13A810	110	80	0/50	5902062091659

KIELNIA SZTUKATORSKA

Stucco trowel / Stuckateur-Kelle / Кельма штукатурная / Кельня штукатурна / Kátmúves kanál / Mistrie p/u petrar / Stukatérská lžice / Keľňa lichobežníková nerez / Zidarska žlica za štukature / Mentelè tinkuotojui / Kelle armetēja / Kipskrohvikellu / Мустрия / Žlica / Mistrinja / Σπάτουλα στόκου / Paleta de albañil trapezoidal / Cazzuola di stuccatore / Colher de pedreiro para rematar / Truelle de stucage / Stukadoortroffel

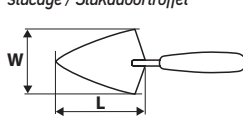

Ref.	L [mm]	W [mm]	☒	EAN
13A815	140	80	0/50	5902062091666

KIELNIA SZTUKATORSKA

Stucco trowel / Stuckateur-Kelle / Кельма штукатурная / Кельня штукатурна / Kámtúves kanál / Mistrie p/u petrar / Štukatérská lžice / Keľňa lichobežníková nerez / Židarska žlica za štukature / Mentelè tinkuotojui / Kelle armetèja / Kipskrohvikellu / Мустрия / Žlica / Mistrija / Σπάτουλα στόκου / Paleta de albañil trapezoidal / Cazzuola di stuccatore / Colher de pedreiro para rematar / Truelle de stucage / Stukadoortroffel

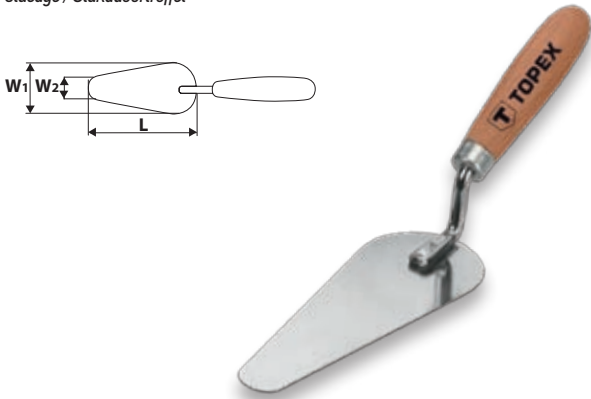

STAINLESS

Ref.	L [mm]	W1 [mm]	W2 [mm]	☒	EAN
13A820	160	55	20	0/50	5902062091673
13A825	160	20	55	0/50	5902062091680

KIELNIA SZTUKATORSKA

Stucco trowel / Stuckateur-Kelle / Кельма штукатурная / Кельня штукатурна / Kámtúves kanál / Mistrie p/u petrar / Štukatérská lžice / Keľňa lichobežníková nerez / Židarska žlica za štukature / Mentelè tinkuotojui / Kelle armetèja / Kipskrohvikellu / Мустрия / Žlica / Mistrija / Σπάτουλα στόκου / Paleta de albañil trapezoidal / Cazzuola di stuccatore / Colher de pedreiro para rematar / Truelle de stucage / Stukadoortroffel

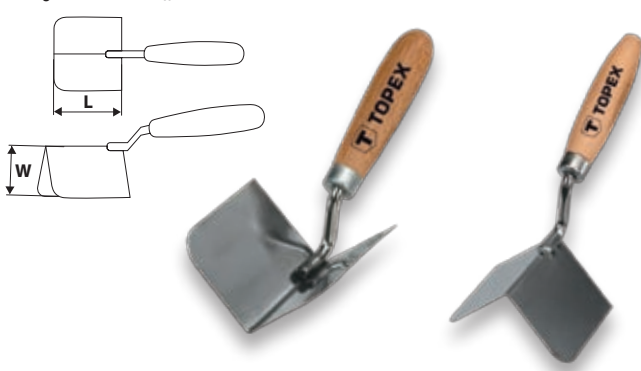

STAINLESS

Ref.	L [mm]	W [mm]	info	☒	EAN
13A830	80	60	wewnętrzna	0/50	5902062091697
13A835	80	60	zewnętrzna	0/50	5902062091703

KIELNIA DO FUGOWANIA

Trowel / Fugenkelle / Кельма для расшивки швов / Кельня до розшивання швів / Fugázókanál / Mistrie p/u petrar / Špárovačka / Keľňa špárovacia nerez / Židarska žlica za fugiranje / Mentelè / Kelle šivem / Kellu / Мустрия / Žlica / Mistrija / Espátula para juntas / Cazzuola per giunture / Colher de pedreiro para pôr junta / Truelle pour joints / Voegtroffel

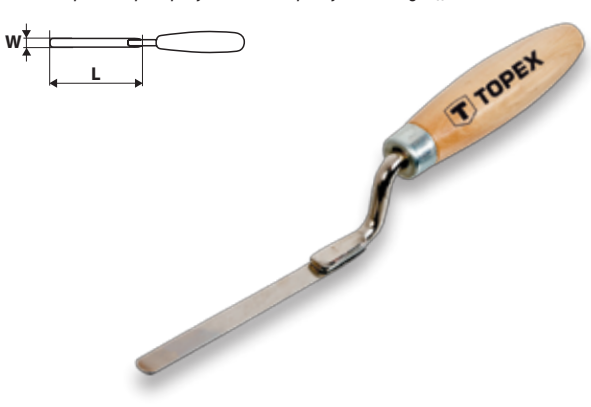

STAINLESS

Ref.	L [mm]	W [mm]	☒	EAN
13A572	150	8	0/1	5902062091932
13A574	150	10	0/1	5902062091949
13A576	150	12	0/1	5902062091956

KIELNIA DO BETONU

Trowel for concrete / Betonkelle / Кельма для кладки бетона / Кельма для бетону / Habarsteritò kanál pòrusbetonhoz / Mistrie pentru beton / Lžice na beton / Keľňa na betón / Žlica za beton / Glaistykè betonui / Betona kelle / Betoonikellu / Мустрия за бетон / Lopata za beton / Mistrija za beton / Μυστί μπετόυ / Llana para hormigón / Cazzuola per calcestruzzo / Colher de pedreiro p. Betão / Truelle pour béton / Troffel voor beton

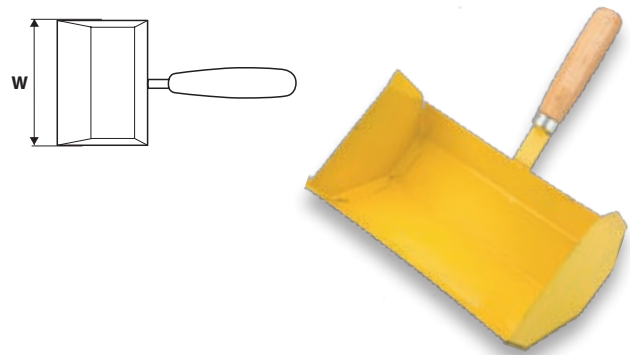

Ref.	W [mm]	☒	EAN
13A582	240	0/8	5902062092359

PACA DO ZACIERANIA

Plastering float / Reibebrett / Терка / Терпка / Simító / Drisčã de spãcluit / Hladitko / Hladidlo / Gladilka / Trintuvè / Rìve / Hajutuskelu / Маламашка / Plovak za brisanje / Glačalica za špahtlovanje / Σπάτουλα φινιρίσματος / Llana de relleño / Frattone per spianare / Desempenadeira para polir / Taloches à ègrenage / Plakspaan voor polijsten

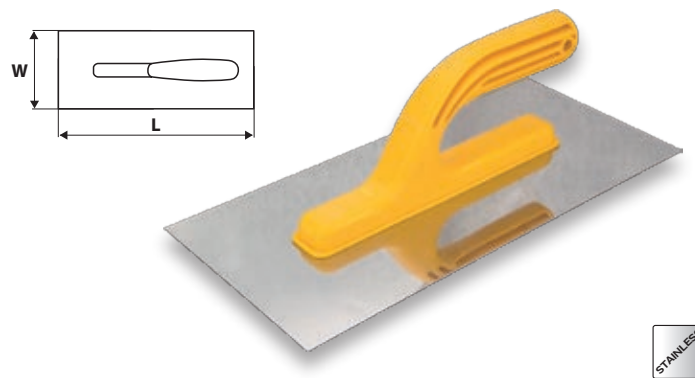

STAINLESS

Ref.	L [mm]	W [mm]	☒	EAN
13A228	280	130	0/40	5902062090478

PACA Z ZĘBAMI

Serrated float / Reibebrett mit Zähnen / Терка с зубьями / Терпка зубчата / Fogazott simító / Drisčã cu dinți / Hladitko zub / Hladidlo so zubami / Gladilka z zobmi / Dantya trintuvè / Rìve ar zobiem / Нартмашкелу / Назъбена маламашка / Зирчasti plovak / Glačalica sa zubima / Σπάτουλα χτένα / Talochas con peine / Frattone dentato / Desempenadeira com dentes / Taloches à dents / Plakspaan met vertanding

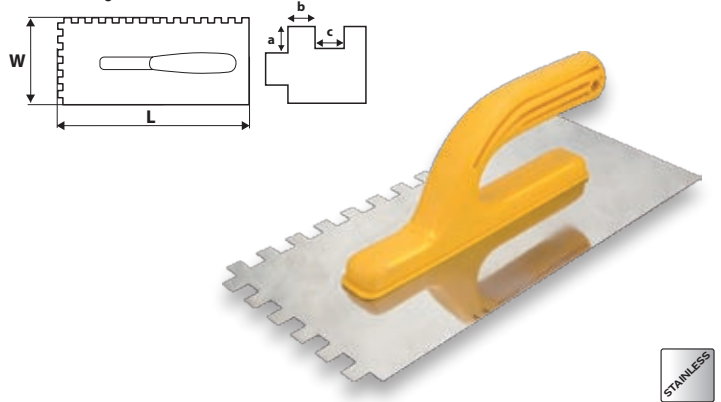

STAINLESS

Ref.	L [mm]	W [mm]	a x b x c [mm]	☒	EAN
13A284	280	130	4 x 4 x 4	0/40	5902062090485
13A286	280	130	6 x 6 x 6	0/40	5902062090492
13A288	280	130	8 x 8 x 8	0/40	5902062090508
13A290	280	130	10x10x10	0/40	5902062090515

PACA DO ZACIERANIA

Plastering float / Reibebrett / Терка / Терпка / Simitó / Driščă de spăcluit / Hladitko / Hladidlo / Gladilka / Trintuvė / Rive / Hajutuskellu / Маламашка / Plovak za brisanje / Glačalica za špahltovanje / Σπάτουλα φινιρίσματος / Llana de relleu / Frattone per spianare / Desempenadeira para polir / Talocha à égrenage / Plakspaan voor polijsten

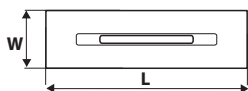

Ref.	L [mm]	W [mm]	☒	EAN
13A248	480	130	10/20	5902062091086
13A249	580	130	6/24	5902062092250
13A250	680	130	6/24	5902062092267

PACA

Float / Reibebrett / Терка / Терпка / Acélsimitó / Lopāčičă / Hladitko / Hladitka nerez / Gladilna žlica / Glaistykłė / Rīvdēlis / Ujuk / Маламашка / Gleter / Perdaska / Τριβίδι / Talocha / Pialletto / Desempenadeira / Taloches / Hoektraffel

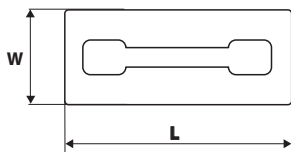

Ref.	L [mm]	W [mm]	info	☒	EAN
13A340	260	130	gladka	0/40	5902062091093

PACA Z GUMA

Float with rubber / Reibebrett mit Gummi / Терка с резиновым покрытием / Терпка з гумою / Gumis simitó / Driščă cu cauciuc / Hladitko s pryží / Hladidlo s gumou / Gladilka z gumo / Gumuota trintuvė / Rive ar gumijū / Kummiga kellu / Гумена маламашка / Plovak s gumom / Glačalica s gumom / Σπάτουλα φινιρίσματος με λάστικο / Llana con goma / Frattone con gomma / Desempenadeira com borracha / Taloches à caoutchouc / Plakspaan met rubber

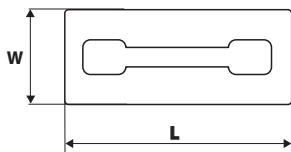

Ref.	L [mm]	W [mm]	grubość [mm]	info	☒	EAN
13A320	260	130	8	guma	0/30	5902062090539
13A321	260	130	4	guma	0/30	5902062208323

PACA Z GĄBKĄ GUMOWĄ

Float with rubber sponge / Reibebrett mit Gummischwamm / Терка с резиновой губной / Терпка з гумовою губною / Gumis szivacsos simitó / Driščă cu burete de cauciuc / Hladitko s pryžovou houbou / Hladidlo so špongiou gumové / Gladilka z gumijasto gobo / Trintuvė su gumine kempine / Rive ar gumijas sūkli / Kummikäsnağa kellu / Маламашка с гумена гъба / Plovak s gumenom spužvom / Glačalica sa gumenim sunderom / Σπάτουλα φινιρίσματος με ελαστικό σπόγγο / Talocha de plástico con esponja de goma / Frattone con spugna in gomma / Desempenadeira com esponja de borracha / Taloches à éponge en caoutchouc / Plakspaan met rubberen spons

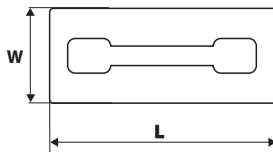

Ref.	L [mm]	W [mm]	grubość [mm]	info	☒	EAN
13A341	260	120	10	gąbka gumowa	0/30	5902062092298
13A342	260	120	18	gąbka gumowa	0/30	5902062092304

PACA Z GĄBKĄ

Float with sponge / Reibebrett mit Schwamm / Терка с губной / Терпка з губною / Szivacsos simitó / Driščă cu burete / Hladitko s houbou / Hladidlo so špongiou / Gladilka z gobo / Trintuvė su kempine / Rive ar sūkli / Käsnağa kellu / Маламашка с гъба / Plovak sa spužvom / Glačalica sa sunderom / Σπάτουλα φινιρίσματος με σπόγγο / Llana con esponja / Frattone con spugna / Desempenadeira com esponja / Taloches à éponge / Plakspaan met spons

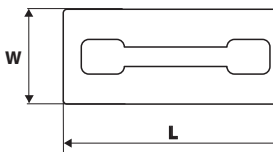

Ref.	L [mm]	W [mm]	info	☒	EAN
13A330	260	130	gąbka [25mm]	0/40	5902062090546

PACA Z GĄBKĄ TWARDA

Float with hard sponge / Reibebrett mit Schramm hart / Терка с твердой губной / Терпка з жорсткою губною / Keményszivacsos simitó / Driščă cu burete dur / Hladitko s tvrdou houbou / Hladidlo so špongiou tvrdé / Gladilka s tvrdou gobo / Trintuvė su kieta kempine / Rive ar cietu sūkli / Kőva käsnağa kellu / Маламашка с твърда гъба / Plovak s tvrdom spužvom / Glačalica sa tvrdim sunderom / Σπάτουλα φινιρίσματος με σκληρό σπόγγο / Llana con esponja blanda / Frattone con spugna dura / Desempenadeira com esponja dura / Taloches à éponge dure / Plakspaan met harde spons

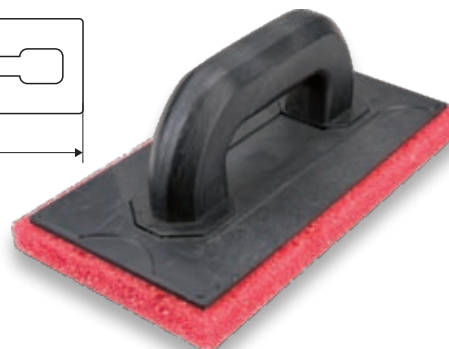
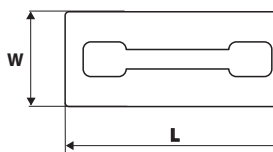

Ref.	L [mm]	W [mm]	info	☒	EAN
13A332	260	130	gąbka twarda	0/30	5902062092168

PACA Z GĄBKĄ MIĘKKĄ

Float with soft sponge / Reibebrett mit Schramm weich / Терка с мягкой губкой / Тертка з м'якою губкою / Puhaszivacsos simító / Driščă cu burete moale / Hladitko s měkkou houbou / Hladidlo so špongiou jemné / Gladilka z mehko gobo / Trintuvė su minkšta kempinė / Rive ar mīksto sūkli / Pehme käsnağa kellu / Μαλαμασκηνα с мекна гъба / Plovak s mekom spružvom / Glačalica sa mekim sunderom / Σπάτουλα φινιρίσματος με μαλακό σπόγγο / Llana con esponja dura / Frattone con spugna morbida / Desempenadeira com esponja mole / Talocha à éponge molle / Plakspraak met zachte spons

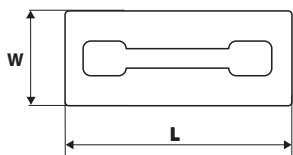

Ref.	L [mm]	W [mm]	info	☒	EAN
13A334	260	130	gąbka miękka	0/30	5902062092175

GĄBKA POROWATA

Porous sponge / Schwamm, porös / Губка пористая мягкая / Губка пориста / Pórusos szivacs / Burete poros / Pórovitá houba / Pórovitá špongia / Goba s porami / Korėta kempinė / Porainais sūklis / Poome käsna / Поречма гъба / Spružva s porama / Šupljikav sunder / Σπόγγος μαλακός πορώδης / Esponja con poros / Spugna porosa / Esponja com poros / Mousse poreuse / Poreus spons

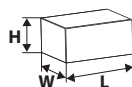

Ref.	L [mm]	W [mm]	H [mm]	info	☒	EAN
13A343	140	110	70	porowa miękka	0/40	5902062208286
13A344	140	110	70	hydro-chłonna	0/40	5902062208293

NARZĘDZIA RĘCZNE / BUDOWLANE

PACA Z GĄBKĄ GĘSTĄ

Float with dense sponge / Reibebrett mit Schramm dick / Терка с плотной губкой / Тертка з щільною губкою / Tömörszivacsos simító / Driščă cu burete dens / Hladitko s hustou houbou / Hladidlo so špongiou husté / Gladilka z gosto gobo / Trintuvė su tankios tekstūros kempinė / Rive ar blīvu sūkli / Tiheda käsnağa kellu / Μαλαμασκηνα с гъста гъба / Plovak s gustom spružvom / Glačalica sa gustim sunderom / Σπάτουλα φινιρίσματος με συμπαγή σπόγγο / Talocha de plástico con esponja densa / Frattone con spugna compatta / Desempenadeira com esponja densa / Talocha à éponge dense / Plakspraak met dichte spons

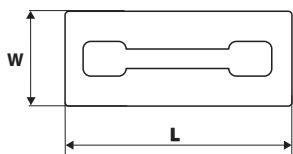

Ref.	L [mm]	W [mm]	info	☒	EAN
13A336	260	130	gąbka gęsta	0/30	5902062092182

PACA Z FILCEM

Float with felt / Reibebrett mit Filz / Терка с войлочным покрытием / Тертка з поєвстю / Filces simító / Driščă cu păslă / Hladitko s filcem / Hladidlo s filcom / Gladilka s filcem / Trintuvė su dirbtiniu veltniu / Rive ar tūbu / Flisiga kellu / Μαλαμασκηνα с филц / Plovak s filcom / Glačalica sa filcom / Σπάτουλα φινιρίσματος με κεταέ / Talocha con feltro / Frattone con feltro / Desempenadeira com feltro / Talocha à feutre / Plakspraak met vilt

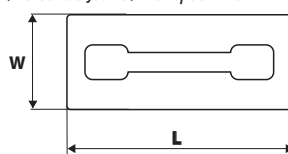

Ref.	L [mm]	W [mm]	grubość [mm]	info	☒	EAN
13A310	260	130	4	filc	0/30	5902062090522
13A311	260	130	8	filc	0/30	5902062092274

PACA Z GĄBKĄ HYDROCHŁONNĄ

Float with special sponge / Reibebrett mit Schramm wasserabsaugend / Терка влагопоглощающей губкой / Тертка з гігроскопічною губкою / Vízszívó szivacsos simító / Driščă cu burete hidroabsorbant / Hladitko s hydroabsorbčni houbou / Hladidlo hydro molitan / Gladilka z vodopojno gobo / Trintuvė su vandenį sugeriančia kempinė / Rive ar mitrumu užsūčošu sūkli / Vettimava käsnağa kellu / Μαλαμασκηνα с влагопогльщаща гъба / Plovak s hydroklomom spružvom / Glačalica sa upijajućim sunderom / Σπάτουλα φινιρίσματος με απορροφητικό σπόγγο / Talocha de plástico con esponja hidroabsorbente / Frattone con spugna idrofila / Desempenadeira com esponja absorvente / Talocha à éponge avide d'eau / Plakspraak met absorberende spons

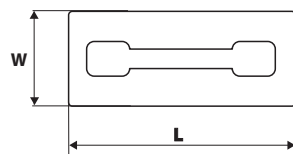

Ref.	L [mm]	W [mm]	info	☒	EAN
13A338	260	130	gąbka hydrochłonna	0/30	5902062092199

FILC DO PACY

Masonry felt / Filz für Reibebrett / Накладна войлочная для терки / Поєвсть до тертки / Filc simítóhoz / Păslă de driščă / Plst' pro hladitko / Filc do hladidla / Filc za gladilko / Dirbtinis veltnis trintuvei / Sūkļa tūba / Flis kellule / Φιλц за маλαμασκηνα / Filc za plovak / Filc za rad / Στρώμα κεταέ για σπάτουλα φινιρίσματος / Feltro para llana / Feltro per frattone / Feltro para desempenadeira / Feutre pour talocha / Vilt voor troffel

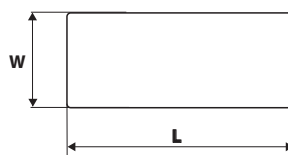

Ref.	L [mm]	W [mm]	grubość [mm]	☒	EAN
13A350	260	130	4	0/120	5902062090553
13A351	260	130	8	0/150	5902062092291

ZESTAW GLAZURNICZY

Glazing kit / Set zum Fliesenverlegen / Набор плиточника / Набор до укладання кахлів / Csempéző készlet / Garnitură de glazurare / Sada na obklady / Glazúrovacia súprava / Komplet za pešanje / Rinkinys plytelių klijavimui / Flizu licēja komplekts / Pliatimiskomplekt / Комплект за гледжосване / Set za glazuru / Pribor za glaziranje / Σετ για τοποθέτηση πλακιδίων / Juego para colocar azulejos / Completo per piastrelle / Kit gp. Azulejos / Jeu d'outils de carrelage / Glazuurset



Ref.	☒	EAN
13A339	0/1	5902062092335

PACA STYROPIANOWA

Polystyren float / Styroporreibrett / Терка пенополистироловая / Терка полістирольна / Simító hungarocell / Lopática polistiren / Polystyrenové hladítko / Hladítko polystyrénové / Gladilna žlica za stropor / Trintuvé glaistui / Rīvdēlis putuplasta / Ujuk (polüstīreēn) / Маламашка / Gladilo / Perdaska / Τριβίδι από πολυεστέρα / Talocha de polièstireno / Pialletto di polistirolo / Desempenadeira de polièstireno extruído / Talochè polystyrène / Polystyren traffel

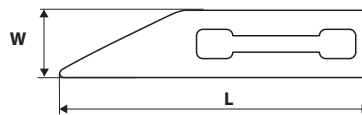

Ref.	L [mm]	W [mm]	☒	EAN
13A412	340	40	0/10	5902062208279

PACA STYROPIANOWA

Polystyren float / Styroporreibrett / Терка пенополистироловая / Терка полістирольна / Simító hungarocell / Lopática polistiren / Polystyrenové hladítko / Hladítko polystyrénové / Gladilna žlica za stropor / Trintuvé glaistui / Rīvdēlis putuplasta / Ujuk (polüstīreēn) / Маламашка / Gladilo / Perdaska / Τριβίδι από πολυεστέρα / Talocha de polièstireno / Pialletto di polistirolo / Desempenadeira de polièstireno extruído / Talochè polystyrène / Polystyren traffel

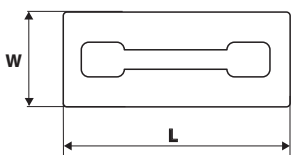

Ref.	L [mm]	W [mm]	☒	EAN
13A402	280	140	0/10	5902062090058
13A405	600	140	0/10	5902062090065
13A407	750	140	0/10	5902062090072
13A410	1000	140	0/10	5902062091338

SZPACHLA DO SZTABLATURY

Scraper / Gipsedelputzspachtel / Шпатель для венецианской штукатурки / Шерхебель / Felületssimító / Rázatóare / Špachtle na benátskou omítku / Špachtla štukatérská nerez / Strgalo / Glaistyklè / Špaktelis apnetumam / Kaabits / Шпакля / Fasadna Lopatica za kit / Strugac / Ξύστρα / Espátula para acabado de yeso / Spattola / Betumadeira / Spatule pour enduit de qualité / Plamuurmes voor pleisterwerk

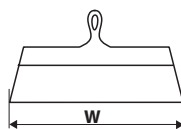

STAINLESS

Ref.	W [mm]	☒	EAN
13A515	150	0/10	5902062091765
13A520	200	0/10	5902062091772
13A525	250	0/10	5902062091789
13A530	350	0/5	5902062091314
13A545	450	0/5	5902062091321
13A560	600	0/5	5902062091574

PACA STYROPIANOWA

Polystyren float / Styroporreibrett / Терка пенополистироловая / Терка полістирольна / Simító hungarocell / Lopática polistiren / Polystyrenové hladítko / Hladítko polystyrénové / Gladilna žlica za stropor / Trintuvé glaistui / Rīvdēlis putuplasta / Ujuk (polüstīreēn) / Маламашка / Gladilo / Perdaska / Τριβίδι από πολυεστέρα / Talocha de polièstireno / Pialletto di polistirolo / Desempenadeira de polièstireno extruído / Talochè polystyrène / Polystyren traffel

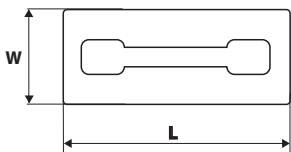

Ref.	L [mm]	W [mm]	☒	EAN
13A411	320	180	0/10	5902062208262

SZPACHLA MALARSKA

Scraper / Malerspachtel / Шпатель малярный / Шерхебель / Festékkaparó / Rázatóare / Malířská špachtle / Špachtla maliarska / Strgalo / Glaistyklè / Špaktelis / Kaabits / Шпакля / Lopatica za kit / Špachtla / Σπάτουλα οδοντωτή / Espátula de pintor / Spatola da pittore / Betumadeira p. Pintura / Spatule de peinture / Plamuurmes voor verfwerk



STAINLESS



Ref.	W [mm]	☒	EAN
18B604	40	12/120	5902062186041
18B605	50	12/120	5902062186058
18B606	63	12/120	5902062186065
18B607	75	12/120	5902062186072
18B610	100	12/120	5902062186102
18B612	125	12/120	5902062186126

SZPACHLA MALARSKA

Scraper / Malerspachtel / Шпатель малярный / Шерхобель / Festékkaparó / Rázátoare / Malířská špachtle / Špachtla maliarska / Strgalo / Glaistykè / Špaktelis / Kaabits / Шпакля / Lopatica za kit / Spachtla / Σπάτουλα οδοντωτή / Espátula de pintor / Spatola da pittore / Betumadeira p. Pintura / Spatule de peinture / Plamuurmes voor verfwerk

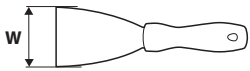

Ref.	W [mm]	☒	EAN
18B204	40	12/240	5902062120731
18B206	60	12/240	5902062120748
18B208	80	12/240	5902062120687
18B210	100	12/144	5902062120694
18B212	125	12/144	5902062120984
18B215	150	12/144	5902062120717

NARZĘDZIA RĘCZNE / BUDOWLANE

SZPACHLA MALARSKA

Scraper / Malerspachtel / Шпатель малярный / Шерхобель / Festékkaparó / Rázátoare / Malířská špachtle / Špachtla maliarska / Strgalo / Glaistykè / Špaktelis / Kaabits / Шпакля / Lopatica za kit / Spachtla / Σπάτουλα οδοντωτή / Espátula de pintor / Spatola da pittore / Betumadeira p. Pintura / Spatule de peinture / Plamuurmes voor verfwerk

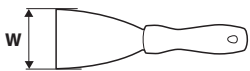

Ref.	W [mm]	☒	EAN
18B218	61	12/240	5902062120885

SZPACHLE MALARSKIE

Scraper set / Malerspachteln / Шпатели малярные / Шерхобели, набір / Festékkaparó / Rázátoare set / Malířské špachtle / Špachtle maliarske set / Garnitura strgal / Glaistykès / Špaktelu komplekts / Kaabitsakomplekt / Шпакли / špachtle / Spachtla set / Συλλογή από σπάτουλες οδοντωτές / Espátula de pintor / Spatola da pittore / Betumadeiras p. Pintura / Spatules de peinture / Verf-plamuurmessen



x4 STAINLESS

Ref.	W [mm]	☒	EAN
18B436	50, 80, 100, 120	10/200	5902062121790

ZDZIERAK DO STYROPIANU

Scraper for polypropylene board / Vorfeile für geschäumtes Polystyrol / Рубанок / Тертка до пінопласту / Ráspoly polisztirol habhoz / Gletiera pentru razuit / Hoblík na polystyrén / Rašpła na polystyrén / Strgalo za stiropor / Trintuvé puťy polistíroli / Évele / Vahtpolüsterooliraspel / Нож за зруба обработка на стиреопор / Odbojnik za stiropor / Rende za stiropor / Πλάνη / Escofina para poliestireno / Frattone per polistirolo / Lima grossa para poliestireno extruído / Rápe pour polystyrène / Krabber voor polystyreen

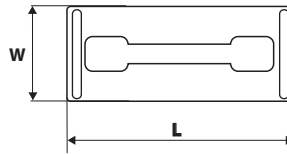

Ref.	L [mm]	W [mm]	☒	EAN
13A360	270	130	0/15	5902062091710

PLÓTNA ŚCIERNE

Abrasive cloths / Schleifklein / Шлифовальные полотна / Полотна наждакові / Csiszolóvászok / Pânze abrazive / Brusná plátina / Brúsné plátina / Brusna platna / Šlifaivo papieri / Slípēšanas audekls / Lihvriie / Абразивни платна / Brusna platna / Abrazivna platna / Χαρτιά λειανσης / Lijas de tela / Tessuti abrasivi / Tecidos abrasivos / Toiles abrasives / Schuurtextielen

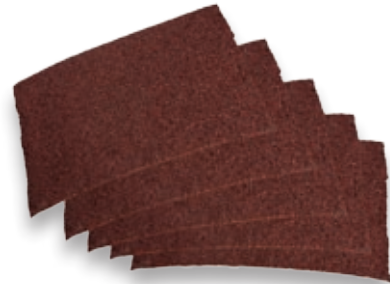

x10

Ref.	L x W [mm]	K	☒	EAN
08A420	230 x 280	36	100/300	5902062211002
08A422	230 x 280	40	100/300	5902062211019
08A424	230 x 280	60	100/300	5902062211026
08A426	230 x 280	80	150/450	5902062211033
08A428	230 x 280	100	150/450	5902062211040
08A430	230 x 280	120	150/450	5902062211057
08A432	230 x 280	180	200/600	5902062211064
08A434	230 x 280	220	200/600	5902062211071

SIATKI ŚCIERNE

Abrasive grids / Schleifgitter / Шлифовальная сетка / Сітки наждакові / Csiszolóháló / Plase abrazive / Brusné sítky / Brúsná mriežka / Brusne mreže / Šlifaivo tinkleliai / Slípēšanas tīkli / Lihvõrk / Абразивни мрежи / Brusne mreže / Abrazivne mreže / Πλέγμα λειανσης / Mallas de lijado / Reti abrasive / Redes abrasivas / Grilles abrasives / Schuurmetten

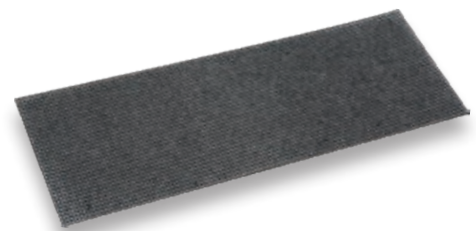

Ref.	L x W [mm]	K	N	☒	EAN
08A206	280 x 110	60	x50	0/27	5902062208125
08A208	280 x 110	80	x50	0/36	5902062208132
08A210	280 x 110	100	x50	0/36	5902062210807
08A212	280 x 110	120	x50	0/39	5902062208149
08A215	280 x 110	150	x50	0/42	5902062210814
08A218	280 x 110	180	x50	0/45	5902062210821
08A220	280 x 110	220	x50	1/57	5902062211477
08A240	280 x 110	240	x50	1/60	5902062211484

SIATKI ŚCIERNE

Abrasive grids / Schleifgitter / Шлифовальная сетка / Сітки наждакові / Csiszolóháló / Plase abrazive / Brusné sítky / Brúsna mrežka / Brusne mreže / Šljafavimo tinkleliai / Slipšanas tīkli / Lihnvõrk / Абразивни мрежи / Brusne mreže / Abrazivne mreže / Πλέγμα λείανσης / Mallas de lijado / Reti abrasive / Redes abrasivas / Grilles abrasives / Schuurmetten



Ref.	L x W [mm]	K	N	☒	EAN
08A606	280 x 110	60	x5	1/420	5902062211491
08A608	280 x 110	80	x5	1/440	5902062211507
08A610	280 x 110	100	x5	1/500	5902062211514
08A612	280 x 110	120	x5	1/520	5902062211521
08A615	280 x 110	150	x5	1/560	5902062211538
08A618	280 x 110	180	x5	1/600	5902062211545
08A620	280 x 110	220	x5	1/620	5902062211552
08A640	280 x 110	240	x5	1/640	5902062211569

BLOK ŚCIERNY

Sanding block / Schleifblock / Блок шлифовальный / Блок шлифовальный / Csiszolótuskó / Šlefuitoare de obezi / Brusný blok / Držiak brúsneho papiera / Brusni papir / Šljafavimo skriemulys / Smilšpapīra turētājs / Lihvimisklots / Шлауер / Držáč brusnog papira / Brusni papir u rolni / Τάκος λείανσης / Bloque abrasivo / Reti abrasive / Redes abrasivas / Grilles abrasives / Schuurblok

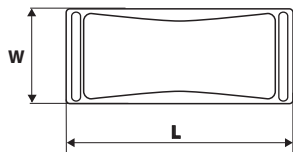

Ref.	L [mm]	W [mm]	☒	EAN
08A108	165	85	0/24	5902062206923
08A110	210	100	0/48	5902062206930

РАСА

Float / Reibbrett / Терка / Терка / Acélsimító / Lopőjtű / Hladitko / Hladitka nerez / Gladilna žlica / Glaistykļe / Rīvdēlis / Ujuk / Маламашка / Gleter / Perdaska / Τριβίδι / Talocha / Pialletto / Desempenadeira / Talochе / Hoektroffel

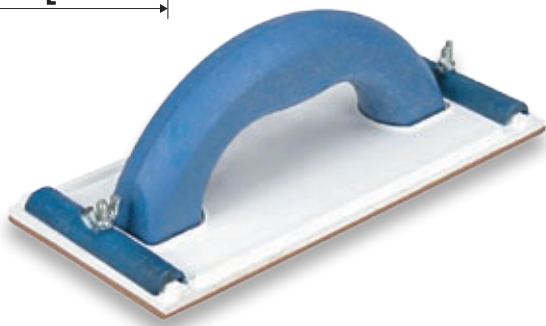
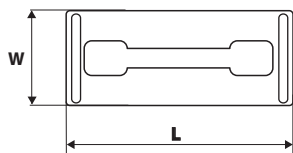

Ref.	L [mm]	W [mm]	☒	EAN
08A115	210	105	0/30	5902062091154

WIADRO

Bucket / Eimer / Ведро / Βίδρο / Habarcsvödör / Căldare / Kbelík / Vedro stavbárske / Vedro / Kibiras / Spainis / Ämber / Κοφα / Kanta / Kofa za malter / Κάδος / Cubo de obra / Secchio / Balde / Seau / Emmer



Ref.	V max [l]	☒	EAN
13A700	10	1/350	5902062091550

WIADRO BUDOWLANE

Bucket / Eimer für Bauzwecke / Ведро растворное / Βίδρο будівельне / Κότμύες vödör / Galeata pentru mortar/constructii / Stavební kbelík / Stavební vedierko / Zidarsko vedro / Kibiras / Būvniecības sprainis / Ehitusämber / Κοφα за приготвяне на разтвор / Zidarsko vjedro / Građevinska kofa / Κουβάς κονιάματος / Cubo de obra / Secchio per edilizia / Balde industrial / Seau de chantier / Bouwemmer



Ref.	V max [l]	☒	EAN
13A712	12	0/1	5902062091161
13A720	20	0/1	5902062091178

WIADRO BUDOWLANE

Bucket / Eimer für Bauzwecke / Ведро растворное / Βίδρο будівельне / Κότμύες vödör / Galeata pentru mortar/Constructii / Stavební kbelík / Stavební vedierko / Zidarsko vedro / Kibiras / Būvniecības sprainis / Ehitusämber / Κοφα за приготвяне на разтвор / Zidarsko vjedro / Građevinska kofa / Κουβάς κονιάματος / Cubo de obra / Secchio per edilizia / Balde industrial / Seau de chantier / Bouwemmer



Ref.	V max [l]	☒	EAN
13A716	16	0/1	5902062092427

WIADRO BUDOWLANE

Bucket / Eimer für Bauzwecke / Ведро растворное / Відро будівельне / Kőtűves vödör / Galeata pentru mortar/Constructii / Stavební kbelík / Stavební vedierko / Zidarsko vedro / Kibiras / Būvniecības spainis / Ehitusämber / Кофа за приготвяне на разтвор / Zidarsko vjedro / Građevinska kafa / Κουβιάς κονιάματος / Cubo de obra / Secchio per edilizia / Balde industrial / Seau de chantier / Bouwemmer



Ref.	V max [l]	☒	EAN
13A703	12	0/1	5902062091567

KASTRA BUDOWLANA

Mortar container / Mörtelkasten / Емкость растворная / Корито будівельне / Habarcsdézsa / Contaner p/u ceamur de constructie / Korba na maltu / Nádoba na maltu / Zidarska kanta / Statybiniai karučiai / Celtniecības toveris / Mördinöü / Леген строителен / Mortaljka / Gipsarski kontejner / Σκάφη οικοδομής / Cubo para mortero / Contenitore per edilizia / Tanque para construção / Auge de construction / Mortelbak



Ref.	V max [l]	☒	EAN
13A750	45	0/1	5902062091529
13A752	65	0/1	5902062092076
13A753	90	0/1	5902062092083

KASTRA BUDOWLANA

Mortar container / Mörtelkasten / Емкость растворная / Корито будівельне / Habarcsdézsa / Contaner p/u ceamur de constructie / Korba na maltu / Nádoba na maltu / Zidarska kanta / Statybiniai karučiai / Celtniecības toveris / Mördinöü / Леген строителен / Mortaljka / Gipsarski kontejner / Σκάφη οικοδομής / Cubo para mortero / Contenitore per edilizia / Tanque para construção / Auge de construction / Mortelbak



Ref.	V max [l]	☒	EAN
13A760	65	0/1	5902062091185
13A780	90	0/1	5902062091192

SZNUREK MURARSKI

Masonry line / Maurerschnur / Шнур разметочный каменщика / Шнур мулярський / Kőtűveszsinór / Linie zidire / Zednický provázek / Snúrka murárska / Zidarska vrv / Virvelé mürininkui / Mürnieka aukla / Müürinöör / Канан зидарски / Zidarski konac / Zidarski kanap / Σκοινί οικοδόμου / Cuerda de albañil / Corda di muratore / Corda p. Alvenaria / Fil de maçons / Metselsnoer



Ref.	L [m]	☒	EAN
13A920	100	25/100	5902062092434

SZNUREK MURARSKI

Masonry line / Maurerschnur / Шнур разметочный каменщика / Шнур мулярський / Kőtűveszsinór / Linie zidire / Zednický provázek / Snúrka murárska / Zidarska vrv / Virvelé mürininkui / Mürnieka aukla / Müürinöör / Канан зидарски / Zidarski konac / Zidarski kanap / Σκοινί οικοδόμου / Cuerda de albañil / Corda di muratore / Corda p. Alvenaria / Fil de maçons / Metselsnoer



Ref.	L [m]	☒	EAN
13A905	50	20/140	5902062091888
13A910	100	20/80	5902062091895

ŻYŁKA MURARSKA

Masonry line / Maurerleine / Леска разметочная каменщика / Жилка мулярський / Kőtűveszsinór / Linie zidire / Zednická šnúra / Lanko murárske / Zidarska vrv / Valas mürininkui / Mürnieka stieple / Müürinöör / Зидарско въже / Zidarski konac / Zidarski kanap / Λασπένιο λουράκι οικοδόμου / Hilo de nilón / Filo di muratore / Linha para construção / Fil de maçon / Metselknijlpin



Ref.	L [m]	Ø [mm]	☒	EAN
13A915	100	1	20/120	5902062091901

OŁÓWEK STOLARSKI

Carpenter's pencil / Tischlerstift / Карандаш столярный / Олівець столярний / Ácsceruza / Creion lăcătuș montor / Tesařská tužka / Ceruzka stolárska / Tesarski svinčnik / Stalius pieštukas / Zimulis galdnieka / Puuseparliats / Molus / Olovka za majstore / Olovka za majstore / Μολύβι ξυλουργού / Lápiz de carpintero / Matita da carpentiere / Lápiz p. Madeira / Crayon de menuisier / Timmermanspotlood



Ref.	L [mm]	☒	EAN
14A800	240	144/1008	5902062121707

OŁÓWEK MURARSKI

Masonry pencil / Maurerstift / Карандаш каменщика / Олівець мулярський / Ácsceruza / Creion piatră / Zednická tužka / Ceruzka murárska / Zidarski svinčnik / Mürininko pieštukas / Zimulis mürnieka / Mürreparliats / Molus / Olovka za majstore / Olovka za majstore / Μολύβι λιθοδόμου / Lápiz de albañil / Matita da muratore / Lápiz p. Alvenaria / Crayon de maçons / Metselaarspotlood



Ref.	L [mm]	☒	EAN
14A801	240	144/1008	5902062121714

OŁÓWEK DO SZKŁA

Pencil for glass / Glasstift / Карандаш по стеклу / Олівець по склу / Ácsceruza / Creion sticlă / Tužka na sklo / Ceruzka sklenárska / Svinčnik za steklo / Pieštukas stiklui / Zimulis stiklam / Klaasipliats / Molus za steklo / Olovka za staklo / Olovka za staklo / Μολύβι ξυλουργού / Lápiz para vidro / Matita per vetro / Lápiz para vidro / Crayon à verre / Glaspotlood



Ref.	L [mm]	☒	EAN
14A802	240	144/1008	5902062121721

SZPADEL

Spade / Spaten / Застын / Лопата штыковая / Ásó nyelezve / Lopätjica / Rýč / Rýl' lichobežníkový / Lopata / Kastuvas / Lāpsta / Labidas / Лопата права / Lopata / Lopata / Φτυάρι / Pala / Pala / Pá / Louchet / Spade



Ref.		EAN
15A035	1/1	5902062150073

SZPADEL

Spade / Spaten / Застын / Лопата штыковая / Ásó nyelezve / Lopätjica / Rýč / Rýl' lichobežníkový / Lopata / Kastuvas / Lāpsta / Labidas / Лопата права / Lopata / Lopata / Φτυάρι / Pala / Pala / Pá / Louchet / Spade



Ref.		EAN
15A040	1/1	5902062150110

SZPADEL

Spade / Spaten / Застын / Лопата штыковая / Ásó nyelezve / Lopätjica / Rýč / Rýl' lichobežníkový / Lopata / Kastuvas / Lāpsta / Labidas / Лопата права / Lopata / Lopata / Φτυάρι / Pala / Pala / Pá / Louchet / Spade



Ref.		EAN
15A045	1/1	5902062150127

ŁOPATA

Shovel / Schaufel / Лопата / Лопата совковая / Lapát nyelezve / Lopatä / Lopata / Lopata ocel'ová / Lopata / Kastuvas / Lāpsta / Kühvel / Лопата крива / Lopata / Lopata / Φτυάρι / Pala / Badile / Pá / Pelle / Schep



Ref.		EAN
15A050	1/1	5902062150134

SZPADEL

Spade / Spaten / Застын / Лопата штыковая / Ásó nyelezve / Lopätjica / Rýč / Rýl' lichobežníkový / Lopata / Kastuvas / Lāpsta / Labidas / Лопата права / Lopata / Lopata / Φτυάρι / Pala / Pala / Pá / Louchet / Spade



Ref.		EAN
15A055	1/1	5902062150141

ŁOPATA WĘGLOWA

Shovel / Schaufel / Лопата / Лопата совковая / Lapát nyelezve / Lopatä / Lopata / Lopata ocel'ová / Lopata / Kastuvas / Lāpsta / Kühvel / Лопата крива / Lopata / Lopata / Φτυάρι / Pala / Badile / Pá / Pelle / Schep



Ref.		EAN
15A060	1/1	5902062150158

SZPADEL

Spade / Spaten / Застын / Лопата штыковая / Ásó nyelezve / Lopätjica / Rýč / Rýl' lichobežníkový / Lopata / Kastuvas / Lāpsta / Labidas / Лопата права / Lopata / Lopata / Φτυάρι / Pala / Pala / Pá / Louchet / Spade



Ref.		EAN
15A020	1/1	5902062150011

SZPADEL

Spade / Spaten / Застын / Лопата штыковая / Ásó nyelezve / Lopätjica / Rýč / Rýl' lichobežníkový / Lopata / Kastuvas / Lāpsta / Labidas / Лопата права / Lopata / Lopata / Φτυάρι / Pala / Pala / Pá / Louchet / Spade



Ref.		EAN
15A025	1/1	5902062150035

ŁOPATA

Shovel / Schaufel / Лопата / Лопата совковая / Lapát nyelezve / Lopatä / Lopata / Lopata ocel'ová / Lopata / Kastuvas / Lāpsta / Kühvel / Лопата крива / Lopata / Lopata / Φτυάρι / Pala / Badile / Pá / Pelle / Schep



Ref.		EAN
15A030	1/1	5902062150059

NOŹYCE DO PRĘTÓW

Mini bolt cutter / Stabschere / Ножницы для проволоки / Ножницы для дроту / Drótavágófó / Scule tăiere minișeruburi / Blokové nůžky / Strihač svotníkov / Škarje za žico / Mini žirkles armatūrai / Skrūvjokdis mini / Poldilöikur (váike) / Ножница за арматура / Škare za armaturu / Makaze za armaturu / Μίνι μπουλονκόφτης / Cortavarillas / Cesoia per barre / Tesoura p. Vergas / Cisaille à fers plats / Scharen voor stangen

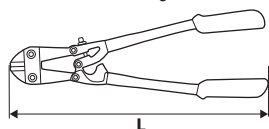

CrV

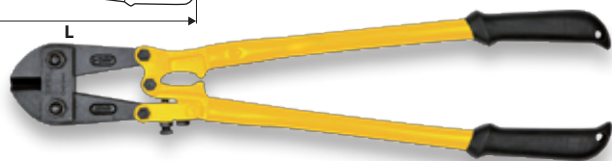

Ref.	L [mm]	Ø max. [mm]	☒	EAN
01A118	450	8	0/12	5902062011343
01A124	600	10	0/12	5902062011350
01A130	750	12	0/6	5902062011398
01A135	900	16	0/4	5902062011558

NOŹYCE DO PRĘTÓW

Mini bolt cutter / Stabschere / Ножницы для проволоки / Ножницы для дроту / Drótavágófó / Scule tăiere minișeruburi / Blokové nůžky / Strihač svotníkov / Škarje za žico / Mini žirkles armatūrai / Skrūvjokdis mini / Poldilöikur (váike) / Ножница за арматура / Škare za armaturu / Makaze za armaturu / Μίνι μπουλονκόφτης / Cortavarillas / Cesoia per barre / Tesoura p. Vergas / Cisaille à fers plats / Scharen voor stangen

NARZĘDZIA RĘCZNE / BUDOWLANE

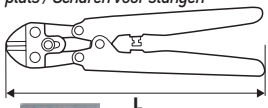

Ref.	L [mm]	Ø max. [mm]	☒	EAN
01A117	210	4	6/48	5902062011381

NOŹYCE

Scissors / Schere / Ножницы / Ножницы / Olló / Foarfece / Nůžky / Nožnice / Škarje / Žirkles / Grieznes / Käärid / Ножница / Škare / Makaze / Ψαλίδια / Tijeras para moqueta / Forbici / Tesoura / Cisaille / Scharen

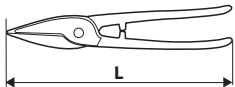

Ref.	L [mm]	info	☒	EAN
D102-250	250	prawe, berlińskie; right; правые	0/5	4010220000519

NOŹYCE

Scissors / Schere / Ножницы / Ножницы / Olló / Foarfece / Nůžky / Nožnice / Škarje / Žirkles / Grieznes / Käärid / Ножница / Škare / Makaze / Ψαλίδια / Tijeras para moqueta / Forbici / Tesoura / Cisaille / Scharen

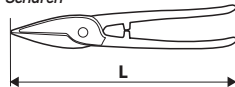

Ref.	L [mm]	info	☒	EAN
D107-250	250	prawe, wygięte; right; правые	0/5	4010220000779
D107-250L	250	lewe, wygięte; left; левые	0/5	4010220000786
D107-275	275	prawe, wygięte; right; правые	0/5	4010220000793
D107-275L	275	lewe, wygięte; left; левые	0/5	4010220000809

NOŹYCE

Scissors / Schere / Ножницы / Ножницы / Olló / Foarfece / Nůžky / Nožnice / Škarje / Žirkles / Grieznes / Käärid / Ножница / Škare / Makaze / Ψαλίδια / Tijeras para moqueta / Forbici / Tesoura / Cisaille / Scharen

Erđi

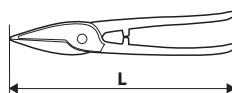

Ref.	L [mm]	info	☒	EAN
D116-260	260	prawe uniwersalne; right; правые	0/5	4010220001257
D116-260L	260	lewe uniwersalne; left; левые	0/5	4010220001264
D116-280	280	prawe uniwersalne; right; правые	0/5	4010220001271
D116-280L	280	lewe uniwersalne; left; левые	0/5	4010220001288

NOŹYCE

Scissors / Schere / Ножницы / Ножницы / Olló / Foarfece / Nůžky / Nožnice / Škarje / Žirkles / Grieznes / Käärid / Ножница / Škare / Makaze / Ψαλίδια / Tijeras para moqueta / Forbici / Tesoura / Cisaille / Scharen

Erđi

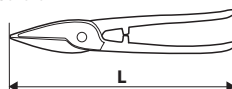

Ref.	L [mm]	info	☒	EAN
D118-300	300	prawe; right; правые	0/5	4010220001370
D118-300L	300	lewe; left; левые	0/5	4010220001387

NOŹYCE DO BLACHY

Tin snip / Blechscher / Ножницы по жесту / Ножницы по листовому металлу / Lemezolló / Foarfece tăiere tablă / Nůžky na plech / Nožnice na plech / Škarje za pločevino / Žirkles skardai / Grieznes skārdam / Plekikäärid / Ножница за ламарина / Škare za lim / Makaze za lim / Ψαλίδι λαμαρίνας / Tijeras corta chapa / Forbici da lattoniere / Tesoura para chapa / Cisaille coupe-tôle / Blikscharen

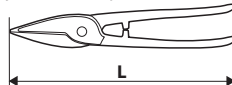

Ref.	L [mm]	☒	EAN
01A445	300	0/6	5902062180728

NOŹYCE DO BLACHY

Tin snip / Blechscher / Ножницы по жесту / Ножницы по листовому металлу / Lemezolló / Foarfece tăiere tablă / Nůžky na plech / Nožnice na plech / Škarje za pločevino / Žirkles skardai / Grieznes skārdam / Plekikäärid / Ножница за ламарина / Škare za lim / Makaze za lim / Ψαλίδι λαμαρίνας / Tijeras corta chapa / Forbici da lattoniere / Tesoura para chapa / Cisaille coupe-tôle / Blikscharen

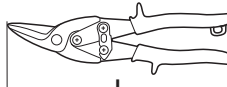

CrV

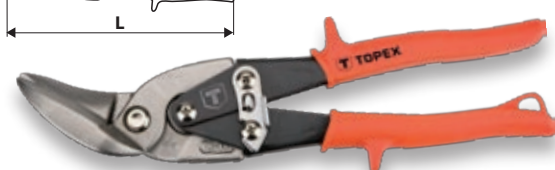

Ref.	L [mm]	info	☒	EAN
01A430	240	odgięte lewe; left; левые	0/48	5902062180407
01A431	240	odgięte prawe; right; правые	0/48	5902062180414

NOŽYCE DO BLACHY

Tin snip / Blechscherer / Ножницы по жесту / Ножницы по листовому металлу / Lemezolló / Foarfeca tăiere tablă / Nůžky na plech / Nožnice na plech / Škarje za pločevino / Žirklės skardai / Grieznes skārdam / Plekikāārid / Ножница за ламарина / Škare za lim / Makaze za lim / Ψαλίδι λαμαρίνας / Tijeras corta chapa / Forbici da lattoniere / Tesoura para chapa / Cisaille coupe-tôle / Blikscharen

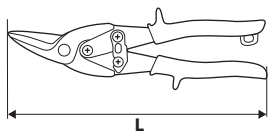

CrV



Ref.	L [mm]	info	☒	EAN
01A425	250	lewe; left; левые	0/48	5902062180353
01A426	250	prawe; right; правые	0/48	5902062180360
01A427	250	proste; stright; прямые	0/48	5902062180377

NOŽYCE SZTANCOWE

Tin snip / Stanzschere / Ножницы высечные / Ножницы по листовому металлу / Lemezolló / Foarfeca tăiere tablă / Vysekāāncā nůžky / Nožnice na plech na otvory / Škarje za pločevino / Žirklės skardai / Grieznes skārdam / Plekikāārid / Ножница за ламарина / Škare za lim / Makaze za lim / Ψαλίδι λαμαρίνας / Tijeras de acuiar / Forbici da lattoniere / Tesoura / Cisaille à découper des formes / Plaattknipscharen

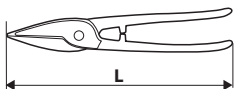

DIN 6438

Ref.	L [mm]	info	☒	EAN
01A441	260	do cięć kształtowych	0/36	5902062180711

NOŽYCE DO BLACHY

Tin snip / Blechscherer / Ножницы по жесту / Ножницы по листовому металлу / Lemezolló / Foarfeca tăiere tablă / Nůžky na plech / Nožnice na plech / Škarje za pločevino / Žirklės skardai / Grieznes skārdam / Plekikāārid / Ножница за ламарина / Škare za lim / Makaze za lim / Ψαλίδι λαμαρίνας / Tijeras corta chapa / Forbici da lattoniere / Tesoura para chapa / Cisaille coupe-tôle / Blikscharen

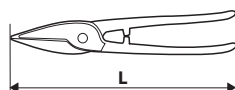

DIN 6438

Ref.	L [mm]	☒	EAN
01A440	250	0/36	5902062180513

GWINTOWNIKI

Taps / Gewindebohrer / Метчики / Мітчики / Menetvágók / Tarozí / Závıtnıky / Závıtnıky / Vreznıky nāvıjı / Srıegıtuvajı / Vıtırıurbıs / Keertıerıurııd / Метчіццц / Alati za rezanjı nāvıjı / Nareznı svrdla / Ξıλοφάγος діάνοıξıs σπειρωμάτων / Machos de roscar / Maschi / Machos / Tarauds / Draadsnıjtappen

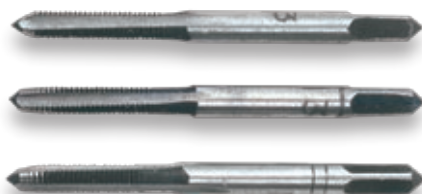

DIN 352 WOLFRAM

Ref.	Ø [nr]	☒	EAN
14A203	M3	10/200	5902062060662
14A204	M4	10/200	5902062060679
14A205	M5	10/200	5902062060686
14A206	M6	10/200	5902062060693
14A208	M8	10/200	5902062060709
14A210	M10	10/200	5902062060716
14A212	M12	10/200	5902062060723



ΠΟΚΡΕΤΟ DO GWINTOWNIKÓW

Handle for hand tap / Gewindebohrergrıff / Βοροτοκ для метчіцков / Βοροτοκ для позначніцка / Menetfırıo hajtıvas / Manıvelā burghıu manual / Vratıdlo k zāvıtnıkım / Vratıdlo na zāvıtnıky / Ročaj za vreznıke nāvıjı / Rankena sıriegıklıams / Vıtırıgıeža turētājs / Kāsıkraanı kāepıde / Върток за метчік / Držāč Ureznıca / Okretac ureznıka / Χειρολαβή για κολλοζόζ / Manıvela para machos de roscar / Manopola per maschi / Chave para machos / Tourne-ā-gauche / Draaiknop voor draadtap



Ref.	L [mm]	☒	EAN
14A410	215	0/20	5902062060792

NARZYŃKA

Die / Schneideisen / Πλασκα / Πλασκα / Menetıetszı / Fılierā / Zāvıtovā čelist / Zāvıtovē očka / Nareznıky nāvıjı / Srıegıpvıvė / Vıtırıgıezıs / Valıvıorm / Πλασκα / Nareznıca / Nareznıca / Εlıκοκόπηττα / Cojınete de roscar / Madrevıte / Cassonete / Fıliere / Snıjplaat



DIN 233 WOLFRAM

Ref.	Ø [nr]	☒	EAN
14A303	M3 [25x9mm]	10/200	5902062060808
14A304	M4 [25x9mm]	10/200	5902062060815
14A305	M5 [25x9mm]	10/200	5902062060822
14A306	M6 [25x9mm]	10/200	5902062060839
14A308	M8 [25x9mm]	10/200	5902062060846
14A310	M10 [25x9mm]	10/200	5902062060853
14A312	M12 [25x9mm]	10/200	5902062060860



OPRAWKA DO NARZYNEK

Handle for die / Schneideisenfassung / Βοροτοκ для плашек / Βοροτοκ для плаσκα / Menetıetszı hajtıvas / Mıner fılierā / Objımkı zāvıtnıc / Vratıdlo na očka / Ročaj za nareznıke nāvıjı / Srıegıpvıvė rėmas / Vıtırıgıeža turētājs / Valıvıormı kāepıde / Върток за плаσка / Držāč nareznıca / Okretac nareznıka / Χειρολαβή για εlıκοκόπηττα / Terraıa de cojınetes / Portafıliera / Armadura p. Cassonetes / Monture de fıliere / Kader voor snıjplaten



Ref.	L [mm]	☒	EAN
14A420	230	0/10	5902062060587

TOPEX

NARZYNIKI I GWINTOWNIKI

Tap and die set / Schneideisen und Gewindebohrer / Плашки и метчики / Позначники и плашки, набір / Menetkészítő készlet / Set scule tăiere filet interior și exterior / Závítnice a závitníky / Súprava závitníkov / Gamitura vreznikov in nareznikov navoja / Snięgpjovės ir sriegikliai / Vītņgriežu komplekts / Kraani ja valuvormi komplekt / Метчицу и плашки / Nareznice i ureznice set / Set ureznika i nareznika / Ελικοκάφτες και κολαούζα / Cojinetes y machos de rosca, juego / Madreviti e maschi / Cassonetes e roscas / Filières et tarauds / Snijplaat en schroefdraad snijtoestel



x20

DIN 352

DIN 223

WOLFRAM

Ref.	Ø [nr]	⊠	EAN
14A425	M3-M12	0/12	5902062544186

NARZYNIKI I GWINTOWNIKI

Tap and die set / Schneideisen und Gewindebohrer / Плашки и метчики / Позначники и плашки, набір / Menetkészítő készlet / Set scule tăiere filet interior și exterior / Závítnice a závitníky / Súprava závitníkov / Gamitura vreznikov in nareznikov navoja / Snięgpjovės ir sriegikliai / Vītņgriežu komplekts / Kraani ja valuvormi komplekt / Метчицу и плашки / Nareznice i ureznice set / Set ureznika i nareznika / Ελικοκάφτες και κολαούζα / Cojinetes y machos de rosca, juego / Madreviti e maschi / Cassonetes e roscas / Filières et tarauds / Snijplaat en schroefdraad snijtoestel



x32

DIN 352

DIN 223

WOLFRAM

Ref.	Ø [nr]	⊠	EAN
14A426	M3-M12	0/12	5902062062024

GWINTOWNIKI

Taps / Gewindebohrer / Метчики / Митчики / Menetvágók / Tarazi / Závítníky / Závítníky / Vrezniki navoja / Snięgpjovės ir sriegikliai / Keertperuuriid / Метчицу / Alati za rezanje navoja / Narezna svrdla / Ελοφάρος διάνοιξης σπειρωμάτων / Machos de rosca / Maschi / Tarauds / Draadsnijtappen



x21

DIN 352

WOLFRAM

Ref.	Ø [nr]	⊠	EAN
14A430	M3-M12	0/12	5902062062031

IMADŁO

Vice / Schraubstock / Туска / Леццана / Satu / Menghinä / Svěrák / Zverák liatinový pevný / Primež / Spaustuvos / Kalts / Kruustangid / Менземе / Radionička stega / Mengele / Μέγεγνη / Tornillo de banco de precisión / Morsa / Tomo / Etou / Breekijzer

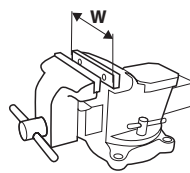

Ref.	W [mm]	⊠	EAN
07A107	75	0/1	5902062043757
07A110	100	0/1	5902062040015
07A112	125	0/1	5902062040022
07A115	150	0/1	5902062040039

IMADŁO

Vice / Schraubstock / Туска / Леццана / Satu / Menghinä / Svěrák / Zverák liatinový pevný / Primež / Spaustuvos / Kalts / Kruustangid / Менземе / Radionička stega / Mengele / Μέγεγνη / Tornillo de banco de precisión / Morsa / Tomo / Etou / Breekijzer

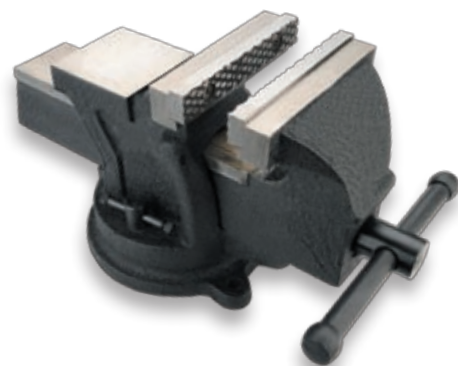
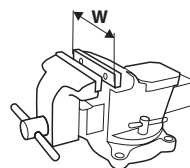

Ref.	W [mm]	⊠	EAN
07A210	100	0/1	5902062040046
07A212	125	0/1	5902062040053
07A215	150	0/1	5902062040060

IMADŁO

Vice / Schraubstock / Туска / Леццана / Satu / Menghinä / Svěrák / Zverák liatinový pevný / Primež / Spaustuvos / Kalts / Kruustangid / Менземе / Radionička stega / Mengele / Μέγεγνη / Tornillo de banco de precisión / Morsa / Tomo / Etou / Breekijzer



AL

Ref.	W [mm]	Ra [mm]	info	⊠	EAN
07A306	60	65		0/20	5902062043061
07A310	100	95	możliwość mocowania do stołu	0/20	5902062043078

IMADŁO

Vice / Schraubstock / Тиски / Лещата / Satu / Menghinä / Svěrák / Zverák liatinový pevný / Primež / Spaustuvas / Kalts / Kruustangid / Менгеме / Radionička stěga / Mengele / Μέγερνη / Tornillo de banco de precisión / Morsa / Tomo / Etau / Breekijzer



AL

Ref.	W [mm]	☒	EAN
07A307	75	0/20	5902062043863

SZCZOTKA DRUCIANA

Wire brush / Drahtbürste / Щетка проволочная / Щітка по металу / Spidkefe / Perie metal / Drátěný kartáč / Keřa drôténá univerzálná / Žična krtača / Vielinis šepetys / Dräšu birste / Traathari / Четка телена / Četka sa PVC drškom / Četka / Συρμάτινη βούρτσα / Cepillo de alambre / Spazzola metallica / Escova de arame / Brosse métallique / Draadborstel



Ref.	L [mm]	☒	EAN
14A523	240	12/120	5902062120960

SZCZOTKA DRUCIANA

Wire brush / Drahtbürste / Щетка проволочная / Щітка по металу / Spidkefe / Perie metal / Drátěný kartáč / Keřa drôténá univerzálná / Žična krtača / Vielinis šepetys / Dräšu birste / Traathari / Четка телена / Četka sa PVC drškom / Četka / Συρμάτινη βούρτσα / Cepillo de alambre / Spazzola metallica / Escova de arame / Brosse métallique / Draadborstel



Ref.	rząd	☒	EAN
14A614	4	12/120	5902062121677
14A615	5	12/120	5902062121684
14A616	6	12/120	5902062121691

PILNIK DO METALU

Steel file / Metallfeile / Напильник по металлу / Пильник по металу / Reszeló fémhez / Tãietoare metal / Pilnik na kov / Pilnik plochý / Konica za kovino / Dildé metalui / Vile metálam / Terasviil / Плуа / Турпија за метал / Турпије за метал / Λίμα για μέταλλο / Lima para metal / Lima per metallo / Lima para metal / Lime à métal / Metaalvijl

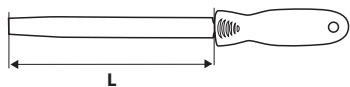

T12



Ref.	L [mm]	info	☒	EAN
06A721	200/2	—	10/100	5902062101662
06A722	200/2	—	10/100	5902062101679
06A723	200/2	●	10/100	5902062101686
06A724	200/2	■	10/100	5902062101693
06A725	200/2	▲	10/100	5902062101709

PILNIKI DO METALU

Steel file set / Metallfeilen / Напильники по металлу / Пильник по металу, набір / Reszelókészlet / Set tãietoare metal / Pilnik na kov / Súprava pilníkov / Konice za kovino / Dildés metalui / Vile metálam / Terasviilide komplekt / Плуа компл. / Турпија за метал set / Турпије за метал / Συλλογή λιμών για μέταλλο / Limas para metal / Lima per metallo / Lima para metal / Lime à métal / Metaalvijlen

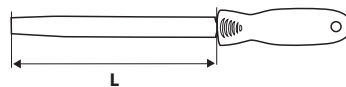

T12

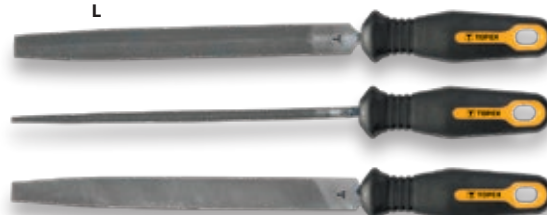

Ref.	L [mm]	N	info	☒	EAN
06A130	200/2	x3	—	0/40	5902062102638
06A230	200/2	x3	—	10/40	5902062101099
06A250	200/2	x5	—	10/40	5902062101105

PILNIK DO DREWNA

Wood rasp / Holzfeile / Рапикуль по дереву / Рапикуль / Faráspoly / Ráspel lemn / Pilnik na drevo / Rašpla plochá / Konica za les / Dildés medžiui / Vile kokam / Puiduraspel / Плуа / Турпија за дрво / Турпије за дрво / Ξύλινη ράσα / Lima para madera / Lama per legno / Lima para madeira / Rãpe à bois / Houtvijl

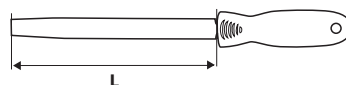

T12



Ref.	L [mm]	info	☒	EAN
06A831	200	—	10/100	5902062101716
06A832	200	●	10/100	5902062101723
06A833	200	●	10/100	5902062101730

PILNIKI DO DREWNA

Wood rasp set / Holzfeilen / Рапикуль по дереву / Рапикуль, набір / Ráspolykészlet / Set ráspel lemn / Pilnik na drevo / Súprava rašpli / Konice za les / Dildés medžiui / Viles kokam komplekts / Puidurasplite komplekt / Плуа компл. / Турпија за дрво / Турпије за дрво / Ξετ ξύλινης ράσας / Limas para madeira / Lima per legno / Limas para madeiras / Rãpes à bois / Houtvijlen

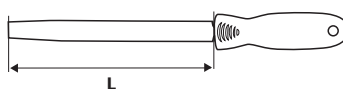

x31



Ref.	L [mm]	☒	EAN
06A330	200	10/60	5902062101112

PILNIK DO METALU

Steel file / Metallfeile / Напильник по металлу / Пильник по металу / Reszeló fémhez / Tãietoare metal / Pilnik na kov / Pilnik plochý / Konica za kovino / Dildé metalui / Vile metálam / Terasviil / Плуа / Турпија за метал / Турпије за метал / Λίμα για μέταλλο / Lima para metal / Lima per metallo / Lima para metal / Lime à métal / Metaalvijl

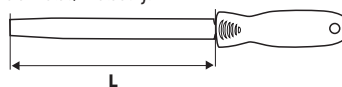

GCr15



Ref.	L [mm]	Ø [mm]	☒	EAN
06A786	200	4,0	0/12	5902062103284
06A788	200	4,8	0/12	5902062103291

PILNIKI IGLAKI

Needle files / Igel-Pfeilen / Нащфули / Напилки голчисти / Túreszelők / Mini-pile / Pilníky jehlové / Pilníky ihlové / Iglaste pile / Dildés, ylos / Adatvīles / Nöelviilid / Иглему нулу / Iglčaste turpije / Iglu turpije / Λίμες μοντελισμού / Limas de aguja / Lime tonde / Limas / Limes aiguilles / Naaldvijlen

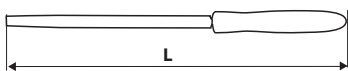

x6

Ref.	L [mm]	Ø [mm]	☒	EAN
06A010	150	3	5/100	5902062610201

PILNIKI IGLAKI

Needle files / Igel-Pfeilen / Нащфули / Напилки голчисти / Túreszelők / Mini-pile / Pilníky jehlové / Pilníky ihlové / Iglaste pile / Dildés, ylos / Adatvīles / Nöelviilid / Иглему нулу / Iglčaste turpije / Iglu turpije / Λίμες μοντελισμού / Limas de aguja / Lime adago / Limas / Limes aiguilles / Naaldvijlen

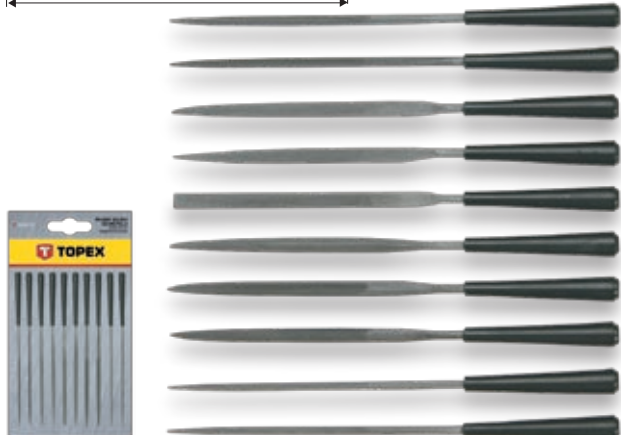
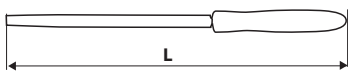

x10

Ref.	L [mm]	Ø [mm]	info	☒	EAN
06A020	140	3	-	25/100	5902062610102
06A015	140	3	z uchwytem	25/100	5902062610157

PILNIKI IGLAKI

Needle files / Igel-Pfeilen / Нащфули / Напилки голчисти / Túreszelők / Mini-pile / Pilníky jehlové / Pilníky ihlové / Iglaste pile / Dildés, ylos / Adatvīles / Nöelviilid / Иглему нулу / Iglčaste turpije / Iglu turpije / Λίμες μοντελισμού / Limas de aguja / Lime adago / Limas / Limes aiguilles / Naaldvijlen

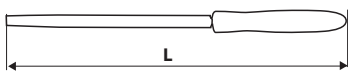

x5

Ref.	L [mm]	Ø [mm]	☒	EAN
06A000	140	4,0	0/160	5902062103222

TRZONEK DO PILNIKA

File handle / Handgriff für Pfeile / Рукотна для напильника / Хвостовик до напилька / Reszelőnyél / Måner de pilă / Násada pilníku / Stopka pilníka / Ročaj za pilo / Rankenélé dillei / Vīles spals / Viilikäepide / Дръжка на пилата / Ručka za turpiju / Držač za turpije / Χερσούλι ράσας / Mango para lima / Manico / Cabo p. Lima / Manche de lime / Handvat voor vijl



Ref.	L [mm]	☒	EAN
06A615	115	0/1	5902062948830
06A635	135	0/1	5902062948847

PRZECINAK

Chisel / Meißel / Зубило / Зубило / Véső / Daltă / Sekáč / Sekáč / Dleto / Kirstukas / Kalts / Peitel / Сечак / Sječač / Sekac / Καλέμι / Cortafrió / Tagliolo / Cortador / Burin / Beitel



CrV

Ref.	L [mm]	☒	EAN
03A320	200	6/72	5902062272003
03A325	250	6/36	5902062272508

PUNKTAK

Central punch / Körner / Кернер / Пунктур / Pontozó / Ciocan de găurit / Dűlkováč / Jamkár / Тоčkalo / Žymeklis / Punktisits / Torn / Център / Тоčkalo / Tackas / Πόντα / Punzón centrador / Punzone / Punção / Pointeau / Doorslag



Ref.	L [mm]	Ø [mm]	☒	EAN
03A441	100,0	6,3	0/100	5902062260147
03A442	127,5	9,4	0/100	5902062260383
03A445	152,0	12,7	0/100	5902062260123

PRZECINAK

Chisel / Meißel / Зубило / Зубило / Véső / Daltă / Sekáč / Sekáč / Dleto / Kirstukas / Kalts / Peitel / Сечак / Sječač / Sekac / Καλέμι / Cortafrió / Tagliolo / Cortador / Burin / Beitel

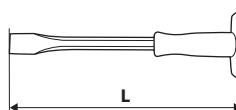

CrV

Ref.	L [mm]	Ø [mm]	☒	EAN
03A170	300	16	0/24	5902062032072
03A171	300	18	0/24	5902062032089

PRZEBIJAK

Punch / Lochhammer / Зубило / Пробувач / Hegyes véső / Preducea / Průbojník / Pribojnik / Prebijač / Skylmušys / Caurumsītis / Auguraud / Шило / Probijač / Probojac / Σμίλη / Puntero / Punzone / Saca-bocado / Perçoir / Puntslag

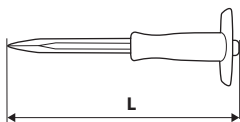

CrV

Ref.	L [mm]	Ø [mm]	☒	EAN
03A180	300	19	0/24	5902062032096

PRZECINAK

Chisel / Meißel / Зубило / Чубило / Véső / Daltă / Sekáč / Sekáč / Dleto / Kirstukas / Kalts / Peitel / Сечак / Sjekáč / Sekac / Καλέμι / Cortafrío / Tagliolo / Cortador / Burin / Beitel

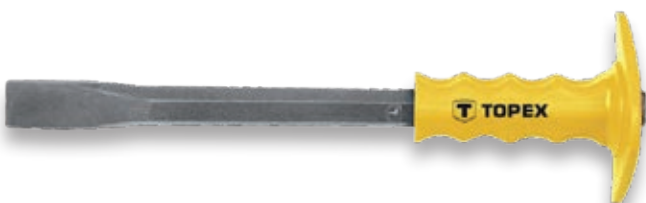
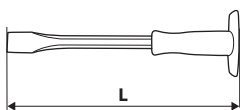

Ref.	L [mm]	Ø [mm]	☒	EAN
03A136	300	16	0/24	5902062031075
03A139	300	19	0/30	5902062031525
03A149	400	19	0/24	5902062031532
03A159	500	19	0/24	5902062031556

PRZEBIJAK

Punch / Lochhammer / Зубило / Пробувач / Hegyes véső / Preducea / Průbojník / Pribojnik / Prebijač / Skylmušys / Caurumsītis / Auguraud / Шило / Probijač / Probojac / Σμίλη / Puntero / Punzone / Saca-bocado / Perçoir / Puntslag

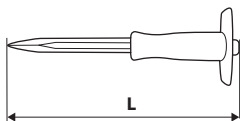

Ref.	L [mm]	Ø [mm]	☒	EAN
03A169	400	19	0/40	5902062031563

ŁOM

Wrecking bar / Brecheisen / Лом / Лом / Ládabontó / Rangă montare / Pácidlo / Pácidlo / Žebljarska babica / Laužtuvas / Lauznis / Kang / Козу крак / Poluga za čavle / Pajser / Λοστός / Palanca / Leva / Pê-de-cabra / Pied-de-biche / Breekijzer

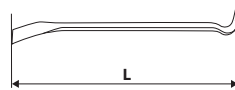

Ref.	L [mm]	Ø [mm]	☒	EAN
04A130	300	21x10	0/20	5902062041302
04A140	400	21x11	0/20	5902062031068
04A160	600	29x16	0/10	5902062031129
04A175	750	30x16	0/10	5902062045041
04A190	900	30x16	0/10	5902062045058

ŁOM

Wrecking bar / Brecheisen / Лом / Лом / Ládabontó / Rangă montare / Pácidlo / Pácidlo / Žebljarska babica / Laužtuvas / Lauznis / Kang / Козу крак / Poluga za čavle / Pajser / Λοστός / Palanca / Leva / Pê-de-cabra / Pied-de-biche / Breekijzer

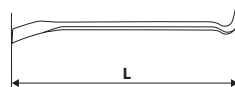

Ref.	L [mm]	Ø [mm]	☒	EAN
04A240	400	16	0/12	5902062045065
04A250	500	16	0/12	5902062045072
04A260	600	16	0/12	5902062030429
04A280	800	19	0/10	5902062031389
04A210	1000	18	0/10	5902062045089
04A212	1200	18	0/10	5902062045096

ŁOM

Wrecking bar / Brecheisen / Лом / Лом / Ládabontó / Rangă montare / Pácidlo / Pácidlo / Žebljarska babica / Laužtuvas / Lauznis / Kang / Козу крак / Poluga za čavle / Pajser / Λοστός / Palanca / Leva / Pê-de-cabra / Pied-de-biche / Breekijzer



Ref.	L [mm]	Ø [mm]	info	☒	EAN
04A312	1200	25	żebrowany	0/1	5902062031280
04A315	1500	25	żebrowany	0/1	5902062031297

WYKRĘTAKI DO ŚRUB

Screw extractor set / Schraubendreher / Экстракторы для винтов / Викручувачі зламаних гвинтів / Törtsavar-kihajtó készlet / Set înlăturare suruburi / Vytahováč šroubů / Súrpana vytahovačov zalomených skrutiek / Garnitura odvijacev vijakov / Atsuktuvai varžtams / Skrūvju izvilcējs / Kruiemalduskomplekt / Экстрактор номпл / Izvijac polomljenih vijaka set / Izvijac polomljenih vijaka / Συλλογή μηχανημάτων αφαίρεσης βιδών / Extractores de tornillos / Svitabulloni / Saca-parafusos / Devisesuses pour vis / Schroevenlosdraaiers



x5

Ref.	Ø [mm]	☒	EAN
14A110	3,3 - 19,0	10/100	5902062062048

TOPEX

ДОВІЯКИ ДО ГВОЗДІ

Nail punch set / Nageltreiber / Довійники для гвоздів / Пробивач для цвяхів, набір / Stiftkiütő készlet / Set ciocane de găurit / Zatloukač hřebíků / Súprava priebojníkov / Žebřalník / Viniakalis / Punktstift naglām / Naelalõõmiskomplekt / Замбу / Probijači set / Probijas set / Ζουμπιάς για καρφιά / Punzones para clavos / Battola per chiodi / Ρυγχόο para cravar / Chasse-clous / Spijkerpons

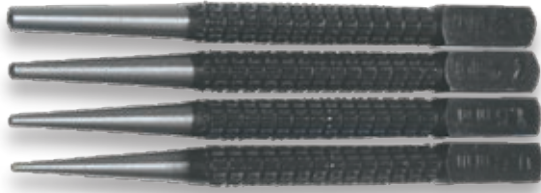

x4

Ref.	Ø [mm]	☒	EAN
03A440	0,8 - 3,2	6/60	5902062031396

ВЫСІАКИ ДО ОТВОРІВ

Hole punch set / Lochausschneidemaschine / Пробойники круглых отверстий / Кернер, набір / Bőrlukasztó készlet / Set perforare găuri / Выкрајовачка до отворі / Súprava vysekávaných / Gamitura prebijačev / Pjovikliai ertmėms / Saurositėju komplekts / Augustaja komplekt / Замбу компл. / Probijači set / Zumbeset / Συρόμπιες / Sacabocados / Tagliatori / Matriz de recortar / Bedanes à ouvertures / Gatenknippers



x9

Ref.	Ø [mm]	☒	EAN
03A490	3 - 12	0/10	5902062031761

ДЪЛТО

Wood chisel / Beitel / Стамеска / Стамеска / Favésõ / Daltã lemn / Dlátõ / Dlátõ ploché / Dleto / Kaltas / Kalts / Peitel / Длето / Dlijeto / Dleto / Σμίλη με ξύλινη λαβή / Formón / Scalpello / Raspador / Ciseau / Beitel

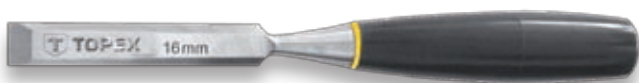

Ref.	W [mm]	☒	EAN
09A106	6	6/120	5902062101129
09A108	8	6/120	5902062101136
09A110	10	6/120	5902062101143
09A112	12	6/120	5902062101150
09A114	14	6/120	5902062101167
09A115	15	6/120	5902062101174
09A116	16	6/120	5902062101181
09A118	18	6/120	5902062101198
09A120	20	6/120	5902062101204
09A122	22	6/120	5902062101211
09A125	25	6/120	5902062101228
09A132	32	6/72	5902062101235
09A138	38	6/48	5902062101242

ДЪЛТА

Chisels / Beitel / Стамески / Зубуна / Favésõk / Dalta / Dlátõ / Dlátõ / Dleta / Kaltai / Kalti / Peitlid / Длетта / Dlijeta / Dleta / Κοιλιόια / Formones / Set di scalpelli / Conjunto de Raspadores / Jeu de ciseaux / Beitels

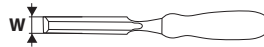

x4

Ref.	W [mm]	☒	EAN
09A310	6, 12, 18, 24	5/30	5902062102874

ДЪЛТО

Wood chisel / Beitel / Стамеска / Стамеска / Favésõ / Daltã lemn / Dlátõ / Dlátõ ploché / Dleto / Kaltas / Kalts / Peitel / Длето / Dlijeto / Dleto / Σμίλη με ξύλινη λαβή / Formón / Scalpello / Raspador / Ciseau / Beitel

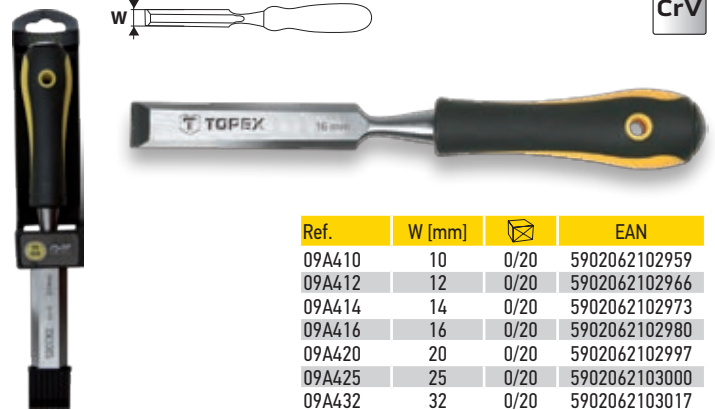
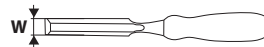

CrV

Ref.	W [mm]	☒	EAN
09A410	10	0/20	5902062102959
09A412	12	0/20	5902062102966
09A414	14	0/20	5902062102973
09A416	16	0/20	5902062102980
09A420	20	0/20	5902062102997
09A425	25	0/20	5902062103000
09A432	32	0/20	5902062103017

ЅЦИСК СТОЛАРСКИ

F-clamp / Schraubzwinge / Струбцина столарна / Струбцина столарна / Gyorscsavarszorító / Clemã în forma F / Truhlářská svorka / Zvierka stolárska / Mizarska spona / Spaustuvos staliui / Spiles galdnieka / F-klamber / Стяга / Stolarska stega / Stolarska stega / Σφιγκτήρας ξυλουργού / Sargento / Morsa di falegname / Grampo de marcenaria / Serre-joint de menuisier / Timmermansklemmen

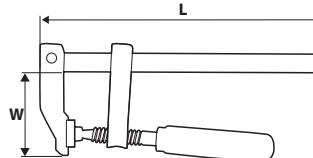

Ref.	L [mm]	W [mm]	☒	EAN
12A100	150	50	0/25	5902062102928
12A102	250	50	0/25	5902062102935
12A120	300	80	0/25	5902062102799
12A123	300	120	0/20	5902062102805
12A125	500	120	0/10	5902062102812
12A128	800	120	0/10	5902062102829
12A130	1000	120	0/10	5902062102836
12A135	1500	120	0/10	5902062102904

ŚCISK AUTOMATYCZNY

Quick clamp / Automatizwinge / Струбцина автоматическая / Струбцина столярна / Kézi szorító / Clemă cu acțiune rapidă / Automatická svorka / Zvierka automatická / Avtomatska spona / Spaustuvas / Spiles automātiskās / Kiirklamber / Стяга / Stolarska stega / Stolarska stega / Σφιγκτήρας ελατηρίων / Sargento automático / Morsa automatica / Grampo automático / Serre-joint automatique / Automatische klemmen

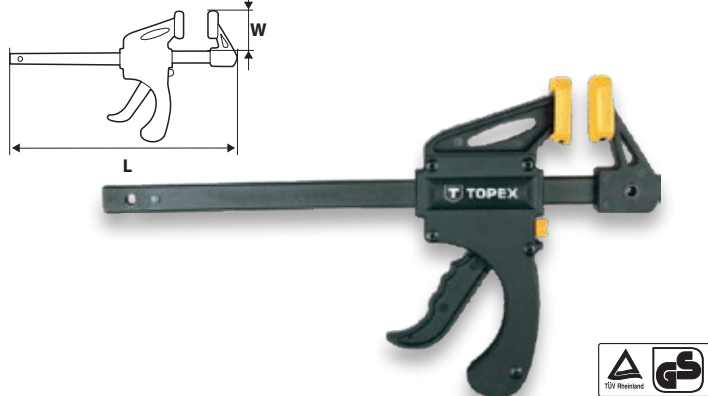

Ref.	L [mm]	W [mm]	☒	EAN
12A515	150	60	0/6	5902062125156
12A520	200	60	0/6	5902062125200
12A530	300	60	0/6	5902062125309
12A545	450	60	0/6	5902062125453
12A560	600	60	0/6	5902062125606
12A575	750	60	0/6	5902062125750
12A590	900	60	0/6	5902062125903

ŚCISK NYLONOWY

Nylon quick clamp / Nylon-Schraubzwinde / Струбцина нейлоновая / Струбцина нейлоновая / Műanyag szorító / Menghină de nylon / Svorka nylonová / Zvierka nylonová / Najlonska spona / Plastmasiniai spaustai / Neilona spiles / Nailonpitskruvi / Найлоново менземе / Najlonska stezaljka / Najlonski stezači / Σφιγκτήρας πλαστικός / Prensa en "C" de nilón / Morsa di nylon / Grampo de nylon / Serre-joint nylon / Nylon klemmen



Ref.	L [mm]	☒	EAN
12A380	50	0/10	5902062123800
12A382	75	0/10	5902062123824
12A384	100	0/10	5902062123848

ŚCISK TAŚMOWY

Belt clamp / Bandzwinde / Струбцина ленточная / Струбцина стрічкова / Sarokszorító / Sistem rulant cleme / Pásová svorka / Zvierka rámková / Jermenska spona / Spaustuvas juostinis / Spiles lentveida / Rihmaklamber / Стяга лентова / Stega rojas / Stega rojas / Σφιγκτήρας λωρίδας / Prensa de cinta / Morsa a nastro / Grampo de fita / Serre-joint à bande / Bandklemmen

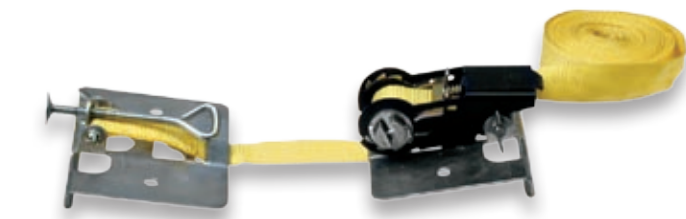

Ref.	L [mm]	W [mm]	D [mm]	☒	EAN
12A350	5000	25	1	10/20	5902062102898

ŚCISK NAROŻNIKOWY

Agle clamp / Winkelzwinde / Струбцина угловая / Струбцина нарижна / Sarokszorító / Clemă unghiulară / Rohová spojka / Zvierka rohová / Kotna spona / Gnybtai kampiniai / Spiles stūra / Nurgaklamber / Стяга ъглова / Kutna stega / Ugaona stega / Γωνιακός σφιγκτήρας / Tornillo de banco de esquina / Morsa angolare / Grampo de canto / Serre-joint angulaire / Hoekklemmen

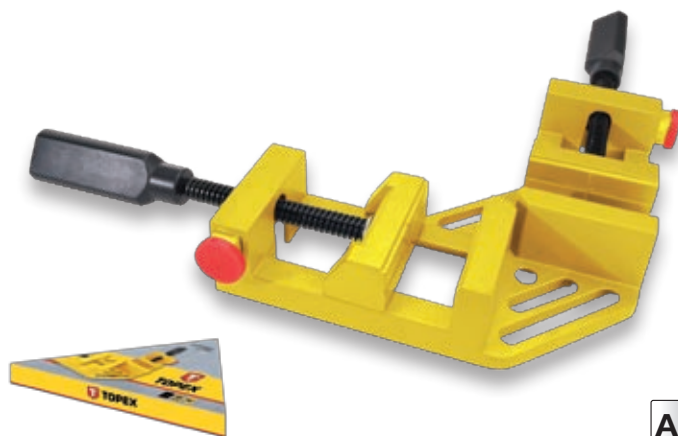

Ref.	L [mm]	W [mm]	☒	EAN
12A300	65	70	0/5	5902062705259

ŚCISK TAŚMOWY

Belt clamp / Bandzwinde / Струбцина ленточная / Струбцина стрічкова / Sarokszorító / Sistem rulant cleme / Pásová svorka / Zvierka rámková / Jermenska spona / Spaustuvas juostinis / Spiles lentveida / Rihmaklamber / Стяга лентова / Stega rojas / Stega rojas / Σφιγκτήρας λωρίδας / Prensa de cinta / Morsa a nastro / Grampo de fita / Serre-joint à bande / Bandklemmen



Ref.	L [mm]	W [mm]	D [mm]	☒	EAN
12A340	4000	25	1	0/20	5902062102300

ZDZIERAK

Scraper / Vorfeile / Рубанок / Шерхбель / Ráspoly / Cutit de raziuit / Rašplový hablík / Rašpl'a / Strgalo / Dilde / Èvele / Raspel / Нож за зруба оброботна / Odbojnik / Rende / Πλάνη / Escofina / Pialla per sgrossare / Lima grossa / Râpe / Krabber



Ref.	L [mm]	☒	EAN
11A406	140	10/100	5902062031914

ZDZIERAK

Scraper / Vorfeile / Рубанок / Шерхебель / Ráspoly / Čuťit de raziutt / Rašplový hoblík / Rašp'la / Strgalo / Dildé / Ěvele / Raspel / Нож за груба обработка / Odbojnik / Rende / Πλάνη / Escofina / Pialla per sgrassare / Lima grossa / Råpe / Krabber



Ref.	L [mm]	☒	EAN
11A411	250	6/60	5902062031938

OSTRZE DO ZDZIERAKA

Scraper blade / Schrupphobelklinge / Лезвие для рубанка-рашпиля / Лезо до шерхебеля / Penge / Lamä ractelä / Ostří do uběráku / Plátok náhradný / Rezilo za strgalo / Grandiklio geležte / Asmenis skārim / Kaabitsa leht / Ρενδε / Ulošci za strugač / Ulošci za stugac / Λεπίδα για ξύστρα / Hoja para escofina / Lama per pialla per sgrassare / Lâmina p. lima grossa / Tranchant de râpe / Krabberblad

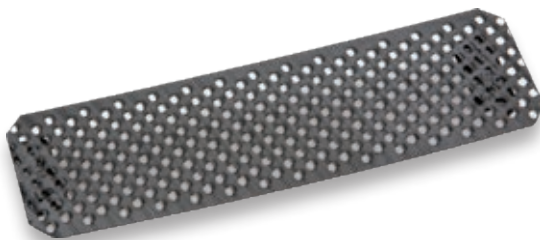

SK2

Ref.	L [mm]	uwagi	☒	EAN
11A409	140	do 11A406	20/200	5902062031921
11A413	250	do 11A411	20/200	5902062031945

STRUG

Plane / Hobel / Рубанок / Рубанок / Gyalu / Rindea / Hoblík / Hoblík / Oblič / Oblius / Ěvele / Häävel / Ρενδε / Blanja / Strug / Πλάνη / Cepillo / Pialla / Garlopa / Rabot / Schaafmachine



x2

Ref.	L [mm]	W [mm]	☒	EAN
11A115	150	50	0/36	5902062659507

STRUG

Plane / Hobel / Рубанок / Рубанок / Gyalu / Rindea / Hoblík / Hoblík / Oblič / Oblius / Ěvele / Häävel / Ρενδε / Blanja / Strug / Πλάνη / Cepillo / Pialla / Garlopa / Rabot / Schaafmachine



Ref.	L [mm]	W [mm]	W noža [mm]	☒	EAN
11A230	240	30	30	0/20	5902062100115

STRUG

Plane / Hobel / Рубанок / Рубанок / Gyalu / Rindea / Hoblík / Hoblík / Oblič / Oblius / Ěvele / Häävel / Ρενδε / Blanja / Strug / Πλάνη / Cepillo / Pialla / Garlopa / Rabot / Schaafmachine



Ref.	L [mm]	W [mm]	W noža [mm]	☒	EAN
11A314	200	55	40	0/1	5902062030894

NÓŽ DO SZKŁA

Bohle

Glass cutter / Glasmesser / Στεκροpez / Σκληροζ / Üvegvágó / Čuťit sticlä / Nůž na sklo / Rezač na sklo / Nož za steklo / Peilis stiklivi / Stiklgriezis / Kiasilōikur / Επμαζ Topex / Nožič za staklo / Nozic za staklo / Κοπικό εργαλείο γυαλιού / Cuchillo cortador de vidrio / Tagliavetro / Faca para vidro / Couteau à verre / Glasmes



Ref.	model	☒	EAN
320.0	Jobo	12/1200	5902062200037
360.0	Jokra	12/1200	4010122360001
100.0	Silberschnitt	12/600	4010122100003
4000.0	Silberschnitt	0/5	-

NÓŽ DO SZKŁA

Glass cutter / Glasmesser / Στεκροpez / Σκληροζ / Üvegvágó / Čuťit sticlä / Nůž na sklo / Rezač na sklo / Nož za steklo / Peilis stiklivi / Stiklgriezis / Kiasilōikur / Επμαζ Topex / Nožič za staklo / Nozic za staklo / Κοπικό εργαλείο γυαλιού / Cuchillo cortador de vidrio / Tagliavetro / Faca para vidro / Couteau à verre / Glasmes



Ref.	☒	EAN
14A710	12/48	5902062501004

PRZYSSAWKA DO SZYB

Suction lifter / Saugnäpffchen für Glas / Присоска для стекла / Присоска до скла / Üvegábrla emelő / Ventuză pentru geamuri / Přísavka na sklo / Prísavka / Priseski za steklo / Siurbtukas langams / Piesūcekņis logiem / Klaasi-iminapp / Смукач за стъкло / Vakuum kara za prozore / Pijavka za šaht / Βεντούζα τζαμιού / Ventosa / Ventosa per vetri / Copo de sucção para janelas / Ventouse à vitres / Zuighouder voor glas



Ref.	Ø [mm]	Fmax [kg]	info	☒	EAN
14A740	120	40	pojedynczy	0/48	5902062147400
14A780	2 x 120	80	podwójny	0/10	5902062147806

PODPORA TELESKOPOWA

Quick support / Teleskopstütze / Опора телескопическая / Опора телескопична / Támasztó / Suport telescopic / Teleskopová podpora / Podpera teleskopická "třetí ruka" / Stega / Teleskopinė atrama / Stute teleskopiska / Teleskoop-tugi / Подпора телескоп. / Teleskopski nastavak / Teleskopski nastavak / Βάση / Soporte telescópico / Supporto telescopico / Suporte telescópico / Support télescopique / Telescopische steun



Ref.	L [mm]	Fmax [kg]	☒	EAN
07A430	165 - 300	50	0/48	5902062941657
07A431	75 - 125	50	0/48	5902062941664

STÓŁ WARSZTATOWY

Work bench / Werkstattbank / Стол-верстак / Верстак / Állítható munkapad / Teighea tîmplărie / Dilenský stůl / Stolik pracovný / Delavniška miza / Darbastalis / Darba galds / Tööpink / Работна маса / Stol radionički / Radni sto / Πάγκος εργασίας / Banco de trabajo / Banco da lavoro / Mesa de oficina / Etabli d'atelier / Werkplaatstafel



Ref.	W [mm]	L [mm]	H [mm]	☒	EAN
07A420	600	240	800	0/1	5902062160829



Dekoratorskie
Decorating
Отделочные



TOPEX

GILOTYNA DO CIĘCIA PANELI

Laminate flooring guillotine cutter / Guillotineschere für Paneels / Резак для панелей / Гильотина для панелей / Laminát padló vágó készülék / Ghilotină de tăiat panouri / Rezačka pro řezání panelů / Gilotina na rezanie panelov / Giljotina za rezanje plošč / Ploščičij plovimo staklės / Giljotina panelų griešanai / Parketigiljotini / Гилотина за рязане на панели / Uredaj za rezanje panela / Mašina za sečenje panela / Κόπτης πλακών πατώματος / Guillotina para cortes de paneles / Attrezzo per il taglio di pannelli / Aparelho p. cortar paineis / Outil de coupe de panneaux stratifiés / Pannelenknipper



Ref.	L [mm]	☒	EAN
16B000	715	0/4	5902062092397

MASZYNA DO PŁYTEK CERAMICZNYCH

Tile cutting machine / Keramikfliesengerät / Плиткорез / Плиткоріз / Csempévágó / Aparat pentru taiat plăci ceramice / Rezací stroj na keramické obkládačky / Rezačka na keramické obkládačky / Stroj za keramične ploščice / Keramiinių plytelių pjaustyklė / Flīžu zāģis / Plaadilõikur keraamilistele plaatidele / Машина за фаянсови плочки / Uredaj za keramičke pločice / Mašina za keramičke pločice / Κόπτης πλακιδίων / Cortador de azulejos / Tagliapiastrelle / Máquina para azulejos cerámicos / Machine de coupe de carrelages céramiques / Tegelsnijder voor ceramiek



Ref.	L [mm]	W [mm]	☒	EAN
16B140	400	160	0/4	5902062220011
16B160	600	160	0/3	5902062220035

MASZYNA DO PŁYTEK CERAMICZNYCH

Tile cutting machine / Keramikfliesengerät / Плиткорез / Плиткоріз / Csempévágó / Aparat pentru taiat plăci ceramice / Rezací stroj na keramické obkládačky / Rezačka na keramické obkládačky / Stroj za keramične ploščice / Keramiinių plytelių pjaustyklė / Flīžu zāģis / Plaadilõikur keraamilistele plaatidele / Машина за фаянсови плочки / Uredaj za keramičke pločice / Mašina za keramičke pločice / Κόπτης πλακιδίων / Cortador de azulejos / Tagliapiastrelle / Máquina para azulejos cerámicos / Machine de coupe de carrelages céramiques / Tegelsnijder voor ceramiek

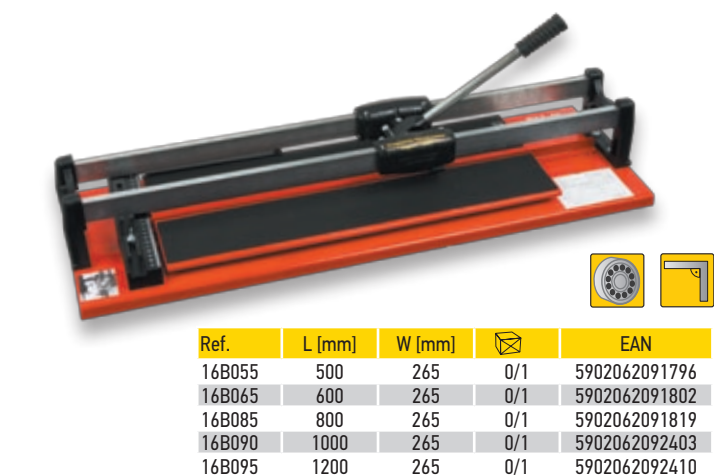

Ref.	L [mm]	W [mm]	☒	EAN
16B055	500	265	0/1	5902062091796
16B065	600	265	0/1	5902062091802
16B085	800	265	0/1	5902062091819
16B090	1000	265	0/1	5902062092403
16B095	1200	265	0/1	5902062092410

MASZYNA DO PŁYTEK CERAMICZNYCH

Tile cutting machine / Keramikfliesengerät / Плиткорез / Плиткоріз / Csempévágó / Aparat pentru taiat plăci ceramice / Rezací stroj na keramické obkládačky / Rezačka na keramické obkládačky / Stroj za keramične ploščice / Keramiinių plytelių pjaustyklė / Flīžu zāģis / Plaadilõikur keraamilistele plaatidele / Машина за фаянсови плочки / Uredaj za keramičke pločice / Mašina za keramičke pločice / Κόπτης πλακιδίων / Cortador de azulejos / Tagliapiastrelle / Máquina para azulejos cerámicos / Machine de coupe de carrelages céramiques / Tegelsnijder voor ceramiek

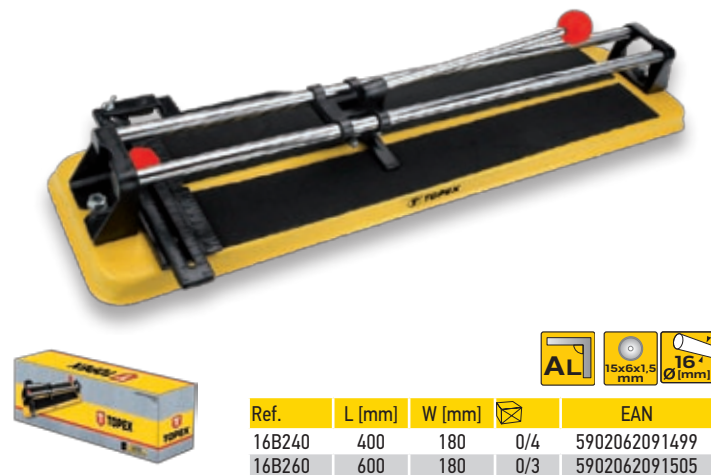

Ref.	L [mm]	W [mm]	☒	EAN
16B240	400	180	0/4	5902062091499
16B260	600	180	0/3	5902062091505

MASZYNA DO PŁYTEK CERAMICZNYCH

Tile cutting machine / Keramikfliesengerät / Плиткорез / Плиткоріз / Csempévágó / Aparat pentru taiat plăci ceramice / Rezací stroj na keramické obkládačky / Rezačka na keramické obkládačky / Stroj za keramične ploščice / Keramiinių plytelių pjaustyklė / Flīžu zāģis / Plaadilõikur keraamilistele plaatidele / Машина за фаянсови плочки / Uredaj za keramičke pločice / Mašina za keramičke pločice / Κόπτης πλακιδίων / Cortador de azulejos / Tagliapiastrelle / Máquina para azulejos cerámicos / Machine de coupe de carrelages céramiques / Tegelsnijder voor ceramiek

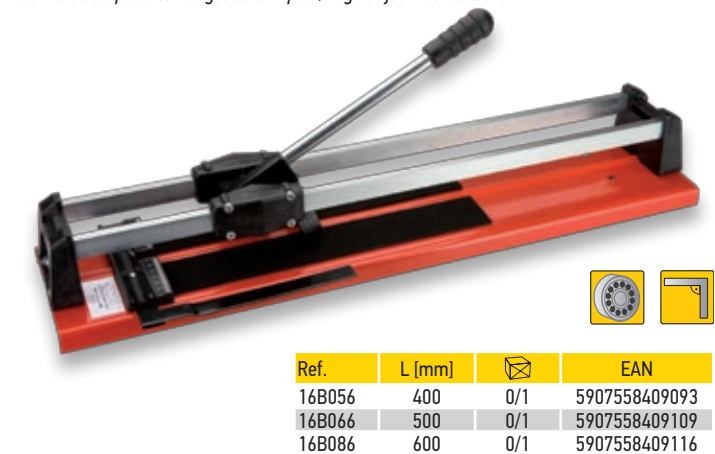

Ref.	L [mm]	☒	EAN
16B056	400	0/1	5907558409093
16B066	500	0/1	5907558409109
16B086	600	0/1	5907558409116

ΚΌΛΕΚΟ ΤΝΑΞΕ

Cutting wheel / Schneiderad / Нож запасной / Ролук рижучий / Vágókerék / Rezerva cutter tevi / Řezné kolečko / Kolesko na rezanie / Rezinlo kolo / Plovimo ratukas / Griezējruļlis / Ketasnuga / Режущее колесо / Rezi kotatič / Тоҷак за резанје / Ράουλο κοπής / Recambio rueda para cortatubos / Ruota di ricambio / Roda substituível / Roue de remplacement / Snijwielen



Ref.	☒	EAN
16B316	do 16B230	0/400 5902062091246
16B318	do 16B240; 16B260	0/400 5902062091253
16B322	do 16B140; 16B160	0/300 5902062091260
16B324	do 16B055-16B085; 16B050-16B080	0/50 5902062204011
16B326	do 16B056-16B086	0/50 5902062205742

NÓŻ DO GLAZURY

Tile knife / Fliesenmesser / Нож для кафельной плитки / Нож для плитки / Kézi csempévágó / Cuijt teracotă / Nůž na glazuru / Nůž na keramiku / Nož za ploščice / Peilis plyteléms / Nazis flizēm / Plaadinuga / Нож за фаянс / Nož za ploščice / Κοπτική λεπίδα για πλακίδια / Cuchillo cortador de azulejos / Coltello per piastrelle / Faca para azulejos / Couteau à carrelage / Glazuurmes

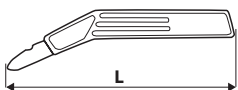

Ref.	L [mm]		EAN
16B420	170	0/50	5902062090232

SKROBAK

Scraper / Kratzer / Скребок / Шерхебель / Rasketta / Rāzātoare / Škrabák / Škrabka / Strgalo / Grandklis / Skrāpis / Kaabits / Шабър / Strugaljka / Spachtla / Ξύστρα / Rasqueta / Raschietto / Rascador / Grattoir / Krabber

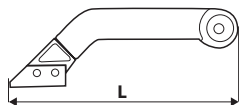

Ref.	L [mm]		EAN
16B471	210	10/60	5902062092045

OSTRZA DO SKROBAKA

Blades for scraper / Klengen für Schraber / Лезвия для скребка / Леза до скребка / Tartalék pengék kaparóhoz / Lame pentru razuitoar / Щепел на шкράбкы / Щепеле до шкράбкы / Rezila za strgalo / Peilii gremžtukui / Skrāpja asmeni / Kraabitsa terad / Оструета за шабър / Oštrice za nožić / Oštrice za strugač / Λάμες για ξύστρα / Hojas para rasqueta / Lame / Lâminas p. Rascadora / Lames à grattoir / Krabberbladen

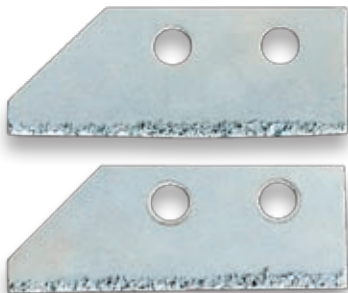

x2

Ref.		EAN
16B471-1	0/400	5902062092205

SZCZYPCE DO GLAZURY

Tile cutting pliers / Fliesenzange / Клеуци для плитки / Щипци для плитки глазурованої / Kézi csempévágó / Clește p/u plăci de teracotă / Kleště na glazuru / Kliešte rezacie a lámacie na obkladačky / Klešče za rezanje ploščic / Replēs plyteléms / Knaibles flizēm / Nāpitsad plaadi lõikamiseks / Клеуци за фаянс / Klijesta za sječenje pločica / Klesta za secenje pločica / Σπάσης Πλακιδίων / Pinzas para azulejos / Pinza per piastrelle / Pinças p. azulejos / Pince à carrelage / Glazuurtang

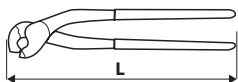

Ref.	L [mm]		EAN
16B440	200	6/36	5902062091482

SZCZYPCE DO GLAZURY

Tile cutting pliers / Fliesenzange / Клеуци для плитки / Щипци для плитки глазурованої / Kézi csempévágó / Clește p/u plăci de teracotă / Kleště na glazuru / Kliešte rezacie a lámacie na obkladačky / Klešče za rezanje ploščic / Replēs plyteléms / Knaibles flizēm / Nāpitsad plaadi lõikamiseks / Клеуци за фаянс / Klijesta za sječenje pločica / Klesta za secenje pločica / Σπάσης Πλακιδίων / Pinzas para azulejos / Pinza per piastrelle / Pinças p. azulejos / Pince à carrelage / Glazuurtang

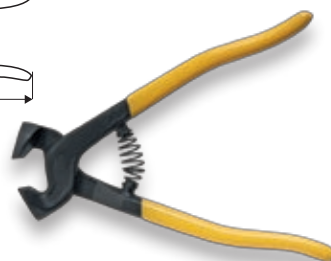
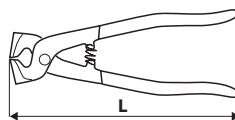

Ref.	L [mm]		EAN
16B441	200	5/50	5902062092212

SZCZYPCE DO GLAZURY

Tile cutting pliers / Fliesenzange / Клеуци для плитки / Щипци для плитки глазурованої / Kézi csempévágó / Clește p/u plăci de teracotă / Kleště na glazuru / Kliešte rezacie a lámacie na obkladačky / Klešče za rezanje ploščic / Replēs plyteléms / Knaibles flizēm / Nāpitsad plaadi lõikamiseks / Клеуци за фаянс / Klijesta za sječenje pločica / Klesta za secenje pločica / Σπάσης Πλακιδίων / Pinzas para azulejos / Pinza per piastrelle / Pinças p. azulejos / Pince à carrelage / Glazuurtang

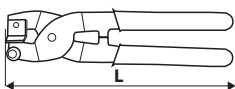

Ref.	L [mm]		EAN
16B430	210	0/60	5902062091277

WYCINARKA OTWORÓW W GLAZURZE

Adjustable hole cutter / Fliesenstichsäge / Сверло для плитки / Викружальник регульований / Kõrkinvågõ csempéhez / Mechanism de reglare perforare găuri / Fréza na díry v glazuře / Vykrúžonák na obkladačky / Urezovalec lukenj v ploščice / Prietaisas ertmivi pjoivimui plytelése / Caurumzāģis / Tellitav augulõikur / Бургуя за фаянс / Podešavajúci Sjekáč / Sekáč za rupe / Ρυθμιζόμενη Πένσα Πλακά / Sacabocado para azulejos / Tagliafori per piastrelle / Serra de contorno para azulejos / Découpeuse d'ouvertures dans le carrelage / Gatenknipper voor glazuur



Ref.	Ø otvoru [mm]		EAN
16B460	40-90	0/50	5902062090270

WYCINARKA OTWORÓW W GLAZURZE

Adjustable hole cutter / Fliesenstichsäge / Сверло для плитки / Викружальник регульований / Kõrkinvågõ csempéhez / Mechanism de reglare perforare găuri / Fréza na díry v glazuře / Vykrúžonák na obkladačky / Urezovalec lukenj v ploščice / Prietaisas ertmivi pjoivimui plytelése / Caurumzāģis / Tellitav augulõikur / Бургуя за фаянс / Podešavajúci Sjekáč / Sekáč za rupe / Ρυθμιζόμενη Πένσα Πλακά / Sacabocado para azulejos / Tagliafori per piastrelle / Serra de contorno para azulejos / Découpeuse d'ouvertures dans le carrelage / Gatenknipper voor glazuur



Ref.	Ø otvoru [mm]		EAN
16B451	40-100	3/36	5902062091536

UCHWYTY MAGNETYCZNE DO PŁYTEK

Magnetic tile holders / Magnetfliesenhalterungen / Держатели магнитные для плиток / Магніти для плитки / Mágneses csempetartó készlet / Dispozitiv magnetic fixare plăci / Magnetické držáky na obkládačky / Uchytky magnetické na obkládačky / Magnetna držala za ploščice / Magnetinis plytelių laikiklis / Turētājs flīzēm magnētisks / Magnetplaatidhoidjad / Шнапери за плочки / Magnetni Držac pločica / Magnetni držac pločica / Μαγνητική θήκη συγκράτησης για πλακίδια / Plaquitas magnéticas de sujeción para azulejos / Prese magnetiche per piastrelle / Suportes magnéticos p. azulejos / Porte-plaquettes magnétiques / Magnetische houders voor tegels



Ref.	☒	EAN
16B480	10/50	5902062202048

SKROBAK

Scraper / Kratzer / Скребок / Шерхбель / Rasketta / Răzătoare / Škrábák / Škrabka / Strgalo / Grandklis / Skrapis / Kaabits / Шабър / Strugaljka / Spahla / Ξύστρα / Rasqueta / Raschietto / Rascador / Grattoir / Krabber

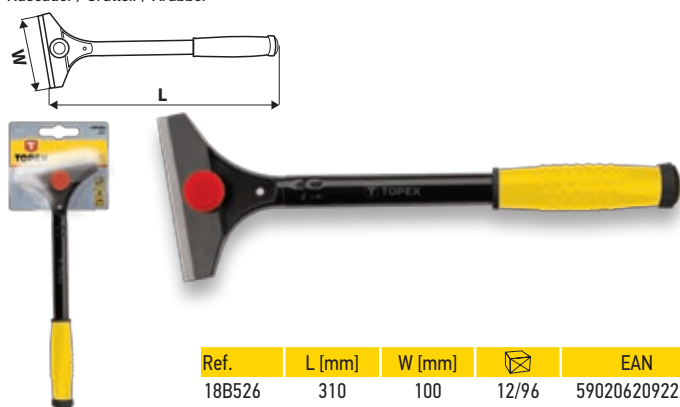

Ref.	L [mm]	W [mm]	☒	EAN
18B526	310	100	12/96	5902062092229

OSTRZA DO SKROBAKA

Blades for scraper / Klengen für Schrabber / Лезвия для скребка / Леза до скребка / Tartalék pengék kararóhoz / Lame pentru raziator / Cepel na škrábku / Cepele do škrabky / Rezila za strgalo / Peililai gremžtukui / Skrapja asmeņi / Kraabitsa terad / Острума за шабър / Oštrice za nožić / Oštrice za strugač / Λames για ξύστρα / Hojas para rasqueta / Lame / Láminas p. Rascadora / Lames à grattoir / Krabberbladen



Ref.	L [mm]	☒	EAN
18B527	100	24/192	5902062092236

FUGOWNICA GUMOWA

Rubber spreader / Gummi-Fugengerät / Шпатель для фуговки / Шпадля гумова / Fugázó gumí / Spaclu pentru rosturi / Stërka pryžová / Gumená stierka / Gumijasto orodje za fugiranje / Guminė glaistyklė, siūlėms / Gumijas lāpstiņa špaktelēšanai / Kummist vuugilabidas / Гумирана мапина за фуѓуране / Gumeni stroj za fugiranje / Uredaj za širenje gume / Σπάτουλα ελαστική / Esparcidor con lengüeta de goma / Attrezzo per giunture / Máquina de pôr junta de borracha / Taloches pour joints en caoutchouc / Rubberen voegpistool

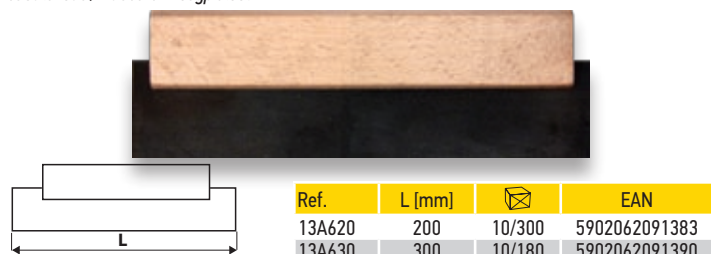

Ref.	L [mm]	☒	EAN
13A620	200	10/300	5902062091383
13A630	300	10/180	5902062091390

KRZYŻYKI DYSTANSOWE

Cross distancers / Abstandskreuze / Крестики / Хрестики дистанційні / Hézagalókereszt / Cruciuliji p/u distantă / Distančni křížky / Křížik distančný / Distančni križci / Kryžiukai plytelėms / Flīžu krustiņi / Ristikilud / Ограничител за фугу / Križiči / Krstici / Αποστασιοποιητές πλακιδίων / Crucetas separadoras para azulejos / Crocette distanziatori / Separador / Entretoises de croix / Afstandskruizen



Ref.	W [mm]	N	☒	EAN
16B515	1.5	x200	0/100	5902062090348
16B520	2	x200	0/100	5902062090355
16B525	2.5	x150	0/100	5902062090362
16B530	3	x150	0/100	5902062090379
16B540	4	x100	0/100	5902062090386
16B550	5	x100	0/100	5902062090393

KRZYŻYKI DYSTANSOWE

Cross distancers / Abstandskreuze / Крестики / Хрестики дистанційні / Hézagalókereszt / Cruciuliji p/u distantă / Distančni křížky / Křížik distančný / Distančni križci / Kryžiukai plytelėms / Flīžu krustiņi / Ristikilud / Ограничител за фугу / Križiči / Krstici / Αποστασιοποιητές πλακιδίων / Crucetas separadoras para azulejos / Crocette distanziatori / Separador / Entretoises de croix / Afstandskruizen

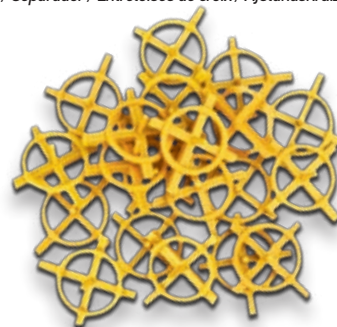

Ref.	W [mm]	N	☒	EAN
16B615	1.5	x100	0/50	5902062091581
16B620	2	x100	0/50	5902062091598
16B630	3	x100	0/50	5902062091604
16B640	4	x100	0/50	5902062091611
16B650	5	x100	0/50	5902062091628

KLINY DYSTANSOWE

Tile wedges / Abstandskeile / Клинья / Клиниј для плитки / Csempék / Pene acoperiş / Distančni kliny / Klin distančný / Distančni klini / Pleištai plytelėms / Distances kilitis / Plaadikiilud / Клиноее / Klin za ploščice / Klin za ploščice / Σφήνες αποστασιοποίησης / Cuñas para azulejos / Cunei distanziatori / Cunhas de distância / Cales d'entretoises / Afstandswiggen



Ref.	W [mm]	N	info	☒	EAN
16B605	35	x50	duže	0/100	5902062091345
16B610	28	x100	mate	0/100	5902062091512

MIESZADŁO DO ZAPRAW

Mortar mixer / Mörtelrührer / Мешалка для растворов / Мішалка до чамуру будівельного / Malterkeverőszár / Mixer ciment / Míchačka malty / Miešac na maltu / Mešalnik za barvo / Maišyklė skiediniui / Mikseris massām / Mōrdisegisti / Бърналка / Mikser za boju / Mikser za boju / Αναδευτήρας κονιάματος / Varilla para mezclador de mortero / Agitatore per malta / Misturador p. Argamassa / Agitateur à mortier / Mortelmixer



Ref.	Ø [mm]	⊠	EAN
22B001	100	0/24	5902062121745
22B002	120	0/16	5902062121752

MIESZADŁO DO ZAPRAW

Mortar mixer / Mörtelrührer / Мешалка для растворов / Мішалка до чамуру будівельного / Malterkeverőszár / Mixer ciment / Míchačka malty / Miešac na maltu / Mešalnik za barvo / Maišyklė skiediniui / Mikseris massām / Mōrdisegisti / Бърналка / Mikser za boju / Mikser za boju / Αναδευτήρας κονιάματος / Varilla para mezclador de mortero / Agitatore per malta / Misturador p. Argamassa / Agitateur à mortier / Mortelmixer



Ref.	Ø [mm]	⊠	EAN
22B010	100	0/24	5902062221162
22B012	120	0/24	5902062221179

MIESZADŁO DO ZAPRAW

Mortar mixer / Mörtelrührer / Мешалка для растворов / Мішалка до чамуру будівельного / Malterkeverőszár / Mixer ciment / Míchačka malty / Miešac na maltu / Mešalnik za barvo / Maišyklė skiediniui / Mikseris massām / Mōrdisegisti / Бърналка / Mikser za boju / Mikser za boju / Αναδευτήρας κονιάματος / Varilla para mezclador de mortero / Agitatore per malta / Misturador p. Argamassa / Agitateur à mortier / Mortelmixer



Ref.	Ø [mm]	⊠	EAN
22B108	80	0/60	5902062121134
22B110	100	0/30	5902062121141

MIESZADŁO DO FARB I KLEJÓW

Paint mixer / Rührer für Farben und Kleber / Мешалка для лакокрасочных материалов / Насадка до змішування фарб і клеїв / Keverőszár festékekhez és ragasztókhöz / Agitator/mixer de vopsele și cleiuri / Míchaadlo na barvy a lepidla / Miešadlo na farby a lepidlá / Mešalo za barve in lepila / Maišyklė dažams ir klėjams / Krāsu un līmju maisītājs / Vārvi- ja liimivispel / Бърначка за бою и лепило / Mješalica za boje i ljepilo / Mešalica za farbu i lepak / Αναδευτήρας χρωμάτων και κόλλας / Varilla para mezclador de pintura y pegamento / Agitatore per vernici / Misturador p. Tintas / Agitateur de peinture / Mixer voor verf en lijm



Ref.	Ø [mm]	⊠	EAN
22B218	80	0/40	5902062120427
22B220	100	20/40	5902062120892

MIESZADŁO DO GIPSU

Plastering mixer / Gipsrührer / Мешалка для гипса / Мішалка до гіпсу / Festékkeverőszár / Mixer ghips / Míchačka sádry / Miesac na sádrú / Mešalnik za gips / Maišyklė gipsui / Mikseris ğipsim / Krohvisegisti / Бърналка / Mikser za boju / Mikser za boju / Αναδευτήρας σοβαντίματος / Varilla para mezclador de yeso / Agitatore per gesso / Misturador p. Gesso / Agitateur à plâtre / Gipsmixer



Ref.	Ø [mm]	⊠	EAN
22B208	80	0/60	5902062121226
22B210	100	0/30	5902062121233

PEZEL MALARSKI

Paint brush / Malerpinsel / Кисть малярная / Пензель мулярський / Ecset / Perie vopsea / Malířský štětec / Štetec maliarsky na akrylové farby / Pleskarski čopič / Teptukas dažymui / Ota krásošani / Maalriversel / Четка / Četka akril / Četka za krecenje / Πινέλο βαφής / Brocha de pintor / Pennellessa / Pincel para pintura / Pinceau de peinture / Verfkwast

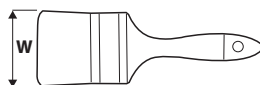

Ref.	W ["]	⊠	EAN
19B610	1	12/960	5902062196101
19B615	1.5	12/600	5902062196156
19B620	2	12/480	5902062196200
19B625	2.5	12/360	5902062196255
19B630	3	12/360	5902062196309
19B640	4	12/240	5902062196408

WAŁEK MALARSKI

Paint roller / Malerwalze / Валик малярный / Валик мулярський / Teddy póthenger / Valț vopsea / Malířský váleček / Valček Maltopren / Pleskarski valjček / Volelis dažymui / Rullitis krásošani / Maalrull / Валик бояджийски / Valjak za bojanje set / Valjak za krecenje / Ρολλό βαφής / Rodillo Maltopren / Rullo da pittore / Rolo p. pintar / Rouleau de peinture / Verfroller

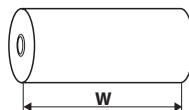

Ref.	W [mm]	⊠	EAN
20B110	50	0/250	5902062751058
20B120	70	0/250	5902062751072
20B130	100	0/200	5902062751102
20B140	150	0/150	5902062751157

ROLKA MALARSKA

Paint roller / Streichrolle / Валик малярный / Валики безворсові малярні / Festöhenger / Rolă de zugrav / Malířský váleček / Maliarsky valček / Pleskarski valj / Dažyma volelis / Krāsošanas veltnītis / Maalirullid / Бояджіўска ролка / Ličička rolca / Molerski valjak / Ρολό βαφής / Rodillo de pintor / Rullo per verniciare / Rolo para pintura / Rouleau de peinture / Verffroller



Ref.	W [mm]	L [mm]	☒	EAN
20B145	50	145	0/60	5902062754059
20B150	70	145	0/60	5902062754073
20B155	100	200	0/60	5902062754103

WAŁEK MALARSKI

Paint roller / Malerwalze / Валик малярный / Валик мулярський / Teddy póthenger / Valť vorsea / Malířský váleček / Valček Moltopren / Pleskarski valjček / Volelis dažymai / Rullītis krāsošanai / Maalirull / Валяк бояджіўскі / Valjak za bojanje set / Valjak za krecenje / Ρολό βαφής / Rodillo de pintor / Rullo da pittore / Rolo p. pintar / Rouleau de peinture / Verffroller

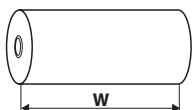

Ref.	W [mm]	☒	EAN
20B215	50	0/250	5902062755056
20B225	70	0/250	5902062755070
20B235	100	0/200	5902062755100
20B245	150	0/150	5902062755155

ROLKA MALARSKA

Paint roller / Streichrolle / Валик малярный / Валики безворсові малярні / Festöhenger / Rolă de zugrav / Malířský váleček / Maliarsky valček / Pleskarski valj / Dažyma volelis / Krāsošanas veltnītis / Maalirullid / Бояджіўска ролка / Ličička rolca / Molerski valjak / Ρολό βαφής / Rodillo de pintor / Rullo per verniciare / Rolo para pintura / Rouleau de peinture / Verffroller



Ref.	W [mm]	info	☒	EAN
20B330	180	z rączką	0/40	5902062766182
20B340	250	z rączką	0/30	5902062766250
20B350	180	z rączką i kratką	0/20	5902062776181
20B360	250	z rączką i kratką	0/30	5902062776259

WAŁEK SZNURKOWY

Paint roller / Welle / Валик малярный / Валик шнурковий / Teddy póthenger / Rolă cu cordoane / Pletený váleček / Plyšový valček / Pleskarski valj / Poliakrilinis volelis / Krāsošanas veltnītis / Nöörullid / Бояджіўскі валяк / Valjak od konopa / Valjak s kaparom / Ρολό βαφής / Rodillo de lana / Rulli / Rolo de corda / Rouleau à corde tressée / Snoerroller

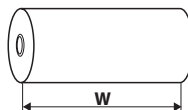

Ref.	W [mm]	☒	EAN
20B450	180	0/20	5902062204509
20B451	250	0/60	5902062204516

WAŁEK SZNURKOWY

Paint roller / Welle / Валик малярный / Валик шнурковий / Teddy póthenger / Rolă cu cordoane / Pletený váleček / Plyšový valček / Pleskarski valj / Poliakrilinis volelis / Krāsošanas veltnītis / Nöörullid / Бояджіўскі валяк / Valjak od konopa / Valjak s kaparom / Ρολό βαφής / Rodillo de lana / Rulli / Rolo de corda / Rouleau à corde tressée / Snoerroller

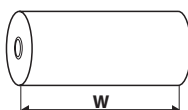

Ref.	W [mm]	☒	EAN
20B415	180	0/20	5902062757197
20B435	250	0/50	5902062757258

WAŁEK SZNURKOWY

Paint roller / Welle / Валик малярный / Валик шнурковий / Teddy póthenger / Rolă cu cordoane / Pletený váleček / Plyšový valček / Pleskarski valj / Poliakrilinis volelis / Krāsošanas veltnītis / Nöörullid / Бояджіўскі валяк / Valjak od konopa / Valjak s kaparom / Ρολό βαφής / Rodillo de lana / Rulli / Rolo de corda / Rouleau à corde tressée / Snoerroller

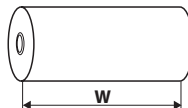

Ref.	W [mm]	☒	EAN
20B425	180	0/50	5902062121325
20B445	250	0/40	5902062121332

ZESTAW MALARSKI

Painter kit / Anstrich-Set / Набор маляра / Набор малярський / Festő készlet / Garnitură de vopsitorie / Malířská sada / Malárska súprava / Komplet za pleskarje / Komplektas dažymui / Krāsotāja komplekts / Maalriekomplekt / Бояджийски комплект / Slikarski set / Pribor za slikanje / Σετ βαφεία / Juego de herramientas para pintar / Set da pittore / Kit p. Pintura / Jeu de peinture / Verfset



x10

Ref.	☒	EAN
20B712	0/20	5902062121646

UCHWYT DO WAŁKÓW

Roller holder / Aufnahme für Wellen / Зажим для валиков / Тримач до валиків / Hengeryél / Suport pentru rulouri / Držák na válečky / Objímka hriadeľov / Ročaj za valje / Volelių rankena / Veltra ietvere / Völlihoidik / Дръжка на фенерче / Drška za valjke / Hvat za valjke / Προσαρμογέας ρόουλων / Sujeción para rodillos / Manico / Supporte de rolos / Manche à rouleaux / Houder voor rollers

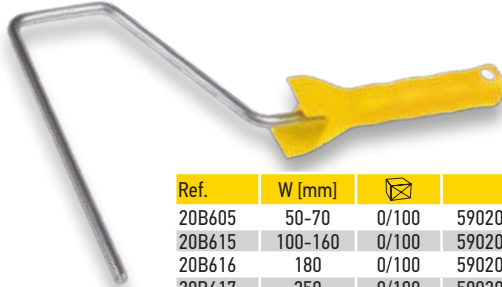

Ø6 (mm)

Ref.	W [mm]	☒	EAN
20B605	50-70	0/100	5902062759054
20B615	100-160	0/100	5902062759108
20B616	180	0/100	5902062206169
20B617	250	0/100	5902062206176

KIJ TELESKOPOWY

Telescopic pole / Teleskopstock / Штанга телескопическая / Ціпок телескопічний / Teddy hosszabbító / Suport telescopic / Teleskopová násada / Rukoväť teleskopická / Teleskopski ročaj / Teleskopinė rankena / Pagarinātājs teleskopisks / Teleskooplatt / Дръжка телескоп. / Teleskopska Ručka / Teleskopska rucka / Τηλεσκοπικός στύλος / Alargo telescópica / Asta telescópica / Pau telescópica / Tige télescopique / Teleskopisch houvast



Ref.	L [m]	Ø [mm]	W [mm]	☒	EAN
20B602	1 - 2	25	0,7	0/20	5902062206022
20B603	1.5 - 3	25	0,7	0/20	5902062206039

KUWETA MALARSKA

Tray / Malerschale / Ванночка малярная / Кювета малярська / Festbedény / Chiuvetă p/u zugravi / Malířská kyveta / Miska maliarska / Pleskarska kadica / Lovelis dažams / Vannite krāsai / Värvivann / Kopumo / Kadica / Kadica / Σκάφη βαφής / Bandeja de plástico para pintura / Bacinella da pittore / Vaso para pintura / Bac de peinture / Verfbak



☒

Ref.	W [cm]	L [cm]	☒	EAN
20B632	26	32	0/40	5902062206329

FOLIA MALARSKA

Covering sheet / Malerfolie / Пленка малярная / Плієнка малярська / Takarófólia / Foaiie încheghere / Malířská fólie / Fólia zákryvacia LDPE / Zaščitna folija / Plēvelē dažymo darbams / Plēve krāsotājam / Katterie / Ποкрытие напйлон / Zašitna folija / Zastitna folija / Φύλλα επικάλυψης / Plástico de protección para pintores / Foglia da pittore / Papel de plástico p. pintura / Film plastique de protection pour la peinture / Schilderfolie



Ref.	W [m]	L [m]	grubość [mm]	☒	EAN
23B145	4	5	0,02	0/20	5902062121660
23B175	4	5	0,007	0/50	5902062121653

WAŁEK DO ODPOWIETRZANIA WYLEWEK

Deaeration roller / Welle zur Entlüftung von Fußböden / Валик игольчатый для наливных полов / Валик голчастий (для наливних поверхонь) / Tűskés légtelenítő henger / Rolă de evacuarea aerului/formatare sara / Odvzdušňovací váleček / Valček na odvzdušňovanie / Valj za odzračevanje / Volelis nuorinimui / Adatu velnītis / Betooniõhutusrull / Иглен обезвъздушаващ валик / Valjak za odzračevanje / Valjak za ventiliranje otvora / Ρολό αφαίρεσης φυσαλίδων / Rodillo anti-burbujas / Rulli / Rolo para retirar ar / Rouleau à désaérer le mortier / Roller voor ontluftung van opstorting



Ref.	L [mm]	wys. kolców [mm]	rodzaj	☒	EAN
20B801	250	14	drobny	0/15	5902062206077
20B802	250	28	gruby	0/10	5902062206084

TAŚMA MALARSKA

Masking tape / Malerband / Лента малярная / Стрічка малярська / Krepp szalag / Bandă de mascare / Malířská páska / Páska krycia / Zaščitni trak / Juosta dažymo darbams / Limlenta krāsotājam / Maalriteip / Τυκσο χαρτιενο / Krepp traka / Krepp traka / Ταϊνία κάλυψης / Cinta de pintor / Nastro da pittore / Fita p. pintura / Bande de peinture / Verfband



Ref.	W [mm]	L [m]	☒	EAN
23B203	30	36	10/40	5902062121165
23B205	38	36	6/24	5902062232052
23B204	48	36	6/24	5902062121172

TAŚMA DWUSTRONNA

Double sided tape / Band, beidseitig / Лента двухсторонняя / Стрічка клейка двобічна / Kétoldalú ragasztószalag / Bandă dublu adezivă/mochete / Oboustranná páska / Obojstranná páska / Dvostranski trak / Dvipusé juosta / Divpusēja līmlente / Каһерәәһәһә теҗ / Двусторонна лента / Dvostrana traka / Dvostrana traka / Αυτοκόλλητη ταινία διπλής όψης / Cinta doble / Nastro incollante doppio / Fita de dois lados / Bande double face / Dubbelzijdige band



Ref.	W [mm]	L [m]	☒	EAN
23B222	50	10	0/48	5902062232229
23B224	50	25	0/24	5902062232243

TAŚMA UNIWERSALNA

Universal tape / Universalband / Лента универсальная / Стрічка универсальна / Ragasztószalag / Bandă universală / Univerzální páska / Páska lepiaca Univerzálna / Univerzalni trak / Univerzali juosta / Lenta universala / Univeraalteip / Тижко армурано / Univerzalna DUCT traka / Univerzalna traka / Ταίνια γενικής χρήσης / Cinta universal reforzada DUCT TAPE / Nastro universale / Fita universal / Bande universelle / Universele band

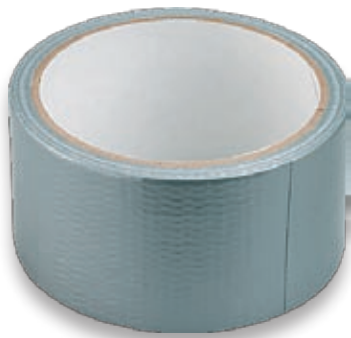

Ref.	W [mm]	L [m]	☒	EAN
24B120	48	9	0/72	5902062241207
24B125	48	45	0/24	5902062241252

TAŚMA OSTRZEGAWCZA

Warning tape / Warnstreifen / Лента оградительная / Стрічка застережна / Jelölőszalag / Bandă de încălzire / Výstražná páska / Páska výstražná / Opozorilni trak / Isprejatoji juosta / Drošības zonas lēna / Soojendusteip / Лента сигнальна / Traka za upozoravanje / Traka za upozoravanje / Αυτοκόλλητη Ταίνια Προειδοποίησης Κινδύνου / Cinta de seguridad / Nastro ammonitore / Fita de advertência / Bande d'avertissement / Waarschuwingsband



Ref.	W [mm]	L [m]	☒	EAN
24B150	80	90	0/36	5902062241504

TAŚMA PAKOWA

Packing tape / Packband / Скотч упаковочный / Шліфмашина стрічкова / Csomagoló ragasztószalag / Bandă pentru ambalat / Balící páska / Baliaća páska / Trak za pakiranje / Pakavimo juosta / Lesainošanas lente / Pakkimisteip / Упаковочна лента / Traka za pakiranje / Traka za pakovanje / Καλλητική ταινία συσκευασίας / Cinta para embalar / Nastro / Fita especial / Bande d'emballage / Verpakkingsband



24B121



24B122

Ref.	W [mm]	L [m]	☒	EAN
24B121	48	35	6/36	5902062241214
24B122	48	35	6/36	5902062130655

WYCISKACZ DO TUB

Caulking gun / Auspresser für Tuben / Выжиматель / Толок для витискування монтажної піни / Kinyomópisztoly kartusokhoz / Comprimator de tuburi / Aplikáční pistole na tuby / Vytlačáč túb / Pištola za tube / Hermetiko pistoletas / Izspiedējs / Toruõmmits / Измускавач за туби / Istiskivač za tube / Istiskivač za tube / Πιστόλι σιλικόνης / Pistola para tubos / Spremitoio / Espremedor para tubos / Pistolet pour tubes / Afdichtingspistool



Ref.	☒	EAN
21B336	0/20	5902062121097

WYCISKACZ DO TUB

Caulking gun / Auspresser für Tuben / Выжиматель / Толок для витискування монтажної піни / Kinyomópisztoly kartusokhoz / Comprimator de tuburi / Aplikáční pistole na tuby / Vytlačáč túb / Pištola za tube / Hermetiko pistoletas / Izspiedējs / Toruõmmits / Измускавач за туби / Istiskivač za tube / Istiskivač za tube / Πιστόλι σιλικόνης / Pistola para tubos / Spremitoio / Espremedor para tubos / Pistolet pour tubes / Afdichtingspistool



Ref.	☒	EAN
21B438	0/30	5902062121080

WYCISKACZ DO TUB

Caulking gun / Auspresser für Tuben / Вьюжиматель / Толок для витискування монтажноі піни / Kinyomópisztoly kartusokhoz / Comprimator de tuburi / Aplikáční pistole na tuby / Vytlačáč tub / Pištola za tube / Hermetiko pistoletas / Izspiedejs / Torutõmmits / Изтискувач за туби / Istiskivač za tube / Istiskivač za tube / Πιστόλι σιλικόνης / Pistola para tubos / Spremitoio / Espremedor para tubos / Pistolet pour tubes / Afdichtingspistool



Ref.	☒	EAN
21B235	0/20	5902062120816

WYCISKACZ DO TUB

Caulking gun / Auspresser für Tuben / Вьюжиматель / Толок для витискування монтажноі піни / Kinyomópisztoly kartusokhoz / Comprimator de tuburi / Aplikáční pistole na tuby / Vytlačáč tub / Pištola za tube / Hermetiko pistoletas / Izspiedejs / Torutõmmits / Изтискувач за туби / Istiskivač za tube / Istiskivač za tube / Πιστόλι σιλικόνης / Pistola para tubos / Spremitoio / Espremedor para tubos / Pistolet pour tubes / Afdichtingspistool



Ref.	☒	EAN
21B245	0/24	5902062120342

WYCISKACZ DO TUB

Caulking gun / Auspresser für Tuben / Вьюжиматель / Толок для витискування монтажноі піни / Kinyomópisztoly kartusokhoz / Comprimator de tuburi / Aplikáční pistole na tuby / Vytlačáč tub / Pištola za tube / Hermetiko pistoletas / Izspiedejs / Torutõmmits / Изтискувач за туби / Istiskivač za tube / Istiskivač za tube / Πιστόλι σιλικόνης / Pistola para tubos / Spremitoio / Espremedor para tubos / Pistolet pour tubes / Afdichtingspistool



Ref.	V [ml]	☒	EAN
21B330	300	0/20	5902062213303
21B360	600	0/20	5902062213600

PISTOLET DO PIANKI MONTAŻOWEJ

Foam gun / Schaumpistole / Пистолет для монтажноі пены / Пистолет до піни монтажноі / Kinyomópisztoly púrhabhoz / Pistol p/u spumä de montare / Pistole pro montážní pěnu / Pištol na montážnu penu / Pištola za montažno peno / Pistoletas sandarinimo putoms / Montāžas putu pistole / Paigaldusvahu pūstol / Пистолет за полуур.пена / Pištolj za pur pjenu / Pištolj za pur penu / Πιστόλι αφρού μονταρίματος / Pistola surtidora de espuma / Pistola per schiuma da montaggio / Pistola p. espuma de montagem / Pistolet à mousse de montage / Pistoal voor montageschuim



Ref.	☒	EAN
21B501	0/20	5902062215017

PISTOLET DO PIANKI MONTAŻOWEJ

Foam gun / Schaumpistole / Пистолет для монтажноі пены / Пистолет до піни монтажноі / Kinyomópisztoly púrhabhoz / Pistol p/u spumä de montare / Pistole pro montážní pěnu / Pištol na montážnu penu / Pištola za montažno peno / Pistoletas sandarinimo putoms / Montāžas putu pistole / Paigaldusvahu pūstol / Пистолет за полуур.пена / Pištolj za pur pjenu / Pištolj za pur penu / Πιστόλι αφρού μονταρίματος / Pistola surtidora de espuma / Pistola per schiuma da montaggio / Pistola p. espuma de montagem / Pistolet à mousse de montage / Pistoal voor montageschuim



Ref.	☒	EAN
21B504	1/20	5902062215048

NOŻ MONTERSKI

Fitter's knife / Monteurmesser / Нож монтерський / Ніж монтерський / Szerelőké / Cutit pentru cabluri / Nůž montérský / Montérsky nůž / Montažni nůž / Montuotojo peilis / Montiera nazis / Elektrikunuga / Монтерски нож / Monterski nůž / Monterski nož / Μαχαίρι ηλεκτρολόγου / Cuchillo recto para cables / Coltello da montatore / Faca p. montagem / Couteau de monteur / Montagemes

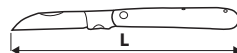

Ref.	L [mm]	☒	EAN
17B632	180	0/30	5902062140241

NÓŽ MONTERSKI

Fitter's knife / Monteurmesser / Нож монтерский / Нож монтерський / Szerelőké / Cutit pentru cabluri / Nůž montérský / Montérsky nôž / Montažni nož / Montuotojo peilis / Montiera nazis / Elektrikunuga / Монтьорски нож / Monterski nož / Monterski nož / Μαχαίρι ηλεκτρολόγου / Cuchillo recto para cables / Coltello da montatore / Faca p. montagem / Couteau de monteur / Montagemes

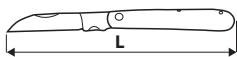

Ref.	L [mm]		EAN
17B656	180	0/25	5902062140265

NÓŽ MONTERSKI

Fitter's knife / Monteurmesser / Нож монтерский / Нож монтерський / Szerelőké / Cutit pentru cabluri / Nůž montérský / Montérsky nôž / Montažni nož / Montuotojo peilis / Montiera nazis / Elektrikunuga / Монтьорски нож / Monterski nož / Monterski nož / Μαχαίρι ηλεκτρολόγου / Cuchillo recto para cables / Coltello da montatore / Faca p. montagem / Couteau de monteur / Montagemes

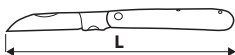

Ref.	L [mm]		EAN
17B658	170	0/25	5902062140272

NÓŽ MONTERSKI

Fitter's knife / Monteurmesser / Нож монтерский / Нож монтерський / Szerelőké / Cutit pentru cabluri / Nůž montérský / Montérsky nôž / Montažni nož / Montuotojo peilis / Montiera nazis / Elektrikunuga / Монтьорски нож / Monterski nož / Monterski nož / Μαχαίρι ηλεκτρολόγου / Cuchillo recto para cables / Coltello da montatore / Faca p. montagem / Couteau de monteur / Montagemes

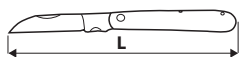

Ref.	L [mm]		EAN
17B639	180	0/15	5902062140258

NÓŽ UNIWERSALNY

Knife / Universalmesser / Нож универсальный / Нож / Zsebkés / Cutit / Univerzální nůž / Nůž univerzálny / Nož / Universalus peilis / Nazis / Nuga / Ножиче / Džepni Nožić / Nož / Μαχαίρι γενικής χρήσης / Cuchillo universal / Coltello universale / Faca universal / Couteau universel / Universele mes



Ref.	L [mm]		EAN
98Z007	80	12/120	5902062140869

NÓŽ UNIWERSALNY

Knife / Universalmesser / Нож универсальный / Нож / Zsebkés / Cutit / Univerzální nůž / Nůž univerzálny / Nož / Universalus peilis / Nazis / Nuga / Ножиче / Džepni Nožić / Nož / Μαχαίρι γενικής χρήσης / Cuchillo universal / Coltello universale / Faca universal / Couteau universel / Universele mes



98Z017



98Z019



Ref.	L [mm]		EAN
98Z017	75	12/72	5902062140654
98Z019	85	12/120	5902062140685

NÓŽ UNIWERSALNY

Knife / Universalmesser / Нож универсальный / Нож / Zsebkés / Cutit / Univerzální nůž / Nůž univerzálny / Nož / Universalus peilis / Nazis / Nuga / Ножиче / Džepni Nožić / Nož / Μαχαίρι γενικής χρήσης / Cuchillo universal / Coltello universale / Faca universal / Couteau universel / Universele mes

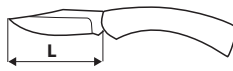

Ref.	L [mm]		EAN
98Z103	120	10/50	5902062981035

NÓŽ UNIWERSALNY

Knife / Universalmesser / Нож универсальный / Нож / Zsebkés / Cutit / Univerzální nůž / Nůž univerzálny / Nož / Universalus peilis / Nazis / Nuga / Ножиче / Džepni Nožić / Nož / Μαχαίρι γενικής χρήσης / Cuchillo universal / Coltello universale / Faca universal / Couteau universel / Universele mes



Ref.	L [mm]		EAN
98Z007	80	12/120	5902062140869

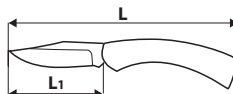

Ref.	L [mm]	L1 [mm]		EAN
98Z101	220	100	12/108	5902062981011

NÓŻ UNIWERSALNY

Knife / Universalmesser / Нож универсальный / Нож / Zsebkés / Cutit / Univerzální nůž / Nůž univerzálny / Nož / Universalus peilis / Nazis / Nuga / Ножиче / Džepni Nožić / Noz / Μαχαίρι γενικής χρήσης / Cuchillo universal / Coltello universale / Faca universal / Couteau universel / Universele mes

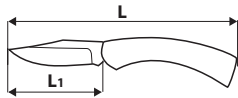

Ref.	L [mm]	L1 [mm]	⊠	EAN
98Z105	185	80	12/108	5902062981059

NÓŻ UNIWERSALNY

Knife / Universalmesser / Нож универсальный / Нож / Zsebkés / Cutit / Univerzální nůž / Nůž univerzálny / Nož / Universalus peilis / Nazis / Nuga / Ножиче / Džepni Nožić / Noz / Μαχαίρι γενικής χρήσης / Cuchillo universal / Coltello universale / Faca universal / Couteau universel / Universele mes

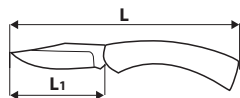

sprężynowa wyrzutnia ostrza



Ref.	L [mm]	L1 [mm]	⊠	EAN
98Z110	205	80	12/108	5902062981103

NÓŻ UNIWERSALNY

Knife / Universalmesser / Нож универсальный / Нож / Zsebkés / Cutit / Univerzální nůž / Nůž univerzálny / Nož / Universalus peilis / Nazis / Nuga / Ножиче / Džepni Nožić / Noz / Μαχαίρι γενικής χρήσης / Cuchillo universal / Coltello universale / Faca universal / Couteau universel / Universele mes

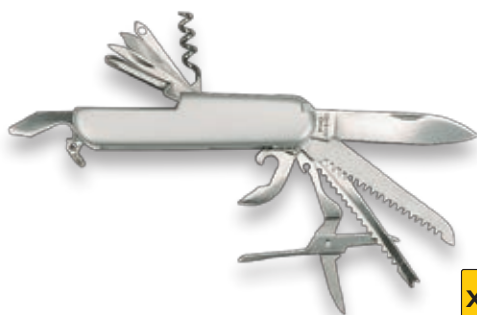

Ref.	⊠	EAN
98Z116	12/108	5902062981158

NÓŻ Z OSTRZEM ŁAMANYM

Snap-off blade knife / Messer m. gebrochener Klinge / Нож с отламывающимся лезвием / Нож з ламаним лезом / Papírvágó kés / Cutit lamă demontabilă / Nůž se zalomeným ostřím / Nožik lámací / Nož / Peilis su nulaužiama geležte / Tapešu nazis / Kokkukäiva teraga nuga / Макемен нож / Skalpel / Skalpel / Koniði «snap Off» / Cúter / Coltello con lama spezzata / Faca com lâmina curvada / Couteau à lame cassable / Mes met gebroken lemmet

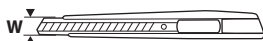

Ref.	W [mm]	D [mm]	⊠	EAN
17B109	9	0,40	50/400	5902062140791

NÓŻ Z OSTRZEM ŁAMANYM

Snap-off blade knife / Messer m. gebrochener Klinge / Нож с отламывающимся лезвием / Нож з ламаним лезом / Papírvágó kés / Cutit lamă demontabilă / Nůž se zalomeným ostřím / Nožik lámací / Nož / Peilis su nulaužiama geležte / Tapešu nazis / Kokkukäiva teraga nuga / Макемен нож / Skalpel / Skalpel / Koniði «snap Off» / Cúter / Coltello con lama spezzata / Faca com lâmina curvada / Couteau à lame cassable / Mes met gebroken lemmet



Ref.	W [mm]	D [mm]	⊠	EAN
17B101	18	0,50	12/72	5902062140968

NÓŻ Z OSTRZEM ŁAMANYM

Snap-off blade knife / Messer m. gebrochener Klinge / Нож с отламывающимся лезвием / Нож з ламаним лезом / Papírvágó kés / Cutit lamă demontabilă / Nůž se zalomeným ostřím / Nožik lámací / Nož / Peilis su nulaužiama geležte / Tapešu nazis / Kokkukäiva teraga nuga / Макемен нож / Skalpel / Skalpel / Koniði «snap Off» / Cúter / Coltello con lama spezzata / Faca com lâmina curvada / Couteau à lame cassable / Mes met gebroken lemmet

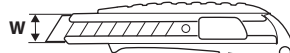

Ref.	W [mm]	D [mm]	⊠	EAN
17B128	18	0,50	12/72	5902062140784

NÓŻ Z OSTRZEM ŁAMANYM

Snap-off blade knife / Messer m. gebrochener Klinge / Нож с отламывающимся лезвием / Нож з ламаним лезом / Papírvágó kés / Cutit lamă demontabilă / Nůž se zalomeným ostřím / Nožik lámací / Nož / Peilis su nulaužiama geležte / Tapešu nazis / Kokkukäiva teraga nuga / Макемен нож / Skalpel / Skalpel / Koniði «snap Off» / Cúter / Coltello con lama spezzata / Faca com lâmina curvada / Couteau à lame cassable / Mes met gebroken lemmet



Ref.	W [mm]	D [mm]	⊠	EAN
17B118	18	0,50	40/160	5902062140692

NÓŻ Z OSTRZEM ŁAMANYM

Snap-off blade knife / Messer m. gebrochener Klinge / Нож с отламывающимся лезвием / Нож з ламаним лезом / Papírvágó kés / Cutit lamă demontabilă / Nůž se zalomeným ostřím / Nožik lámací / Nož / Peilis su nulaužiama geležte / Tapešu nazis / Kokkukäiva teraga nuga / Макемен нож / Skalpel / Skalpel / Koniði «snap Off» / Cúter / Coltello con lama spezzata / Faca com lâmina curvada / Couteau à lame cassable / Mes met gebroken lemmet



Ref.	W [mm]	D [mm]	⊠	EAN
17B168	18	0,50	12/144	5902062140883

NÓŽ Z OSTRZEM ŁAMANYM

Snap-off blade knife / Messer m. gebrochener Klinge / Нож с отламывающимся лезвием / Ніж з ламаним лезом / Papírvágó kés / Cutit lamă demontabilă / Nůž se zalomeným ostřím / Nožik lámací / Nož / Peilis su nulauziama geležte / Tapešu nazis / Kokkukäiiva teraga nuga / Мачетен нож / Skalpel / Skalpel / Koniči «snap Off» / Cúter / Coltello con lama spezzata / Faca com lâmina curvada / Couteau à lame cassable / Mes met gebroken lemmet

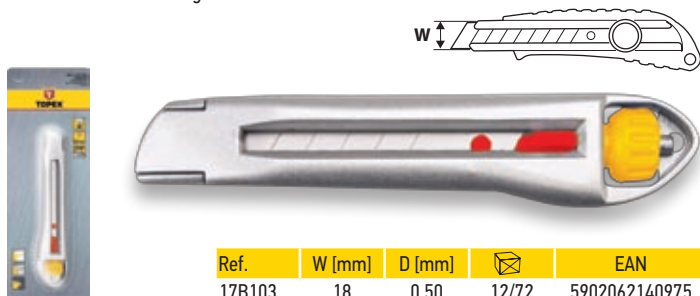

Ref.	W [mm]	D [mm]	☒	EAN
17B103	18	0,50	12/72	5902062140975

NÓŽ Z OSTRZEM ŁAMANYM

Snap-off blade knife / Messer m. gebrochener Klinge / Нож с отламывающимся лезвием / Ніж з ламаним лезом / Papírvágó kés / Cutit lamă demontabilă / Nůž se zalomeným ostřím / Nožik lámací / Nož / Peilis su nulauziama geležte / Tapešu nazis / Kokkukäiiva teraga nuga / Мачетен нож / Skalpel / Skalpel / Koniči «snap Off» / Cúter / Coltello con lama spezzata / Faca com lâmina curvada / Couteau à lame cassable / Mes met gebroken lemmet

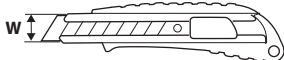

Ref.	W [mm]	D [mm]	☒	EAN
17B428	18	0,50	12/144	5902062140890

NÓŽ Z OSTRZEM ŁAMANYM

Snap-off blade knife / Messer m. gebrochener Klinge / Нож с отламывающимся лезвием / Ніж з ламаним лезом / Papírvágó kés / Cutit lamă demontabilă / Nůž se zalomeným ostřím / Nožik lámací / Nož / Peilis su nulauziama geležte / Tapešu nazis / Kokkukäiiva teraga nuga / Мачетен нож / Skalpel / Skalpel / Koniči «snap Off» / Cúter / Coltello con lama spezzata / Faca com lâmina curvada / Couteau à lame cassable / Mes met gebroken lemmet

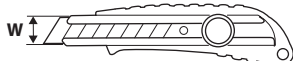

Ref.	W [mm]	D [mm]	☒	EAN
17B490	25	0,75	12/96	5902062141064

NÓŽ Z OSTRZEM TRAPEZOWYM

Knife with utility blade / Messer mit Trapezklinge / Нож с трапецевидным лезвием / Ніж з трапецевидним вістрям / Trapézpengés kés / Cutter cu tăiş trapezoidal / Nůž s trapézovým ostřím / Nůž s trapézovou čepelou / Nož s trapeznim rezilom / Peilis su trapecine geležte / Nazis ar trapecveida asmeni / Trapetsteraga nuga / Нож с трапецовидно острие / Nož s trapezastom ostricom / Nož sa trapezastom ostricom / Μαχαίρι με τραπέζοειδή ακμή / Cúter con hoja trapezoidal / Coltello / Faca com Láminas de trapézio / Couteau à lame trapézoidale / Trapezium mes

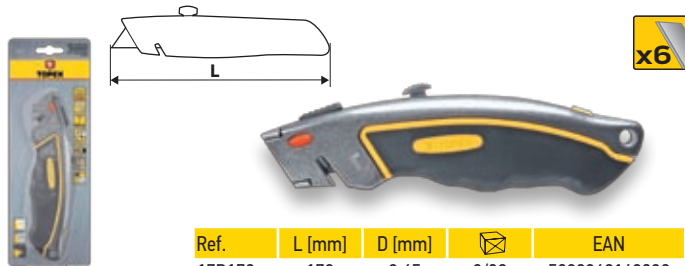

Ref.	L [mm]	D [mm]	☒	EAN
17B172	170	0,65	8/32	5902062140982

NÓŽ Z OSTRZEM TRAPEZOWYM

Knife with utility blade / Messer mit Trapezklinge / Нож с трапецевидным лезвием / Ніж з трапецевидним вістрям / Trapézpengés kés / Cutter cu tăiş trapezoidal / Nůž s trapézovým ostřím / Nůž s trapézovou čepelou / Nož s trapeznim rezilom / Peilis su trapecine geležte / Nazis ar trapecveida asmeni / Trapetsteraga nuga / Нож с трапецовидно острие / Nož s trapezastom ostricom / Nož sa trapezastom ostricom / Μαχαίρι με τραπέζοειδή ακμή / Cúter con hoja trapezoidal / Coltello / Faca com Láminas de trapézio / Couteau à lame trapézoidale / Trapezium mes

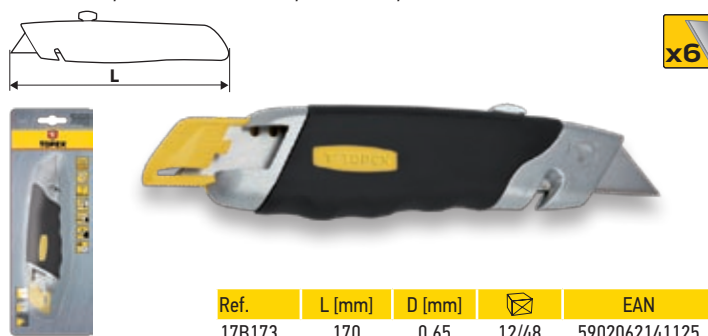

Ref.	L [mm]	D [mm]	☒	EAN
17B173	170	0,65	12/48	5902062141125

NÓŽ Z OSTRZEM TRAPEZOWYM

Knife with utility blade / Messer mit Trapezklinge / Нож с трапецевидным лезвием / Ніж з трапецевидним вістрям / Trapézpengés kés / Cutter cu tăiş trapezoidal / Nůž s trapézovým ostřím / Nůž s trapézovou čepelou / Nož s trapeznim rezilom / Peilis su trapecine geležte / Nazis ar trapecveida asmeni / Trapetsteraga nuga / Нож с трапецовидно острие / Nož s trapezastom ostricom / Nož sa trapezastom ostricom / Μαχαίρι με τραπέζοειδή ακμή / Cúter con hoja trapezoidal / Coltello / Faca com Láminas de trapézio / Couteau à lame trapézoidale / Trapezium mes

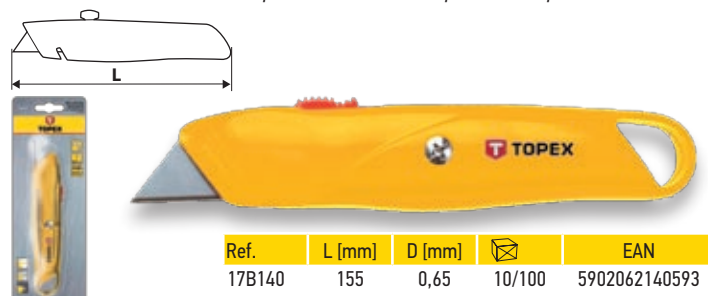

Ref.	L [mm]	D [mm]	☒	EAN
17B140	155	0,65	10/100	5902062140593

NÓŽ Z OSTRZEM TRAPEZOWYM

Knife with utility blade / Messer mit Trapezklinge / Нож с трапецевидным лезвием / Ніж з трапецевидним вістрям / Trapézpengés kés / Cutter cu tăiş trapezoidal / Nůž s trapézovým ostřím / Nůž s trapézovou čepelou / Nož s trapeznim rezilom / Peilis su trapecine geležte / Nazis ar trapecveida asmeni / Trapetsteraga nuga / Нож с трапецовидно острие / Nož s trapezastom ostricom / Nož sa trapezastom ostricom / Μαχαίρι με τραπέζοειδή ακμή / Cúter con hoja trapezoidal / Coltello / Faca com Láminas de trapézio / Couteau à lame trapézoidale / Trapezium mes



Ref.	L [mm]	D [mm]	☒	EAN
17B160	175	0,65	6/36	5902062140913

NÓŽ Z OSTRZEM TRAPEZOWYM

Knife with utility blade / Messer mit Trapezklinge / Нож с трапецевидным лезвием / Ніж з трапецевидним вістрям / Trapézpengés kés / Cutter cu tăiş trapezoidal / Nůž s trapézovým ostřím / Nůž s trapézovou čepelou / Nož s trapeznim rezilom / Peilis su trapecine geležte / Nazis ar trapecveida asmeni / Trapetsteraga nuga / Нож с трапецовидно острие / Nož s trapezastom ostricom / Nož sa trapezastom ostricom / Μαχαίρι με τραπέζοειδή ακμή / Cúter con hoja trapezoidal / Coltello / Faca com Láminas de trapézio / Couteau à lame trapézoidale / Trapezium mes

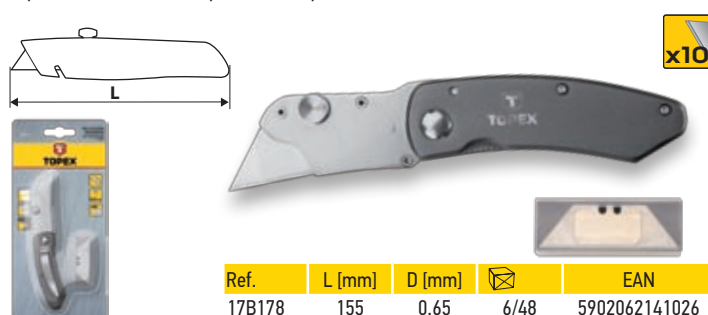

Ref.	L [mm]	D [mm]	☒	EAN
17B178	155	0,65	6/48	5902062141026

NÓŽ MODELARSKI, 3 OSTRZA

Precision knife, 3 blades / Messer, 3 Klängen für Modellbauzwecke / Нож моделиста, 3 лезвия / Нож моделиста, 3 вістря / Modellező kés három pengével / Cutit de modelat, 3 lame / Modelářský nůž, 3 bity / Modelársky nůž, 3 čepele / Modelarski nož, 3 rezila / Modelavimo peilis, 3 geležtės / Modelēšanas nazis, 3 asmeņi / Hobinuga, 3 tera / Моделлерски нож, 3 остриета / Rezbarski nož, 3 ostrice / Modelarski nož, 3 ostrice / Μαχαίρι μοντελισμού, 3 λεπίδες / Cuchillo de precisión, 3 hojas / Colltelo da modellista / Faca de modelação / Couteau de modelage / Precisie mes, 3 lemneten

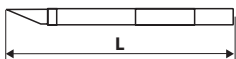

Ref.	L [mm]	☒	EAN
17B703	155	24/288	5902062141040

NOŻYCKI

Scissors / Schere / Ножницы / Ножуци / Olló / Foarfeca / Nůžky / Nožnice / Škarje / Peiliukai / Grieznes / Käährd / Ножуци / Škare / Makaze / Ψαλίδια / Tijeras / Forbici / Tesoura / Ciseaux / Schaar



Ref.	L [mm]	☒	EAN
17B714	140	12/188	5902062177148
17B722	220	12/144	5902062177223

OSTRZA ŁAMANE

Snap off blades / Klängen, abbrechbar / Лезвия сменные отламывающиеся / Леза змінні, що обламуються / Törhető pengék / Lame cutter / Odlatovací čepele / Odlatovacie čepele / Lomljiva rezila / Laužomi peiliukai / Mainātie nolaužamie asmeņi / Vaibanao terad / Отчужаюци се остриета / Lomljene ostrice / Lomljene ostrice / Αποσπώμενες λεπίδες / Hojas segmentadas / Lame / Láminas curvadas / Lames coupées / Gebogen bladen

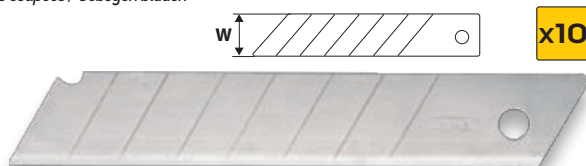

Ref.	W [mm]	D [mm]	☒	EAN
17B349	9	0,40	48/480	5902062140289
17B348	18	0,50	30/240	5902062140296

OSTRZA ŁAMANE

Snap off blades / Klängen, abbrechbar / Лезвия сменные отламывающиеся / Леза змінні, що обламуються / Törhető pengék / Lame cutter / Odlatovací čepele / Odlatovacie čepele / Lomljiva rezila / Laužomi peiliukai / Mainātie nolaužamie asmeņi / Vaibanao terad / Отчужаюци се остриета / Lomljene ostrice / Lomljene ostrice / Αποσπώμενες λεπίδες / Hojas segmentadas / Lame / Láminas curvadas / Lames coupées / Gebogen bladen

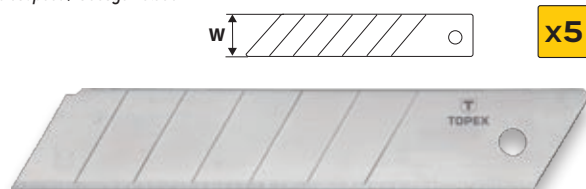

Ref.	W [mm]	D [mm]	☒	EAN
17B550	25	0,75	0/120	5902062141071

OSTRZA TRAPEZOWE

Knife blades / Trapezklängen / Лезвия трапецевидные / Леза ножови / Pvc penge / Cutit lamä / Lichoběžňkové ostří / Ostrie lichoběžňkové / Nadomestna rezila / Keičiamos geležtės / Naža asmeņi / Noaterad / Ostrue rezervo / Nožiči za skalpel / Nožici za skalpel / Ανταλλακτικές λεπίδες / Hojas trapezoidales / Lame trapezoidali / Láminasde trapézio / Tranchants trapézoidaux / Trapezium mesbladen

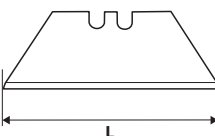

Ref.	L [mm]	D [mm]	☒	EAN
17B405	51	0,40	0/500	5902062140302

OSTRZA WYMIENNE

Knife blades / Wechselklängen / Лезвия сменные / Леза ножови / Pvc penge / Cutit lamä / Vyměnitelné ostří / Ostrie lámacie / Nadomestno rezilo / Keičiamos geležtės / Naža asmeņi / Noaterad / Ostrue rezervo / Nožiči za skalpel / Nožici za skalpel / Ανταλλακτικές λεπίδες / Hojas de repuesto / Lame di ricambio / Láminas substituíveis / Lames de remplacement / Vervangmesbladen

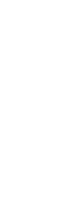
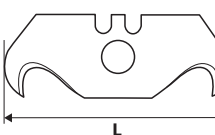

Ref.	L [mm]	D [mm]	☒	EAN
17B2H5	51	0,65	60/600	5902062140739

OSEŁKA

Whetstone / Schleifstein / Брусок точильный / Точила / Fenókö / Piatră abrazivă / Brousek / Osla / Osla / Galgštuvus / Galoda / Luisk / Брус / Brus / Brus / Πέτρα ακονίσματος / Taco de lijar / Pietra per affilare / Pedra de amolar / Pierre à aiguiser / Slijpsteen

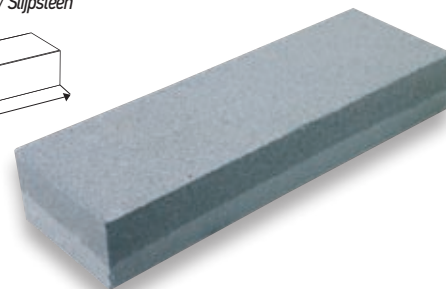
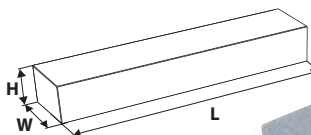

Ref.	W [mm]	L [mm]	H [mm]	gradacija	☒	EAN
17B815	50	150	25	K200/K100	0/50	5902062208255

OSEŁKA

Whetstone / Schleifstein / Брусок точильный / Точила / Fenókö / Piatră abrazivă / Brousek / Osla / Osla / Galgštuvus / Galoda / Luisk / Брус / Brus / Brus / Πέτρα ακονίσματος / Taco de lijar / Pietra per affilare / Pedra de amolar / Pierre à aiguiser / Slijpsteen

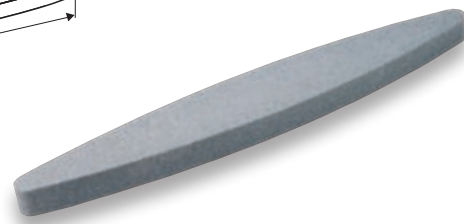
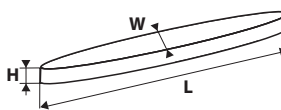

Ref.	W [mm]	L [mm]	H [mm]	gradacija	☒	EAN
17B818	35	230	13	K180	0/100	5902062210432



Pomiarowe
Measuring
Измерительные



TOPEX

MIARA ZWIJANA

Pocket rule / Wickelmessband / Рулетка / Рулетка / Mérőszalag / Ruletă de măsurat / Měřidlo svinovací / Meter rolovací / Meter / Ruletë pëllëninë / Mërlente rulete / Taskujoonlaud / Panemka / Metar / Metar / Σπειρούμενη μετρητική ταινία / Flexómetro / Misura pieghevole / Medidor enrolado / Mesure enroulée / Meetlat

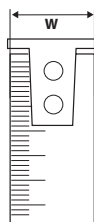

Ref.	L [m]	W [mm]	☒	EAN
27C363	3	19	12/72	5902062273635
27C365	5	25	12/72	5902062273659

MIARA ZWIJANA

Pocket rule / Wickelmessband / Рулетка / Рулетка / Mérőszalag / Ruletă de măsurat / Měřidlo svinovací / Meter rolovací / Meter / Ruletë pëllëninë / Mërlente rulete / Taskujoonlaud / Panemka / Metar / Metar / Σπειρούμενη μετρητική ταινία / Flexómetro / Misura pieghevole / Medidor enrolado / Mesure enroulée / Meetlat

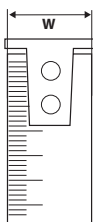

Ref.	L [m]	W [mm]	☒	EAN
27C302	2	16	10/100	5902062111760
27C303	3	16	10/100	5902062111777
27C305	5	19	10/100	5902062111784
27C308	8	25	6/48	5902062111791
27C310	10	25	6/48	5902062111807

MIARA ZWIJANA

Pocket rule / Wickelmessband / Рулетка / Рулетка / Mérőszalag / Ruletă de măsurat / Měřidlo svinovací / Meter rolovací / Meter / Ruletë pëllëninë / Mërlente rulete / Taskujoonlaud / Panemka / Metar / Metar / Σπειρούμενη μετρητική ταινία / Flexómetro / Misura pieghevole / Medidor enrolado / Mesure enroulée / Meetlat

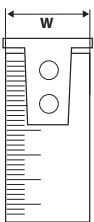

Ref.	L [m]	W [mm]	☒	EAN
27C373	3	16	12/120	5902062112378
27C375	5	22	12/72	5902062112385

MIARA ZWIJANA

Pocket rule / Wickelmessband / Рулетка / Рулетка / Mérőszalag / Ruletă de măsurat / Měřidlo svinovací / Meter rolovací / Meter / Ruletë pëllëninë / Mërlente rulete / Taskujoonlaud / Panemka / Metar / Metar / Σπειρούμενη μετρητική ταινία / Flexómetro / Misura pieghevole / Medidor enrolado / Mesure enroulée / Meetlat

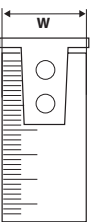

Ref.	L [m]	W [mm]	☒	EAN
27C383	3	16	12/120	5902062273833
27C385	5	19	12/120	5902062273857
27C387	7,5	25	6/72	5902062273871

NARZĘDZIA RĘCZNE / POMIAROWE

MIARA ZWIJANA

Pocket rule / Wickelmessband / Рулетка / Рулетка / Mérőszalag / Ruletă de măsurat / Měřidlo svinovací / Meter rolovací / Meter / Ruletë pëllëninë / Mërlente rulete / Taskujoonlaud / Panemka / Metar / Metar / Σπειρούμενη μετρητική ταινία / Flexómetro / Misura pieghevole / Medidor enrolado / Mesure enroulée / Meetlat

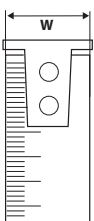

Ref.	L [m]	W [mm]	☒	EAN
27C342	2	16	12/120	5902062273420
27C343	3	19	12/120	5902062273437
27C345	5	25	12/72	5902062273451
27C340	10	32	6/48	5902062273406

TAŚMA MIERNICZA

Measuring tape / Messband / Измерительная лента / Стричка мірна / Mérőszalag / Ruletă / Měřicí páska / Meracia páska / Merilni trak / Metras / Mërlente / Mõõdulint / Мерна лента / Traka za mjerenje / Traka za merenje / Μετροταινία / Cinta larga / Misura / Fita de medição / Ruban de mesure / Meetband

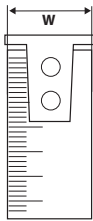

Ref.	L [m]	W [mm]	☒	EAN
28C422	20	13	0/30	5902062284228
28C423	30	13	0/30	5902062284235

TAŚMA MIERNICZA

Measuring tape / Messband / Измерительная лента / Стрічка мірна / Mérőszalag / Ruletă / Měřicí páska / Meracia páska / Merilni trak / Metras / Mērlente / Mõõdulint / Мерна лента / Traka za mjerenje / Traka za merenje / Μετροταινία / Cinta larga / Misura / Fita de medição / Ruban de mesure / Meetband

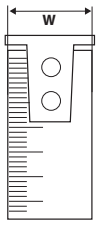

STEEL

Ref.	L [m]	W [mm]	☒	EAN
28C412	20	12,5	4/40	5902062112149
28C413	30	12,5	5/40	5902062112156

TAŚMA MIERNICZA

Measuring tape / Messband / Измерительная лента / Стрічка мірна / Mérőszalag / Ruletă / Měřicí páska / Meracia páska / Merilni trak / Metras / Mērlente / Mõõdulint / Мерна лента / Traka za mjerenje / Traka za merenje / Μετροταινία / Cinta larga / Misura / Fita de medição / Ruban de mesure / Meetband

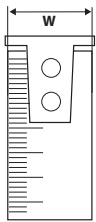

STEEL

Ref.	L [m]	W [mm]	☒	EAN
28C450	50	10	0/10	5902062112019

TAŚMA MIERNICZA

Measuring tape / Messband / Измерительная лента / Стрічка мірна / Mérőszalag / Ruletă / Měřicí páska / Meracia páska / Merilni trak / Metras / Mērlente / Mõõdulint / Мерна лента / Traka za mjerenje / Traka za merenje / Μετροταινία / Cinta larga / Misura / Fita de medição / Ruban de mesure / Meetband

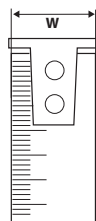

Ref.	L [m]	W [mm]	☒	EAN
28C533	30	13	0/10	5902062285331



TAŚMA MIERNICZA

Measuring tape / Messband / Измерительная лента / Стрічка мірна / Mérőszalag / Ruletă / Měřicí páska / Meracia páska / Merilni trak / Metras / Mērlente / Mõõdulint / Мерна лента / Traka za mjerenje / Traka za merenje / Μετροταινία / Cinta larga / Misura / Fita de medição / Ruban de mesure / Meetband

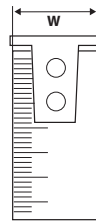

Ref.	L [m]	W [mm]	☒	EAN
28C550	50	13	0/20	5902062111289
28C551	100	13	0/10	5902062111975

POZIOMNICA

STABILA

Sprit level / Richtwaage / Уровень / Рівень / Vízmérték / Nivel spring / Vodováha / Vodováha / Libela / Gulsčiukas aliumininis / Limegrädis / Lood / Huoenup / Libela / Libela / Αλφάδι / Nivel / Linea di livello / Nivel / Nivelle / Staand waterpas

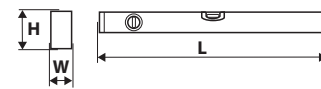

Ref.	L [cm]	H [mm]	W [mm]	☒	EAN
70EN40	40	48	20	0/1	4005069022822
70EN60	60	48	20	0/1	4005069022846
70EN80	80	48	20	0/1	4005069022860
70EN100	100	48	20	0/1	4005069022884
70EN120	120	48	20	0/1	4005069022891
70EN150	150	48	20	0/1	4005069022907
70EN200	200	48	20	0/1	4005069028701

POZIOMNICA

Sprit level / Richtwaage / Уровень / Рівень / Vízmérték / Nivel spring / Vodováha / Vodováha / Libela / Gulsčiukas aliumininis / Limegrädis / Lood / Huoenup / Libela / Libela / Αλφάδι / Nivel / Linea di livello / Nivel / Nivelle / Staand waterpas

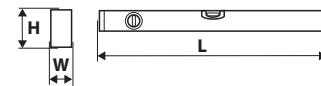

Ref.	L [cm]	H [mm]	W [mm]	☒	EAN
29C301	40	50	20	0/50	5902062293015
29C302	60	50	20	0/50	5902062293022
29C303	80	50	20	0/50	5902062293039
29C304	100	50	20	0/20	5902062293046
29C305	120	50	20	0/20	5902062293053
29C306	150	50	20	0/20	5902062293060
29C307	200	50	20	0/10	5902062293077

POZIOMNICA

Sprit level / Richtwaage / Уровень / Рівень / Vízmerő / Nivel spring / Vodováha / Vodováha / Libela / Gulsčiukas aliumininis / Līmeņrādis / Lood / Нивелур / Libela / Libela / Αλφάδι / Nivel / Linea di livello / Nivel / Nivelle / Staand waterpas



AL

2x



Ref.	L [cm]	H [mm]	W [mm]	☒	EAN
29C501	40	49	19	0/25	4008027040012
29C502	60	49	19	0/25	4008027040029
29C503	80	49	19	0/25	4008027040036
29C504	100	49	19	0/25	4008027040043
29C505	120	49	19	0/25	4008027040050
29C506	150	49	19	0/20	4008027040067
29C507	200	49	19	0/10	4008027040074

POZIOMNICA

Sprit level / Richtwaage / Уровень / Рівень / Vízmerő / Nivel spring / Vodováha / Vodováha / Libela / Gulsčiukas aliumininis / Līmeņrādis / Lood / Нивелур / Libela / Libela / Αλφάδι / Nivel / Linea di livello / Nivel / Nivelle / Staand waterpas



AL

3x

4x

5x

Ref.	L [cm]	H [mm]	W [mm]	☒	EAN
29C602	60	53	24	0/25	5902062112064
29C603	80	53	24	0/25	5902062112071
29C604	100	53	24	0/25	5902062112088
29C605	120	53	24	0/25	5902062112095
29C606	150	53	24	0/20	5902062112101
29C607	200	53	24	0/10	5902062112118

POZIOMNICA

Sprit level / Richtwaage / Уровень / Рівень / Vízmerő / Nivel spring / Vodováha / Vodováha / Libela / Gulsčiukas aliumininis / Līmeņrādis / Lood / Нивелур / Libela / Libela / Αλφάδι / Nivel / Linea di livello / Nivel / Nivelle / Staand waterpas



0° 1,5° 3,5° 45° 90°

5x



Ref.	L [cm]	H [mm]	W [mm]	☒	EAN
29C882	60	60	30	0/50	5902062888822
29C883	80	60	30	0/50	5902062888839
29C884	100	60	30	0/50	5902062888846

POZIOMNICA

Sprit level / Richtwaage / Уровень / Рівень / Vízmerő / Nivel spring / Vodováha / Vodováha / Libela / Gulsčiukas aliumininis / Līmeņrādis / Lood / Нивелур / Libela / Libela / Αλφάδι / Nivel / Linea di livello / Nivel / Nivelle / Staand waterpas

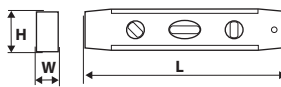

3x

2x

Ref.	L [cm]	H [mm]	W [mm]	☒	EAN
29C894	23	40	12	12/120	5902062880024

POZIOMNICA DO SŁUPKÓW

Post level / Wasserwaage für Pfähle / Уровень складной магнитный с шарниром / Рівень складний магнітний з шарніром / Oszlop vízmerő / Nivelă pentru montante / Slovrková vodováha / Stříkáková vodováha / Libela za drogove / Kampinis gulsčiukas / Saliekamais magnēta līmeņrādis ar šarnīru / Postilood / Лібела за стълбове / Libela za stupove / Libela za stubove / Μαγνητικό αλφάδι σωλήνων / Nivel para postes / Linea di livello / Nivel / Nivelle à poteaux / Palenwaterpas



15-180°

4x

Ref.	info	☒	EAN
29C897	15-180°	0/100	5902062880154

POZIOMNICA SZNURKOWA

String level / Schnur-Richtwaage / Уровень подвесной / Рівень шнурковий / Zsinór vízmerő / Nivelă cu sfoară / Šňůrová vodováha / Snúrová vodováha / Libela z vrnico / Virvinis gulsčiukas / Piekaramais līmeņrādis / Nöörlood / Нушиков нивелур / Libela od koporca / Libela od kapara / Αλφάδι νήματος / Nivel de cuerda / Linea di livello / Nivel de corda / Nivelle à fil / Snoerwaterpas



Ref.	L [m]	☒	EAN
29C891	20	20/100	5902062880215

POZIOMNICA WODNA

Water level / Wasserwaage / Гидроуровень / Рівень водяний / Tamlós vízmérték / Nivelă cu apă / Vodováha / Vodováha / Vodna libela / Vandens gulsčiukas / Ūdens līmeņrādis / Vesilood / Воден нивелур / Vodena libela / Lubela vodena / Υδραυλικό αλφάδι / Nivel de agua / Linea di livello / Nivel de água / Nivelée à eau / Waterpas



Ref.	L [m]	☒	EAN
29C871	15	0/10	5902062111982
29C872	20	0/10	5902062111999
29C873	25	0/10	5902062112002

ŁATA MURARSKA

Traversing rule / Richtscheit / Правило строительное / Рейки мулярські / Őlesléc / Dreptar (calapod) / Zednická lat' / Lata murárska / Zidarska letev / Liniuotė mūrininkui / Mūrnieka trapece / Joonlaud / Маслар / Specjalna libela / Specjalna libela / Μετρητής κλίσης / Reglón de albañil / Biffa da muratore / Remendo de pintura / Latte de maçons / Metselaarssabel

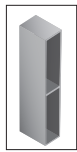
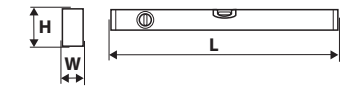

Ref.	L [cm]	H [mm]	W [mm]	☒	EAN
29C112	150	100	17	0/10	5902062870155
29C113	200	100	17	0/10	5902062870209
29C114	250	100	17	0/10	5902062870254
29C115	300	100	17	0/10	5902062870308

ŁATA MURARSKA

Traversing rule / Richtscheit / Правило строительное / Рейки мулярські / Őlesléc / Dreptar (calapod) / Zednická lat' / Lata murárska / Zidarska letev / Liniuotė mūrininkui / Mūrnieka trapece / Joonlaud / Маслар / Specjalna libela / Specjalna libela / Μετρητής κλίσης / Reglón de albañil / Biffa da muratore / Remendo de pintura / Latte de maçons / Metselaarssabel

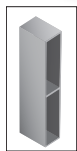
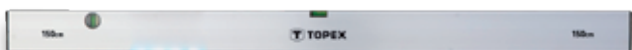
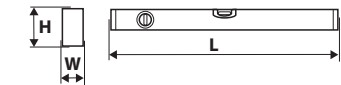

Ref.	L [cm]	H [mm]	W [mm]	☒	EAN
29C122	150	100	17	0/10	5902062872159
29C123	200	100	17	0/10	5902062872203
29C124	250	100	17	0/10	5902062872258
29C125	300	100	17	0/10	5902062872302

ŁATA MURARSKA

Traversing rule / Richtscheit / Правило строительное / Рейки мулярські / Őlesléc / Dreptar (calapod) / Zednická lat' / Lata murárska / Zidarska letev / Liniuotė mūrininkui / Mūrnieka trapece / Joonlaud / Маслар / Specjalna libela / Specjalna libela / Μετρητής κλίσης / Reglón de albañil / Biffa da muratore / Remendo de pintura / Latte de maçons / Metselaarssabel

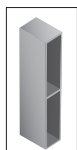
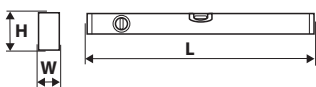

Ref.	L [cm]	H [mm]	W [mm]	☒	EAN
29C142	150	100	17	0/10	5902062874153
29C143	200	100	17	0/10	5902062874207
29C144	250	100	17	0/10	5902062874252
29C145	300	100	17	0/10	5902062874306

ŁATA TYNKARSKA

Trapezoid floating rule / Anschlaglatte / Правило штукатурное / Рейки тинькарські / Kardecsoni / Ráztaóare trapezoidálá / Strhovací lat' na omítku / Lata lichobežníková / Zidarska letev / Liniuotė tinkavimo darbamams / Арметēja trapece / Trapetsikujuline joonlaud / Маслар / Specjalna libela / Specjalna libela / Τραπεζοειδής μετρητής υποδιαστολής / Reglón de yesero / Biffa per intonaco / Remendo de estuque / Latte de plâtrage / Stukadoorsabel

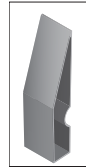
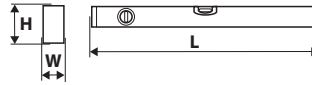

Ref.	L [cm]	H [mm]	W [mm]	☒	EAN
29C152	150	94	17	0/10	5902062875150
29C153	200	94	17	0/10	5902062875204
29C154	250	94	17	0/10	5902062875259
29C155	300	94	17	0/10	5902062875303

POZIOMNICA LASEROWA

Laser level / Laserwasserwaage / Лазерный прибор / Рівень лазерний / Lézeres vízszintező / Nivelă cu laser / Laserová vodováha / Laserová vodováha / Laserska libela / Lazerinis lygio matuoklis / Lázera līmeņrādis / Laserlood / Лазерна лубела / Laserska libela / Laserska libela / Αλφάδι λέιζερ / Nivel láser / Linea di livello a laser / Nivel de laser / Nivelée à laser / Laser waterpas



Ref.	dokładność [mm/m]	zasięg [m]	m [kg]	☒	EAN
29C912	+/- 0,5	10	3,9	0/4	5902062112330

POZIOMNICA LASEROWA

Laser level / Laserwasserwaage / Лазерный прибор / Рівень лазерний / Lézeres vízszintező / Nivelă cu laser / Laserová vodováha / Laserová vodováha / Laserska libela / Lazerinis lygio matuoklis / Lázera līmeņrādis / Laserlood / Лазерна лубела / Laserska libela / Laserska libela / Αλφάδι λέιζερ / Nivel láser / Linea di livello a laser / Nivel de laser / Nivelée à laser / Laser waterpas

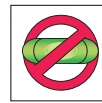
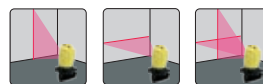

Ref.	dokładność [mm/m]	zasięg [m]	m [g]	☒	EAN
29C909	+/- 0,5	10	3,5	0/4	5902062299093

POZIOMNCA LASEROWA

Laser level / Laserwasserwaage / Лазерный прибор / Рівень лазерний / Lézeres vízszintező / Nivelă cu laser / Laserová vodováha / Laserová vodováha / Laserska libela / Lazerinis lygio matuoklis / Lāzera līmenrādītājs / Laserlood / Лазерна либела / Laserska libela / Laserska libela / Αλφάδι λέιζερ / Nivel láser / Linea di livello a laser / Nivel de laser / Nivelles à laser / Laser waterpas

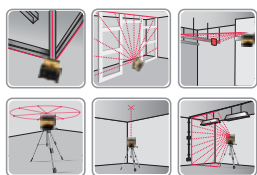

Ref.	dokładność [mm/m]	zasięg [m]	m [g]	☒	EAN
29C908	+/- 0,5	30	4,5	0/4	5902062299086

КАТОМИЕРЗ

Protractor / Winkelmesser / Угломер / Транспортир / Szögmérő / Echer réglabil / Úhloňmer / Uhlomer / Kotomer / Karpainis / Lerçktm̈ers / Nurgatm̈ödik / Ёгломер / Kutomjer / Uglomer / Μοιρογνωμόνιο / Escuadra / Goniometro / Transferidor regulável / Rapporteur / Gradenboog

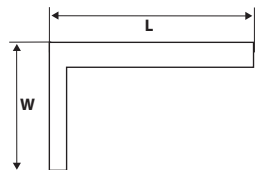

Ref.	L [mm]	W [mm]	☒	EAN
30C321	500	500	0/10	5902062111883

КАТОМИЕРЗ

Protractor / Winkelmesser / Угломер / Транспортир / Szögmérő / Echer réglabil / Úhloňmer / Uhlomer / Kotomer / Karpainis / Lerçktm̈ers / Nurgatm̈ödik / Ёгломер / Kutomjer / Uglomer / Μοιρογνωμόνιο / Escuadra / Goniometro / Transferidor regulável / Rapporteur / Gradenboog

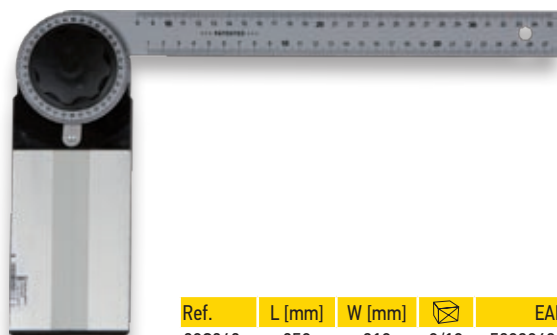
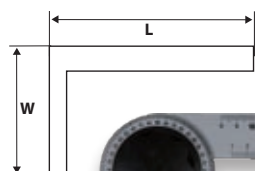

Ref.	L [mm]	W [mm]	☒	EAN
30C343	350	210	0/10	5902062111883
30C345	500	240	0/10	5902062111890
30C347	750	340	0/10	5902062111906

КАТОВНИК

Angle bar / Winkeleisen / Угольник / Косионец / Derékszög / Cornier / Úhelník / Uhlomer / Kotomer / Karpainis / Stürenis / Nurkraud / Ёзьльник / Kutnik / Uglomer / Μοιρογνωμόνιο / Escuadra / Profilato a L / Cantoneira / Cornière / Winkelhaak

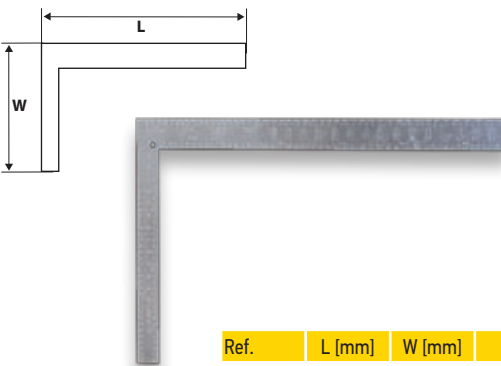

Ref.	L [mm]	W [mm]	☒	EAN
30C326	609	405	6/36	5902062303264

КАТОВНИК

Angle bar / Winkeleisen / Угольник / Косионец / Derékszög / Cornier / Úhelník / Uhlomer / Kotomer / Karpainis / Stürenis / Nurkraud / Ёзьльник / Kutnik / Uglomer / Μοιρογνωμόνιο / Escuadra / Profilato a L / Cantoneira / Cornière / Winkelhaak

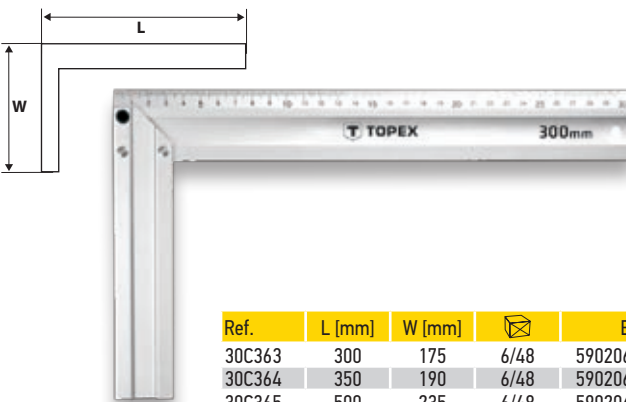

AL

Ref.	L [mm]	W [mm]	☒	EAN
30C363	300	175	6/48	5902062893635
30C364	350	190	6/48	5902062893642
30C365	500	235	6/48	5902062893659

PRZYMIAR LINIOWY

Steel rule / Lineal / Линејна / Лінійна стальна / Acélvonalzó / Metru de oțel / Měřidlo / Lineál ocelový / Ravnilo / Liniuotė / Lineāls / Terasjoonlaud / Линия / Ravnalo / Lenjir / Μετροταινία / Regla de medición / Riga lineare / Calibre para cordas / Réglet / Meetlat



Ref.	L [mm]	☒	EAN
30C217	750	10/50	5902062111180

PRZYMIAR LINIOWY

Steel rule / Lineal / Линејна / Лінійна стальна / Acélvonalzó / Metru de oțel / Měřidlo / Lineál ocelový / Ravnilo / Liniuotė / Lineāls / Terasjoonlaud / Линия / Ravnalo / Lenjir / Μετροταινία / Regla de medición / Riga lineare / Calibre para cordas / Réglet / Meetlat

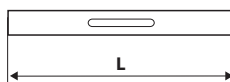

STAINLESS



Ref.	L [mm]	☒	EAN
31C030	300	12/300	5902062890306
31C050	500	12/120	5902062890504
31C075	750	12/120	5902062890610
31C100	1000	12/96	5902062890627

SZNUREK TRASERSKI

Chalk line / Trassierschnur / Шнур трассировочный / Шнур трасувальний / Kicsapózsínór / Linie bătută cu cretă / Trasovací šňůra / Snůrka značkovacia / Prah za označevanje / Virvė žymėjimai / Křída linija / Kriidlinõõr / Чертушка / Κοπας γραφεινσκι / Prah za obeleževanje / Σκοινί χάραξης / Cordón de trazar / Corda per tracciatura / Corda p. Traçar / Fil à tracer / Metselsnoer



Ref.	L [m]	☒	EAN
30C630	30	30/60	5902062306302

KREDA DO TRASOWANIA

Chalk / Trassierkreide / Мел трассировочный / Крейда трасувальна / Porfesték / Cretă / Křída / Farba / Kreda / Kreida žymėjimai / Křits křída linijai / Křit / Kreda za čertuška / Prah za crtanje / Prah za obeleževanje / Κυμλία για χάραξη / Polvo de trazado / Gesso per tracciatura / Giz p. traçar / Craie à tracer / Krijt



Ref.	m [g]	kolor	☒	EAN
30C616	115		10/100	5902062111869
30C617	115		10/100	5902062111876

PION MURARSKI

Plumb bob / Senklot / Отвес каменцка / Висок мулярський / Fügðövas / Pîrghie echilibrare / Olovnice / Olovnica / Svinčnica / Svambalas tūrininkui / Atsvars celtniecības / Nõõrlood / Omšec / Visak / Visak / Βαρίδι νηματος στάθμης / Plomada de albañil / Filo a piombo da muratore / Tubo vertical de construção / Fil à plomb de maçons / Schietlood

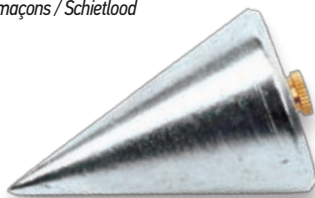

Ref.	m [g]	☒	EAN
30C643	275	6/48	5902062110923

MIARA SKŁADANA

Wooden rule / Zollstock / Лінейка складна / Лінійка складна, дерев'яна / Famerce / Metru pliant lemn / Skládací metr / Meter skladací / Zložljivi leseni meter / Medinis metras, sulankstomas / Metramērs saliekams / Kokkukäiv joonlaud / Метър / Drveni metar / Metar / Ξύλινο πτυσσόμενο μέτρο / Metro plegable de madera / Misura pieghevole / Medidor dobrável / Mesure articulée / Vouwmeter



Ref.	L [m]	kolor	☒	EAN
701	1		0/200	5902062111654
601	1		0/200	4005069012045
717	2		0/284	5902062111647
917	2		10/300	4005069016241
617	2		0/300	4005069011284

MIARA SKŁADANA

Wooden rule / Zollstock / Лінейка складна / Лінійка складна, дерев'яна / Famerce / Metru pliant lemn / Skládací metr / Meter skladací / Zložljivi leseni meter / Medinis metras, sulankstomas / Metramērs saliekams / Kokkukäiv joonlaud / Метър / Drveni metar / Metar / Ξύλινο πτυσσόμενο μέτρο / Metro plegable de madera / Misura pieghevole / Medidor dobrável / Mesure articulée / Vouwmeter



Ref.	L [m]	kolor	☒	EAN
26C001	1		0/200	5902062112026
26C021	2		0/284	5902062112040

MIARA SKŁADANA

Wooden rule / Zollstock / Лінейка складна / Лінійка складна, дерев'яна / Famerce / Metru pliant lemn / Skládací metr / Meter skladací / Zložljivi leseni meter / Medinis metras, sulankstomas / Metramērs saliekams / Kokkukäiv joonlaud / Метър / Drveni metar / Metar / Ξύλινο πτυσσόμενο μέτρο / Metro plegable de madera / Misura pieghevole / Medidor dobrável / Mesure articulée / Vouwmeter

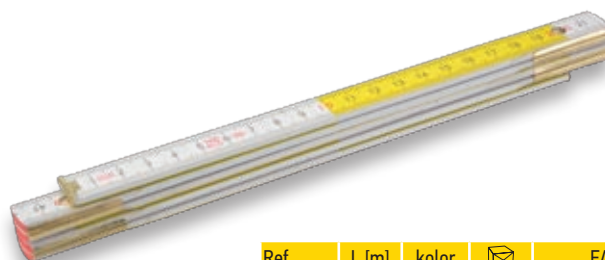

Ref.	L [m]	kolor	☒	EAN
26C005	1		0/200	5902062112422
26C006	2		0/284	5902062112439

SUWMIARKA

Caliper / Messschieber / Штангенциркуль / Штангенциркуль / Tolótmérő / Suport / Posuvné měřítko / Meradlo posuvné / Potično merilo / Slankmatis / Vidmērs / Mōātesirkel / Шублер / Potično mjerilo / Potično merilo / Αναλογικό παχύμετρο / Calibre / Calibro a cursore / Calibrador de correçã / Pied à coulisse / Schuifmaat

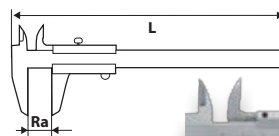

Ref.	L [mm]	Ra [mm]	dokt. [mm]	☒	EAN
31C615	230	0-150	0,05	10/40	5902062110435
31C616	230	0-200	0,05	5/50	5902062316165

SUWMIARKA

Caliper / Messschieber / Штангенциркуль / Штангенциркуль / Tolótmérő / Suport / Posuvné měřítko / Meradlo posuvné / Potično merilo / Slankmatis / Vidmērs / Mōātesirkel / Шублер / Potično mjerilo / Potično merilo / Αναλογικό παχύμετρο / Calibre / Calibro a cursore / Calibrador de correçã / Pied à coulisse / Schuifmaat

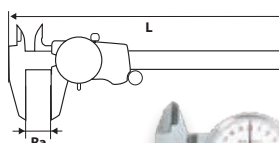

Ref.	L [mm]	Ra [mm]	dokt. [mm]	☒	EAN
31C627	230	0-150	0,02	0/30	5902062111296

SUWMIARKA

Caliper / Messschieber / Штангенциркуль / Штангенциркуль / Tolóméró / Suport / Posuvné měřítko / Meradlo posuvné / Pomíčno merilo / Slankmatis / Bīdmērs / Mōōtesirkel / Шублер / Pomíčno mjerilo / Pomíčno merilo / Αναλογικό παχύμετρο / Calibre / Calibro a cursore / Calibrador de corredeira / Pied à coulisse / Schuifmaat

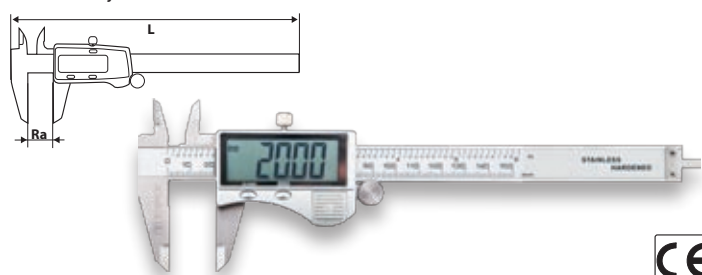

Ref.	L [mm]	Ra [mm]	dokt. [mm]	☒	EAN
31C624	230	0-150	0,02	0/40	5902062316240

SUWMIARKA

Caliper / Messschieber / Штангенциркуль / Штангенциркуль / Tolóméró / Suport / Posuvné měřítko / Meradlo posuvné / Pomíčno merilo / Slankmatis / Bīdmērs / Mōōtesirkel / Шублер / Pomíčno mjerilo / Pomíčno merilo / Αναλογικό παχύμετρο / Calibre / Calibro a cursore / Calibrador de corredeira / Pied à coulisse / Schuifmaat

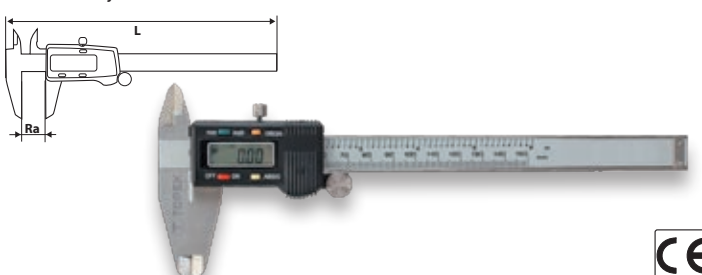

Ref.	L [mm]	Ra [mm]	dokt. [mm]	☒	EAN
31C628	235	0-150	0,02	0/50	5902062111302

SUWMIARKA

Caliper / Messschieber / Штангенциркуль / Штангенциркуль / Tolóméró / Suport / Posuvné měřítko / Meradlo posuvné / Pomíčno merilo / Slankmatis / Bīdmērs / Mōōtesirkel / Шублер / Pomíčno mjerilo / Pomíčno merilo / Αναλογικό παχύμετρο / Calibre / Calibro a cursore / Calibrador de corredeira / Pied à coulisse / Schuifmaat

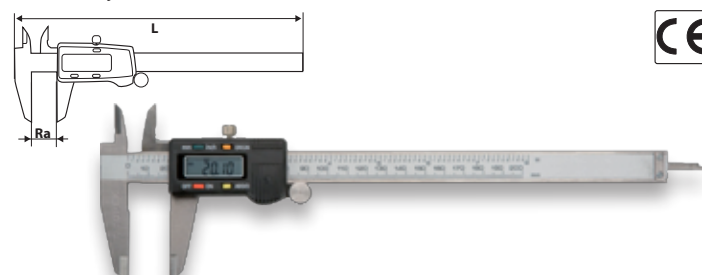

Ref.	L [mm]	Ra [mm]	dokt. [mm]	☒	EAN
31C625	290	0-200	0,02	0/50	5902062316257

MIKROMETR

Micrometer / Mikrometer / Микрометр / Микрометр / Microméter / Micrometru / Mikrometr / Mikrometer / Mikrometer / Mikrometras / Mikrometras / Mikromeeter / Микрометър / Mikrometar / Mikrometar / Μικρόμετρο / Micrómetro / Micrometro / Micrómetro / Micromètre / Micrometer

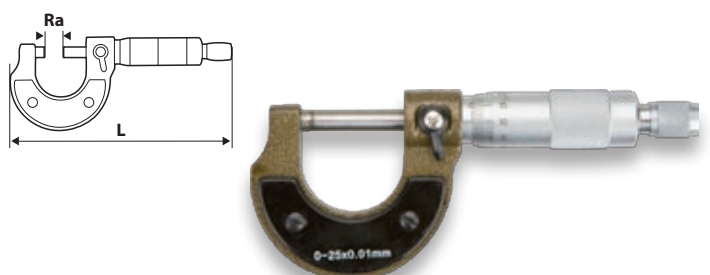

Ref.	L [mm]	Ra [mm]	dokt. [mm]	☒	EAN
31C629	135	0-25	0,01	0/50	5902062111319

RYSIK TRASERSKI

Scriber / Trassierstift / Штихель трассировочный / Штихель трасувальний / Rajztű / Daltű / Nádrh / Rysovací ihla / Pisalo / Brežiklis / Křída línija / Märknöel / Чертилка / Grift / Igla za obeležavanje / Εργαλείο χάραξης / Punta de trazar / Punta tracciante / Riscador para traçar / Pointe à tracer / Kraasnaald

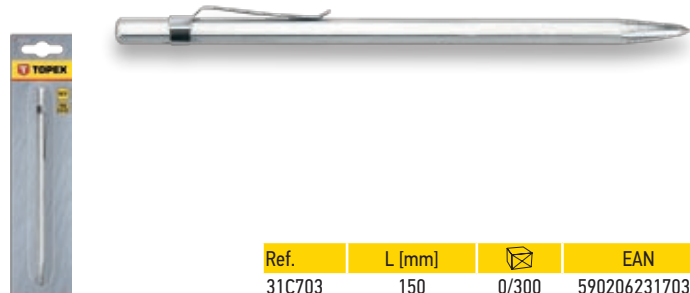
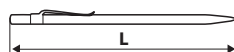

Ref.	L [mm]	☒	EAN
31C703	150	0/300	5902062317032

KAŹOMIERZ

Protractor / Winkelmesser / Угломер / Транспортир / Szögmérő / Echer réglabil / Úhloměr / Uhlomer / Kotomer / Kampainis / Lenkmērs / Νυργατόδίκ / Ёгломер / Kutomjer / Uglomer / Μοιρογνωμόνιο / Escuadra / Goniometro / Transferidor regulável / Rapporteur / Gradenboog

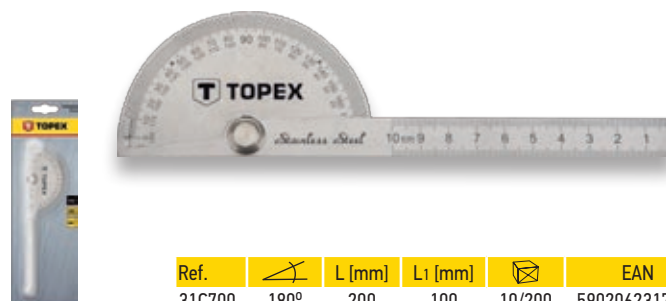
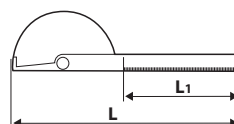

Ref.	∠	L [mm]	L1 [mm]	☒	EAN
31C700	180°	200	100	10/200	5902062317001

CYRKIEL ŚLUSARKI

Divider / Zirkel / Циркуль / Циркуль слюсарний / Lakatos körző / Compas pentru lăcătuș / Zámečnické kružítko / Zámečnické kružidlo / Šestilo / Skriestuvas šaltkalviui / Atslēdznieka cirkulis / Lukksepasirkel / Шлюпоческу нерзен / Bravarski šestar / Bravarski šestar / Διαβήτης / Compás de trazado / Compasso / Compasso p. serrallaria / Compas de serrurier / Steekpasser

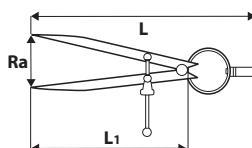

Ref.	L [mm]	L1 [mm]	Ra [mm]	∠	☒	EAN
31C701	210	150	0-160	65°	10/100	5902062317018

DROGOMIERZ

Measuring wheel / Wegstreckemesser / Мерное дорожное колесо / Одометр / Kerekes távolságmérő / Roată de măsurat distanțe reale / Trasoměr / Meracie koliesko / Merilno kolo / Kelio matuoklė / Ceļa mēritenis / Lābisoidumōdīk / Одометър / Ciklometar / Putomer / Τροχός μέτρησης αποστάσεων / Odómetro / Odometro / Roda de medição / Odometre (roue de mesure) / Meetwiel



Ref.	Ra [m]	dokt. [%]	☒	EAN
31C800	0,1 - 9999	0,5	0/4	5902062318008

ODLEGŁOŚCIOMIERZ

Distancer / Entfernungsmesser / Дальномер / Даленомір / Ultrahangos távolságmérő / Telemetru / Dálkoměr / Dialkomer ultrazvukový / Merilec oddaljenosti / Nuotolio matuoklis / Attāluma mēritājs / Mōōdik / Даленомер / Distancer / Daljinomer / Μετρητής αποστάσεων / Medidor ultrasonidos / Distanziometro / Medidor de distância / Télémètre / Afstandsmeter

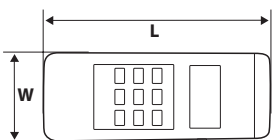

Ref.	L [mm]	W [mm]	Ra [m]	dokt. [%]	☒	EAN
31C901	148	58	0,55 - 12	0,5	0/50	5902062319012

ODLEGŁOŚCIOMIERZ

Distancer / Entfernungsmesser / Дальномер / Даленомір / Ultrahangos távolságmérő / Telemetru / Dálkoměr / Dialkomer ultrazvukový / Merilec oddaljenosti / Nuotolio matuoklis / Attāluma mēritājs / Mōōdik / Даленомер / Distancer / Daljinomer / Μετρητής αποστάσεων / Medidor ultrasonidos / Distanziometro / Medidor de distância / Télémètre / Afstandsmeter

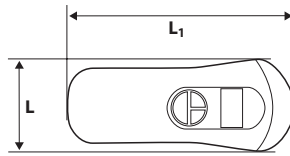

Ref.	L [mm]	W [mm]	Ra [m]	dokt. [%]	☒	EAN
31C902	127	55	0,4 - 18	0,5	0/50	5902062319029

MIERNIK ELEKTRONICZNY

Universal multimeter / Elektronikmessgerät / Мультиметр цифровой / Тестер универсальный / Multiméter / Multimétru universal / Elektronický měřicí přístroj / Univerzálny multiméter / Elektronski multiméter / Universalus el. matuoklis / Multimétrs universāls / Universaalne multimeeter / Μυλτιμετρ / Univerzalni multimetar / Umiverzalni multimetar / Ηλεκτρονικός μετρητής γενικής χρήσης / Multimetro digital / Misuratore elettronico / Medidor eletrônico / Appareil de mesure électronique / Elektronisch meter



Ref.	☒	EAN
94W101	0/50	5902062941015

MIERNIK ELEKTRONICZNY

Universal multimeter / Elektronikmessgerät / Мультиметр цифровой / Тестер универсальный / Multiméter / Multimétru universal / Elektronický měřicí přístroj / Univerzálny multiméter / Elektronski multiméter / Universalus el. matuoklis / Multimétrs universāls / Universaalne multimeeter / Μυλτιμετρ / Univerzalni multimetar / Umiverzalni multimetar / Ηλεκτρονικός μετρητής γενικής χρήσης / Multimetro digital / Misuratore elettronico / Medidor eletrônico / Appareil de mesure électronique / Elektronisch meter



Ref.	☒	EAN
94W102	0/30	5902062941022



Motoryzacyjne
Automotive
Автомоторный



TOPEX

PODNOŚNIK WARSZTATOWY

Shop crane / Werkstattheber / Внутрицеховой кран / Кран гаражний / Műhelydaru / Cric de atelier / Dilenský zvedák / Dielenský zdvihák / Dvigalka / Keltuvus dirbtuvėms / Profesionālais pacēlājs / Τοόκοjαtungraud / Ποδoυzαч / Radionička dizalica / Radionička dizalica / Γερανός για γκαράζ / Gato de taller / Cric da oficina / Elevador de oficina / Vérin d'atelier / Werkplaats hijstoestel

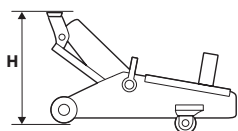

2t



Ref.	H _{min} [mm]	H _{max} [mm]	☐ [kg]	☒	EAN
97X004	130	345	9,5	0/1	5902062170019

PODNOŚNIK WARSZTATOWY

Shop crane / Werkstattheber / Внутрицеховой кран / Кран гаражний / Műhelydaru / Cric de atelier / Dilenský zvedák / Dielenský zdvihák / Dvigalka / Keltuvus dirbtuvėms / Profesionālais pacēlājs / Τοόκοjαtungraud / Ποδoυzαч / Radionička dizalica / Radionička dizalica / Γερανός για γκαράζ / Gato de taller / Cric da oficina / Elevador de oficina / Vérin d'atelier / Werkplaats hijstoestel

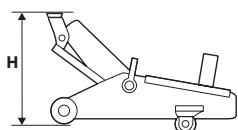

2t

Quick Lift



Ref.	H _{min} [mm]	H _{max} [mm]	☐ [kg]	☒	EAN
97X009	135	380	13,5	0/1	5902062970091

PODNOŚNIK WARSZTATOWY

Shop crane / Werkstattheber / Внутрицеховой кран / Кран гаражний / Műhelydaru / Cric de atelier / Dilenský zvedák / Dielenský zdvihák / Dvigalka / Keltuvus dirbtuvėms / Profesionālais pacēlājs / Τοόκοjαtungraud / Ποδoυzαч / Radionička dizalica / Radionička dizalica / Γερανός για γκαράζ / Gato de taller / Cric da oficina / Elevador de oficina / Vérin d'atelier / Werkplaats hijstoestel

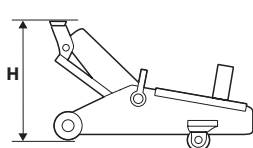

2,5t



Ref.	H _{min} [mm]	H _{max} [mm]	☐ [kg]	☒	EAN
97X025	120	483	33	0/1	5902062970251

PODNOŚNIK WARSZTATOWY

Shop crane / Werkstattheber / Внутрицеховой кран / Кран гаражний / Műhelydaru / Cric de atelier / Dilenský zvedák / Dielenský zdvihák / Dvigalka / Keltuvus dirbtuvėms / Profesionālais pacēlājs / Τοόκοjαtungraud / Ποδoυzαч / Radionička dizalica / Radionička dizalica / Γερανός για γκαράζ / Gato de taller / Cric da oficina / Elevador de oficina / Vérin d'atelier / Werkplaats hijstoestel

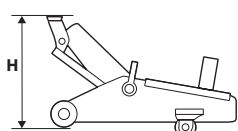

3t



Ref.	H _{min} [mm]	H _{max} [mm]	☐ [kg]	☒	EAN
97X030	145	520	39	0/1	5902062970305

PODNOŚNIK SŁUPKOWY

Bottle jack / Pfostenheber / Домкрат гидравлический "столбик" / Домкрат вертикальный / Olatajemelő / Cric cu șurub / Sloupkový zvedák / Zdvihák hydraulický stĺpkový / Hidraulicna dvigalka / Domkratas / Pacēlājs / Pudeltungraud / Крyк / Hidraulicna auto dizalica / Hidraulicna auto dizalica / Υδραυλικός γρύλος / Gato hidráulico de botella / Sollevatore con pilastro / Elevador vertical / Ascenseur à poteaux / Paalhijstoestel

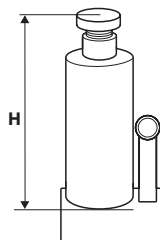

Ref.	F _{max} [t]	H _{max} [mm]	☐ [kg]	☒	EAN
97X032	2	181+164	2,5	0/6	5902062170026
97X033	3	194+177	2,2	0/6	5902062170033
97X035	5	216+230	4,3	1/4	5902062170040
97X040	10	230+230	6,2	0/4	5902062170057
97X042	15	230+230	8,5	0/1	5902062970428
97X043	20	242+210	10,0	0/1	5902062970435

PODSTAWKI POD SAMOCHÓD

Jack stands / Kfz-Untertagen / Подставки автомобильные / Підставка під автомобіль / Emelőbak / suport de ridicare / Podpěra ranenka / Podpera ranenka / Podstavki za hidraulicno dvigalko / Automobilinis domkratas / Paliktinis zem auto / Tungraua alused / Стойка за кола / Držač za auto dizalicu / Drzac za auto dizalicu / Γρύλος σταθερός / Soporte para coche / Sollevatori per autovettura / Soporte para carro / Supports pour voiture / Autosteunen

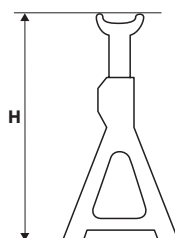

x2

Ref.	F _{max} [t]	H _{max} [mm]	☐ [kg]	☒	EAN
97X054	6	395+630	15,9	0/1	5902062970541

ROZPIERAKI

Long ram jacks / Spreizelemente / Распорки / Rozpiřky / Feszítők / Contrafișe / Rozpinače / Roztáhovacie / Rázpírak / Pleštuvai / Spraišļi / Nukkvällid / Εκτεμηριουμ / Distanceri / Cilindri / Εμβολοφόροι γρύλοι / Gatos / Divaricatori / Extensores / Ecarteurs / Heilbrekers



Ref.	F _{max} [t]	min dt. rozpięranka [mm]	max wysunięcia tłoka [mm]	☐ [kg]	☒	EAN
97X064	4	330	125	17	0/1	5902062970640
97X066	10	470	150	31	0/1	5902062970664

POMPA ROZPIERAKA

Pump for long ram jack / Pumpe zum Entfernen festsitzender Stellen / Насос для распорок / Помпа розпирка / Hidraulikus szivattyú fészítőhöz / Pompa expandorului / Čerpadlo rozpírače / Čerpadlo rozťahovača / Črpalka za razpiralo / Pleštuna pompa / Spraišlu sūkņis / Rehvīrump / Помпа на ексцентрика / Pompa za distancer / Pompa bregaste osovine / Άντλία εμβολοφόρου γυάλου / Bomba de gato / Pompa del divaricatore / Bomba / Pompe d'écarteur / Pomp voor heilbreker



10t

Ref.	☒ [kg]	☒	EAN
97X105	7,0	0/1	5902062971050

WYCIĄGARKA LINOWA

Cable puller / Seilwinde / Лебедка канатная / Лебідка тросова / Racsnis huzató / Dispozitiv pentru întinderea cablului / Lanový vrátek / Naviják lanový / Vlečna jeklena vrv / Keltuvus / Trošu vinča / Kaablitõmmits / Лебедка / Sajla / Sajla / Βαρούλκο ορεινού / Cabria de cable / Argano a fune / Guincho de corda / Treuil à levier à câble / Lijntakel



max 2,5
L
mm



Ref.	Fmax [t]	☒ [kg]	☒	EAN
97X080	2	3,1	0/6	5902062200211
97X082	3,5	5,9	0/2	5902062970824

WYCIĄGARKA LINOWA

Cable puller / Seilwinde / Лебедка канатная / Лебідка тросова / Racsnis huzató / Dispozitiv pentru întinderea cablului / Lanový vrátek / Naviják lanový / Vlečna jeklena vrv / Keltuvus / Trošu vinča / Kaablitõmmits / Лебедка / Sajla / Sajla / Βαρούλκο ορεινού / Cabria de cable / Argano a fune / Guincho de corda / Treuil à levier à câble / Lijntakel

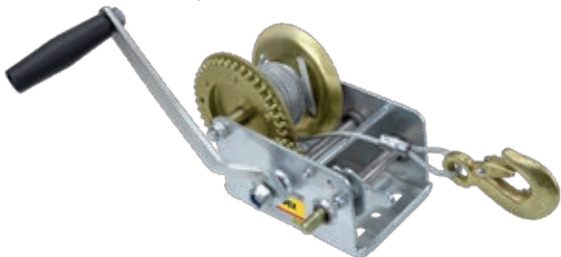

Ref.	Fmax [kg]	☒ [kg]	☒	EAN
97X085	540	3,75	1/6	5902062970855

WCIĄGARKA ŁAŃCUCHOWA

Chain block / Kettenwinde / Лебедка цепная / Таль ланцюгова / Láncos csőről / Trolu cu lant / Řetězový kladkostroj / Řetězový zdvihák / Verižna dvigalka / Grandininé gervé / Κέδες νιτσα / Kettvints / Вержна лебедка / Lančani podizač / Lančana dizalica / Βαρούλκο με αλυσίδα / Cabria de cadena / Argano a catena / Guindaste de corrente / Treuil à chaîne / Kettingtakel



max 2,5
L
mm



Ref.	Fmax [t]	☒ [kg]	☒	EAN
97X071	1,0	8,5	1/1	5902062970718
97X072	2,0	11,0	1/1	5902062970725

WCIĄGARKA ŁAŃCUCHOWA

Chain block / Kettenwinde / Лебедка цепная / Таль ланцюгова / Láncos csőről / Trolu cu lant / Řetězový kladkostroj / Řetězový zdvihák / Verižna dvigalka / Grandininé gervé / Κέδες νιτσα / Kettvints / Вержна лебедка / Lančani podizač / Lančana dizalica / Βαρούλκο με αλυσίδα / Cabria de cadena / Argano a catena / Guindaste de corrente / Treuil à chaîne / Kettingtakel



Ref.	Fmax [t]	☒ [kg]	☒	EAN
97X092	0,7	8	0/1	5902062970923
97X094	1,0	8	0/1	5902062970947
97X096	1,5	14	0/1	5902062970961

SZCZELINOMIERZ

Feeler gauge / Schiebelehre / Шlyn / Шlyn / Hézagmérő készlet / Calibru măsurare grosime / Spároměr / Listkové mierky / Kontrolní lističi / Ertmių matavimo prietaisai / Spraugmērs / Μόδτεσονδ / Лыфтомер / Kontrolni lističi / Kontrolni lističi / Διακενόμετρο / Calibre de espesores / Calibro a spessori / Medidor de folgas / Jauge d'épaisseur / Voelmaat



x20

Ref.	☒	EAN
97X272	0/1	5902062170590

KLUCZ DO ŚWIEC

Spark plug wrench / Zündkerzenschlüssel / Ключ свечной / Ключ для свічок / Gyertyakulcs / Cheie lumînare / Klíč na svíčky / Klíč sviečkový / Kľuč za vžigalno svečko / Raktas degimo žvakėms / Svečatslēga / Süütekiünla võti / Ключ за свещи / Kľuč za svijeće / Kľuc / Κλειδί για μπουζί / Llave para bujía / Chiave per candele / Chave p. velas / Clef à bougie / Kaarsleutel

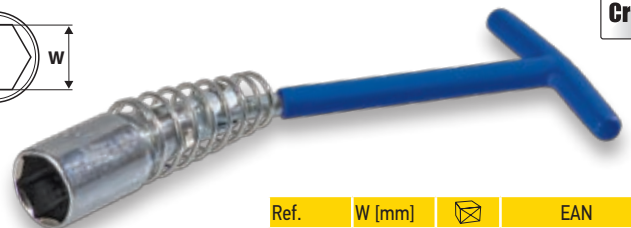

CrV

Ref.	W [mm]	☒	EAN
37D051	21	1/70	5902062370518
37D052	16	1/70	5902062370525

KLUCZ DO KÓŁ

Wheel wrench / Radschlüssel / Ключ для колес / Ключ для монтажу кіл автомобільних / Kerékkulcs / Cheie piuliță p/u demontarea și montarea roților / Klíč na kola / Kľuč na kolesá teleskopický / Kľuč za avtomobilska kolesa / Raktas ratams / Riteņu atslēga / Rattavõti / Ключ за гъми / Kľuč za kotač / Kľuc za točak / Κλειδί για τροχούς / Llave extensible para ruedas / Chiave per ruote / Chave para filtro / Clef pour filtre / Wielsleutel



Ref.	W [mm]	L1/L2	☒ [kg]	☒	EAN
37D305	17/19	340/520	1,1	0/24	5902062040671

KLUCZ DO KÓŁ

Wheel wrench / Radschlüssel / Ключ для колес / Ключ для монтажу кіл автомобільних / Kerékkulcs / Cheie piuliță p/u demontarea și montarea roților / Кліч на кола / Кліч на коlesá teleskopický / Кліюч за авtomobilска коlesа / Raktas ratams / Riteņu atslēga / Rattavõti / Ключ за зуми / Кліюч за kotač / Кліюч за točак / Кλειδί για τροχούς / Llave extensible para ruedas / Chiave per ruote / Chave para filtro / Clef pour filtre / Wielsleutel

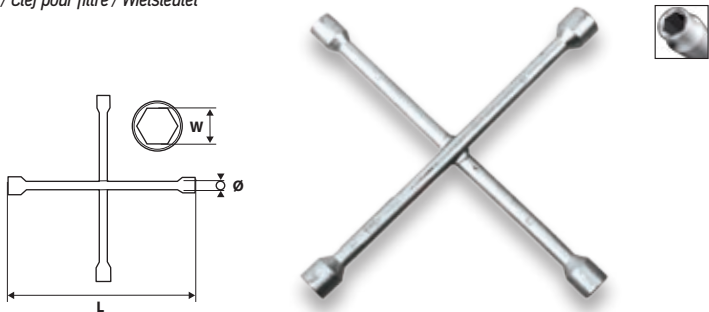

Ref.	W [mm]	Ø [mm]	L [mm]	kg [kg]	⊠	EAN
37D310	17, 19, 22, 13/16"	16	350	1,2	0/24	5902062040688

KLUCZ DO KÓŁ

Wheel wrench / Radschlüssel / Ключ для колес / Ключ для монтажу кіл автомобільних / Kerékkulcs / Cheie piuliță p/u demontarea și montarea roților / Кліч на кола / Кліч на коlesá teleskopický / Кліюч за авtomobilска коlesа / Raktas ratams / Riteņu atslēga / Rattavõti / Ключ за зуми / Кліюч за kotač / Кліюч за točак / Кλειδί για τροχούς / Llave extensible para ruedas / Chiave per ruote / Chave para filtro / Clef pour filtre / Wielsleutel

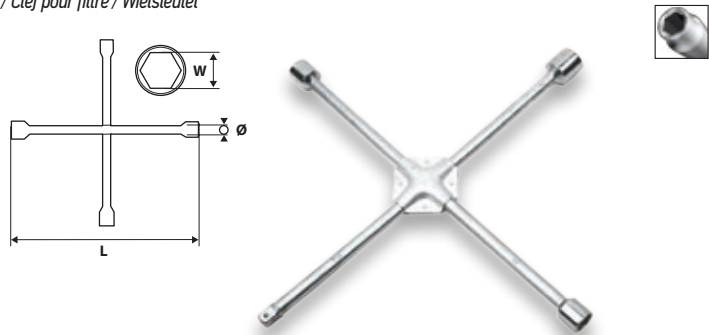

Ref.	W [mm]	Ø [mm]	L [mm]	kg [kg]	⊠	EAN
37D313	17, 19, 22, 1/2"	16	350	1,2	0/20	5902062040695

ŚCIĄGACZ DO ŁOŻYSK

Gear puller / Lagerabziehvorrichtung / Съемник подшипников / Пристрій для зняття підшипників / Csapágyelvező / Extractor elcoidal / Stahovák ložisek / Stahovák dvojramenný / Snemalec / Guolių nuėmiklis / Novilcējs gultņiem / Hammarratta tōmmits / Сьюба за лагери / Izvlakač / Radapciger / Κροκοπάλαγκο για άξονες τριβής / Extractor de cojinetes / Tenditore per cuscinetti / Ponta de aperto para rolamentos / Arrache-roulements / Lageronderbank

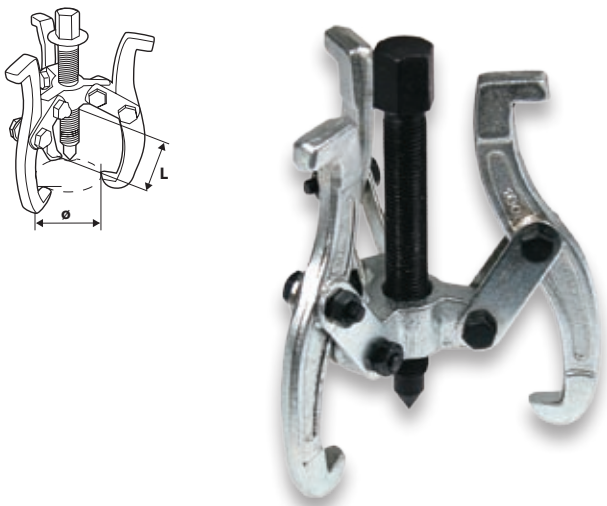

Ref.	Ø [mm]	L [mm]	kg [kg]	⊠	EAN
37D405	75	50	0,5	0/20	5902062040770
37D406	100	55	0,8	0/30	5902062040787

ŚCIĄGACZ DO PRZEGUBÓW

Joint puller / Abziehvorrichtung für Gelenke / Съемник шаровых опор / Знімач шарнірів / Gömbsuktoléhező / Dispozitiv de demontat articulații / Stahovák kloubů / Stahovák klbov / Izvlakač zglobov / Guolių nuėmimas / Gultņu nuilcējs / Tōmmits liigenditele / Сьюба за шарніру / Stezač za zglobove / Zglobna stega / Εξωλεκτάς / Extractor de juntas / Estrattore per giunti / Ponta de aperto para articulações / Extracteur pour articulations / Trekker voor spilverbindingen



Ref.	Ra [mm]	Ø [mm]	kg [kg]	⊠	EAN
37D410	45	15	1,0	0/10	5902062374103
37D415	45	15	0,4	10/50	5902062374158

MISKA MAGNETYCZNA

Magnetic tray / Magnetschüssel / Піддон магнітний / Піддон магнітний / Măgneses tálcă / Tava magnetica / Magnetická miska / Magnetická miska / Magnetna posoda / Magnetinis dubenėlis / Magnētiskais trauks / Magnetkauss / Магнітен харпер / Magnetna posuda / Magnetna činija / Μαγνητικός δίσκος / Plato magnético / Vaschetta magnetica / Tacho magnético / Récipient magnétique / Magnetische oprangbak



Ref.	Ø [mm]	info	⊠	EAN
37D899	150	plastic	1/48	5902062378996
37D900	150	stainless	1/48	5902062379009

KLUCZ DO FILTRA OLEJU

Key for oil filter / Schlüssel für Ölfilter / Съемник масляного фильтра / Ключ до оливного фільтру / Olajszűrő leszedő / Cheie pentru filtrul de ulei / Кліч на olejový filtr / Кліч на olejový filtr / Кліюч за олїни filter / Raktas tepalo filtrui / Atslēga eļļas filtram / Ölifiltri vōti / Водеща шина за араза / Кліюч за улїни filter / Кліюч за улјани filter / Кλειδί φίλτρου λαδιού / Llave para filtro de aceite / Chiave per il filtro dell'olio / Chave p. Filtras de óleo / Clef à filtre d'huile / Sleutel voor oliefilter



Ref.	Ø max [mm]	L [mm]	kg [kg]	⊠	EAN
37D204	110	150	0,5	0/10	5902062230379

KLUCZ DO FILTRA OLEJU

Key for oil filter / Schlüssel für Ölfilter / Съемник масляного фильтра / Ключ до оливного фільтру / Olajszűrő leszedő / Cheie pentru filtrul de ulei / Кліч на olejový filtr / Кліч на olejový filtr / Кліюч за олїни filter / Raktas tepalo filtrui / Atslēga eļļas filtram / Ölifiltri vōti / Водеща шина за араза / Кліюч за улїни filter / Кліюч за улјани filter / Кλειδί φίλτρου λαδιού / Llave para filtro de aceite / Chiave per il filtro dell'olio / Chave p. Filtras de óleo / Clef à filtre d'huile / Sleutel voor oliefilter



Ref.	Ø max [mm]	⊠	EAN
37D207	120	0/120	5902062230386