



**2013**



[www.yato.com](http://www.yato.com)

**1 SPANNERS / KLUCZE** 4-25

**2 SOCKETS, ACCESSORIES & SETS / KLUCZE NASADOWE, AKCESORIA I ZESTAWY** 26-69

**3 IMPACT SOCKETS, ACCESSORIES & SETS / UDAROWE KLUCZE NASADOWE, AKCESORIA I ZESTAWY** 70-79

**4 TORQUE WRENCHES & TORQUE MULTIPLIERS / KLUCZE DYNAMOMETRYCZNE I WZMACNIACZE MOMENTU** 80-85

**5 SCREWDRIVERS & SCREWDRIIVER BITS / WKREŃTAKI I KOŃCÓWKI WKREŃTAKOWE** 86-111

**6 PLIERS & PIPE WRENCHES / SZCZYPCE I KLUCZE DO RUR** 112-131

**7 ELECTRICIAN TOOLS / NARZĘDZIA DLA ELEKTRYKÓW** 132-143

**8 HAMMERS, CHISELS, PUNCHES & AXES / MŁOTKI, DŁUTA, PRZECINAKI I SIEKIERY** 144-153

**9 CLAMPS, VICES & HOLDERS / ŚCISKI, IMADŁA I WSPORNIKI** 154-159

**10 CUTTING TOOLS / NARZĘDZIA TNĄCE** 160-209

















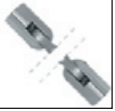

**11 HYDRAULIC TOOLS / NARZĘDZIA HYDRAULICZNE** 210-215

|    |   |         |
|----|---|---------|
| 12 | <b>FASTENING TOOLS / NARZĘDZIA DO ŁĄCZENIA</b>  | 216-227 |
| 13 | <b>CONSTRUCTION TOOLS / NARZĘDZIA BUDOWLANE</b>   | 228-243 |
| 14 | <b>MEASURING TOOLS / NARZĘDZIA MIERNICZE</b>  | 244-251 |
| 15 | <b>PNEUMATIC TOOLS / NARZĘDZIA PNEUMATYCZNE</b>   | 252-265 |
| 16 | <b>SPECIAL AUTOMOTIVE TOOLS &amp; EQUIPMENT / NARZĘDZIA I WYPOSAŻENIE WARSZTATU SAMOCHODOWEGO</b> | 266-331 |
| 17 | <b>POWER &amp; GASOLINE TOOLS / ELEKTRONARZĘDZIA I NARZĘDZIA SPALINOWE</b>                        | 332-339 |
| 18 | <b>PADLOCKS &amp; LOCK CYLINDERS / KLÓDKI I WKŁADKI DO ZAMKÓW</b>                                 | 340-343 |
| 19 | <b>ACCESSORIES / AKCESORIA</b>  | 344-347 |
| 20 | <b>HEALTH &amp; SAFETY ARTICLES / ARTYKUŁY BHP</b>  | 348-357 |
| 21 | <b>ELECTRIC PRODUCTS / ARTYKUŁY ELEKTRYCZNE</b>   | 358-363 |

# 1

## Spanners Klucze



|   |       |   |  |       |   |
|---|-------|---|--|-------|---|
| Combination spanners<br>Klucze płasko-oczkowe   | 6-9   |    | Reversible ratchet half-moon spanners<br>Klucze oczkowe typu „C” z grzechotką                | 19    |    |
| Combination spanners & sets, polished head<br>Klucze płasko-oczkowe i zestawy, polerowana główka                      | 6     |   | Flare nut wrenches & sets<br>Klucze oczkowe półotwarte i zestawy                             | 19    |    |
| Combination spanners & sets, satin finish<br>Klucze płasko-oczkowe i zestawy, wykończenie satynowe                    | 7     |   | Flexible flare nut wrenches & sets<br>Klucze oczkowe półotwarte z przegubem i zestawy        | 20    |    |
| Combination spanners S.A.E. & sets, polished head<br>Klucze płasko-oczkowe S.A.E. i zestawy, polerowana główka        | 8     |   | Torx ring spanner sets<br>Zestawy kluczy oczkowych „Torx”                                    | 20    |    |
| Stubby combination spanners, polished head<br>Klucze płasko-oczkowe krótkie, polerowana główka                        | 9     |   | L-type socket wrenches<br>Klucze nasadowe typu „L”   | 20    |    |
| Combination ratchet wrenches<br>Klucze płasko-oczkowe z grzechotką  | 9-11  |    | Open end swivel head socket wrenches & sets<br>Klucze płasko-nasadowe, przegubowe i zestawy  | 21    |    |
| Combination ratchet wrenches & sets<br>Klucze płasko-oczkowe z grzechotką i zestawy                                   | 9     |   | Double flexible socket wrenches & sets<br>Klucze nasadowe, przegubowe i zestawy              | 21    |  |
| Non-slip combination ratchet wrenches<br>Klucze płasko-oczkowe z grzechotką „Non-slip”                                | 10    |   | Tubular socket wrenches & accessories<br>Klucze rurowe kute i akcesoria                      | 22    |  |
| Rapid spline ratchet wrenches<br>Klucze „szybkie” z grzechotką „Spline”   | 11    |   | Double ratchet wrenches<br>Dwustronne klucze nasadowe z grzechotką                           | 22    |  |
| Flexible ratchet combination wrenches<br>Klucze płasko-oczkowe z grzechotką i przegubem                               | 11    |   | T-type & Y-type socket wrenches<br>Klucze nasadowe typu „T” i typu „Y”                       | 22-23 |  |
| Double open end spanners<br>Klucze płaskie  | 12-13 |    | Socket wrenches with handle<br>Klucze nasadowe z rękojeścią                                  | 22    |   |
| Double open end spanners & sets, polished head<br>Klucze płaskie i zestawy, polerowana główka                         | 12    |   | T-type deep socket wrenches with rotary handle<br>Klucze nasadowe typu „T” z obrotową rączką | 23    |   |
| Double open end spanners & sets, satin finish<br>Klucze płaskie i zestawy, wykończenie satynowe                       | 12    |   | T-type adapters with rotary handle<br>Adaptory typu „T” z obrotową rączką                    | 23    |   |
| Double open end spanners S.A.E. & sets, polished head<br>Klucze płaskie S.A.E. i zestawy, polerowana główka           | 13    |   | T-type deep socket wrenches<br>Klucze nasadowe typu „T”                                      | 23    |   |
| Double ratchet spanners & sets<br>Klucze oczkowe z grzechotką i zestawy   | 14    |  | Y-type socket wrenches<br>Klucze nasadowe typu „Y”   | 23    |   |
| Bi-hexagonal ring spanners<br>Klucze oczkowe odgięte  | 14-16 |  | Adjustable wrenches<br>Klucze nastawne   | 24    |  |
| Bi-hexagonal ring spanners & sets, polished head<br>Klucze oczkowe odgięte i zestawy, polerowana główka               | 14    |   | Adjustable wrenches<br>Klucze nastawne   | 24    |   |
| Bi-hexagonal ring spanners & sets, satin finish<br>Klucze oczkowe odgięte i zestawy, wykończenie satynowe             | 15    |   | Adjustable wrenches with composite handle<br>Klucze nastawne z rączką kompozytową            | 24    |   |
| Bi-hexagonal ring spanners S.A.E. & sets, polished head<br>Klucze oczkowe odgięte S.A.E. i zestawy, polerowana główka | 16    |   |  |       |   |
| Impact wrenches<br>Klucze do pobijania  | 17-18 |  |  |       |   |
| Ring impact wrenches<br>Klucze oczkowe do pobijania   | 17    |   |  |       |   |
| Open end impact wrenches<br>Klucze płaskie do pobijania   | 18    |   |  |       |   |
| Half-moon spanners<br>Klucze oczkowe typu „C”   | 19    |  |  |       |   |

GB Combination spanner  
D Maulringschlüssel  
PL Klucz płasko-oczkowy  
RUS Ключ комбинированный  
CZ Plochý a očkový klíč

H Kulcs villás-csillag  
RO Cheie combinată  
E Combinada con llave de estrella

DIN 3113 CrV AS-DRIVE

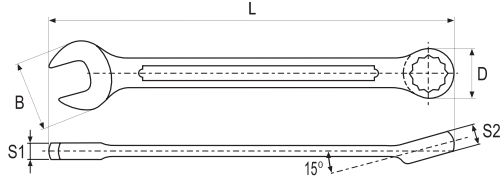

- application: workshop
- head offset: 15°
- surface finish: chromed, satin
- przeznaczenie: warsztat
- kąt odchylenia główki: 15°
- wykończenie powierzchni: chromowana, satynowa



| YATO    | Ø (mm) | L (mm) | B (mm) | D (mm) | S1 (mm) | S2 (mm) | PCS packing |         |
|---------|--------|--------|--------|--------|---------|---------|-------------|---------|
| YT-0335 | 6      | 110    | 14.8   | 10.5   | 3.7     | 4.9     | 10          | 300/600 |
| YT-0336 | 7      | 120    | 16.1   | 11.3   | 4.0     | 5.3     | 10          | 300/600 |
| YT-0337 | 8      | 130    | 18.5   | 12.9   | 4.2     | 5.0     | 10          | 180/360 |
| YT-0338 | 9      | 140    | 20.5   | 14.6   | 4.2     | 5.0     | 10          | 180/360 |
| YT-0339 | 10     | 150    | 22.2   | 16.2   | 4.9     | 6.4     | 10          | 180/360 |
| YT-0340 | 11     | 160    | 25.5   | 17.3   | 4.9     | 7.0     | 10          | 180/360 |
| YT-0341 | 12     | 170    | 26.7   | 18.7   | 5.3     | 7.6     | 10          | 120/240 |
| YT-0342 | 13     | 180    | 28.0   | 19.6   | 5.5     | 8.2     | 10          | 120/240 |
| YT-0343 | 14     | 190    | 30.3   | 21.4   | 5.9     | 7.7     | 10          | 50/100  |
| YT-0344 | 15     | 200    | 32.8   | 22.8   | 6.2     | 8.5     | 10          | 50/100  |
| YT-0345 | 16     | 210    | 33.9   | 23.7   | 6.1     | 9.1     | 10          | 50/100  |
| YT-0346 | 17     | 220    | 35.9   | 24.7   | 6.5     | 9.1     | 10          | 50/100  |
| YT-0347 | 18     | 230    | 37.8   | 26.9   | 6.9     | 10.0    | 10          | 50/100  |

| YATO    | Ø (mm) | L (mm) | B (mm) | D (mm) | S1 (mm) | S2 (mm) | PCS packing |        |
|---------|--------|--------|--------|--------|---------|---------|-------------|--------|
| YT-0348 | 19     | 235    | 38.9   | 27.7   | 7.0     | 10.1    | 10          | 50/100 |
| YT-0349 | 20     | 250    | 41.4   | 29.2   | 7.3     | 11.0    | 10          | 40/80  |
| YT-0350 | 21     | 260    | 43.4   | 31.0   | 7.1     | 10.9    | 10          | 40/80  |
| YT-0351 | 22     | 270    | 45.9   | 32.2   | 8.1     | 11.2    | 5           | 20/40  |
| YT-0352 | 23     | 280    | 47.8   | 34.3   | 7.8     | 11.1    | 5           | 20/40  |
| YT-0353 | 24     | 290    | 49.9   | 34.8   | 9.2     | 11.2    | 5           | 20/40  |
| YT-0354 | 25     | 300    | 51.2   | 36.6   | 9.2     | 12.4    | 5           | 20/40  |
| YT-0355 | 26     | 310    | 53.2   | 37.4   | 9.2     | 12.9    | 5           | 20/40  |
| YT-0356 | 27     | 320    | 55.9   | 39.3   | 9.3     | 12.7    | 5           | 15/30  |
| YT-0357 | 28     | 330    | 56.5   | 40.9   | 9.9     | 13.5    | 5           | 15/30  |
| YT-0358 | 29     | 340    | 60.0   | 42.4   | 10.0    | 13.6    | 5           | 15/30  |
| YT-0359 | 30     | 350    | 60.9   | 43.8   | 10.0    | 14.7    | 5           | 10/20  |
| YT-0360 | 32     | 370    | 64.5   | 46.6   | 11.3    | 14.9    | 5           | 10/20  |

GB Combination spanner  
D Maulringschlüssel  
PL Klucz płasko-oczkowy  
RUS Ключ комбинированный  
CZ Plochý a očkový klíč

H Kulcs villás-csillag  
RO Cheie combinată  
E Combinada con llave de estrella

AS-DRIVE

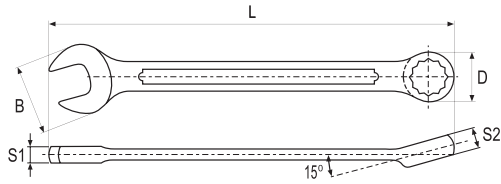

- application: workshop
- head offset: 15°
- surface finish: chromed, satin
- przeznaczenie: warsztat
- kąt odchylenia główki: 15°
- wykończenie powierzchni: chromowana, satynowa



| YATO     | Ø (mm) | L (mm) | B (mm) | D (mm) | S1 (mm) | S2 (mm) | PCS packing |    |
|----------|--------|--------|--------|--------|---------|---------|-------------|----|
| YT-00760 | 34     | 425    | 65.2   | 51.0   | 13.0    | 16.0    | 5           | 20 |
| YT-00761 | 36     | 460    | 73.0   | 57.0   | 14.0    | 17.5    | 5           | 15 |
| YT-00762 | 38     | 460    | 73.0   | 57.0   | 14.0    | 17.5    | 5           | 15 |
| YT-00763 | 41     | 500    | 83.0   | 61.5   | 15.0    | 19.0    | 5           | 10 |
| YT-00764 | 46     | 540    | 88.3   | 69.0   | 16.5    | 21.0    | 5           | 10 |

| YATO     | Ø (mm) | L (mm) | B (mm) | D (mm) | S1 (mm) | S2 (mm) | PCS packing |    |
|----------|--------|--------|--------|--------|---------|---------|-------------|----|
| YT-00765 | 48     | 570    | 92.0   | 72.0   | 16.5    | 22.0    | 5           | 10 |
| YT-00766 | 50     | 598    | 96.0   | 74.0   | 18.0    | 23.5    | 2           | 8  |
| YT-00767 | 55     | 620    | 105.6  | 82.4   | 19.0    | 25.0    | 2           | 6  |
| YT-00768 | 60     | 660    | 115.2  | 89.8   | 21.0    | 27.0    | 2           | 6  |
| YT-00769 | 65     | 680    | 124.8  | 97.3   | 23.0    | 29.0    | 2           | 4  |

GB Combination spanner set  
D Maulringschlüsselsatz  
PL Komplet kluczy płasko-oczkowych  
RUS Набор ключей комбинированных  
CZ Souprava plochých a očkových klíčů

H Kulcskészlet, villás-csillag  
RO Set cheie combinate  
E Juego de combinadas con llave de estrella



DIN 3113 CrV AS-DRIVE



12 PCS 8, 9, 10, 11, 12, 13, 14, 15, 17, 19, 22, 24 mm

|      |         |   |
|------|---------|---|
| YATO | YT-0362 | 6 |
|------|---------|---|



17 PCS 8, 9, 10, 11, 12, 13, 14, 15, 16, 17, 18, 19, 22, 24, 27, 30, 32 mm

|      |         |   |
|------|---------|---|
| YATO | YT-0363 | 3 |
|------|---------|---|



25 PCS 6, 7, 8, 9, 10, 11, 12, 13, 14, 15, 16, 17, 18, 19, 20, 21, 22, 23, 24, 25, 26, 27, 28, 30, 32 mm

|      |         |   |
|------|---------|---|
| YATO | YT-0365 | 3 |
|------|---------|---|

- GB Combination spanner  
D Maulringschlüssel  
PL Klucz płasko-oczkowy  
RUS Ключ комбинированный  
CZ Plochy a očkový klič  
H Kulcs villás-csillog
- RO Cheie combinată  
E Combinada con llave de estrella

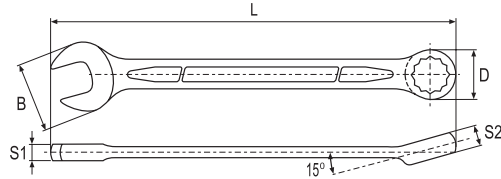

- application: industry
- head offset: 15°
- maximum torque exceeding DIN and ANSI standards by 60%
- surface finish: chromed, satin
- przeznaczenie: przemysł
- kąt odchylenia główki: 15°
- maksymalny moment obrotowy większy o 60% niż w standardach DIN i ANSI
- wykończenie powierzchni: chromowana, satynowa

\* - product not for european market  
\* - produkt nieprzeznaczony na rynek europejski



| YATO    | Ø (mm) | L (mm) | B (mm) | D (mm) | S1 (mm) | S2 (mm) | PCS packing: |     |
|---------|--------|--------|--------|--------|---------|---------|--------------|-----|
| YT-0006 | 6      | 109    | 14.4   | 10.3   | 3.7     | 5.2     | 10           | 600 |
| YT-0007 | 7      | 119    | 16.2   | 11.3   | 3.8     | 5.2     | 10           | 600 |
| YT-0008 | 8      | 129    | 18.6   | 12.8   | 4.2     | 5.7     | 10           | 360 |
| YT-0009 | 9      | 139    | 20.7   | 14.1   | 4.3     | 6.4     | 10           | 360 |
| YT-0010 | 10     | 149    | 22.6   | 15.2   | 4.8     | 6.9     | 10           | 360 |
| YT-0011 | 11     | 159    | 24.6   | 16.8   | 5.2     | 7.4     | 10           | 360 |
| YT-0012 | 12     | 169    | 27.1   | 18.0   | 5.3     | 7.9     | 10           | 240 |
| YT-0013 | 13     | 179    | 28.7   | 19.8   | 6.0     | 8.6     | 10           | 240 |
| YT-0014 | 14     | 189    | 31.3   | 20.8   | 6.2     | 8.9     | 10           | 100 |
| YT-0015 | 15     | 199    | 33.2   | 22.3   | 6.6     | 9.2     | 10           | 100 |
| YT-0016 | 16     | 209    | 35.0   | 23.8   | 6.8     | 9.9     | 10           | 100 |
| YT-0017 | 17     | 219    | 37.5   | 25.0   | 7.0     | 10.9    | 10           | 100 |
| YT-0018 | 18     | 229    | 39.5   | 26.6   | 7.8     | 11.4    | 10           | 100 |
| YT-0019 | 19     | 239    | 41.3   | 28.0   | 8.0     | 12.1    | 10           | 100 |
| YT-0020 | 20     | 249    | 44.1   | 29.8   | 8.3     | 12.4    | 10           | 80  |
| YT-0021 | 21     | 259    | 46.1   | 30.8   | 8.6     | 12.7    | 10           | 80  |

| YATO     | Ø (mm) | L (mm) | B (mm) | D (mm) | S1 (mm) | S2 (mm) | PCS packing: |      |
|----------|--------|--------|--------|--------|---------|---------|--------------|------|
| YT-0022  | 22     | 269    | 48.2   | 32.2   | 9.0     | 13.1    | 5            | 40   |
| YT-0023  | 23     | 279    | 49.8   | 33.6   | 9.2     | 13.4    | 5            | 40   |
| YT-0024  | 24     | 289    | 51.4   | 34.3   | 9.6     | 13.4    | 5            | 40   |
| YT-0025  | 25     | 299    | 54.6   | 36.8   | 9.8     | 14.2    | 5            | 40   |
| YT-0026  | 26     | 309    | 56.2   | 37.3   | 10.0    | 14.9    | 5            | 40   |
| YT-0027  | 27     | 319    | 58.7   | 39.6   | 10.4    | 16.4    | 5            | 30   |
| YT-0028  | 28     | 329    | 59.4   | 40.7   | 10.8    | 16.9    | 5            | 30   |
| YT-0029* | 29     | 339    | 60.9   | 41.7   | 11.0    | 17.4    | 5            | 30   |
| YT-0030  | 30     | 349    | 63.0   | 43.3   | 11.3    | 18.4    | 5            | 30   |
| YT-0032  | 32     | 369    | 67.3   | 44.8   | 11.8    | 19.4    | 4            | 24   |
| YT-0036  | 36     | 435    | 74.0   | 53.5   | 13.8    | 19.5    | -            | 5/10 |
| YT-0038  | 38     | 445    | 76.0   | 55.0   | 16.3    | 20.3    | -            | 5/10 |
| YT-0041  | 41     | 475    | 83.7   | 61.6   | 16.3    | 20.3    | -            | 2/8  |
| YT-0046  | 46     | 545    | 99.0   | 75.3   | 19.5    | 22.7    | -            | 2/8  |
| YT-0050  | 50     | 545    | 99.5   | 76.0   | 19.5    | 22.7    | -            | 2/8  |
| YT-0055  | 55     | 610    | 110.0  | 80.0   | 19.5    | 22.7    | -            | 2/4  |

- GB Combination spanner set  
D Maulringschlüsselsatz  
PL Komplet kluczy płasko-oczkowych
- RUS Набор ключей комбинированных  
CZ Souprava plochých a očkových kličů  
H Kulcskészlet, villás-csillog
- RO Set chei combinate  
E Juego de combinadas con llave de estrella



10 PCS  
6, 7, 8, 10, 12, 13, 14, 15, 17, 19 mm

YATO  
YT-0060 20



12 PCS  
8, 9, 10, 11, 12, 13, 14, 15, 17, 19, 22, 24 mm

YATO  
YT-0062 6



15 PCS  
6, 7, 8, 10, 11, 12, 13, 14, 15, 17, 18, 19, 22, 24, 27 mm

YATO  
YT-0065 8



17 PCS  
8, 9, 10, 11, 12, 13, 14, 15, 16, 17, 18, 19, 22, 24, 27, 30, 32 mm

YATO  
YT-0067 3



25 PCS  
6, 7, 8, 9, 10, 11, 12, 13, 14, 15, 16, 17, 18, 19, 20, 21, 22, 23, 24, 25, 26, 27, 28, 30, 32 mm

YATO  
YT-0075 3

GB Combination spanner  
D Maulringschlüssel  
PL Klucz płasko-oczkowy  
RUS Ключ комбинированный  
CZ Plochy a očkový klíč  
H Kulcs villás-csillog

RO Cheie combinată  
E Combinada con llave de estrella

COLOR BOX



DIN 3113 CrV 6140 AS-DRIVE



- application: industry
- head offset: 15°
- maximum torque exceeding DIN and ANSI standards by 60%
- surface finish: chromed, satin

- przeznaczenie: przemysł
- kąt odchylenia główki: 15°
- maksymalny moment obrotowy większy o 60% niż w standardach DIN i ANSI
- wykończenie powierzchni: chromowana, satynowa

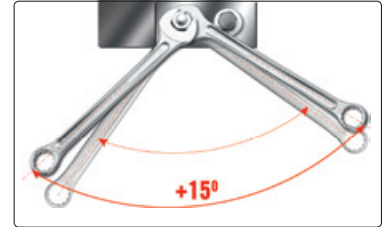
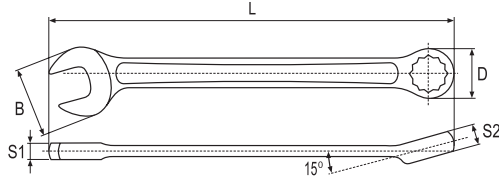

| YATO    | Ø (mm) | L (mm) | B (mm) | D (mm) | S1 (mm) | S2 (mm) | PCS packing: |     |
|---------|--------|--------|--------|--------|---------|---------|--------------|-----|
| YT-5000 | 6      | 105    | 14.6   | 10.6   | 3.3     | 6.5     | 10           | 600 |
| YT-5001 | 7      | 116    | 16.5   | 11.6   | 3.5     | 6.2     | 10           | 600 |
| YT-5002 | 8      | 125    | 18.4   | 13.0   | 4.0     | 6.9     | 10           | 360 |
| YT-5003 | 9      | 132    | 20.5   | 14.5   | 4.0     | 7.5     | 10           | 360 |
| YT-5004 | 10     | 144    | 22.1   | 15.4   | 4.2     | 7.8     | 10           | 360 |
| YT-5005 | 11     | 152    | 24.4   | 16.8   | 4.8     | 8.4     | 10           | 360 |
| YT-5006 | 12     | 160    | 26.1   | 18.3   | 4.9     | 8.4     | 10           | 240 |
| YT-5007 | 13     | 170    | 28.6   | 19.9   | 5.3     | 9.1     | 10           | 240 |
| YT-5008 | 14     | 180    | 30.6   | 20.9   | 5.3     | 9.7     | 10           | 100 |
| YT-5009 | 15     | 193    | 33.6   | 22.6   | 5.5     | 10.0    | 10           | 100 |
| YT-5010 | 16     | 200    | 34.4   | 24.5   | 6.0     | 10.8    | 10           | 100 |
| YT-5011 | 17     | 206    | 36.5   | 25.6   | 6.1     | 10.7    | 10           | 100 |
| YT-5012 | 18     | 215    | 38.8   | 26.5   | 6.8     | 11.6    | 10           | 100 |

| YATO    | Ø (mm) | L (mm) | B (mm) | D (mm) | S1 (mm) | S2 (mm) | PCS packing: |     |
|---------|--------|--------|--------|--------|---------|---------|--------------|-----|
| YT-5013 | 19     | 222    | 41.0   | 28.2   | 6.8     | 11.8    | 10           | 100 |
| YT-5014 | 20     | 237    | 43.4   | 30.1   | 7.0     | 12.5    | 10           | 80  |
| YT-5015 | 21     | 243    | 45.2   | 31.1   | 7.3     | 13.1    | 10           | 80  |
| YT-5016 | 22     | 255    | 46.8   | 32.4   | 7.4     | 13.7    | 5            | 40  |
| YT-5017 | 23     | 267    | 49.3   | 34.3   | 7.7     | 13.8    | 5            | 40  |
| YT-5018 | 24     | 271    | 50.5   | 36.1   | 8.2     | 14.4    | 5            | 40  |
| YT-5019 | 25     | 286    | 53.2   | 37.1   | 8.4     | 14.9    | 5            | 40  |
| YT-5020 | 26     | 295    | 54.5   | 38.7   | 8.7     | 15.2    | 5            | 40  |
| YT-5021 | 27     | 305    | 56.7   | 40.0   | 8.7     | 16.5    | 5            | 30  |
| YT-5022 | 28     | 315    | 58.7   | 41.6   | 9.5     | 16.8    | 5            | 30  |
| YT-5023 | 29     | 328    | 60.4   | 42.5   | 9.2     | 17.5    | 5            | 30  |
| YT-5024 | 30     | 340    | 62.4   | 44.7   | 10.4    | 18.7    | 5            | 30  |
| YT-5025 | 32     | 357    | 66.5   | 47.2   | 10.5    | 20.3    | 4            | 24  |

GB Combination spanner  
D Maulringschlüssel  
PL Klucz płasko-oczkowy  
RUS Ключ комбинированный  
CZ Plochy a očkový klíč  
H Kulcs villás-csillog

RO Cheie combinată  
E Combinada con llave de estrella

S.A.E. DIN 3113 CrV AS-DRIVE



- application: workshop
- head offset: 15°
- surface finish: chromed, satin / mirror

- przeznaczenie: warsztat
- kąt odchylenia główki: 15°
- wykończenie powierzchni: chromowana, satynowa / polerowana

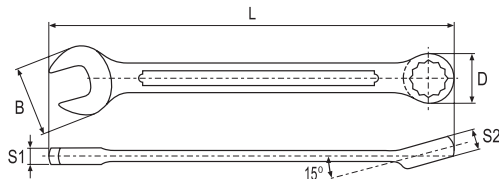

COLOR BOX



| YATO    | Ø                | L (mm) | B (mm) | D (mm) | S1 (mm) | S2 (mm) | PCS packing: |         |
|---------|------------------|--------|--------|--------|---------|---------|--------------|---------|
| YT-4870 | 1/4" (6.3 mm)    | 110    | 13.9   | 10.7   | 4.0     | 4.9     | 10           | 300/600 |
| YT-4871 | 5/16" (7.9 mm)   | 130    | 17.6   | 12.8   | 4.6     | 5.7     | 10           | 180/360 |
| YT-4872 | 3/8" (9.5 mm)    | 150    | 21.5   | 15.5   | 4.8     | 6.1     | 10           | 180/360 |
| YT-4873 | 7/16" (11.1 mm)  | 160    | 23.8   | 17.0   | 5.1     | 6.7     | 10           | 180/360 |
| YT-4874 | 1/2" (12.7 mm)   | 180    | 27.6   | 19.9   | 5.6     | 8.0     | 10           | 120/240 |
| YT-4875 | 9/16" (14.3 mm)  | 190    | 29.6   | 21.6   | 6.1     | 8.1     | 10           | 120/240 |
| YT-4876 | 5/8" (15.9 mm)   | 210    | 33.6   | 23.9   | 6.3     | 9.2     | 10           | 50/100  |
| YT-4877 | 11/16" (17.5 mm) | 230    | 37.8   | 26.3   | 6.7     | 10.8    | 10           | 50/100  |

| YATO    | Ø                 | L (mm) | B (mm) | D (mm) | S1 (mm) | S2 (mm) | PCS packing: |        |
|---------|-------------------|--------|--------|--------|---------|---------|--------------|--------|
| YT-4878 | 3/4" (19.0 mm)    | 240    | 40.1   | 27.9   | 7.2     | 10.6    | 10           | 50/100 |
| YT-4879 | 13/16" (20.6 mm)  | 260    | 43.2   | 31.1   | 7.6     | 10.8    | 10           | 40/80  |
| YT-4880 | 7/8" (22.2 mm)    | 270    | 46.5   | 32.9   | 8.4     | 11.6    | 5            | 20/40  |
| YT-4881 | 15/16" (23.8 mm)  | 290    | 50.2   | 34.9   | 8.7     | 12.0    | 5            | 20/40  |
| YT-4882 | 1" (25.4 mm)      | 300    | 51.9   | 36.2   | 8.8     | 12.7    | 5            | 20/40  |
| YT-4883 | 1-1/16" (27.0 mm) | 320    | 56.0   | 38.9   | 9.3     | 13.6    | 5            | 15/30  |
| YT-4884 | 1-1/8" (28.6 mm)  | 340    | 59.7   | 42.2   | 9.8     | 14.2    | 5            | 15/30  |
| YT-4885 | 1-1/4" (31.8 mm)  | 370    | 65.5   | 46.2   | 10.9    | 15.6    | 5            | 10/20  |

GB Combination spanner set  
D Maulringschlüsselsatz  
PL Komplet kluczy płasko-oczkowych  
RUS Набор ключей комбинированных  
CZ Souprava plochy a očkových klíčů  
H Kulcskészlet, villás-csillog  
RO Set chei combinate  
E Juego de combinadas con llave de estrella



POUCH



11 PCS S.A.E. DIN 3110 CrV AS-DRIVE

1/4" (6.3 mm), 5/16" (7.9 mm), 3/8" (9.5 mm),  
7/16" (11.1 mm), 1/2" (12.7 mm), 9/16" (14.3 mm),  
5/8" (15.9 mm), 11/16" (17.5 mm), 3/4" (19.0 mm),  
13/16" (20.6 mm), 7/8" (22.2 mm)

YATO  
YT-48851\* 10

\* - product not for european market  
\* - produkt nieprzeznaczony na rynek europejski



GB Stubby combination spanner  
D Maulringschlüssel  
PL Klucz płasko-oczkowy krótki  
RUS Ключ комбинированный  
CZ Plochý a očkový klíč  
H Kulcs villás-csillag  
RO Cheie combinată  
E Combinada con llave de estrella

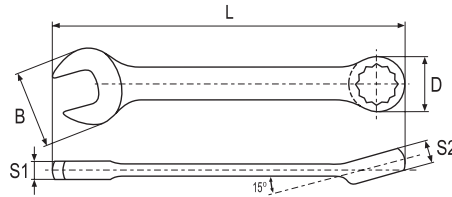

- application: workshop
- head offset: 15°
- surface finish: chromed
- przeznaczenie: warsztat
- kąt odchylenia główki: 15°
- wykończenie powierzchni: chromowana

| YATO    | Ø (mm) | L (mm) | B (mm) | D (mm) | S1 (mm) | S2 (mm) | PCS packing |         |
|---------|--------|--------|--------|--------|---------|---------|-------------|---------|
| YT-4901 | 8      | 91     | 19.2   | 13.9   | 5.0     | 6.3     | 10          | 120/240 |
| YT-4902 | 9      | 97     | 21.7   | 16.4   | 5.4     | 6.4     | 10          | 120/240 |
| YT-4903 | 10     | 97     | 21.9   | 16.6   | 5.2     | 6.4     | 10          | 120/240 |
| YT-4904 | 11     | 100    | 23.2   | 18.3   | 5.9     | 7.2     | 10          | 120/240 |
| YT-4905 | 12     | 108    | 27.4   | 20.2   | 6.4     | 7.6     | 10          | 120/240 |
| YT-4906 | 13     | 109    | 27.9   | 20.7   | 6.7     | 7.7     | 10          | 120/240 |

| YATO    | Ø (mm) | L (mm) | B (mm) | D (mm) | S1 (mm) | S2 (mm) | PCS packing |        |
|---------|--------|--------|--------|--------|---------|---------|-------------|--------|
| YT-4907 | 14     | 115    | 29.3   | 22.1   | 6.1     | 8.3     | 10          | 60/120 |
| YT-4908 | 15     | 120    | 31.2   | 24.0   | 6.8     | 9.6     | 10          | 60/120 |
| YT-4909 | 16     | 121    | 32.0   | 24.3   | 6.8     | 9.6     | 10          | 60/120 |
| YT-4910 | 17     | 128    | 36.6   | 27.1   | 7.4     | 9.9     | 10          | 60/120 |
| YT-4911 | 18     | 127    | 36.2   | 26.8   | 7.4     | 9.9     | 10          | 60/120 |
| YT-4912 | 19     | 135    | 39.2   | 29.5   | 8.8     | 10.8    | 10          | 60/120 |

COLOR BOX



CrV

AS-DRIVE

1

GB Combination ratchet wrench  
D Ratschenringmaulschlüssel  
PL Klucz płasko-oczkowy z grzechotką  
RUS Ключ комбинированный с трещоткой  
CZ Klíč očkoplochý ráčnový  
H Csillag-villás kulcs rácsnis  
RO Cheie combinată cu crichet  
E Llave combinada fija abierta y carraca

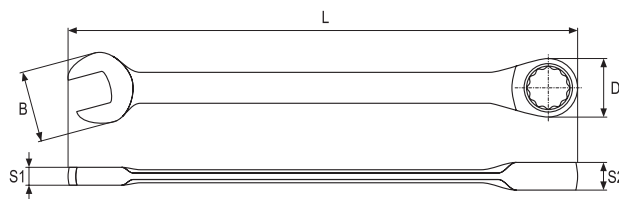

- application: service
- 72 teeth ratchet
- minimum operation angle: 5°
- surface finish: chromed, mirror
- przeznaczenie: serwis
- grzechotka 72 zęby
- minimalny kąt pracy: 5°
- wykończenie powierzchni: chromowana, polerowana



72T

CrV  
6140

AS-DRIVE

PLASTIC HANGER



PCS packing:

COLOR BOX



| YATO    | Ø (mm) | L (mm) | B (mm) | D (mm) | S1 (mm) | S2 (mm) | PCS packing |        |
|---------|--------|--------|--------|--------|---------|---------|-------------|--------|
| YT-0191 | 10     | 160    | 22.1   | 22.2   | 6.0     | 7.8     | 10          | 50/100 |
| YT-0192 | 11     | 165    | 24.7   | 24.2   | 6.6     | 8.5     | 10          | 50/100 |
| YT-0193 | 12     | 170    | 26.4   | 25.5   | 6.7     | 8.9     | 10          | 50/100 |
| YT-0194 | 13     | 180    | 27.5   | 26.7   | 6.6     | 9.2     | 10          | 50/100 |
| YT-0195 | 14     | 190    | 30.8   | 29.0   | 7.4     | 9.4     | 10          | 50/100 |
| YT-0196 | 15     | 200    | 32.9   | 30.8   | 7.7     | 10.1    | 10          | 50/100 |
| YT-0197 | 16     | 210    | 34.3   | 31.5   | 7.8     | 10.3    | 10          | 50/100 |
| YT-0198 | 17     | 225    | 36.8   | 33.6   | 8.4     | 10.6    | 10          | 50/100 |
| YT-0199 | 18     | 235    | 39.2   | 35.6   | 9.1     | 10.8    | 10          | 50/100 |

| YATO    | Ø (mm) | L (mm) | B (mm) | D (mm) | S1 (mm) | S2 (mm) | PCS packing |        |
|---------|--------|--------|--------|--------|---------|---------|-------------|--------|
| YT-0200 | 19     | 245    | 40.1   | 37.3   | 9.5     | 11.3    | 10          | 50/100 |
| YT-0189 | 21     | 290    | 45.2   | 43.0   | 9.9     | 13.3    | 6           | 30/60  |
| YT-0201 | 22     | 290    | 45.6   | 44.2   | 10.5    | 13.4    | 6           | 24/48  |
| YT-0202 | 24     | 335    | 52.8   | 50.0   | 11.3    | 14.5    | 6           | 48     |
| YT-0203 | 25     | 335    | 52.0   | 47.4   | 10.2    | 14.3    | 6           | 30     |
| YT-0204 | 27     | 355    | 55.6   | 52.7   | 10.9    | 15.7    | 6           | 30     |
| YT-0205 | 30     | 400    | 62.5   | 57.7   | 12.2    | 17.1    | 6           | 24     |
| YT-0206 | 32     | 420    | 65.0   | 61.7   | 13.2    | 17.9    | 6           | 24     |

GB Combination ratchet wrench set  
D Knarrenringmaulschlüssel-satz  
PL Komplet kluczy płasko-oczkowych z grzechotką  
RUS Набор комбинированных ключей с трещоткой  
CZ Klíče ráčnové sada  
H Rácsnis csillag-villás kulcs készlet  
RO Set chei combinate  
E Juego de llaves planas con matraca

7  
PCSCrV  
6140

72T



AS-DRIVE

10, 12, 13, 14, 15, 17, 19 mm

PLASTIC HANGER

YATO  
YT-0208PCS packing:  
10/20

- GB Combination ratchet wrench
- D Ratschenringmaulschlüssel
- PL Klucz płasko-oczkowy z grzechotką
- RUS Ключ комбинированный с трещоткой
- CZ Klíč očkoplochý ráčnový
- H Csillag-villás kulcs racsnis
- RO Cheie combinată cu crichet
- E Llave combinada  
fija abierta y carraca

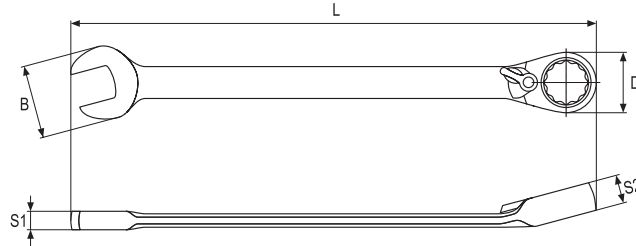
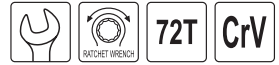

| YATO    | Ø (mm) | L (mm) | B (mm) | D (mm) | S1 (mm) | S2 (mm) | PCS packing: |        |
|---------|--------|--------|--------|--------|---------|---------|--------------|--------|
| YT-1651 | 8      | 140    | 17.5   | 19.0   | 6.0     | 7.2     | 10           | 50/100 |
| YT-1652 | 9      | 150    | 19.8   | 20.7   | 6.4     | 7.5     | 10           | 50/100 |
| YT-1653 | 10     | 160    | 22.1   | 23.1   | 6.4     | 7.9     | 10           | 50/100 |
| YT-1654 | 11     | 165    | 23.9   | 25.0   | 6.6     | 8.4     | 10           | 50/100 |
| YT-1655 | 12     | 170    | 27.1   | 26.0   | 6.5     | 8.9     | 10           | 50/100 |
| YT-1656 | 13     | 180    | 27.9   | 27.6   | 7.1     | 9.1     | 10           | 50/100 |
| YT-1657 | 14     | 190    | 31.6   | 28.3   | 7.3     | 9.5     | 10           | 50/100 |
| YT-1658 | 15     | 200    | 32.8   | 31.4   | 8.1     | 9.8     | 10           | 50/100 |
| YT-1659 | 16     | 210    | 33.9   | 32.9   | 8.4     | 10.3    | 10           | 50/100 |
| YT-1660 | 17     | 225    | 38.0   | 34.5   | 8.7     | 10.5    | 10           | 50/100 |
| YT-1661 | 18     | 235    | 39.8   | 36.9   | 9.3     | 10.7    | 10           | 50/100 |
| YT-1662 | 19     | 245    | 41.8   | 38.3   | 9.5     | 11.3    | 10           | 50/100 |

| YATO    | Ø (mm) | L (mm) | B (mm) | D (mm) | S1 (mm) | S2 (mm) | PCS packing: |       |
|---------|--------|--------|--------|--------|---------|---------|--------------|-------|
| YT-1663 | 20     | 245    | 41.9   | 38.1   | 9.7     | 11.4    | 6            | 30/60 |
| YT-1664 | 21     | 290    | 44.9   | 43.0   | 9.8     | 13.6    | 6            | 30/60 |
| YT-1665 | 22     | 290    | 44.8   | 43.8   | 10.0    | 13.6    | 6            | 30/60 |
| YT-1666 | 23     | 290    | 44.9   | 43.3   | 10.3    | 13.7    | 6            | 24/48 |
| YT-1667 | 24     | 330    | 52.0   | 49.4   | 10.2    | 14.5    | 6            | 24/48 |
| YT-1668 | 25     | 330    | 53.0   | 49.6   | 10.6    | 14.7    | 6            | 24/48 |
| YT-1669 | 26     | 360    | 56.3   | 53.6   | 12.1    | 15.7    | 6            | 30    |
| YT-1670 | 27     | 360    | 55.6   | 52.9   | 12.2    | 16.1    | 6            | 30    |
| YT-1671 | 28     | 360    | 56.1   | 53.6   | 12.6    | 16.0    | 6            | 24    |
| YT-1672 | 30     | 400    | 62.1   | 58.0   | 11.9    | 17.2    | 6            | 24    |
| YT-1673 | 32     | 420    | 64.1   | 62.0   | 12.9    | 17.7    | 6            | 24    |

- GB Combination ratchet wrench
- D Ratschenringmaulschlüssel
- PL Klucz płasko-oczkowy z grzechotką
- RUS Ключ комбинированный с трещоткой
- CZ Klíč očkoplochý ráčnový
- H Csillag-villás kulcs racsnis
- RO Cheie combinată cu crichet
- E Llave combinada  
fija abierta y carraca

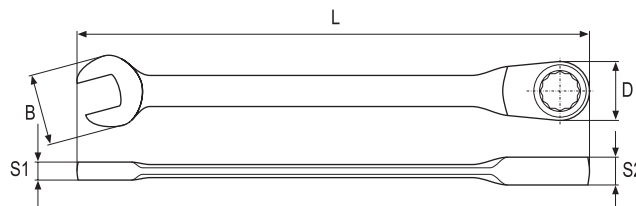

- application: industry
- 72 teeth ratchet
- minimum operation angle: 5°
- NON-SLIP system
- allows to unscrew 70% damaged hex screws
- surface finish: chromed, satin
- przeznaczenie: przemysł
- grzechotka 72 zęby
- minimalny kąt pracy: 5°
- system NON-SLIP
- umożliwia odkręcanie śrub sześciokątnych zniszczonych w 70%
- wykończenie powierzchni: chromowana, satynowa



| YATO    | Ø (mm) | L (mm) | B (mm) | D (mm) | S1 (mm) | S2 (mm) |        |
|---------|--------|--------|--------|--------|---------|---------|--------|
| YT-0255 | 10     | 157    | 22.0   | 21.3   | 5.6     | 8.5     | 10/100 |
| YT-0256 | 11     | 163    | 22.8   | 22.1   | 6.0     | 8.5     | 10/100 |
| YT-0257 | 12     | 171    | 25.1   | 23.3   | 6.5     | 8.5     | 10/100 |
| YT-0258 | 13     | 180    | 26.6   | 25.2   | 6.7     | 8.5     | 10/100 |
| YT-0259 | 14     | 188    | 29.7   | 26.5   | 7.3     | 8.5     | 10/100 |

| YATO    | Ø (mm) | L (mm) | B (mm) | D (mm) | S1 (mm) | S2 (mm) |        |
|---------|--------|--------|--------|--------|---------|---------|--------|
| YT-0260 | 15     | 201    | 31.6   | 28.4   | 7.4     | 8.5     | 10/100 |
| YT-0261 | 16     | 214    | 33.4   | 29.0   | 7.6     | 10.0    | 10/100 |
| YT-0262 | 17     | 229    | 36.8   | 30.2   | 7.9     | 10.0    | 10/100 |
| YT-0263 | 18     | 239    | 38.6   | 31.9   | 8.3     | 11.5    | 10/100 |
| YT-0264 | 19     | 250    | 39.0   | 33.6   | 8.7     | 11.5    | 10/100 |

GB Rapid combination ratchet wrench  
D Ratschenringmaulschlüssel  
PL Klucz „szybki” z grzechotką  
RUS Ключ комбинированный с трещоткой  
CZ Klič oškoplochý ráčnový  
H Csillag-villás kulcs racsnis  
RO Cheie combinata cu crichet  
E Llave combinada  
fija abierta y carraca

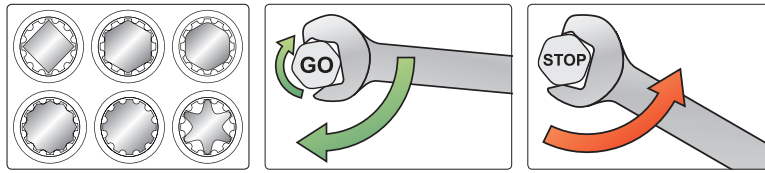

- application: industry
- 72 teeth ratchet
- minimum operation angle: 5°
- spline profile serves for 5 types of nuts
- surface finish: chromed, mirror
- przeznaczenie: przemysł
- grzechotka 72 zęby
- minimalny kąt pracy: 5°
- profil Spline – obsługuje 5 rodzajów nakrętek
- wykończenie powierzchni: chromowana, polerowana

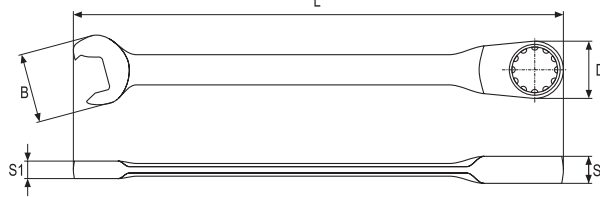

\* - product not for european market  
\* - produkt nieprzeznaczony na rynek europejski

PLASTIC HANGER

| YATO     | Ø (mm) | L (mm) | B (mm) | D (mm) | S1 (mm) | S2 (mm) | PCS    |
|----------|--------|--------|--------|--------|---------|---------|--------|
| YT-0155  | 8      | 144    | 15.35  | 17.70  | 4.96    | 7.28    | 10/100 |
| YT-0156  | 9      | 150    | 16.65  | 19.40  | 4.65    | 7.28    | 10/100 |
| YT-0157* | 10     | 158    | 18.70  | 21.00  | 5.08    | 8.20    | 10/100 |
| YT-0158  | 11     | 165    | 20.32  | 21.55  | 5.70    | 8.20    | 10/100 |
| YT-0159  | 12     | 173    | 22.47  | 23.24  | 6.00    | 8.20    | 10/100 |
| YT-0160  | 13     | 182    | 23.88  | 24.80  | 6.70    | 8.20    | 10/100 |

| YATO    | Ø (mm) | L (mm) | B (mm) | D (mm) | S1 (mm) | S2 (mm) | PCS    |
|---------|--------|--------|--------|--------|---------|---------|--------|
| YT-0161 | 14     | 190    | 26.60  | 25.90  | 6.70    | 8.20    | 10/100 |
| YT-0162 | 15     | 202    | 27.80  | 27.55  | 7.30    | 8.20    | 10/100 |
| YT-0163 | 16     | 215    | 30.20  | 28.55  | 7.55    | 9.92    | 10/100 |
| YT-0164 | 17     | 229    | 31.80  | 30.15  | 7.90    | 9.85    | 10/100 |
| YT-0165 | 19     | 252    | 35.45  | 34.00  | 8.65    | 11.50   | 10/100 |

GB Flexible ratchet combination wrench  
D Ratschenringmaulschlüssel  
PL Klucz płasko-oczkowy z grzechotką i przegubem  
RUS Ключ комбинированный с трещоткой  
CZ Klič oškoplochý ráčnový  
H Csillag-villás kulcs racsnis  
RO Cheie combinata cu crichet  
E Llave combinada fija abierta y carraca

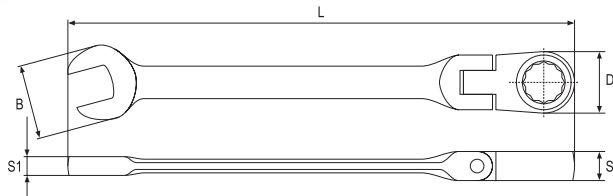

PLASTIC HANGER

PCS packing:



COLOR BOX

| YATO    | Ø (mm) | L (mm) | B (mm) | D (mm) | S1 (mm) | S2 (mm) | PCS packing: |
|---------|--------|--------|--------|--------|---------|---------|--------------|
| YT-1674 | 8      | 140    | 18.0   | 19.6   | 6.3     | 7.3     | 10 50/100    |
| YT-1675 | 9      | 145    | 19.7   | 21.1   | 4.7     | 7.6     | 10 50/100    |
| YT-1676 | 10     | 160    | 22.8   | 23.2   | 6.3     | 7.8     | 10 50/100    |
| YT-1677 | 11     | 160    | 24.0   | 24.7   | 5.4     | 8.5     | 10 50/100    |
| YT-1678 | 12     | 170    | 26.4   | 26.7   | 6.8     | 8.8     | 10 50/100    |
| YT-1679 | 13     | 180    | 28.4   | 27.3   | 7.2     | 9.1     | 10 50/100    |
| YT-1680 | 14     | 185    | 29.5   | 28.7   | 6.8     | 9.4     | 10 50/100    |
| YT-1681 | 15     | 195    | 32.9   | 30.8   | 7.2     | 9.8     | 10 50/100    |
| YT-1682 | 16     | 210    | 34.4   | 33.3   | 7.6     | 10.3    | 10 50/100    |
| YT-1683 | 17     | 230    | 36.7   | 35.7   | 8.3     | 10.5    | 10 50/100    |
| YT-1684 | 18     | 235    | 39.0   | 35.9   | 8.0     | 10.8    | 10 50/100    |
| YT-1685 | 19     | 245    | 40.8   | 37.6   | 9.5     | 11.2    | 10 50/100    |

| YATO    | Ø (mm) | L (mm) | B (mm) | D (mm) | S1 (mm) | S2 (mm) | PCS packing: |
|---------|--------|--------|--------|--------|---------|---------|--------------|
| YT-1686 | 20     | 245    | 40.9   | 38.2   | 8.8     | 11.1    | 6 30/60      |
| YT-1687 | 21     | 290    | 45.0   | 42.8   | 9.8     | 13.6    | 6 30/60      |
| YT-1688 | 22     | 290    | 45.2   | 42.7   | 9.8     | 13.5    | 6 30/60      |
| YT-1689 | 23     | 290    | 45.3   | 42.8   | 9.6     | 13.6    | 6 24/48      |
| YT-1690 | 24     | 330    | 51.3   | 48.7   | 10.4    | 14.5    | 6 24/48      |
| YT-1691 | 25     | 330    | 51.4   | 48.4   | 10.6    | 14.5    | 6 24/48      |
| YT-1692 | 26     | 360    | 56.6   | 53.6   | 11.6    | 15.7    | 6 30         |
| YT-1693 | 27     | 360    | 56.7   | 53.2   | 11.7    | 15.8    | 6 30         |
| YT-1694 | 28     | 360    | 56.4   | 53.5   | 11.0    | 15.8    | 6 24         |
| YT-1695 | 30     | 410    | 61.6   | 58.7   | 12.4    | 17.2    | 6 24         |
| YT-1696 | 32     | 430    | 64.7   | 63.3   | 12.8    | 17.8    | 6 24         |

GB Flexible ratchet combination wrench  
D Ratschenringmaulschlüssel  
PL Klucz płasko-oczkowy z grzechotką i przegubem  
RUS Ключ комбинированный с трещоткой  
CZ Klič oškoplochý ráčnový  
H Csillag-villás kulcs racsnis  
RO Cheie combinata cu crichet  
E Llave combinada fija abierta y carraca



- application: industry
- 72 teeth ratchet
- minimum operation angle: 5°
- articulated joint for ring head
- surface finish: chromed, mirror
- przeznaczenie: przemysł
- grzechotka 72 zęby
- minimalny kąt pracy: 5°
- przegub przy główce oczkowej
- wykończenie powierzchni: chromowana, polerowana

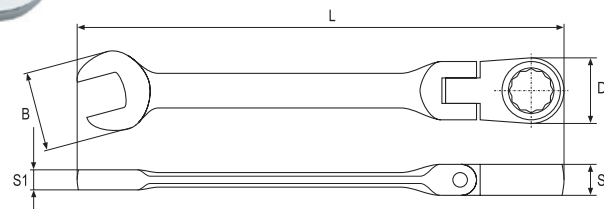

PLASTIC HANGER

| YATO    | Ø (mm) | L (mm) | B (mm) | D (mm) | S1 (mm) | S2 (mm) | PCS    |
|---------|--------|--------|--------|--------|---------|---------|--------|
| YT-0271 | 10     | 133    | 21.9   | 21.0   | 5.8     | 8.4     | 10/100 |
| YT-0272 | 11     | 139    | 22.8   | 22.0   | 6.0     | 8.4     | 10/100 |
| YT-0273 | 12     | 144    | 25.3   | 23.6   | 6.0     | 8.4     | 10/100 |
| YT-0274 | 13     | 152    | 27.1   | 24.9   | 6.6     | 8.4     | 10/100 |
| YT-0275 | 14     | 157    | 29.8   | 26.5   | 7.3     | 8.4     | 10/100 |

| YATO    | Ø (mm) | L (mm) | B (mm) | D (mm) | S1 (mm) | S2 (mm) | PCS    |
|---------|--------|--------|--------|--------|---------|---------|--------|
| YT-0276 | 15     | 167    | 31.6   | 27.7   | 7.4     | 8.4     | 10/100 |
| YT-0277 | 16     | 177    | 33.7   | 29.1   | 7.6     | 10.0    | 10/100 |
| YT-0278 | 17     | 187    | 37.0   | 30.5   | 8.0     | 10.0    | 10/100 |
| YT-0279 | 18     | 201    | 39.0   | 31.7   | 8.4     | 11.5    | 10/100 |
| YT-0280 | 19     | 213    | 39.7   | 34.2   | 8.5     | 11.5    | 10/100 |

- GB Double open end spanner
- D Doppelmaulschlüssel
- PL Klucz płaski
- RUS Ключ рожковый
- CZ Plochéy klíč
- H Villáskulcs
- RO Cheie fixă
- E Llave fija

DIN 3110 CrV

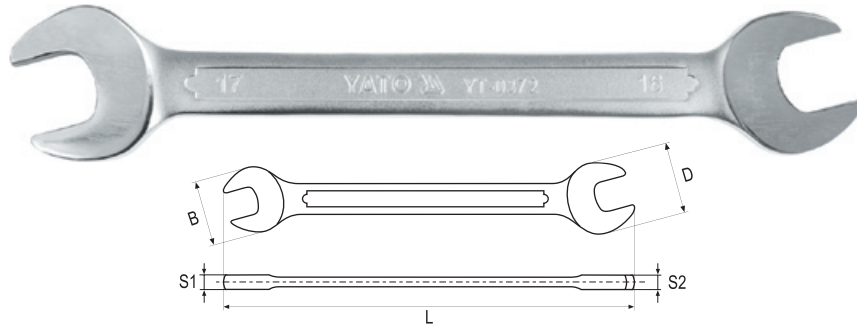

• surface finish:  
chromed, satin / mirror

• wykończenie powierzchni:  
chromowana, satynowa / polerowana

\* - product not for european market  
\* - produkt nieprzeznaczony na rynek europejski



COLOR BOX

| YATO     | Ø (mm) | L (mm) | B (mm) | D (mm) | S1 (mm) | S2 (mm) | PCS packing: |         |
|----------|--------|--------|--------|--------|---------|---------|--------------|---------|
| YT-4800* | 5.5x7  | 120    | 14.3   | 16.6   | 4.0     | 4.0     | 10           | 300/600 |
| YT-0367  | 6x7    | 120    | 15.1   | 16.8   | 3.5     | 3.6     | 10           | 360/720 |
| YT-0368  | 8x9    | 140    | 18.7   | 20.8   | 3.7     | 3.6     | 10           | 180/360 |
| YT-4801* | 8x10   | 140    | 18.1   | 20.6   | 4.5     | 4.5     | 10           | 150/300 |
| YT-4802* | 9x11   | 155    | 22.2   | 24.8   | 4.8     | 4.8     | 10           | 150/300 |
| YT-0369  | 10x11  | 155    | 22.4   | 25.5   | 4.6     | 4.6     | 10           | 150/300 |
| YT-4803* | 10x12  | 155    | 22.7   | 25.4   | 4.9     | 5.0     | 10           | 150/300 |
| YT-0332  | 10x13  | 170    | 22.5   | 29.3   | 4.6     | 5.3     | 10           | 150/300 |
| YT-4804* | 11x13  | 170    | 25.3   | 28.2   | 5.2     | 5.2     | 10           | 80/160  |
| YT-0370  | 12x13  | 170    | 27.1   | 29.3   | 4.9     | 5.3     | 10           | 80/160  |
| YT-4805* | 12x14  | 170    | 26.7   | 29.4   | 5.3     | 5.0     | 10           | 80/160  |
| YT-4806* | 13x15  | 185    | 31.2   | 33.4   | 6.0     | 5.9     | 10           | 80/160  |
| YT-4807* | 13x16  | 185    | 31.0   | 33.3   | 6.0     | 5.8     | 10           | 80/160  |
| YT-0333  | 13x17  | 180    | 29.3   | 37.5   | 5.3     | 6.3     | 10           | 50/100  |
| YT-0371  | 14x15  | 180    | 31.0   | 33.0   | 5.3     | 5.4     | 10           | 80/160  |
| YT-4808* | 14x17  | 190    | 28.9   | 37.0   | 5.7     | 5.7     | 10           | 50/100  |
| YT-0372  | 16x17  | 200    | 34.9   | 37.5   | 6.5     | 6.3     | 10           | 50/100  |

| YATO     | Ø (mm) | L (mm) | B (mm) | D (mm) | S1 (mm) | S2 (mm) | PCS packing: |        |
|----------|--------|--------|--------|--------|---------|---------|--------------|--------|
| YT-4809* | 16x18  | 200    | 34.6   | 37.4   | 6.2     | 6.1     | 10           | 50/100 |
| YT-0334  | 17x19  | 220    | 37.5   | 38.7   | 6.3     | 6.3     | 10           | 50/100 |
| YT-0373  | 18x19  | 220    | 38.7   | 41.0   | 6.6     | 6.3     | 10           | 50/100 |
| YT-4810* | 19x21  | 235    | 42.4   | 47.1   | 6.7     | 6.6     | 10           | 30/60  |
| YT-4811* | 19x22  | 235    | 42.5   | 47.2   | 6.6     | 6.6     | 10           | 30/60  |
| YT-0374  | 20x22  | 230    | 42.1   | 46.8   | 7.1     | 6.8     | 10           | 30/60  |
| YT-0375  | 21x23  | 245    | 44.4   | 48.6   | 7.3     | 6.9     | 10           | 30/60  |
| YT-4812* | 22x24  | 250    | 46.7   | 51.3   | 7.6     | 8.0     | 10           | 20/40  |
| YT-4813* | 23x26  | 260    | 51.9   | 56.6   | 8.4     | 8.3     | 5            | 20/40  |
| YT-0376  | 24x27  | 260    | 51.6   | 56.9   | 8.1     | 8.1     | 5            | 20/40  |
| YT-0377  | 25x28  | 270    | 52.3   | 57.9   | 8.4     | 8.3     | 5            | 20/40  |
| YT-4814* | 27x30  | 280    | 56.9   | 63.2   | 8.6     | 9.0     | 5            | 15/30  |
| YT-0378  | 30x32  | 295    | 61.4   | 65.1   | 8.0     | 8.6     | 5            | 15/30  |
| YT-4815* | 30x34  | 285    | 64.2   | 68.9   | 11.4    | 11.0    | 5            | 15/30  |
| YT-4816* | 32x34  | 285    | 63.7   | 68.6   | 11.3    | 11.0    | 5            | 10     |
| YT-4817* | 34x36  | 280    | 63.8   | 68.6   | 11.3    | 11.1    | 5            | 10     |

- GB Double open end spanner set
- D Doppelmaulschlüsselsatz
- PL Komplet kluczy płaskich

- RUS Набор рожковых ключей
- CZ Souprava plochéy klíčů
- H Kulcskészlet, villás

- RO Set chei fixe
- E Juego de llaves fijas

POUCH & COLOR BOX



DIN 3110

CrV



**10 PCS** 6x7, 8x9, 10x11, 12x13, 14x15, 16x17, 18x19, 20x22, 21x23, 24x27 mm

**YATO** YT-0380 6

**12 PCS** 6x7, 8x9, 10x11, 12x13, 14x15, 16x17, 18x19, 20x22, 21x23, 24x27, 25x28, 30x32 mm

**YATO** YT-0381 8

- GB Double open end spanner
- D Doppelmaulschlüssel
- PL Klucz płaski

- RUS Ключ рожковый
- CZ Plochéy klíč
- H Villáskulcs

- RO Cheie fixă
- E Llave fija

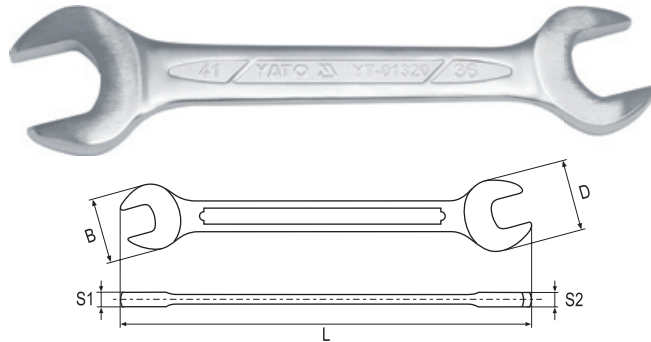

• surface finish:  
chromed, satin

• wykończenie powierzchni:  
chromowana, satynowa

\* - product not for european market  
\* - produkt nieprzeznaczony na rynek europejski



COLOR BOX

| YATO      | Ø (mm) | L (mm) | B (mm) | D (mm) | S1 (mm) | S2 (mm) | PCS packing: |    |
|-----------|--------|--------|--------|--------|---------|---------|--------------|----|
| YT-01320* | 36x41  | 321    | 82     | 70     | 12.2    | 12.2    | 5            | 20 |
| YT-01321* | 41x46  | 371    | 92     | 82     | 13.2    | 13.2    | 5            | 15 |

| YATO      | Ø (mm) | L (mm) | B (mm) | D (mm) | S1 (mm) | S2 (mm) | PCS packing: |    |
|-----------|--------|--------|--------|--------|---------|---------|--------------|----|
| YT-01322* | 46x50  | 403    | 102    | 92     | 13.8    | 13.8    | 5            | 15 |
| YT-01323* | 50x55  | 443    | 112    | 102    | 15.2    | 15.2    | 5            | 10 |

GB Double open end spanner  
D Doppelmaulschlüssel  
PL Klucz płaski  
RUS Ключ рожковый  
CZ Plochý klíč  
H Villáskulcs  
RO Cheie fixă  
E Llave fija



DIN 3110 CrV 6140

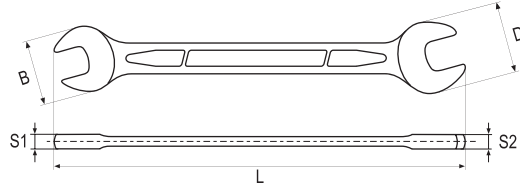

• surface finish:  
chromed, satin  
• wykończenie powierzchni:  
chromowana, satynowa



| YATO    | Ø (mm) | L (mm) | B (mm) | D (mm) | S1 (mm) | S2 (mm) | PCS packing |     |
|---------|--------|--------|--------|--------|---------|---------|-------------|-----|
| YT-0107 | 6x7    | 128    | 15.5   | 17.5   | 3.8     | 3.8     | 10          | 600 |
| YT-0109 | 8x9    | 146    | 19.4   | 21.4   | 4.3     | 4.3     | 10          | 360 |
| YT-0110 | 8x10   | 146    | 19.4   | 21.4   | 4.3     | 4.3     | 10          | 360 |
| YT-0111 | 10x11  | 162    | 23.5   | 25.7   | 5.0     | 5.0     | 10          | 360 |
| YT-0112 | 10x13  | 175    | 27.7   | 30.2   | 5.3     | 5.3     | 10          | 120 |
| YT-0113 | 12x13  | 175    | 27.7   | 30.2   | 5.3     | 5.3     | 10          | 120 |
| YT-0115 | 14x15  | 191    | 31.7   | 33.7   | 5.8     | 5.8     | 10          | 120 |
| YT-0117 | 13x17  | 195    | 31.7   | 38.7   | 6.2     | 6.2     | 10          | 120 |
| YT-0118 | 16x17  | 212    | 36.2   | 38.2   | 6.3     | 6.3     | 10          | 100 |

| YATO    | Ø (mm) | L (mm) | B (mm) | D (mm) | S1 (mm) | S2 (mm) | PCS packing |     |
|---------|--------|--------|--------|--------|---------|---------|-------------|-----|
| YT-0119 | 17x19  | 224    | 40.2   | 42.2   | 6.8     | 6.8     | 10          | 100 |
| YT-0120 | 18x19  | 224    | 40.2   | 42.2   | 6.8     | 6.8     | 10          | 100 |
| YT-0122 | 19x22  | 237    | 44.2   | 48.2   | 7.5     | 7.5     | 10          | 60  |
| YT-0123 | 20x22  | 237    | 44.2   | 48.2   | 7.5     | 7.5     | 10          | 60  |
| YT-0125 | 21x23  | 247    | 46.2   | 50.2   | 7.8     | 7.8     | 10          | 60  |
| YT-0127 | 24x27  | 268    | 53.2   | 57.7   | 8.4     | 8.4     | 5           | 40  |
| YT-0128 | 25x28  | 268    | 53.2   | 57.7   | 8.4     | 8.4     | 5           | 40  |
| YT-0132 | 30x32  | 295    | 64.2   | 68.2   | 9.4     | 9.4     | 5           | 40  |

GB Double open end spanner set  
D Doppelmaulschlüsselsatz  
PL Komplet kluczy płaskich

RUS Набор рожковых ключей  
CZ Souprava plochých klíčů  
H Kulcskészlet, villás

RO Set chei fixe  
E Juego de llaves fijas



DIN 3110

CrV 6140



10 PCS 6x7, 8x9, 10x11, 12x13, 14x15, 16x17, 18x19, 20x22, 21x23, 24x27 mm

YATO YT-0150 6

12 PCS 6x7, 8x9, 10x11, 12x13, 14x15, 16x17, 18x19, 20x22, 21x23, 24x27, 25x28, 30x32 mm

YATO YT-0152 8

GB Double open end spanner  
D Doppelmaulschlüssel  
PL Klucz płaski  
RUS Ключ рожковый  
CZ Plochý klíč  
H Villáskulcs  
RO Cheie fixă  
E Llave fija



S.A.E. DIN 3110 CrV

• surface finish:  
chromed, satin / mirror  
• wykończenie powierzchni:  
chromowana, satynowa / polerowana

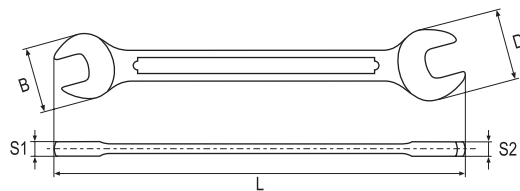

| YATO    | Ø                                 | L (mm) | B (mm) | D (mm) | S1 (mm) | S2 (mm) | PCS packing |         |
|---------|-----------------------------------|--------|--------|--------|---------|---------|-------------|---------|
| YT-4830 | 1/4" (6.3 mm) x 5/16" (7.9 mm)    | 120    | 14.8   | 17.2   | 3.9     | 3.9     | 10          | 150/300 |
| YT-4831 | 3/8" (9.5 mm) x 7/16" (11.1 mm)   | 155    | 22.0   | 25.1   | 4.8     | 4.8     | 10          | 150/300 |
| YT-4832 | 1/2" (12.7 mm) x 9/16" (14.3 mm)  | 185    | 31.2   | 33.4   | 5.8     | 5.8     | 10          | 80/160  |
| YT-4833 | 5/8" (15.9 mm) x 11/16" (17.5 mm) | 200    | 34.6   | 37.2   | 6.0     | 6.1     | 10          | 50/100  |

| YATO    | Ø                                   | L (mm) | B (mm) | D (mm) | S1 (mm) | S2 (mm) | PCS packing |        |
|---------|-------------------------------------|--------|--------|--------|---------|---------|-------------|--------|
| YT-4834 | 11/16" (17.5 mm) x 3/4" (19.0 mm)   | 220    | 38.7   | 41.2   | 7.0     | 7.0     | 10          | 50/100 |
| YT-4835 | 13/16" (20.6 mm) x 7/8" (22.2 mm)   | 235    | 42.7   | 47.0   | 7.0     | 7.0     | 10          | 20/40  |
| YT-4836 | 15/16" (23.8 mm) x 1" (25.4 mm)     | 260    | 51.5   | 56.5   | 8.3     | 8.4     | 5           | 10     |
| YT-4837 | 1-1/8" (28.6 mm) x 1-1/4" (31.8 mm) | 295    | 62.6   | 66.2   | 8.6     | 8.7     | 5           | 10     |

GB Double open end spanner set  
D Doppelmaulschlüsselsatz  
PL Komplet kluczy płaskich  
RUS Набор рожковых ключей  
CZ Souprava plochých klíčů  
H Kulcskészlet, villás  
RO Set chei fixe  
E Juego de llaves fijas



8 PCS S.A.E.

DIN 3110 CrV

1/4" (6.3 mm) x 5/16" (7.9 mm), 3/8" (9.5 mm) x 7/16" (11.1 mm), 1/2" (12.7 mm) x 9/16" (14.3 mm), 5/8" (15.9 mm) x 11/16" (17.5 mm), 11/16" (17.5 mm) x 3/4" (19.0 mm), 13/16" (20.6 mm) x 7/8" (22.2 mm), 15/16" (23.8 mm) x 1" (25.4 mm), 1-1/8" (28.6 mm) x 1-1/4" (31.8 mm)

YATO YT-48371\* 10

\* - product not for european market  
\* - produkt nieprzeznaczony na rynek europejski

GB Double ratchet spanner  
D Ringschlüsselsatz  
PL Klucz oczkowy z grzechotką  
RUS Ключ накидной

CZ Očkové klíč  
H Csillagkulcs  
RO Cheie inelare  
E Llave de anillo



CrV  
6140

72T

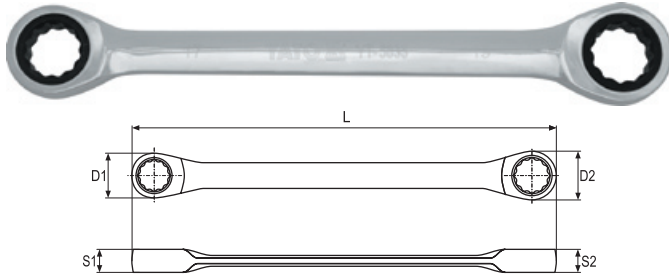

5 PCS  
PCS packing

COLOR BOX

\* - product not for european market  
\* - produkt nieprzeznaczony na rynek europejski

| YATO      | Ø (mm) | L (mm) | D1 (mm) | D2 (mm) | S1 (mm) | S2 (mm) | PCS packing |         |
|-----------|--------|--------|---------|---------|---------|---------|-------------|---------|
| YT-5030   | 8x9    | 125    | 18.4    | 20.2    | 7.2     | 7.5     | 5           | 100/200 |
| YT-50305* | 8x10   | 230    | 18.3    | 21.5    | 7.2     | 7.8     | 5           | 100/200 |
| YT-5031   | 10x11  | 150    | 21.9    | 23.9    | 8.0     | 8.5     | 5           | 100/200 |
| YT-5032   | 12x13  | 170    | 25.4    | 26.5    | 8.9     | 9.0     | 5           | 100/200 |
| YT-5033   | 14x15  | 190    | 27.7    | 29.6    | 9.5     | 9.8     | 5           | 50/100  |
| YT-5034   | 16x18  | 210    | 31.2    | 34.8    | 10.0    | 10.8    | 5           | 50/100  |
| YT-5035   | 17x19  | 235    | 32.5    | 35.7    | 10.5    | 11.8    | 5           | 50/100  |

GB Double ratchet spanner set  
D Ringschlüsselsatz  
PL Klucze oczkowe z grzechotką  
RUS Набор ключей накидных

CZ Očkové klíče  
H Csillagkulcs készlet  
RO Set chei inelare  
E Llaves de anillo

5  
PCS



CrV  
6140

72T



8x9, 10x11, 12x13, 14x15, 17x19 mm

| YATO    | PCS packing |
|---------|-------------|
| YT-5038 | 10/30       |



GB Bi-hexagonal ring spanner  
D Doppelringschlüssel  
PL Klucz oczkowy odgięty  
RUS Ключ накидной изогнутый  
CZ Očkový klíč ohnutý  
H Hajlítottszerű csillagkulcs  
RO Cheie inelaro-curbată  
E Llave de estrella

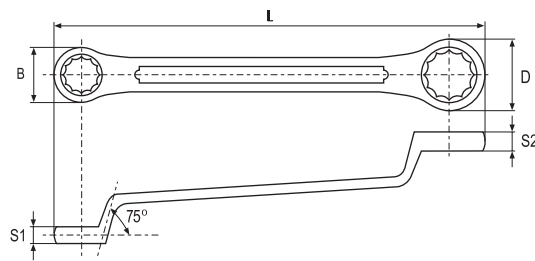

• application: industry  
• surface finish: chromed, satin / mirror  
• przeznaczenie: przemysł  
• wykończenie powierzchni: chromowana, satynowa / polerowana

DIN  
838

CrV

AS-DRIVE

\* - product not for european market  
\* - produkt nieprzeznaczony na rynek europejski



| YATO     | Ø (mm) | L (mm) | B (mm) | D (mm) | S1 (mm) | S2 (mm) | PCS packing |         |
|----------|--------|--------|--------|--------|---------|---------|-------------|---------|
| YT-4840* | 5.5x7  | 165    | 11.1   | 12.4   | 5.4     | 4.9     | 10          | 300/600 |
| YT-0383  | 6x7    | 165    | 11.0   | 12.7   | 5.4     | 5.5     | 10          | 200/400 |
| YT-0384  | 8x9    | 185    | 13.9   | 15.5   | 6.8     | 7.2     | 10          | 100/200 |
| YT-4841* | 8x10   | 180    | 13.6   | 15.3   | 6.1     | 6.4     | 10          | 150/300 |
| YT-4842* | 9x11   | 200    | 16.4   | 17.8   | 7.7     | 7.4     | 10          | 150/300 |
| YT-0385  | 10x11  | 200    | 16.3   | 17.6   | 6.8     | 7.2     | 10          | 100/200 |
| YT-4843* | 10x12  | 195    | 16.6   | 18.1   | 7.0     | 7.7     | 10          | 150/300 |
| YT-4844* | 11x13  | 215    | 19.3   | 20.8   | 8.4     | 8.6     | 10          | 80/160  |
| YT-0386  | 12x13  | 220    | 19.6   | 21.5   | 7.2     | 7.7     | 10          | 60/120  |
| YT-4845* | 12x14  | 215    | 19.4   | 21.3   | 7.6     | 8.1     | 10          | 80/160  |
| YT-4846* | 13x15  | 230    | 22.0   | 23.6   | 8.5     | 9.4     | 10          | 80/160  |
| YT-4847* | 13x16  | 225    | 21.9   | 23.8   | 8.9     | 8.8     | 10          | 80/160  |
| YT-0387  | 14x15  | 230    | 23.6   | 21.9   | 8.9     | 9.1     | 10          | 50/100  |
| YT-4848* | 14x17  | 240    | 21.4   | 25.4   | 8.5     | 9.3     | 10          | 50/100  |

| YATO     | Ø (mm) | L (mm) | B (mm) | D (mm) | S1 (mm) | S2 (mm) | PCS packing |        |
|----------|--------|--------|--------|--------|---------|---------|-------------|--------|
| YT-0388  | 16x17  | 255    | 24.6   | 26.4   | 8.6     | 9.3     | 10          | 30/60  |
| YT-4849* | 16x18  | 250    | 25.2   | 27.1   | 8.9     | 9.4     | 10          | 50/100 |
| YT-4850* | 17x19  | 265    | 26.9   | 28.2   | 10.0    | 10.5    | 5           | 30/60  |
| YT-0389  | 18x19  | 270    | 27.5   | 28.8   | 10.5    | 10.2    | 5           | 25/50  |
| YT-4851* | 19x21  | 285    | 30.1   | 33.0   | 11.6    | 12.7    | 5           | 30/60  |
| YT-0390  | 20x22  | 290    | 30.9   | 33.4   | 10.5    | 11.4    | 5           | 20/40  |
| YT-0391  | 21x23  | 310    | 31.9   | 34.4   | 11.8    | 12.4    | 5           | 20/40  |
| YT-4852* | 22x24  | 315    | 33.6   | 36.2   | 12.7    | 13.0    | 5           | 20/40  |
| YT-4853* | 23x26  | 320    | 36.0   | 40.2   | 14.1    | 14.1    | 5           | 20/40  |
| YT-0392  | 24x27  | 330    | 36.2   | 40.6   | 11.5    | 13.2    | 5           | 20/40  |
| YT-0393  | 25x28  | 355    | 37.8   | 42.1   | 13.6    | 14.8    | 3           | 15/30  |
| YT-4854* | 27x30  | 350    | 40.4   | 43.5   | 14.7    | 14.6    | 5           | 15/30  |
| YT-0394  | 30x32  | 390    | 44.0   | 47.1   | 13.8    | 14.9    | 3           | 15/30  |

GB Bi-hexagonal ring spanner set  
D Doppelringschlüsselsatz  
PL Komplet kluczy oczkowych odgiętych

RUS Набор ключей накидных изогнутых  
CZ Klíče očkové vyhnuté sada  
H Csillagkulcs készlet

RO Set chei inelare cu cot  
E Juego de llaves de estrella acodadas

POUCH  
& COLOR  
BOX



DIN  
838

1

CrV

AS-DRIVE



8  
PCS

6x7, 8x9, 10x11, 12x13, 14x15,  
16x17, 18x19, 20x22 mm

**YATO**

YT-0396



6

12  
PCS

6x7, 8x9, 10x11, 12x13, 14x15,  
16x17, 18x19, 20x22, 21x23, 24x27,  
25x28, 30x32 mm

**YATO**

YT-0398



4

GB Bi-hexagonal ring spanner  
D Doppelringschlüssel  
PL Klucz oczkowy odgięty  
RUS Ключ накидной изогнутый  
CZ Očkový klíč ohnutý  
H Hajlítottszerű csillagkulcs  
RO Cheie inelaro-curbată  
E Llave de estrella

AS-DRIVE

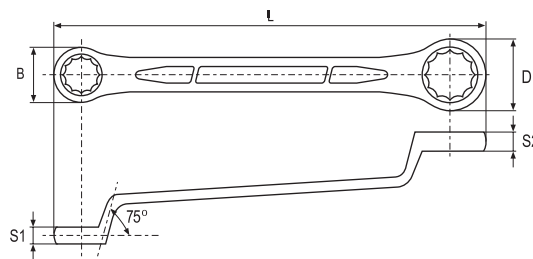

- application: industry
- surface finish: chromed, satin
- przeznaczenie: przemysł
- wykończenie powierzchni: chromowana, satynowa

COLOR BOX



| YATO     | Ø (mm) | L (mm) | B (mm) | D (mm) | S1 (mm) | S2 (mm) | PCS packing |    |
|----------|--------|--------|--------|--------|---------|---------|-------------|----|
| YT-02330 | 32x36  | 408    | 52     | 46     | 17.5    | 17.5    | 5           | 20 |
| YT-02331 | 36x41  | 448    | 58     | 52     | 18.0    | 18.0    | 5           | 20 |
| YT-02332 | 41x46  | 483    | 65     | 58     | 18.5    | 18.5    | 5           | 15 |

| YATO     | Ø (mm) | L (mm) | B (mm) | D (mm) | S1 (mm) | S2 (mm) | PCS packing |    |
|----------|--------|--------|--------|--------|---------|---------|-------------|----|
| YT-02333 | 46x50  | 495    | 71     | 65     | 19.0    | 19.0    | 5           | 10 |
| YT-02334 | 50x55  | 538    | 78     | 71     | 19.5    | 19.5    | 5           | 10 |

GB Bi-hexagonal ring spanner  
D Doppelringschlüssel  
PL Klucz oczkowy odgięty  
RUS Ключ накидной изогнутый  
CZ Očkový klíč ohnutý  
H Hajlítottszerű csillagkulcs  
RO Cheie inelaro-curbată  
E Llave de estrella

DIN  
838

CrV  
6140

AS-DRIVE

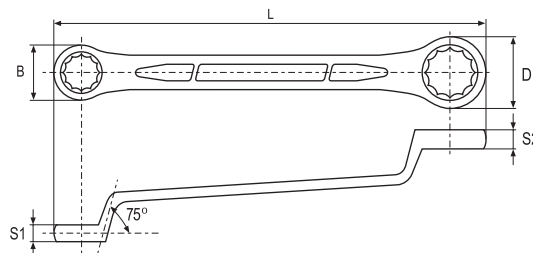

- application: industry
- maximum torque exceeding DIN and ANSI standards by 60%
- surface finish: chromed, satin
- przeznaczenie: przemysł
- maksymalny moment obrotowy większy o 60% niż w standardach DIN i ANSI
- wykończenie powierzchni: chromowana, satynowa

COLOR BOX



| YATO    | Ø (mm) | L (mm) | B (mm) | D (mm) | S1 (mm) | S2 (mm) | PCS packing |     |
|---------|--------|--------|--------|--------|---------|---------|-------------|-----|
| YT-0207 | 6x7    | 168    | 10.4   | 11.9   | 5.7     | 6.2     | 10          | 320 |
| YT-0209 | 8x9    | 183    | 13.3   | 14.8   | 6.7     | 7.2     | 10          | 160 |
| YT-0211 | 10x11  | 198    | 16.3   | 17.7   | 7.7     | 8.8     | 10          | 100 |
| YT-0213 | 12x13  | 217    | 19.2   | 20.6   | 8.7     | 9.2     | 10          | 100 |
| YT-0215 | 14x15  | 239    | 22.1   | 23.4   | 9.6     | 10.1    | 5           | 50  |
| YT-0217 | 16x17  | 260    | 25.0   | 26.4   | 10.6    | 10.9    | 5           | 60  |

| YATO    | Ø (mm) | L (mm) | B (mm) | D (mm) | S1 (mm) | S2 (mm) | PCS packing |    |
|---------|--------|--------|--------|--------|---------|---------|-------------|----|
| YT-0219 | 18x19  | 292    | 27.9   | 29.4   | 11.2    | 11.5    | 5           | 60 |
| YT-0222 | 20x22  | 318    | 30.8   | 33.7   | 11.8    | 12.5    | 5           | 30 |
| YT-0223 | 21x23  | 326    | 32.3   | 35.2   | 12.1    | 12.8    | 5           | 30 |
| YT-0227 | 24x27  | 329    | 36.6   | 40.7   | 13.1    | 14.0    | 5           | 30 |
| YT-0228 | 25x28  | 347    | 38.1   | 42.5   | 14.0    | 14.3    | 2           | 16 |
| YT-0232 | 30x32  | 362    | 45.2   | 49.2   | 15.0    | 15.7    | 2           | 16 |

1

GB Bi-hexagonal ring spanner set  
 D Doppelringschlüsselsatz  
 PL Komplet kluczy oczkowych odgiętych  
 RUS Набор ключей накидных изогнутых  
 CZ Klíče očkové vyhnuté sada

H Csillagkulcs készlet  
 RO Set chei inelare cu cot  
 E Juego de llaves de estrella acodadas

POUCH & COLOR BOX



DIN 838

CrV 6140

AS-DRIVE



**8** PCS  
 6x7, 8x9, 10x11, 12x13, 14x15, 16x17, 18x19, 20x22 mm

**10** PCS  
 6x7, 8x9, 10x11, 12x13, 14x15, 16x17, 18x19, 20x22, 21x23, 24x27 mm

**12** PCS  
 6x7, 8x9, 10x11, 12x13, 14x15, 16x17, 18x19, 20x22, 21x23, 24x27, 25x28, 30x32 mm

|             |   |
|-------------|---|
| <b>YATO</b> |   |
| YT-0248     | 6 |

|             |    |
|-------------|----|
| <b>YATO</b> |    |
| YT-0250     | 10 |

|             |   |
|-------------|---|
| <b>YATO</b> |   |
| YT-0252     | 4 |

GB Bi-hexagonal ring spanner  
 D Doppelringschlüssel  
 PL Klucz oczkowy odgięty  
 RUS Ключ накидной изогнутый  
 CZ Očkový klíč ohnutý  
 H Hajlítottszárú csillagkulcs  
 RO Cheie inelaro-curbată  
 E Llave de estrella

S.A.E. DIN 838

CrV

AS-DRIVE

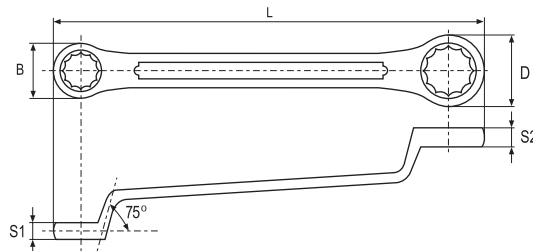

- application: industry
- surface finish: chromed, satin / mirror
- przeznaczenie: przemysł
- wykończenie powierzchni: chromowana, satynowa / polerowana

COLOR BOX



| YATO    | Ø                                 | L (mm) | B (mm) | D (mm) | S1 (mm) | S2 (mm) | PCS packing |         |
|---------|-----------------------------------|--------|--------|--------|---------|---------|-------------|---------|
| YT-4860 | 3/8" (9.5 mm) x 7/16" (11.1 mm)   | 200    | 16.2   | 17.5   | 6.8     | 6.4     | 10          | 150/300 |
| YT-4861 | 1/2" (12.7 mm) x 9/16" (14.3 mm)  | 235    | 21.8   | 23.3   | 8.4     | 8.3     | 10          | 80/160  |
| YT-4862 | 11/16" (17.5 mm) x 3/4" (19.0 mm) | 265    | 27.0   | 28.3   | 10.1    | 10.0    | 10          | 50/100  |

| YATO    | Ø                                 | L (mm) | B (mm) | D (mm) | S1 (mm) | S2 (mm) | PCS packing |       |
|---------|-----------------------------------|--------|--------|--------|---------|---------|-------------|-------|
| YT-4863 | 13/16" (20.6 mm) x 7/8" (22.2 mm) | 280    | 30.5   | 33.3   | 11.1    | 11.9    | 10          | 20/40 |
| YT-4864 | 7/8" (22.2 mm) x 15/16" (23.8 mm) | 305    | 33.2   | 35.9   | 11.8    | 13.3    | 5           | 10    |
| YT-4865 | 15/16" (23.8 mm) x 1" (25.4 mm)   | 325    | 35.8   | 40.0   | 13.6    | 13.7    | 5           | 10    |

GB Bi-hexagonal ring spanner set  
 D Doppelringschlüsselsatz  
 PL Komplet kluczy oczkowych odgiętych  
 RUS Набор ключей накидных изогнутых  
 CZ Klíče očkové vyhnuté sada  
 H Csillagkulcs készlet  
 RO Set chei inelare cu cot  
 E Juego de llaves de estrella acodadas

POUCH



6 PCS

S.A.E. DIN 838

CrV

AS-DRIVE



3/8" (9.5 mm) x 7/16" (11.1 mm),  
 1/2" (12.7 mm) x 9/16" (14.3 mm),  
 11/16" (17.5 mm) x 3/4" (19.0 mm),  
 13/16" (20.6 mm) x 7/8" (22.2 mm),  
 7/8" (22.2 mm) x 15/16" (23.8 mm),  
 15/16" (23.8 mm) x 1" (25.4 mm)

|             |    |
|-------------|----|
| <b>YATO</b> |    |
| YT-48651*   | 10 |

\* - product not for european market  
 \* - produkt nieprzeznaczony na rynek europejski



GB Ring impact wrench  
D Schlagringschlüssel  
PL Klucz do pobijania oczkowy  
RUS Ключ закрытый  
для растряски  
CZ Klíč maticový očkový rázový  
H Űtőcsillagkulcs  
RO Cheie inelară cu bătător  
E Llave de muletilla para usarse  
dando golpes

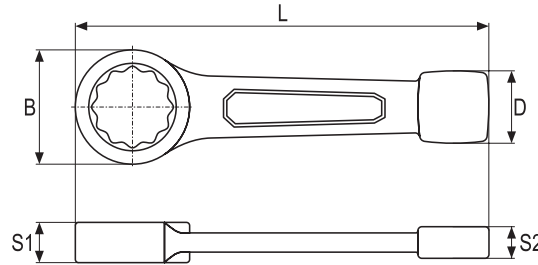

- application: industry
- 12 point profile
- AS-Drive system
- drop forged
- surface finish: black oxidised
- przeznaczenie: przemysł
- profil 12-kątny
- system AS-Drive
- kute
- wykończenie powierzchni: czarna, oksydowana

| YATO    | Ø (mm) | L (mm) | B (mm) | D (mm) | S1 (mm) | S2 (mm) |      |
|---------|--------|--------|--------|--------|---------|---------|------|
| YT-1601 | 24     | 160    | 41     | 31     | 15.0    | 10      | 5/25 |
| YT-1602 | 27     | 185    | 47     | 33     | 15.0    | 12      | 5/25 |
| YT-1603 | 30     | 190    | 51     | 35     | 16.5    | 14      | 5/25 |
| YT-1604 | 32     | 195    | 54     | 37     | 16.5    | 15      | 5/25 |
| YT-1605 | 36     | 210    | 60     | 39     | 20.0    | 17      | 5/10 |
| YT-1606 | 38     | 210    | 60     | 39     | 20.0    | 17      | 5/10 |
| YT-1607 | 41     | 225    | 66     | 42     | 20.0    | 18      | 5/10 |

| YATO    | Ø (mm) | L (mm) | B (mm) | D (mm) | S1 (mm) | S2 (mm) |      |
|---------|--------|--------|--------|--------|---------|---------|------|
| YT-1608 | 46     | 240    | 74     | 44     | 22.0    | 19      | 5/10 |
| YT-1609 | 50     | 250    | 80     | 45     | 23.0    | 20      | 5/10 |
| YT-1610 | 55     | 270    | 86     | 55     | 25.0    | 22      | 5/10 |
| YT-1611 | 58     | 270    | 86     | 55     | 25.0    | 22      | 5    |
| YT-1612 | 60     | 270    | 92     | 60     | 25.0    | 23      | 5    |
| YT-1613 | 65     | 290    | 100    | 65     | 30.0    | 24      | 5    |
| YT-1614 | 70     | 310    | 108    | 70     | 32.0    | 25      | 5    |

GB Ring impact wrench  
D Schlagringschlüssel  
PL Klucz do pobijania oczkowy  
RUS Ключ закрытый  
для растряски  
CZ Klíč maticový očkový rázový  
H Űtőcsillagkulcs  
RO Cheie inelară cu bătător  
E Llave de muletilla para usarse  
dando golpes

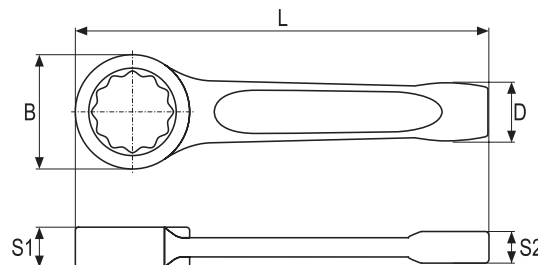

- application: industry
- 12 point profile
- AS-Drive system
- drop forged
- surface finish: black oxidised
- przeznaczenie: przemysł
- profil 12-kątny
- system AS-Drive
- kute
- wykończenie powierzchni: czarna, oksydowana

| YATO     | Ø (mm) | L (mm) | B (mm) | D (mm) | S1 (mm) | S2 (mm) |    |
|----------|--------|--------|--------|--------|---------|---------|----|
| YT-3500* | 75     | 326    | 113    | 62     | 33      | 18      | 10 |
| YT-3501* | 80     | 350    | 124    | 65     | 34      | 19      | 8  |
| YT-3502* | 85     | 355    | 130    | 68     | 36      | 20      | 7  |
| YT-3503* | 90     | 390    | 142    | 72     | 39      | 23      | 5  |
| YT-3504* | 95     | 390    | 142    | 72     | 39      | 23      | 5  |
| YT-3505* | 100    | 420    | 155    | 78     | 43      | 25      | 5  |
| YT-3506* | 105    | 420    | 155    | 78     | 43      | 25      | 5  |
| YT-3507* | 110    | 450    | 168    | 85     | 45      | 28      | 4  |
| YT-3508* | 115    | 450    | 168    | 85     | 45      | 28      | 4  |

| YATO     | Ø (mm) | L (mm) | B (mm) | D (mm) | S1 (mm) | S2 (mm) |   |
|----------|--------|--------|--------|--------|---------|---------|---|
| YT-3509* | 120    | 480    | 182    | 90     | 50      | 30      | 3 |
| YT-3510* | 125    | 480    | 182    | 90     | 50      | 30      | 3 |
| YT-3511* | 130    | 520    | 200    | 95     | 57      | 31      | 2 |
| YT-3512* | 135    | 520    | 200    | 95     | 57      | 31      | 2 |
| YT-3513* | 140    | 520    | 220    | 95     | 57      | 31      | 2 |
| YT-3514* | 145    | 565    | 220    | 104    | 58      | 32      | 2 |
| YT-3515* | 150    | 565    | 220    | 104    | 58      | 32      | 2 |
| YT-3516* | 155    | 565    | 220    | 104    | 58      | 32      | 2 |
| YT-3517* | 160    | 585    | 240    | 113    | 58      | 33      | 1 |

\* - product not for european market  
\* - produkt nieprzeznaczony na rynek europejski

POLYBAG  
WITH LABEL



- GB Open end impact wrench
- D Schlagschraubenschlüssel
- PL Klucz do pobijania płaski
- RUS Ключ плоский для растряски
- CZ Klíč maticový plochý rázový
- H Útőlaposkulcs
- RO Cheie fixă cu bățător
- E Llave de boca abierta para usarse dando golpes

**DROP FORGED KUTE CrV**

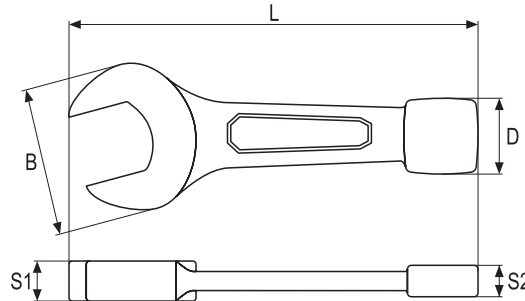

- application: industry
- head offset: 15°
- drop forged
- surface finish: black oxidised
- przeznaczenie: przemysł
- kąt odchylenia główki: 15°
- kute
- wykończenie powierzchni: czarna, oksydowana

| YATO    | Ø (mm) | L (mm) | B (mm) | D (mm) | S1 (mm) | S2 (mm) |      |
|---------|--------|--------|--------|--------|---------|---------|------|
| YT-1615 | 27     | 180    | 55     | 33     | 15      | 12      | 5/25 |
| YT-1616 | 30     | 187    | 63     | 35     | 17      | 14      | 5/25 |
| YT-1617 | 32     | 195    | 67     | 37     | 18      | 15      | 5/25 |
| YT-1618 | 36     | 210    | 77     | 39     | 18      | 17      | 5/10 |

| YATO    | Ø (mm) | L (mm) | B (mm) | D (mm) | S1 (mm) | S2 (mm) |      |
|---------|--------|--------|--------|--------|---------|---------|------|
| YT-1619 | 41     | 225    | 89     | 42     | 20      | 18      | 5/10 |
| YT-1620 | 46     | 255    | 98     | 44     | 20      | 19      | 5/10 |
| YT-1621 | 50     | 280    | 107    | 45     | 22      | 20      | 5    |
| YT-1622 | 55     | 310    | 118    | 55     | 25      | 22      | 5    |

- GB Open end impact wrench
- D Schlagschraubenschlüssel
- PL Klucz do pobijania płaski
- RUS Ключ плоский для растряски
- CZ Klíč maticový plochý rázový
- H Útőlaposkulcs
- RO Cheie fixă cu bățător
- E Llave de boca abierta para usarse dando golpes

**DROP FORGED KUTE CrV**

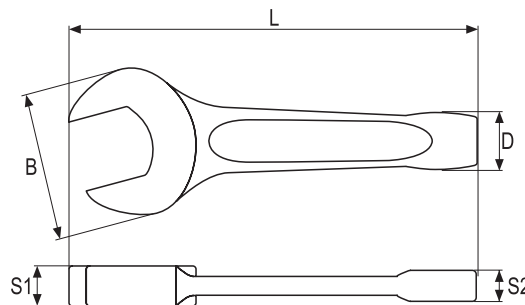

- application: industry
- head offset: 15°
- drop forged
- surface finish: black oxidised
- przeznaczenie: przemysł
- kąt odchylenia główki: 15°
- kute
- wykończenie powierzchni: czarna, oksydowana

| YATO     | Ø (mm) | L (mm) | B (mm) | D (mm) | S1 (mm) | S2 (mm) |    |
|----------|--------|--------|--------|--------|---------|---------|----|
| YT-3518* | 60     | 315    | 128    | 52.0   | 23.5    | 15      | 10 |
| YT-3519* | 65     | 335    | 141    | 59.0   | 27.5    | 16      | 8  |
| YT-3520* | 70     | 370    | 156    | 61.5   | 28.5    | 17      | 6  |
| YT-3521* | 75     | 375    | 162    | 65.0   | 29.0    | 18      | 7  |
| YT-3522* | 80     | 400    | 174    | 72.0   | 32.0    | 19      | 5  |
| YT-3523* | 85     | 400    | 174    | 72.0   | 32.0    | 19      | 5  |
| YT-3524* | 90     | 445    | 194    | 80.0   | 36.0    | 20      | 4  |
| YT-3525* | 95     | 445    | 194    | 80.0   | 36.0    | 20      | 4  |
| YT-3526* | 100    | 485    | 228    | 86.0   | 43.0    | 23      | 3  |
| YT-3527* | 105    | 485    | 228    | 86.0   | 43.0    | 23      | 3  |

| YATO     | Ø (mm) | L (mm) | B (mm) | D (mm) | S1 (mm) | S2 (mm) |   |
|----------|--------|--------|--------|--------|---------|---------|---|
| YT-3528* | 110    | 513    | 238    | 95.0   | 45.0    | 25      | 2 |
| YT-3529* | 115    | 513    | 238    | 95.0   | 45.0    | 25      | 2 |
| YT-3530* | 120    | 530    | 253    | 98.0   | 51.0    | 27      | 2 |
| YT-3531* | 125    | 530    | 253    | 98.0   | 51.0    | 27      | 2 |
| YT-3532* | 130    | 560    | 268    | 105.0  | 53.0    | 29      | 2 |
| YT-3533* | 135    | 560    | 268    | 105.0  | 53.0    | 29      | 2 |
| YT-3534* | 140    | 630    | 290    | 120.0  | 56.0    | 32      | 1 |
| YT-3535* | 145    | 630    | 290    | 120.0  | 56.0    | 32      | 1 |
| YT-3536* | 150    | 630    | 290    | 120.0  | 56.0    | 32      | 1 |

POLYBAG WITH LABEL



\* - product not for european market  
\* - produkt nieprzeznaczony na rynek europejski

GB Half-moon spanner  
D Starter- und Blockschlüssel  
PL Klucz oczkowy typu „C”  
RUS Ключ накидной изогнутый „С”  
CZ Klič očkochlý typ „C”  
H Félhold alakú csillagkulcs  
RO Cheie inelara semi-luna  
E Llave de estrella tipo „C”

- application: industry
- excellent for work in tight spaces
- used for dismantling of collector tubes, alternators and starters
- surface finish: chromed, satin
- przeznaczenie: przemysł
- do pracy w miejscach szczególnie trudnodostępnych
- ułatwia odkręcanie kolektorów, alternatorów i rozruszników samochodowych
- wykończenie powierzchni: chromowana, satynowa

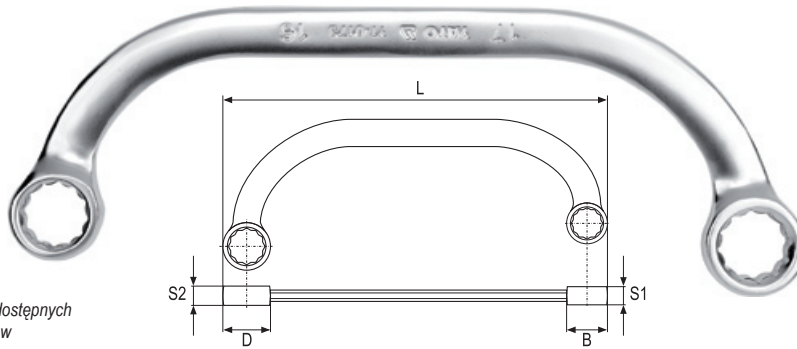

CrV 6140 AS-DRIVE

| YATO    | Ø (mm) | L (mm) | B (mm) | D (mm) | S1 (mm) | S2 (mm) | Box   |
|---------|--------|--------|--------|--------|---------|---------|-------|
| YT-0170 | 10x12  | 145    | 16.8   | 19.2   | 6.8     | 6.8     | 10/60 |
| YT-0171 | 11x13  | 170    | 18.5   | 21.2   | 8.4     | 8.6     | 10/60 |
| YT-0172 | 14x15  | 195    | 22.8   | 25.8   | 9.2     | 9.9     | 10/60 |

| YATO    | Ø (mm) | L (mm) | B (mm) | D (mm) | S1 (mm) | S2 (mm) | Box   |
|---------|--------|--------|--------|--------|---------|---------|-------|
| YT-0173 | 16x17  | 220    | 26.2   | 28.6   | 9.9     | 10.5    | 10/60 |
| YT-0175 | 19x22  | 260    | 28.7   | 32.9   | 10.4    | 10.9    | 6/60  |

GB Reversible half-moon spanner  
D Doppelringratschenschlüssel  
PL Klucz typu „C” z grzechotką  
RUS Ключ накидной изогнутый с трехзубкой  
CZ Klič očkochlý ráčnový typu „C”  
H Csillagkulcs racsnis hajlított  
RO Cheie reversibila semi-luna  
E Llave de carraca de dos bocas con angulo

- application: industry
- minimum operation angle: 5°
- direction switch
- excellent for work in tight spaces
- used for dismantling of collector tubes, alternators and starters
- surface finish: chromed, mirror
- przeznaczenie: przemysł
- minimalny kąt pracy: 5°
- zmiana kierunku obrotu
- do pracy w miejscach szczególnie trudnodostępnych
- ułatwia odkręcanie kolektorów, alternatorów i rozruszników samochodowych
- wykończenie powierzchni: chromowana, polerowana

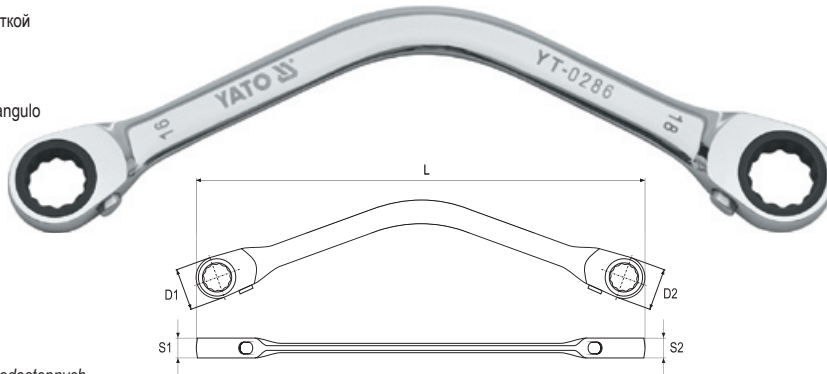

BATCHET FIREBOND 72T

CrV 6140 AS-DRIVE

PLASTIC HANGER



\* - product not for european market  
\* - produkt nieprzeznaczony na rynek europejski

| YATO     | Ø (mm) | L (mm) | D1 (mm) | D2 (mm) | S1 (mm) | S2 (mm) | Box    |
|----------|--------|--------|---------|---------|---------|---------|--------|
| YT-0283  | 10x11  | 192    | 21.0    | 21.9    | 8.4     | 8.4     | 10/100 |
| YT-0284  | 12x15  | 206    | 23.6    | 28.2    | 8.4     | 8.4     | 10/100 |
| YT-0285* | 13x14  | 229    | 25.4    | 27.0    | 8.4     | 8.4     | 10/100 |

| YATO    | Ø (mm) | L (mm) | D1 (mm) | D2 (mm) | S1 (mm) | S2 (mm) | Box    |
|---------|--------|--------|---------|---------|---------|---------|--------|
| YT-0286 | 16x18  | 247    | 28.6    | 31.7    | 10.0    | 11.5    | 10/100 |
| YT-0287 | 17x19  | 260    | 29.7    | 33.8    | 10.0    | 11.5    | 10/100 |

GB Flare nut wrench  
D Schraubenschlüssel, halboffen  
PL Klucz oczkowy półotwarty  
RUS Ключ накладной полуоткрытый

CZ Klič prstencový polootevřený  
H Csuklós, nyitott  
RO Cheie inelară semideschisă  
E Llave semiabierta

CrV 6140

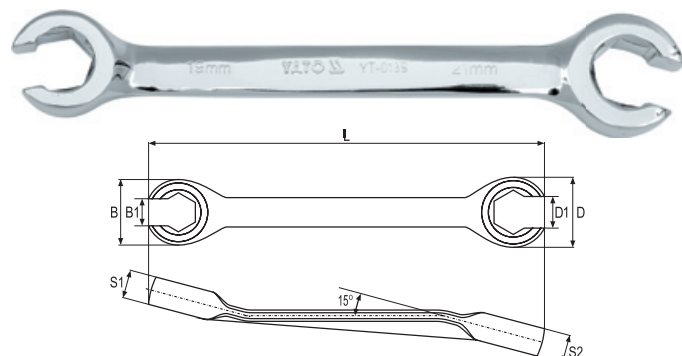

| YATO    | Ø (mm) | L (mm) | B (mm) | D (mm) | B1 (mm) | D1 (mm) | S1 (mm) | S2 (mm) | PCS | packing: |
|---------|--------|--------|--------|--------|---------|---------|---------|---------|-----|----------|
| YT-0135 | 8x10   | 140    | 18.7   | 21.8   | 6.2     | 7.2     | 7.7     | 8.4     | 10  | 200/400  |
| YT-0136 | 11x12  | 160    | 21.2   | 24.0   | 8.1     | 9.2     | 8.5     | 9.5     | 10  | 100/200  |
| YT-0137 | 13x14  | 175    | 26.3   | 27.3   | 9.6     | 10.7    | 9.6     | 10.5    | 10  | 100/200  |
| YT-0138 | 15x17  | 190    | 31.2   | 31.2   | 11.8    | 13.0    | 11.5    | 10.9    | 10  | 50/100   |
| YT-0139 | 19x21  | 230    | 36.3   | 42.1   | 14.7    | 16.7    | 12.4    | 12.8    | 10  | 50/100   |
| YT-0140 | 22x24  | 250    | 42.7   | 44.2   | 17.1    | 18.6    | 13.2    | 13.9    | 10  | 50/100   |

GB Flare nut wrench set  
D Schraubenschlüssel, halboffen  
PL Zestaw kluczy oczkowych półotwartych  
RUS Ключ накладной полуоткрытый

CZ Klič prstencový polootevřený  
H Csuklós, nyitott  
RO Cheie inelară semideschisă  
E Llave semiabierta

4 PCS



CrV 6140



8x10, 11x12, 13x14, 15x17 mm

| YATO    | Box   |
|---------|-------|
| YT-0143 | 25/50 |

GB Flexible flare nut wrench  
D Schraubenschlüssel, halboffen mit Gelenk

PL Klucz oczkowy półotwarty z przegubem

RUS Ключ накладной полуоткрытый с шарниром

CZ Klíč prstencový polootevřený s kloubem

H Csuklós, nyitott csillagkulcs

RO Cheie inelară semideschisă, cu articulație

E Llave semiabierta con una junta

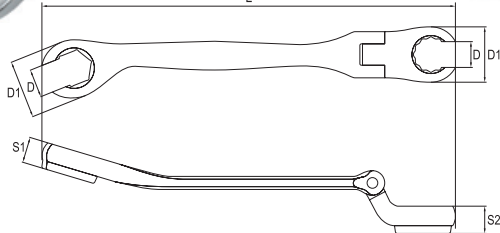
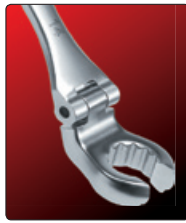

- application: industry
- articulated joint at 12 point head
- ring for nuts in sockets
- for use on hydraulic lines
- for use on fuel lines
- for use on brake system lines
- ergonomic handle
- surface finish: chromed, satin

- przeznaczenie: przemysł
- przegub przy profilu 12-kątnym
- pierścien do gniazd nakrętek
- do przewodów hydraulicznych
- do przewodów paliwowych
- do przewodów hamulcowych
- ergonomiczna rączka
- wykończenie powierzchni: chromowana, satynowa

PLASTIC HANGER

| YATO    | Ø (mm) | L (mm) | D (mm) | D1 (mm) | S1 (mm) | S2 (mm) | Box    |
|---------|--------|--------|--------|---------|---------|---------|--------|
| YT-0180 | 8      | 128    | 6.0    | 18.0    | 7.0     | 7.0     | 24/288 |
| YT-0181 | 9      | 128    | 6.5    | 18.0    | 7.0     | 7.0     | 24/288 |
| YT-0182 | 10     | 128    | 7.0    | 18.0    | 7.0     | 7.0     | 24/288 |
| YT-0183 | 11     | 146    | 8.5    | 22.0    | 9.0     | 9.0     | 24/216 |
| YT-0184 | 12     | 148    | 9.0    | 22.0    | 9.0     | 9.0     | 24/216 |
| YT-0185 | 13     | 175    | 10.0   | 26.0    | 11.0    | 11.0    | 12/120 |
| YT-0186 | 14     | 175    | 11.0   | 26.0    | 11.0    | 11.0    | 12/120 |
| YT-0187 | 15     | 175    | 12.0   | 26.0    | 11.0    | 11.0    | 12/120 |
| YT-0188 | 17     | 190    | 14.0   | 32.0    | 13.0    | 13.0    | 12/96  |

GB Flexible flare nut wrench set  
D Schraubenschlüssel, halboffen mit Gelenk

PL Komplet kluczy oczkowych półotwartych z przegubem

RUS Ключ накладной полуоткрытый с шарниром

CZ Klíč prstencový polootevřený s kloubem

H Csuklós, nyitott csillagkulcs

RO Cheie inelară semideschisă, cu articulație

E Llave semiabierta con una junta

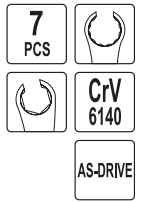

8, 10, 11, 12, 13, 14, 17 mm

PLASTIC HANGER

| YATO    | Box  |
|---------|------|
| YT-0190 | 5/20 |

GB Torx ring spanner set

D Torx-Ringschlüsselsatz

PL Komplet kluczy oczkowych Torx

RUS Набор накидных ключей

CZ Očkové klíče

H Csillagkulcs készlet

RO Cheie inelare

E Llaves de anillo Torx



E6xE8, E10xE12, E14xE18, E20xE24

SLIDING CARD

| YATO    | Box   |
|---------|-------|
| YT-0530 | 10/60 |

GB L-type socket wrench

D Steckschlüssel gebogen

PL Klucz nasadowy typu „L”

RUS Ключ торцевой „L” типа

CZ Nástrčný klíč fajfkový

H Kulcs, dugó-pipa

RO Cheie tubulara cu cot tip „L”

E Llave de vaso „L”

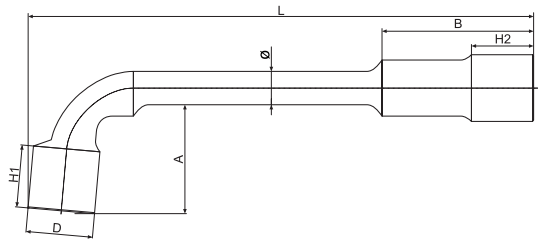

| YATO    | Ø (mm) | L (mm) | B (mm) | H1 (mm) | H2 (mm) | A (mm) | D (mm) | Ø (mm) | Box   |
|---------|--------|--------|--------|---------|---------|--------|--------|--------|-------|
| YT-1626 | 6      | 102    | 25.0   | 10.0    | 11.0    | 16.0   | 10.0   | 7      | 12/60 |
| YT-1627 | 7      | 106    | 27.0   | 10.2    | 10.1    | 21.0   | 10.7   | 7      | 12/60 |
| YT-1628 | 8      | 117    | 29.5   | 12.3    | 11.9    | 18.5   | 12.2   | 9      | 12/60 |
| YT-1629 | 9      | 121    | 31.7   | 13.4    | 12.8    | 19.1   | 13.2   | 10     | 12/60 |
| YT-1630 | 10     | 131    | 35.1   | 16.4    | 16.9    | 23.3   | 15.0   | 10     | 12/60 |
| YT-1631 | 11     | 138    | 36.0   | 16.5    | 16.8    | 24.7   | 16.3   | 11     | 12/60 |
| YT-1632 | 12     | 147    | 42.5   | 17.9    | 18.2    | 17.9   | 18.0   | 12     | 12/60 |
| YT-1633 | 13     | 154    | 44.2   | 18.5    | 19.1    | 30.1   | 19.3   | 12     | 12/60 |
| YT-1634 | 14     | 162    | 47.0   | 19.3    | 20.3    | 30.2   | 20.8   | 13     | 12/60 |
| YT-1635 | 15     | 173    | 48.9   | 20.6    | 21.6    | 31.6   | 22.3   | 13     | 12/60 |
| YT-1636 | 16     | 182    | 55.0   | 23.2    | 23.1    | 37.3   | 23.6   | 14     | 12/60 |
| YT-1637 | 17     | 188    | 57.0   | 25.1    | 25.5    | 37.9   | 25.1   | 14     | 12/36 |
| YT-1638 | 18     | 192    | 57.1   | 25.1    | 24.6    | 40.1   | 26.0   | 14     | 12/36 |

| YATO    | Ø (mm) | L (mm) | B (mm) | H1 (mm) | H2 (mm) | A (mm) | D (mm) | Ø (mm) | Box   |
|---------|--------|--------|--------|---------|---------|--------|--------|--------|-------|
| YT-1639 | 19     | 207    | 62.3   | 26.9    | 27.4    | 41.6   | 28.2   | 16     | 12/36 |
| YT-1640 | 20     | 215    | 62.4   | 27.0    | 28.3    | 42.4   | 29.2   | 16     | 6/24  |
| YT-1641 | 21     | 221    | 65.0   | 30.5    | 30.6    | 54.0   | 30.2   | 16     | 6/24  |
| YT-1642 | 22     | 232    | 67.5   | 30.8    | 30.6    | 49.1   | 31.7   | 16     | 6/24  |
| YT-1643 | 23     | 242    | 77.1   | 31.4    | 31.2    | 51.6   | 33.0   | 17     | 6/18  |
| YT-1644 | 24     | 253    | 78.2   | 32.3    | 31.7    | 53.5   | 33.6   | 17     | 6/18  |
| YT-1645 | 25     | 265    | 81.4   | 34.3    | 35.6    | 55.6   | 35.4   | 19     | 6/18  |
| YT-1646 | 26     | 268    | 77.5   | 35.3    | 30.2    | 57.4   | 36.8   | 19     | 6/12  |
| YT-1647 | 27     | 288    | 85.3   | 36.9    | 36.4    | 54.7   | 37.6   | 20     | 6/12  |
| YT-1648 | 28     | 295    | 87.6   | 37.8    | 37.8    | 60.6   | 39.2   | 20     | 6/12  |
| YT-1649 | 30     | 310    | 95.0   | 38.4    | 38.6    | 65.3   | 42.0   | 22     | 6/12  |
| YT-1650 | 32     | 339    | 99.2   | 40.4    | 40.5    | 66.8   | 43.8   | 22     | 6     |

GB Open end swivel head socket wrench  
D Maul-Steckschlüssel  
PL Klucz płasko-nasadowy przegubowy  
RUS Ключ рожково-торцевой

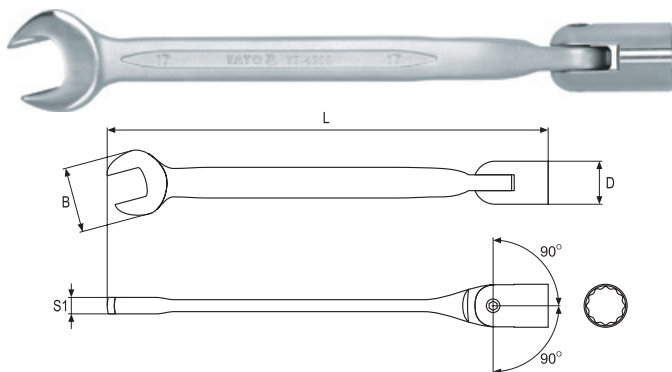

CZ Klic nasad. ploch.  
H Kulcs villás-dugó  
RO Cheie fixe-tubulare  
E Combinada con vaso

CrV  
6140



COLOR BOX



| YATO  | Ø (mm) | L (mm) | B (mm) | D (mm) | S1 (mm) | PCS<br>packing |  |
|--|--------|--------|--------|--------|---------|----------------|---|
| YT-4950  | 8      | 168    | 19.5   | 12.9   | 6.0     | 10             | 240   |
| YT-4951  | 10     | 178    | 20.7   | 14.6   | 6.4     | 10             | 240   |
| YT-4952  | 11     | 188    | 25.4   | 15.9   | 6.9     | 10             | 200   |
| YT-4953  | 12     | 191    | 25.3   | 17.9   | 6.7     | 10             | 160   |
| YT-4954  | 13     | 205    | 28.8   | 18.8   | 6.8     | 10             | 120   |
| YT-4955  | 14     | 222    | 31.8   | 19.8   | 6.8     | 10             | 80  |
| YT-4956  | 17     | 232    | 37.0   | 23.9   | 7.8     | 10             | 80  |
| YT-4957  | 19     | 248    | 42.1   | 25.8   | 7.5     | 10             | 60  |

GB Double flexible socket wrench  
D Steckschlüssel  
PL Klucz nasadowy przegubowy  
RUS Ключ торцевой

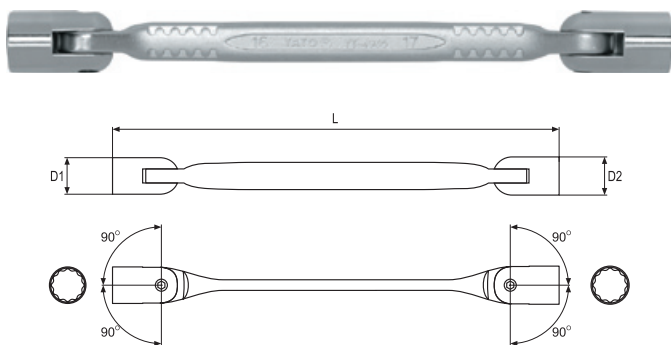

CZ Nástrčné kľíče kloubové  
H Csuklós dugókulcs  
RO Set chei tubulare cu articulatie  
E Llave de vaso articulado

CrV  
6140



COLOR BOX



| YATO  | Ø (mm) | L (mm) | D1 (mm) | D2 (mm) | PCS<br>packing |  |
|--|--------|--------|---------|---------|----------------|---|
| YT-4961  | 8x9    | 183    | 12.9    | 13.7    | 10             | 200   |
| YT-4962  | 10x11  | 202    | 14.6    | 15.8    | 10             | 160   |
| YT-4963  | 12x13  | 218    | 17.6    | 18.8    | 10             | 120   |
| YT-4964  | 14x15  | 239    | 19.8    | 21.7    | 10             | 80  |
| YT-4965  | 16x17  | 257    | 23.8    | 23.9    | 10             | 40  |
| YT-4966  | 18x19  | 274    | 25.8    | 25.8    | 10             | 40  |

GB Open end swivel head socket wrench set  
D Maul-Steckschlüsselsatz  
PL Klucze płasko-nasadowe przegubowe  
RUS Ключи рожк.-торц.-наѡр  
CZ Ploché nřstrčné kľíče kloubové  
H Kulcs villás-csuklós dugó  
RO Set chei fixe + tubulare  
E Combinadas con vaso articulado

6  
PCS

CrV  
6140



POUCH  
& COLOR BOX



8, 10, 12, 13, 17, 19 mm

| YATO  |  |
|--|---|
| YT-4960  | 20  |

GB Double ended swivel socket wrench set  
D Doppelgelenkschlüsselsatz  
PL Klucze nasadowo-przegubowe  
RUS Ключи рожк.-торц.-наѡр  
CZ Nástrčné kľíče kloubové  
H Csuklós dugókulcs  
RO Set chei tubulare cu articulatie  
E Llave de vaso articulado

6  
PCS

CrV  
6140



POUCH  
& COLOR BOX



8x9, 10x11, 12x13, 14x15, 16x17, 18x19 mm

| YATO  |  |
|--|---|
| YT-4967  | 12  |

1

- GB Heavy duty tubular socket wrench
- D Rohrsteckschlüsselsatz
- PL Klucz rurowy kuty
- RUS Ключ двухлучевой с головками
- CZ Klíče trubkové
- H Csökulcs
- RO Cheie pt. țevi
- E Llave de tubería



CrV 40 AS-DRIVE

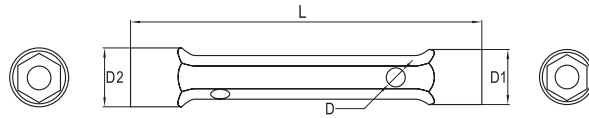

COLOR BOX



| YATO    | Ø (mm) | D1 (mm) | D2 (mm) | D (mm) | L (mm) | PCS packing | Box    |
|---------|--------|---------|---------|--------|--------|-------------|--------|
| YT-4915 | 8x9    | 13      | 14      | 3      | 110    | 10          | 60/240 |
| YT-4916 | 10x11  | 15      | 16      | 5      | 120    | 10          | 60/240 |
| YT-4917 | 12x13  | 18      | 19      | 6      | 140    | 10          | 60/120 |
| YT-4918 | 14x15  | 20      | 22      | 6      | 145    | 10          | 60/120 |
| YT-4919 | 16x17  | 23      | 24      | 7      | 155    | 10          | 60/120 |
| YT-4920 | 18x19  | 25      | 26      | 8      | 165    | 5           | 40/80  |

| YATO    | Ø (mm) | D1 (mm) | D2 (mm) | D (mm) | L (mm) | PCS packing | Box   |
|---------|--------|---------|---------|--------|--------|-------------|-------|
| YT-4921 | 20x22  | 28      | 30      | 8      | 170    | 5           | 30/60 |
| YT-4922 | 21x23  | 29      | 31      | 10     | 185    | 5           | 30/60 |
| YT-4923 | 24x26  | 33      | 35      | 12     | 190    | 5           | 40    |
| YT-4924 | 25x28  | 34      | 37      | 12     | 205    | 5           | 40    |
| YT-4925 | 27x29  | 37      | 39      | 12     | 210    | 5           | 40    |
| YT-4926 | 30x32  | 40      | 42      | 13     | 210    | 5           | 20    |

- GB Tubular socket wrench handle
- D Stellstab für Rohrschlüssel
- PL Pokręto do kluczy rurowych
- RUS Вороток к трубчатым ключам
- CZ Tyčka k trubkovým klíčům
- H Forgatókar dugókulcshoz
- RO Clupă pt. chei tubulare
- E Mango para las llaves de tubo

CrV 40

COLOR BOX



| YATO    | L (mm) | mm                        | PCS packing | Box |
|---------|--------|---------------------------|-------------|-----|
| YT-4927 | 190    | 2.5; 4.5; 5.5             | 50          | 150 |
| YT-4928 | 280    | 6.5; 7.5; 9.5; 11.5; 12.5 | 50          | 100 |

- GB Ratchet wrench
- D Gerüstratsche
- PL Klucz nasadkowy z grzechotką
- RUS Ключ торцовый с трещоткой
- CZ Ráčnový klíč průchozí
- H Kettős racsnis kulcs
- RO Cheie tubulara cu clichet
- E Llave de vaso con carraca



CrV 32T COLD FORGED KUTE NA ZIMNO

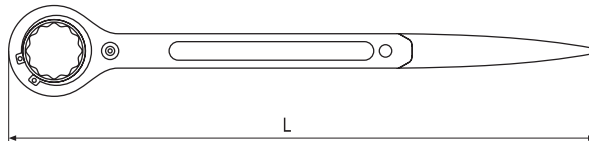

PLASTIC HANGER



| YATO    | Ø (mm) | L (mm) | Box  |
|---------|--------|--------|------|
| YT-4937 | 19x22  | 315    | 2/40 |

- GB Double ratchet wrench
- D Gerüstratsche
- PL Dwustronny klucz nasadkowy z grzechotką
- RUS Ключ торцовый с трещоткой
- CZ Ráčnový klíč průchozí dvoustranný
- H Kettős racsnis kulcs
- RO Cheie tubulara dubla cu clichet
- E Llave de vaso con carraca



CrV 72T RATCHET WRENCH

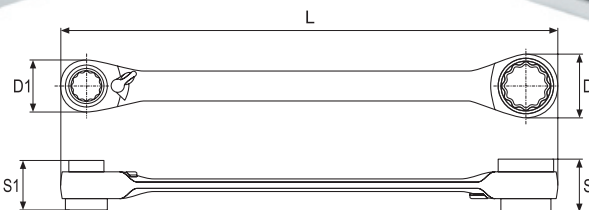

DOUBLE BLISTER



| YATO    | Ø (mm)      | L (mm) | D1 (mm) | D2 (mm) | S1 (mm) | S2 (mm) | Box  |
|---------|-------------|--------|---------|---------|---------|---------|------|
| YT-4945 | 10x13x17x19 | 200    | 29      | 35      | 17      | 22      | 5/50 |

- GB Socket wrench with handle
- D Steckschlüssel
- PL Klucz nasadowy z rączką
- RUS Ключ торцевой
- CZ Nástrčný klíč
- H Kulcs
- RO Cheie tubulara
- E Llave

COLOR BOX

CrV HRC 44

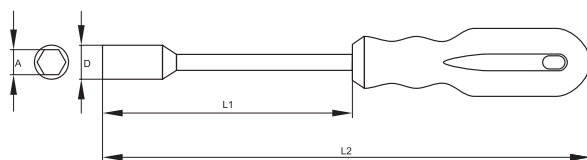

| YATO    | Ø (mm) | D (mm) | L1 (mm) | L2 (mm) | PCS packing | Box |
|---------|--------|--------|---------|---------|-------------|-----|
| YT-1541 | 5      | 8.0    | 125     | 242     | 6           | 120 |
| YT-1542 | 6      | 9.1    | 125     | 242     | 6           | 120 |
| YT-1543 | 7      | 10.9   | 125     | 242     | 6           | 120 |
| YT-1544 | 8      | 12.0   | 125     | 242     | 6           | 120 |
| YT-1545 | 9      | 13.0   | 125     | 242     | 6           | 120 |
| YT-1546 | 10     | 14.1   | 125     | 242     | 6           | 120 |
| YT-1547 | 11     | 15.9   | 125     | 242     | 6           | 120 |
| YT-1548 | 12     | 16.9   | 125     | 242     | 6           | 120 |
| YT-1549 | 13     | 18.0   | 125     | 242     | 6           | 120 |

GB T-type deep socket wrench with rotary handle  
D Steckschlüssel vom Typ „T“ mit drehbarem Handgriff  
PL Klucz nasadowy typu „T” z obrotową rękojeścią  
RUS Торцовый ключ типа „Т” с вращательной ручкой

CZ Klič nástrčný typ „T” s otočnou rukojeťou  
H „T” típusú dugókulcs, forgatható karral  
RO Cheie tubulară de tip „T” cu mâner rotativ  
E Llave tubular „T” con un mango giratorio

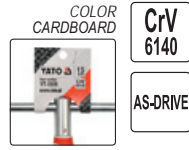

CrV  
6140

AS-DRIVE

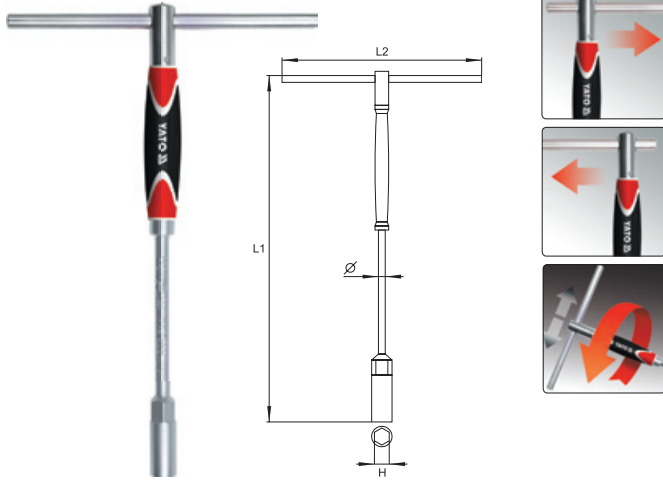

- ergonomic handle
- movable handle with position locking system
- long bar for work in deep set, difficult to reach places
- ergonomiczna rękojeść
- przesuwane pokrętko z blokadą położenia
- długi trzpień umożliwiający pracę w głębokich wnękach

| YATO    | Ø H   | L1 (mm) | L2 (mm) | Ø (mm) |       |
|---------|-------|---------|---------|--------|-------|
| YT-1552 | 8 mm  | 310     | 200     | 10     | 10/40 |
| YT-1553 | 9 mm  | 310     | 200     | 10     | 10/40 |
| YT-1554 | 10 mm | 310     | 200     | 10     | 10/40 |
| YT-1555 | 11 mm | 310     | 200     | 10     | 10/40 |
| YT-1556 | 12 mm | 310     | 200     | 10     | 10/40 |
| YT-1557 | 13 mm | 310     | 200     | 10     | 10/40 |
| YT-1558 | 14 mm | 310     | 200     | 10     | 10/40 |
| YT-1559 | 15 mm | 310     | 200     | 10     | 10/40 |

GB T-type adapter with rotary handle  
D Adapter vom Typ „T” mit drehbarem Handgriff  
PL Adapter typu „T” z obrotową rękojeścią  
RUS Адаптер типа „Т” с вращательной ручкой  
CZ Adaptér typu „T” s otočnou rukojeťou  
H „T” típusú adapter, forgatható karral  
RO Adaptor tip „T” cu mâner rotativ  
E Adaptador „T” con un mango giratorio

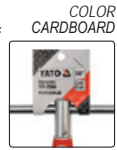

1/4" 3/8" 1/2"  
6.3 mm 10 mm 12.5 mm  
CrV  
6140

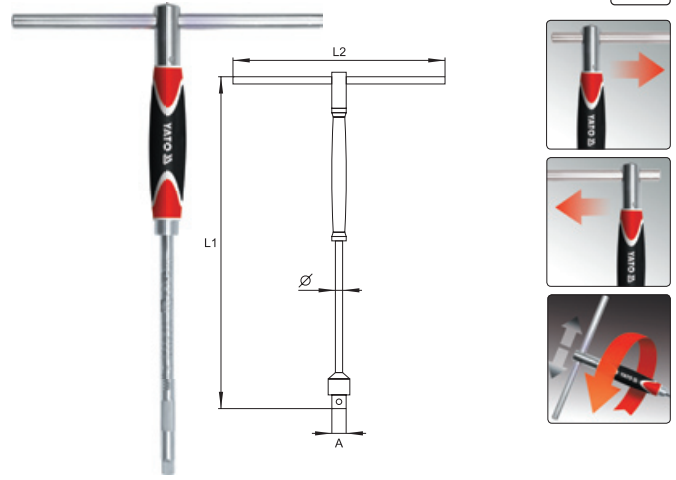

- ergonomic handle
- movable handle with position locking system
- long bar for work in deep set, difficult to reach places
- ergonomiczna rękojeść
- przesuwane pokrętko z blokadą położenia
- długi trzpień umożliwiający pracę w głębokich wnękach

| YATO    | Ø H            | L1 (mm) | L2 (mm) | Ø (mm) |       |
|---------|----------------|---------|---------|--------|-------|
| YT-1565 | 1/4" (6.3 mm)  | 310     | 200     | 8      | 10/40 |
| YT-1566 | 3/8" (9.5 mm)  | 310     | 200     | 10     | 10/40 |
| YT-1567 | 1/2" (12.7 mm) | 310     | 200     | 10     | 10/40 |

GB T-type deep socket wrench  
D Steckschlüssel vom Typ „T”  
PL Klucz nasadowy typu „T”  
RUS Торцовый ключ типа „Т”

CZ Klič nástrčný typ „Y”  
H „Y” típusú dugókulcs  
RO Cheie tubulară de tip „Y”  
E Llave tubular „Y”

CrV  
6140

AS-DRIVE

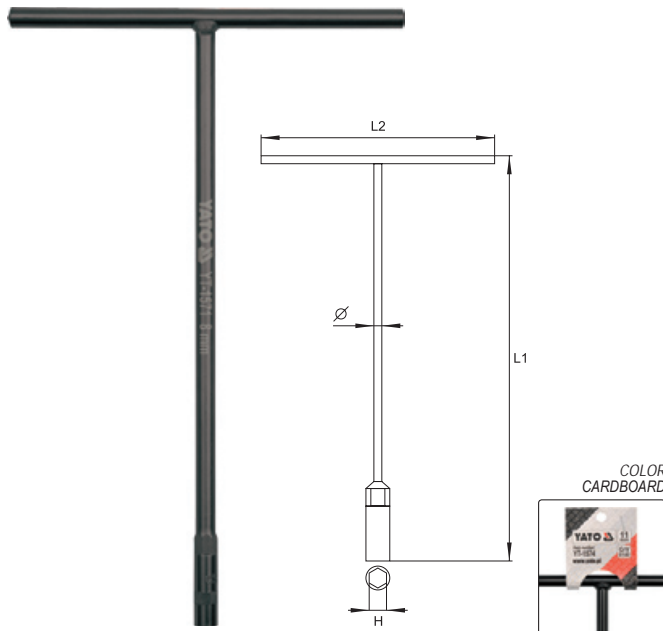

| YATO    | Ø H   | L1 (mm) | L2 (mm) | Ø (mm) |       |
|---------|-------|---------|---------|--------|-------|
| YT-1571 | 8 mm  | 310     | 200     | 10     | 10/40 |
| YT-1572 | 9 mm  | 310     | 200     | 10     | 10/40 |
| YT-1573 | 10 mm | 310     | 200     | 10     | 10/40 |
| YT-1574 | 11 mm | 310     | 200     | 10     | 10/40 |
| YT-1575 | 12 mm | 310     | 200     | 10     | 10/40 |
| YT-1576 | 13 mm | 310     | 200     | 10     | 10/40 |
| YT-1577 | 14 mm | 310     | 200     | 10     | 10/40 |
| YT-1578 | 15 mm | 310     | 200     | 10     | 10/40 |

GB Y-type socket wrench  
D Steckschlüssel vom Typ „Y”  
PL Klucz nasadowy typu „Y”  
RUS Торцовый ключ типа „Y”

CZ Klič nástrčný typ „Y”  
H „Y” típusú dugókulcs  
RO Cheie tubulară de tip „Y”  
E Llave tubular „Y”

CrV  
6140

AS-DRIVE

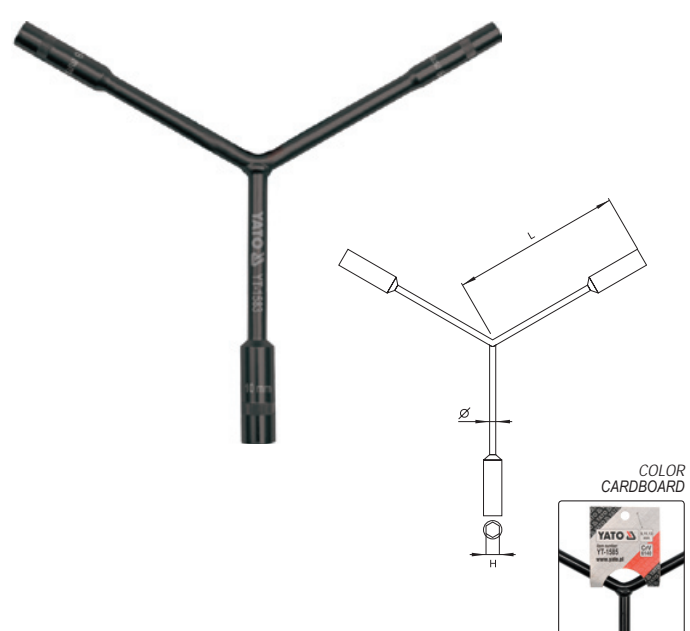

| YATO    | Ø H         | L (mm) | Ø (mm) |       |
|---------|-------------|--------|--------|-------|
| YT-1583 | 8-9-10 mm   | 140    | 10     | 10/40 |
| YT-1584 | 8-10-12 mm  | 140    | 10     | 10/40 |
| YT-1585 | 9-11-13 mm  | 140    | 10     | 10/40 |
| YT-1586 | 12-14-17 mm | 140    | 10     | 10/40 |

1

GB Adjustable wrench  
D Rollgabelschlüssel  
PL Klucz nastawny

RUS Ключ разводной  
CZ Nastavitelný klíč  
H Állítható svédkulcs

RO Cheie reglabilă  
E Llave ajustable  
tipo inglesa

150 mm 200 mm 250 mm 300 mm 375 mm



| YATO    | L (mm) |      |
|---------|--------|------|
| YT-2071 | 150    | 6/60 |
| YT-2072 | 200    | 6/60 |
| YT-2073 | 250    | 6/36 |
| YT-2074 | 300    | 6/24 |
| YT-2075 | 375    | 6/12 |

GB Adjustable wrench  
D Rollgabelschlüssel  
PL Klucz nastawny

RUS Ключ разводной  
CZ Nastavitelný klíč  
H Állítható svédkulcs

RO Cheie reglabilă  
E Llave ajustable  
tipo inglesa

150 mm 200 mm 250 mm 300 mm DIN 3117 CrV



| YATO    | L (mm) |       |
|---------|--------|-------|
| YT-2165 | 150    | 6/120 |
| YT-2166 | 200    | 6/60  |
| YT-2167 | 250    | 6/36  |
| YT-2168 | 300    | 6/24  |

GB Adjustable wrench  
D Rollgabelschlüssel  
PL Klucz nastawny

RUS Ключ разводной  
CZ Nastavitelný klíč  
H Állítható svédkulcs

RO Cheie reglabilă  
E Llave ajustable  
tipo inglesa

380 mm 460 mm 605 mm 780 mm



\* - product not for european market  
\* - produkt nieprzeznaczony na rynek europejski

| YATO     | L (mm) |      |
|----------|--------|------|
| YT-2176* | 380    | 4/16 |
| YT-2177* | 460    | 2/12 |
| YT-2178* | 605    | 6    |
| YT-2179* | 780    | 4    |

GB Adjustable wrench  
D Rollgabelschlüssel  
PL Klucz nastawny

RUS Ключ разводной  
CZ Nastavitelný klíč  
H Állítható svédkulcs

RO Cheie reglabilă  
E Llave ajustable  
tipo inglesa

150 mm 200 mm 250 mm 300 mm DIN 3117 CrV



| YATO    | L (mm) |      |
|---------|--------|------|
| YT-2170 | 150    | 6/72 |
| YT-2171 | 200    | 6/60 |
| YT-2172 | 250    | 6/48 |
| YT-2173 | 300    | 6/36 |

GB Adjustable wrench  
D Rollgabelschlüssel  
PL Klucz nastawny z rączką kompozytową

RUS Ключ разводной  
CZ Nastavitelný klíč  
H Állítható svédkulcs

RO Cheie reglabilă  
E Llave ajustable  
tipo inglesa

220 mm 300 mm 180 Nm 515 Nm CrV 6140 DIN 3117 COMPOSITE HANDLE



\* - product not for european market  
\* - produkt nieprzeznaczony na rynek europejski

| YATO     | L (mm) |      |
|----------|--------|------|
| YT-2174* | 220    | 6/60 |
| YT-2175* | 300    | 3/30 |



Memo

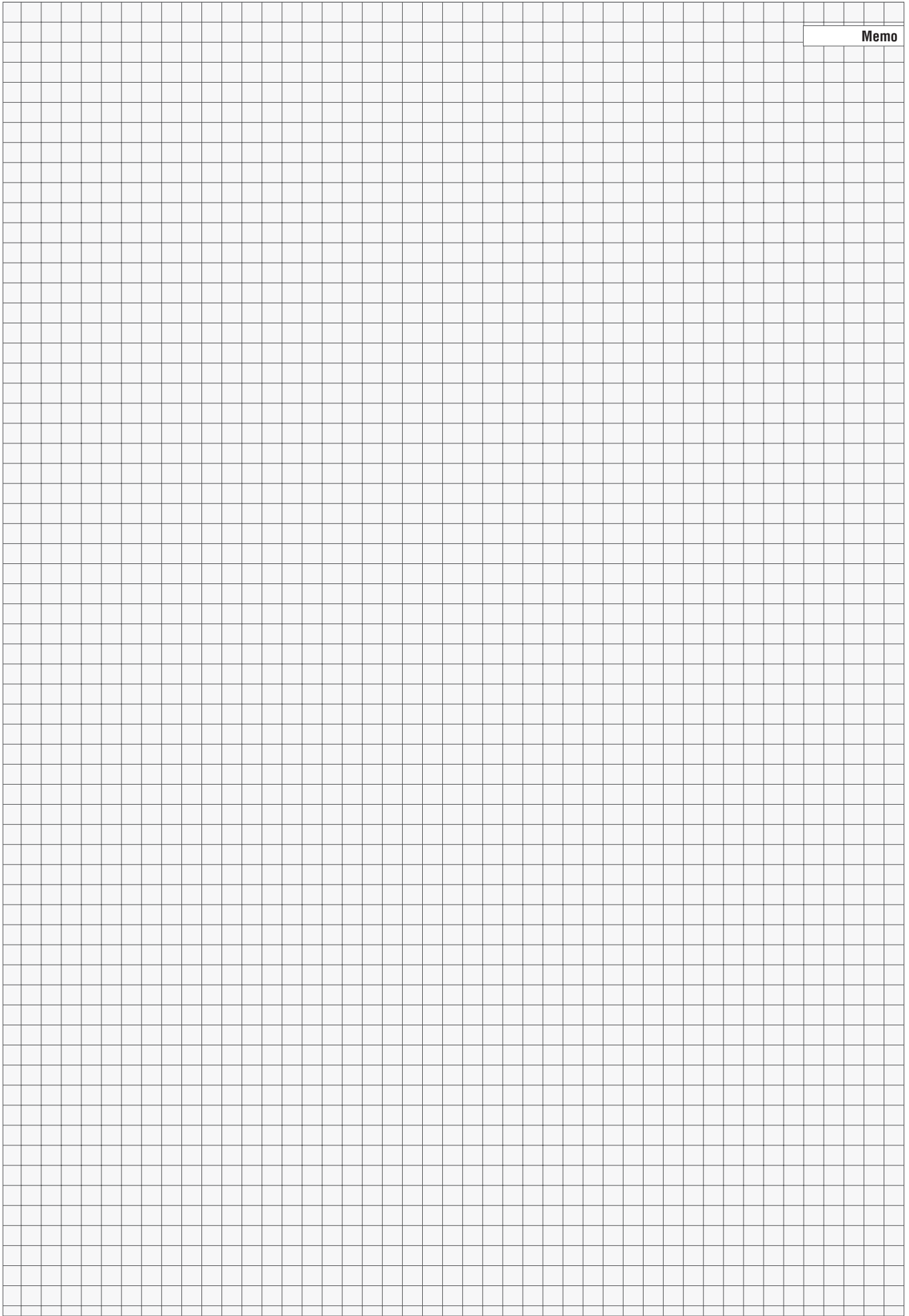

# 2

**Sockets, accessories & sets**  
**Klucze nasadowe,**  
**akcesoria i zestawy**

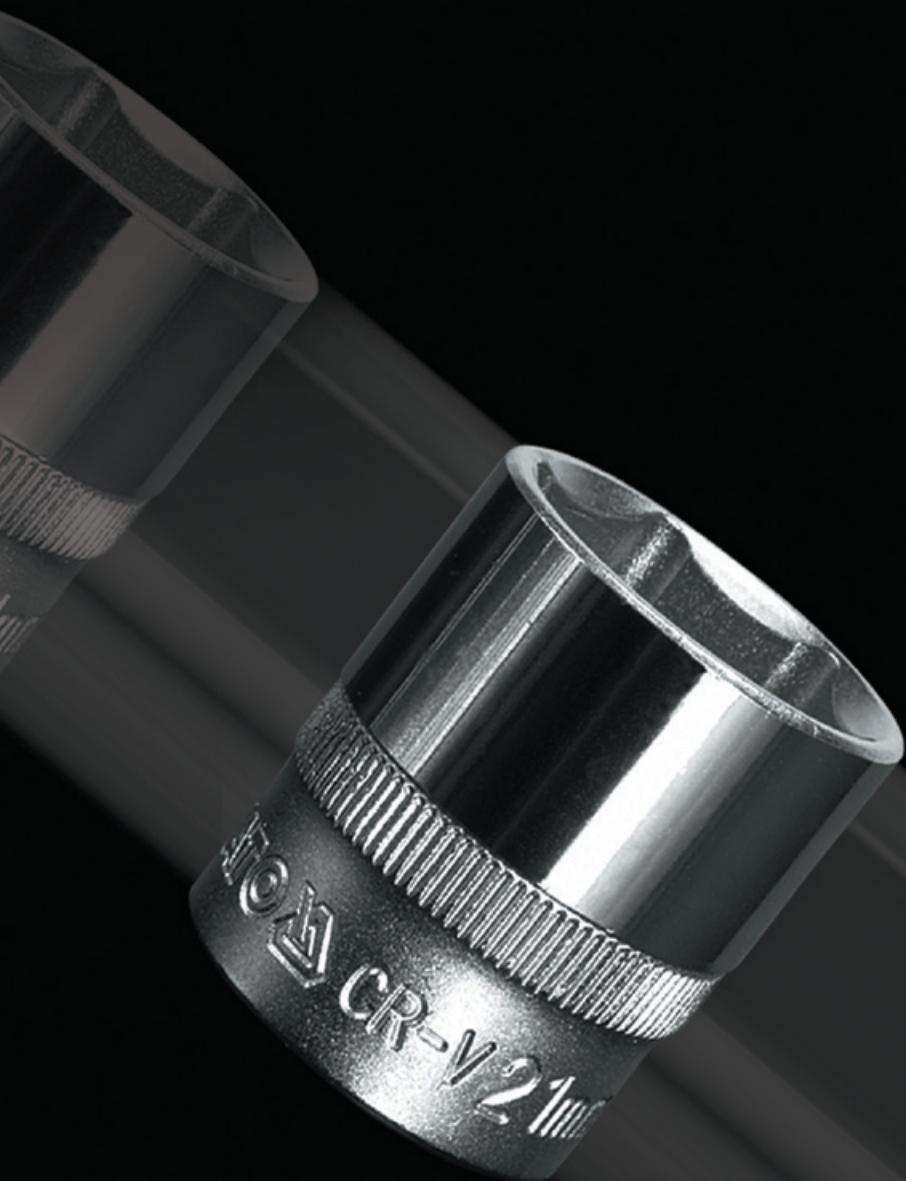

**Sockets 1/4"**  
Klucze nasadowe 1/4"

29 

**Hexagonal sockets**  
Klucze nasadowe sześciokątne, krótkie..... 29  
**Hexagonal sockets S.A.E.**  
Klucze nasadowe sześciokątne S.A.E., krótkie..... 29  
**Hexagonal deep sockets**  
Klucze nasadowe sześciokątne, długie..... 29  
**Hexagonal deep sockets S.A.E.**  
Klucze nasadowe sześciokątne S.A.E., długie..... 29

**Accessories 1/4"**  
Akcesoria 1/4"

30 

**Extension bars**  
Przedłużki..... 30  
**Extension bars with wobble**  
Przedłużki uchylnie..... 30  
**Flexible extension cords**  
Przedłużki elastyczne..... 30  
**Adapters**  
Redukcje..... 30  
**Bit adapters**  
Adaptory do bitów..... 30  
**Universal joints**  
Przeguby Cardana..... 30  
**Spinner handles**  
Pokręta do nasadek..... 30  
**Sliding T-bars**  
Pokręta typu „T”..... 30  
**Flexible handles**  
Pokręta łamane..... 30

**Ratchet handles 1/4"**  
Grzechotki 1/4"

31-32 

**Ratchet handles**  
Grzechotki..... 31  
**Flexible ratchet handles**  
Grzechotki z przegubem..... 31  
**Composite ratchet handles**  
Grzechotki powlekane..... 31  
**Curved ratchet handles**  
Grzechotki wygięte..... 31  
**Telescopic ratchet handles**  
Grzechotki z przedłużonym uchwytem..... 32  
**Bit and socket drive ratchet handles**  
Grzechotki do bitów i nasadek..... 32  
**Rotary head ratchet handles**  
Grzechotki z obrotową głowicą..... 32  
**Ratchet handles with traction belt**  
Grzechotki z paskiem transmisyjnym..... 32

**Sockets 3/8"**  
Klucze nasadowe 3/8"

33 

**Hexagonal sockets**  
Klucze nasadowe sześciokątne, krótkie..... 33  
**Hexagonal sockets S.A.E.**  
Klucze nasadowe sześciokątne S.A.E., krótkie..... 33  
**Hexagonal deep sockets**  
Klucze nasadowe sześciokątne, długie..... 33  
**Hexagonal deep sockets S.A.E.**  
Klucze nasadowe sześciokątne S.A.E., długie..... 33

**Accessories 3/8"**  
Akcesoria 3/8"

34 

**Extension bars**  
Przedłużki..... 34  
**Extension bars with wobble**  
Przedłużki uchylnie..... 34  
**Adapters**  
Redukcje..... 34  
**Bit adapters**  
Adaptory do bitów..... 34  
**Universal joints**  
Przeguby Cardana..... 34  
**Sliding T-bars**  
Pokręta typu „T”..... 34  
**Flexible handles**  
Pokręta łamane..... 34  
**Spark plug sockets**  
Klucze nasadowe do świec..... 34

**Ratchet handles 3/8"**  
Grzechotki 3/8"

35-36 

**Ratchet handles**  
Grzechotki..... 35  
**Flexible ratchet handles**  
Grzechotki z przegubem..... 35  
**Composite ratchet handles**  
Grzechotki powlekane..... 35  
**Curved ratchet handles**  
Grzechotki wygięte..... 35  
**Telescopic ratchet handles**  
Grzechotki z przedłużonym uchwytem..... 36  
**Rotary head ratchet handles**  
Grzechotki z obrotową głowicą..... 36  
**Ratchet handles with traction belt**  
Grzechotki z paskiem transmisyjnym..... 36

**Sockets 1/2"**  
Klucze nasadowe 1/2"

37-38 









**Hexagonal sockets**  
Klucze nasadowe sześciokątne, krótkie..... 37  
**Hexagonal sockets S.A.E.**  
Klucze nasadowe sześciokątne S.A.E., krótkie..... 37  
**Bi-hexagonal sockets**  
Klucze nasadowe dwunastokątne, krótkie..... 37  
**Spline sockets**  
Klucze nasadowe „Spline”..... 37  
**Hexagonal deep sockets**  
Klucze nasadowe sześciokątne, długie..... 38  
**Hexagonal deep sockets S.A.E.**  
Klucze nasadowe sześciokątne S.A.E., długie..... 38

**Accessories 1/2"**  
Akcesoria 1/2"

38-39 

**Extension bars**  
Przedłużki..... 38  
**Extension bars with wobble**  
Przedłużki uchylnie..... 38  
**Adapters**  
Redukcje..... 39  
**Bit adapters**  
Adaptory do bitów..... 39



|   |       |   |       |   |
|---|-------|---|-------|---|
| Universal joints<br>Przeguby Cardana.....                                       | 39    | Torx socket sets 1/2", 1/4"<br>Zestawy kluczy nasadowych „Torx” 1/2”, 1/4”.....           | 64    |    |
| Sliding T-bars<br>Pokręta typu „T”.....   | 39    | Go-trough socket sets 1/2"<br>Zestawy kluczy nasadowych, przelotowych 1/2”.....           | 64    |    |
| Flexible handles<br>Pokręta łamane.....   | 39    | Sockets 3/4"<br>Klucze nasadowe 3/4”.....   | 64    |    |
| L-type handles<br>Pokręta typu „L”.....   | 39    | Accessories 3/4"<br>Akcesoria 3/4”.....   | 65    |    |
| Spark plug sockets<br>Klucze nasadowe do świec.....                             | 39    | Extension bars<br>Przedłużki.....   | 65    |   |
| Ratchet handles 1/2"<br>Grzechotki 1/2”.....                                    | 40-41 | Adapters<br>Redukcje.....   | 65    |   |
| Ratchet handles<br>Grzechotki.....  | 40    | Universal joints<br>Przeguby Cardana.....   | 65    |   |
| Flexible ratchet handles<br>Grzechotki z przegubem.....                         | 40    | Sliding T-bars<br>Pokręta typu „T”.....   | 65    |   |
| Composite ratchet handles<br>Grzechotki powlekane.....                          | 40    | Flexible handles<br>Pokręta łamane.....   | 65    |   |
| Curved ratchet handles<br>Grzechotki wygięte.....                               | 40    | L-type handles<br>Pokręta typu „L”.....   | 65    |   |
| Telescopic ratchet handles<br>Grzechotki z przedłużonym uchwytem.....           | 41    | Ratchet handles 3/4"<br>Grzechotki 3/4”.....  | 66    |  |
| Ratchet handles with extension<br>Grzechotki z przedłużką.....                  | 41    | Socket sets 3/4"<br>Zestawy kluczy nasadowych 3/4”.....                                   | 66    |  |
| Rotary head ratchet handles<br>Grzechotki z obrotową głowicą.....               | 41    | Bit sockets & sets 1/4", 3/8", 1/2"<br>Klucze trzpieniowe i zestawy 1/4”, 3/8”, 1/2”..... | 67-69 |  |
| Ratchet handles with traction belt<br>Grzechotki z paskiem transmisyjnym.....   | 41    | Tool sets<br>Zestawy narzędziowe.....   | 62-63 |    |
| Socket sets<br>Zestawy kluczy nasadowych.....                                   | 42-61 |   |       |   |
| Socket sets 1/4"<br>Zestawy kluczy nasadowych 1/4”.....                         | 42    |   |       |   |
| Socket sets 3/8"<br>Zestawy kluczy nasadowych 3/8”.....                         | 46    |   |       |   |
| Socket sets 1/2"<br>Zestawy kluczy nasadowych 1/2”.....                         | 48    |   |       |   |
| Socket sets 1/2", 1/4"<br>Zestawy kluczy nasadowych 1/2”, 1/4”.....             | 54    |   |       |   |
| Socket sets 1/2", 3/8", 1/4"<br>Zestawy kluczy nasadowych 1/2”, 3/8”, 1/4”..... | 58    |   |       |   |

GB Hexagonal socket  
D Sechskantenschlüssel  
PL Nasadka sześciokątna  
RUS Головка шестигранная короткая  
CZ Šestihřanný nástavec  
H Hatszögű rátét  
RO Cheie tubulară hexagonală  
E Boquilla hexagonal corta

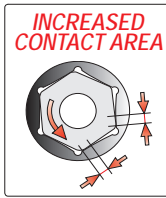

1/4" DIN 3121  
6.3 mm CrV 50BV30  
AS-DRIVE

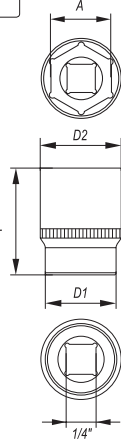

- drive locks
- surface finish: chromed, satin / mirror
- zamki blokujące
- wykończenie powierzchni: chromowana, satynowa / polerowana

| YATO    | ∅ A (mm) | D1 (mm) | D2 (mm) | L (mm) | PCS packing |         |
|---------|----------|---------|---------|--------|-------------|---------|
| YT-1401 | 4.0      | 7.0     | 12.0    | 25     | 20          | 200/400 |
| YT-1402 | 4.5      | 7.5     | 12.0    | 25     | 20          | 200/400 |
| YT-1403 | 5.0      | 8.0     | 12.0    | 25     | 20          | 200/400 |
| YT-1404 | 5.5      | 8.5     | 12.0    | 25     | 20          | 200/400 |
| YT-1405 | 6.0      | 9.0     | 12.0    | 25     | 20          | 200/400 |
| YT-1406 | 7.0      | 10.0    | 12.0    | 25     | 20          | 200/400 |
| YT-1407 | 8.0      | 12.0    | 11.0    | 25     | 20          | 200/400 |
| YT-1408 | 9.0      | 13.0    | 12.0    | 25     | 20          | 200/400 |
| YT-1409 | 10.0     | 15.0    | 12.0    | 25     | 10          | 200/400 |
| YT-1410 | 11.0     | 16.0    | 14.0    | 25     | 10          | 200/400 |
| YT-1411 | 12.0     | 17.0    | 15.0    | 25     | 10          | 200/400 |
| YT-1412 | 13.0     | 18.0    | 16.0    | 25     | 10          | 200/400 |

GB Hexagonal socket  
D Sechskantenschlüssel  
PL Nasadka sześciokątna  
RUS Головка шестигранная короткая  
CZ Šestihřanný nástavec  
H Hatszögű rátét  
RO Cheie tubulară hexagonală  
E Boquilla hexagonal corta

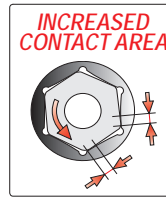

1/4" DIN 3121  
6.3 mm CrV 50BV30  
AS-DRIVE S.A.E.

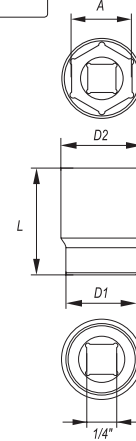

- drive locks
- surface finish: chromed, mirror
- zamki blokujące
- wykończenie powierzchni: chromowana, polerowana

| YATO     | ∅ A             | D1 (mm) | D2 (mm) | L (mm) | PCS packing |         |
|----------|-----------------|---------|---------|--------|-------------|---------|
| YT-5040* | 5/32" (4.0 mm)  | 7.0     | 12.0    | 25     | 10          | 200/400 |
| YT-5041* | 3/16" (4.8 mm)  | 8.0     | 12.0    | 25     | 10          | 200/400 |
| YT-5042* | 7/32" (5.6 mm)  | 9.0     | 12.0    | 25     | 10          | 200/400 |
| YT-5043* | 1/4" (6.3 mm)   | 10.0    | 12.0    | 25     | 10          | 200/400 |
| YT-5044* | 9/32" (7.1 mm)  | 11.0    | 12.0    | 25     | 10          | 200/400 |
| YT-5045* | 5/16" (7.9 mm)  | 12.0    | 11.1    | 25     | 10          | 200/400 |
| YT-5046* | 11/32" (8.7 mm) | 13.0    | 11.5    | 25     | 10          | 200/400 |
| YT-5047* | 3/8" (9.5 mm)   | 14.7    | 12.3    | 25     | 10          | 200/400 |
| YT-5048* | 7/16" (11.1 mm) | 16.0    | 13.9    | 25     | 10          | 200/400 |
| YT-5049* | 1/2" (12.7 mm)  | 18.0    | 15.7    | 25     | 10          | 200/400 |

\* - product not for european market  
\* - produkt nieprzeznaczony na rynek europejski

GB Hexagonal deep socket  
D Sechskantenschlüssel, lange  
PL Nasadka sześciokątna długa  
RUS Головка шестигранная длинная  
CZ Šestihřanný hluboký nástavec  
H Hatszögű rátét mély  
RO Cheie tubulară hexagonală adâncă  
E Boquilla hexagonal larga

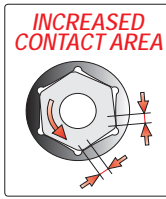

1/4" DIN 3121  
6.3 mm CrV 50BV30  
AS-DRIVE

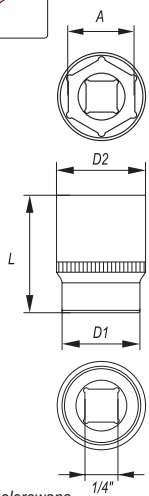

- drive locks
- surface finish: chromed, satin / mirror
- zamki blokujące
- wykończenie powierzchni: chromowana, satynowa / polerowana

| YATO    | ∅ A (mm) | D1 (mm) | D2 (mm) | L (mm) | PCS packing |         |
|---------|----------|---------|---------|--------|-------------|---------|
| YT-1413 | 4.0      | 7.0     | 12.0    | 50     | 10          | 200/400 |
| YT-1414 | 4.5      | 7.5     | 12.0    | 50     | 10          | 200/400 |
| YT-1415 | 5.0      | 8.0     | 12.0    | 50     | 10          | 200/400 |
| YT-1416 | 5.5      | 8.5     | 12.0    | 50     | 10          | 200/400 |
| YT-1417 | 6.0      | 9.0     | 12.0    | 50     | 10          | 200/400 |
| YT-1418 | 7.0      | 10.0    | 12.0    | 50     | 10          | 200/400 |
| YT-1419 | 8.0      | 12.0    | 12.0    | 50     | 10          | 200/400 |
| YT-1420 | 9.0      | 13.0    | 12.0    | 50     | 10          | 200/400 |
| YT-1421 | 10.0     | 14.0    | 13.0    | 50     | 10          | 200/400 |
| YT-1422 | 11.0     | 16.0    | 14.0    | 50     | 10          | 100/200 |
| YT-1423 | 12.0     | 17.0    | 15.0    | 50     | 10          | 100/200 |
| YT-1424 | 13.0     | 18.0    | 16.0    | 50     | 10          | 100/200 |

GB Hexagonal deep socket  
D Sechskantenschlüssel, lange  
PL Nasadka sześciokątna długa  
RUS Головка шестигранная длинная  
CZ Šestihřanný hluboký nástavec  
H Hatszögű rátét mély  
RO Cheie tubulară hexagonală adâncă  
E Boquilla hexagonal larga

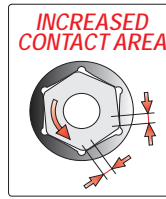

1/4" DIN 3121  
6.3 mm CrV 50BV30  
AS-DRIVE S.A.E.

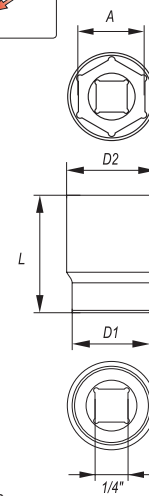

- drive locks
- surface finish: chromed, mirror
- zamki blokujące
- wykończenie powierzchni: chromowana, polerowana

| YATO     | ∅ A             | D1 (mm) | D2 (mm) | L (mm) | PCS packing |         |
|----------|-----------------|---------|---------|--------|-------------|---------|
| YT-5050* | 3/16" (4.8 mm)  | 8.0     | 12.0    | 50     | 10          | 200/400 |
| YT-5051* | 7/32" (5.6 mm)  | 9.0     | 12.0    | 50     | 10          | 200/400 |
| YT-5052* | 1/4" (6.3 mm)   | 10.0    | 12.0    | 50     | 10          | 200/400 |
| YT-5053* | 9/32" (7.1 mm)  | 11.0    | 12.0    | 50     | 10          | 200/400 |
| YT-5054* | 5/16" (7.9 mm)  | 12.0    | 11.1    | 50     | 10          | 200/400 |
| YT-5055* | 11/32" (8.7 mm) | 13.0    | 11.5    | 50     | 10          | 200/400 |
| YT-5056* | 3/8" (9.5 mm)   | 14.6    | 12.3    | 50     | 10          | 200/400 |
| YT-5057* | 7/16" (11.1 mm) | 16.0    | 13.9    | 50     | 10          | 100/200 |
| YT-5058* | 1/2" (12.7 mm)  | 18.0    | 15.7    | 50     | 10          | 100/200 |

\* - product not for european market  
\* - produkt nieprzeznaczony na rynek europejski

GB Extension bar  
D Verlängerung  
PL Przedłużka  
RUS Удлинитель для воротка  
CZ Prodlužovací přípravek  
H Toldalék  
RO Prelungitor  
E Tubo de prolongación

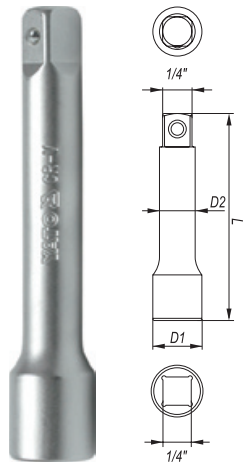

1/4" DIN 3121  
6.3 mm CrV 50BV30

COLOR BOX



| YATO    | Ø             | D1 (mm) | D2 (mm) | L (mm) | PCS packing: | Box     |
|---------|---------------|---------|---------|--------|--------------|---------|
| YT-1429 | 1/4" (6.3 mm) | 12.4    | 8.3     | 50.8   | 30           | 150/300 |
| YT-1430 | 1/4" (6.3 mm) | 12.4    | 8.3     | 76.0   | 30           | 150/300 |
| YT-1431 | 1/4" (6.3 mm) | 12.4    | 8.3     | 101.6  | 20           | 100/200 |
| YT-1432 | 1/4" (6.3 mm) | 12.4    | 8.3     | 152.4  | 20           | 100/200 |

GB Extension bar with wobble  
D Gelenkverlängerung  
PL Przedłużka uchylna  
RUS Удлинитель наклонный  
CZ Odchylný prodlužovací přípravek  
H Csuklós toldalék  
RO Prelungitor rabatabil  
E Tubo de prolongación desviable

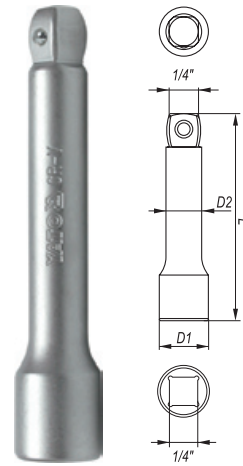

1/4" DIN 3121  
6.3 mm CrV 50BV30

COLOR BOX



| YATO    | Ø             | D1 (mm) | D2 (mm) | L (mm) | PCS packing: | Box     |
|---------|---------------|---------|---------|--------|--------------|---------|
| YT-1433 | 1/4" (6.3 mm) | 12.4    | 8.3     | 50.8   | 30           | 150/300 |
| YT-1434 | 1/4" (6.3 mm) | 12.4    | 8.3     | 76.0   | 30           | 150/300 |
| YT-1435 | 1/4" (6.3 mm) | 12.4    | 8.3     | 101.6  | 20           | 100/200 |
| YT-1436 | 1/4" (6.3 mm) | 12.4    | 8.3     | 152.4  | 20           | 100/200 |

GB Extension bar  
D Verlängerung  
PL Przedłużka elastyczna  
RUS Удлинитель для воротка  
CZ Prodlužovací přípravek  
H Toldalék  
RO Prelungitor  
E Tubo de prolongación

1/4" 6.3 mm CrV 6140



COLOR BOX

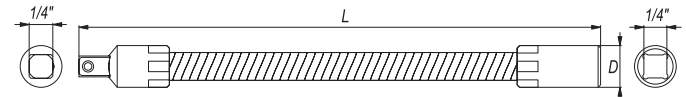

| YATO    | Ø             | Ø             | D (mm) | L (mm) | PCS packing: | Box     |
|---------|---------------|---------------|--------|--------|--------------|---------|
| YT-1400 | 1/4" (6.3 mm) | 1/4" (6.3 mm) | 11.6   | 150    | 25           | 250/500 |

GB Adapter  
D Reduktion  
PL Redukcja  
RUS Переходник  
CZ Redukce  
H Redukció  
RO Reducție  
E Reducció

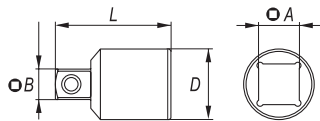

1/4" 6.3 mm DIN 3121 CrV 50BV30

COLOR BOX



| YATO    | Ø A               | Ø B               | D (mm) | L (mm) | PCS packing: | Box     |
|---------|-------------------|-------------------|--------|--------|--------------|---------|
| YT-1438 | 1/4" (6.3 mm) (F) | 3/8" (9.5 mm) (M) | 12     | 25     | 10           | 250/500 |

GB Bit adapter  
D Bithalter  
PL Adapter do bitów  
RUS Держатель винтовёртовых наконечников  
CZ Držák na šroubovakové koncovky  
H Szár a csavarhúzóvégkehez  
RO Capete şurubelniță  
E Mandril para puntas

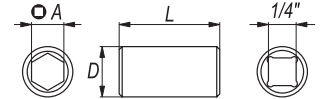

1/4" 6.3 mm CrV 6140

COLOR BOX



| YATO    | Ø             | Ø A           | D (mm) | L (mm) | PCS packing: | Box     |
|---------|---------------|---------------|--------|--------|--------------|---------|
| YT-1297 | 1/4" (6.3 mm) | 1/4" (6.3 mm) | 11.8   | 24     | 10           | 250/500 |

GB Universal joint  
D Kardangelen  
PL Przegub Cardana  
RUS Карданный шарнир  
CZ Kardanový kloub  
H Kardán csukló  
RO Articulație Cardanică  
E Articulación Cardan

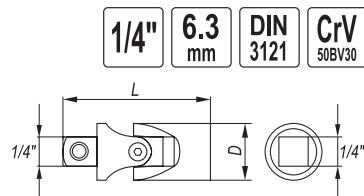

1/4" 6.3 mm DIN 3121 CrV 50BV30



COLOR BOX

| YATO    | Ø             | D (mm) | L (mm) | PCS packing: | Box     |
|---------|---------------|--------|--------|--------------|---------|
| YT-1437 | 1/4" (6.3 mm) | 14     | 35     | 20           | 120/240 |

GB Sliding T-bar  
D Handgriff mit Gleitstück  
PL Pokrętko typu „T”  
RUS Вороток T-образный  
CZ Otočná račka typ „T”  
H „T” alakú hajtókar  
RO Mâner clupă tipul „T”  
E Mango tipo „T”

1/4" 6.3 mm DIN 3121 CrV 50BV30

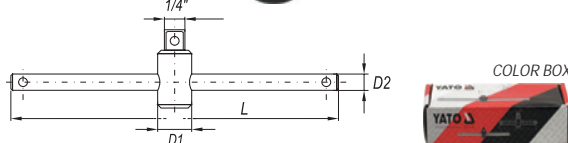

COLOR BOX



| YATO    | Ø             | D1 (mm) | D2 (mm) | L (mm) | PCS packing: | Box     |
|---------|---------------|---------|---------|--------|--------------|---------|
| YT-1426 | 1/4" (6.3 mm) | 13.3    | 6.3     | 152.4  | 10           | 100/200 |

GB Flexible handle  
D Gelenkgriff  
PL Pokrętko lamane  
RUS Вороток шарнирный  
CZ Otočná lomená račka  
H Hajlított hajtókar  
RO Prelungitor cu prindere flexibilă  
E Mango articulado

1/4" 6.3 mm DIN 3121 CrV 50BV30

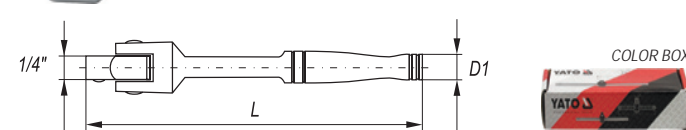

COLOR BOX



| YATO    | Ø             | D (mm) | L (mm) | PCS packing: | Box     |
|---------|---------------|--------|--------|--------------|---------|
| YT-1425 | 1/4" (6.3 mm) | 13     | 140    | 10           | 100/200 |

GB Quick release ratchet handle  
D Hebelumschaltknarre  
PL Grzechotka  
RUS Трещотка

CZ Řehtačka  
H Racsnis hajtókar  
RO Dispozitiv de prindere cu clichet  
E Carraca

PLASTIC HANGER



12 PCS



COLOR BOX

1/4" DIN 3122 QUICK RELEASE SZYBKO-ZŁĄCZE  
6.3 mm 72T CrV 6140



| YATO    | Ø             | T  | L (mm) | PCS packing | Box   |
|---------|---------------|----|--------|-------------|-------|
| YT-0307 | 1/4" (6.3 mm) | 72 | 146    | 12          | 24/96 |

| YATO    | Ø             | T  | L (mm) | PCS packing | Box   |
|---------|---------------|----|--------|-------------|-------|
| YT-0310 | 1/4" (6.3 mm) | 72 | 125    | 12          | 36/72 |

| YATO    | Ø             | T  | L (mm) | PCS packing | Box   |
|---------|---------------|----|--------|-------------|-------|
| YT-0313 | 1/4" (6.3 mm) | 72 | 125    | 12          | 24/96 |



| YATO    | Ø             | T  | L (mm) | PCS packing | Box   |
|---------|---------------|----|--------|-------------|-------|
| YT-0316 | 1/4" (6.3 mm) | 72 | 145    | 12          | 24/96 |

| YATO    | Ø             | T  | L (mm) | PCS packing | Box   |
|---------|---------------|----|--------|-------------|-------|
| YT-0319 | 1/4" (6.3 mm) | 72 | 145    | 12          | 48/96 |

| YATO    | Ø             | T  | L (mm) | PCS packing | Box   |
|---------|---------------|----|--------|-------------|-------|
| YT-0322 | 1/4" (6.3 mm) | 72 | 148    | 12          | 48/96 |

GB Quick release ratchet handle H Racsnis hajtókar  
D Hebelumschaltknarre RO Dispozitiv de prindere cu clichet  
PL Grzechotka  
RUS Трещотка с шарниром E Carraca  
CZ Řehtačka

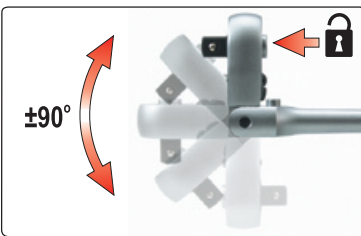

PLASTIC HANGER



12 PCS



COLOR BOX

1/4" QUICK RELEASE SZYBKO-ZŁĄCZE DIN 3122  
6.3 mm 72T CrV 6140

| YATO    | Ø             | T  | L (mm) | PCS packing | Box   |
|---------|---------------|----|--------|-------------|-------|
| YT-0325 | 1/4" (6.3 mm) | 72 | 159    | 12          | 48/96 |

GB Quick release ratchet handle  
D Hebelumschaltknarre  
PL Grzechotka powlekana  
RUS Трещотка  
CZ Řehtačka  
H Racsnis hajtókar  
RO Dispozitiv de prindere cu clichet  
E Carraca

PLASTIC HANGER



12 PCS



1/4" DIN 3122  
6.3 mm QUICK RELEASE SZYBKO-ZŁĄCZE  
72T CrV 6135



| YATO    | Ø             | T  | L (mm) | PCS packing | Box   |
|---------|---------------|----|--------|-------------|-------|
| YT-0290 | 1/4" (6.3 mm) | 72 | 144    | 12          | 48/96 |



| YATO    | Ø             | T  | L (mm) | PCS packing | Box   |
|---------|---------------|----|--------|-------------|-------|
| YT-0293 | 1/4" (6.3 mm) | 72 | 144    | 12          | 48/96 |

GB Quick release ratchet handle  
D Hebelumschaltknarre  
PL Grzechotka  
RUS Трещотка с шарниром  
CZ Řehtačka  
H Racsnis hajtókar  
RO Dispozitiv de prindere cu clichet  
E Carraca

PLASTIC HANGER



12 PCS



1/4" 72T  
6.3 mm QUICK RELEASE SZYBKO-ZŁĄCZE  
CrV 6140



| YATO    | Ø             | T  | L (mm) | PCS packing | Box   |
|---------|---------------|----|--------|-------------|-------|
| YT-0730 | 1/4" (6.3 mm) | 72 | 155    | 12          | 24/96 |

GB Quick release ratchet handle  
 D Hebelumschaltknarre  
 PL Grzechotka  
 RUS Трещотка с шарниром  
 CZ Řehtačka  
 H Racsnis hajtókar  
 RO Dispozitiv de prindere cu clichet  
 E Carraca

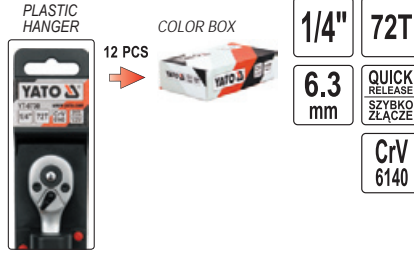

1/4" 72T  
 6.3 mm QUICK RELEASE SZYBKO-ZŁĄCZE  
 CrV 6140



| YATO     | Ø             | T  | L (mm) | PCS packing | Box   |
|----------|---------------|----|--------|-------------|-------|
| YT-07291 | 1/4" (6.3 mm) | 72 | 155    | 12          | 24/96 |

GB Quick release ratchet handle  
 D Hebelumschaltknarre  
 PL Grzechotka  
 RUS Трещотка с шарниром  
 CZ Řehtačka  
 H Racsnis hajtókar  
 RO Dispozitiv de prindere cu clichet  
 E Carraca

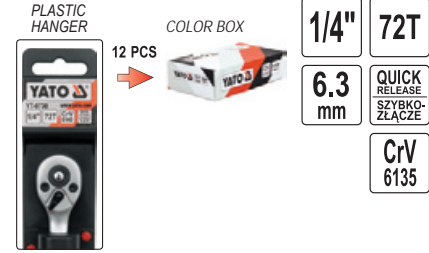

1/4" 72T  
 6.3 mm QUICK RELEASE SZYBKO-ZŁĄCZE  
 CrV 6135



| YATO    | Ø             | T  | L (mm) | PCS packing | Box   |
|---------|---------------|----|--------|-------------|-------|
| YT-0733 | 1/4" (6.3 mm) | 72 | 155    | 12          | 24/96 |

GB Telescopic ratchet handle  
 D Umschaltknarre  
 PL Grzechotka z przedłużanym uchwytem  
 RUS Трещотка  
 CZ Řehtačka  
 H Racsnis hajtókar  
 RO Antrenor cu clichet  
 E Carraca telescópico

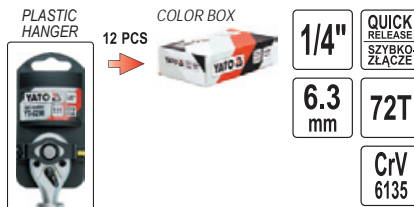

1/4" QUICK RELEASE SZYBKO-ZŁĄCZE  
 6.3 mm 72T  
 CrV 6135



| YATO    | Ø             | T  | L (mm)  | PCS packing | Box |
|---------|---------------|----|---------|-------------|-----|
| YT-0297 | 1/4" (6.3 mm) | 72 | 150-200 | 12          | 48  |

GB Ratchet handle and bit drive  
 D Bit- und Steckschlüssel-Umschaltknarre  
 PL Grzechotka do bitów i nasadek  
 RUS Трещотка для битов и головок  
 CZ Ráčna kombinovaná pro bity a nástrčné kľíče  
 H Bit és dugófej behajtó racsnis hajtókar  
 RO Antrenor cu clichet / antrenor pt. biti  
 E Carraca para boquillas y puntas

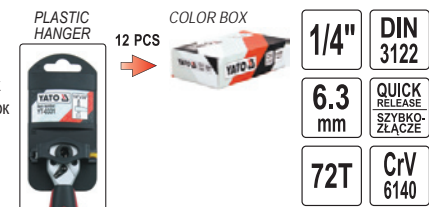

1/4" DIN 3122  
 6.3 mm QUICK RELEASE SZYBKO-ZŁĄCZE  
 72T CrV 6140



| YATO    | Ø             | T  | L (mm) | PCS packing | Box |
|---------|---------------|----|--------|-------------|-----|
| YT-0331 | 1/4" (6.3 mm) | 72 | 136    | 12          | 48  |

GB Flexible ratchet handle / round head  
 D Flexible Drehkopfratsche  
 PL Grzechotka z obrotową głowicą  
 RUS Трещотка с вращательной головкой  
 CZ Ráčna s otočnou hlavou  
 H Forgófejes racsnis szár  
 RO Antrenor cu clichet flexibil  
 E Carraca con cabeza giratoria

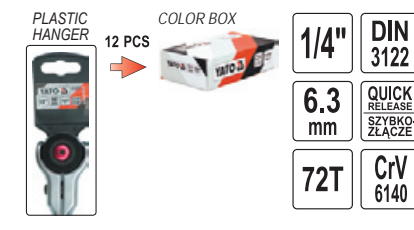

1/4" DIN 3122  
 6.3 mm QUICK RELEASE SZYBKO-ZŁĄCZE  
 72T CrV 6140



| YATO    | Ø             | T  | L (mm) | PCS packing | Box   |
|---------|---------------|----|--------|-------------|-------|
| YT-0720 | 1/4" (6.3 mm) | 72 | 145    | 12          | 24/96 |

GB Ratchet handle with traction belt  
 D Ratsche mit Drehantriebsrad  
 PL Grzechotka z paskiem transmisyjnym  
 RUS Трещотка реверсионная  
 CZ Ráčna s násobičom  
 H Racsnis szár szíjhajtással  
 RO Antrenor cu clichet cu tractiune pe curea  
 E Carraca con cinta de transmisión

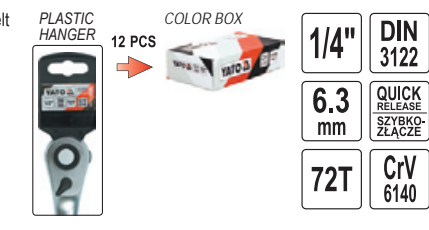

1/4" DIN 3122  
 6.3 mm QUICK RELEASE SZYBKO-ZŁĄCZE  
 72T CrV 6140



| YATO    | Ø             | T  | L (mm) | PCS packing | Box   |
|---------|---------------|----|--------|-------------|-------|
| YT-0723 | 1/4" (6.3 mm) | 72 | 145    | 12          | 24/96 |



GB Hexagonal socket  
 D Sechskantenschlüssel  
 PL Nasadka sześciokątna  
 RUS Головка шестигранная короткая  
 CZ Šestihřanný nástavec  
 H Hatszögű rátét  
 RO Cheie tubulară hexagonală  
 E Boquilla hexagonal corta

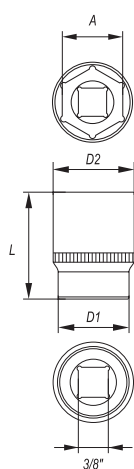

3/8" DIN 3121  
 10 mm CrV 50BV30  
 AS-DRIVE

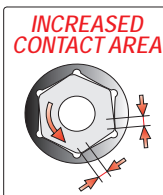

COLOR BOX

\* - product not for european market  
 \* - produkt nieprzeznaczony na rynek europejski

- drive locks
- surface finish: chromed, satin / mirror
- zamki blokujące
- wykończenie powierzchni: chromowana, satynowa / polerowana

| YATO     | ∅ A (mm) | D1 (mm) | D2 (mm) | L (mm) | PCS packing: |         |
|----------|----------|---------|---------|--------|--------------|---------|
| YT-3801  | 6        | 10      | 17      | 28     | 10           | 250/500 |
| YT-3802  | 7        | 11      | 17      | 28     | 10           | 250/500 |
| YT-3803  | 8        | 12      | 17      | 28     | 10           | 250/500 |
| YT-3804  | 9        | 13      | 17      | 28     | 10           | 250/500 |
| YT-3805  | 10       | 14      | 17      | 28     | 10           | 250/500 |
| YT-3806  | 11       | 16      | 17      | 28     | 10           | 250/500 |
| YT-3807  | 12       | 18      | 17      | 28     | 10           | 250/500 |
| YT-3808  | 13       | 19      | 18      | 28     | 10           | 150/300 |
| YT-3809  | 14       | 20      | 19      | 28     | 10           | 150/300 |
| YT-3810  | 15       | 21      | 19      | 28     | 10           | 100/500 |
| YT-3811  | 16       | 22      | 21      | 28     | 10           | 100/500 |
| YT-3812  | 17       | 24      | 22      | 30     | 10           | 100/200 |
| YT-3813  | 18       | 25      | 23      | 30     | 10           | 100/200 |
| YT-3814  | 19       | 26      | 24      | 30     | 10           | 100/200 |
| YT-3815* | 20       | 27      | 25      | 30     | 10           | 50/150  |
| YT-3816* | 21       | 28      | 26      | 30     | 10           | 50/150  |
| YT-3817* | 22       | 30      | 28      | 30     | 10           | 50/150  |
| YT-3818* | 23       | 31      | 29      | 30     | 10           | 50/150  |
| YT-3819* | 24       | 32      | 30      | 30     | 10           | 50/150  |

GB Hexagonal socket  
 D Sechskantenschlüssel  
 PL Nasadka sześciokątna  
 RUS Головка шестигранная короткая  
 CZ Šestihřanný nástavec  
 H Hatszögű rátét  
 RO Cheie tubulară hexagonală  
 E Boquilla hexagonal corta

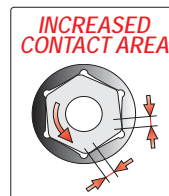

3/8" DIN 3121  
 10 mm CrV 50BV30  
 AS-DRIVE S.A.E.

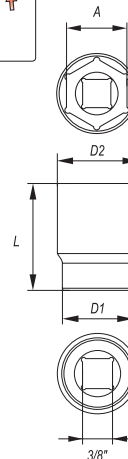

COLOR BOX

- drive locks
- surface finish: chromed, mirror
- zamki blokujące
- wykończenie powierzchni: chromowana, polerowana

| YATO     | ∅ A              | D1 (mm) | D2 (mm) | L (mm) | PCS packing: |         |
|----------|------------------|---------|---------|--------|--------------|---------|
| YT-5059* | 1/4" (6.3 mm)    | 17.0    | 10.0    | 28     | 10           | 250/500 |
| YT-5060* | 5/16" (7.9 mm)   | 17.0    | 11.7    | 28     | 10           | 250/500 |
| YT-5061* | 3/8" (9.5 mm)    | 17.0    | 14.2    | 28     | 10           | 250/500 |
| YT-5062* | 7/16" (11.1 mm)  | 17.0    | 16.3    | 28     | 10           | 250/500 |
| YT-5063* | 1/2" (12.7 mm)   | 17.0    | 18.0    | 28     | 10           | 150/300 |
| YT-5064* | 9/16" (14.3 mm)  | 18.0    | 20.0    | 28     | 10           | 100/500 |
| YT-5065* | 5/8" (15.9 mm)   | 19.0    | 22.0    | 28     | 10           | 100/500 |
| YT-5066* | 11/16" (17.5 mm) | 19.0    | 24.0    | 30     | 10           | 100/200 |
| YT-5067* | 3/4" (19.0 mm)   | 21.0    | 26.0    | 30     | 10           | 100/200 |
| YT-5068* | 13/16" (20.6 mm) | 23.0    | 28.0    | 30     | 10           | 100/200 |
| YT-5069* | 7/8" (22.2 mm)   | 24.0    | 30.0    | 32     | 10           | 100/200 |

\* - product not for european market  
 \* - produkt nieprzeznaczony na rynek europejski

GB Hexagonal deep socket  
 D Sechskantenschlüssel, lange  
 PL Nasadka sześciokątna długa  
 RUS Головка шестигранная длинная  
 CZ Šestihřanný hluboký nástavec  
 H Hatszögű rátét mély  
 RO Cheie tubulară hexagonală adâncă  
 E Boquilla hexagonal larga

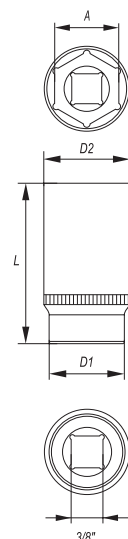

3/8" DIN 3121  
 10 mm CrV 50BV30  
 AS-DRIVE

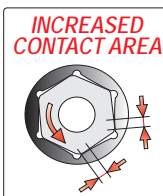

COLOR BOX

\* - product not for european market  
 \* - produkt nieprzeznaczony na rynek europejski

- drive locks
- surface finish: chromed, satin / mirror
- zamki blokujące
- wykończenie powierzchni: chromowana, satynowa / polerowana

| YATO     | ∅ A (mm) | D1 (mm) | D2 (mm) | L (mm) | PCS packing: |        |
|----------|----------|---------|---------|--------|--------------|--------|
| YT-3820  | 6        | 10      | 17      | 63     | 10           | 50/100 |
| YT-3821  | 7        | 10      | 17      | 63     | 10           | 50/100 |
| YT-3822  | 8        | 12      | 17      | 63     | 10           | 50/100 |
| YT-3823  | 9        | 13      | 17      | 63     | 10           | 50/100 |
| YT-3824  | 10       | 14      | 17      | 63     | 10           | 50/100 |
| YT-3825  | 11       | 16      | 17      | 63     | 10           | 50/100 |
| YT-3826  | 12       | 18      | 17      | 63     | 10           | 50/100 |
| YT-3827  | 13       | 19      | 17      | 63     | 10           | 50/100 |
| YT-3828  | 14       | 20      | 19      | 63     | 10           | 50/100 |
| YT-3829  | 15       | 21      | 19      | 63     | 10           | 50/100 |
| YT-3830  | 16       | 22      | 20      | 63     | 10           | 50/100 |
| YT-3831  | 17       | 24      | 23      | 63     | 10           | 50/100 |
| YT-3832  | 18       | 25      | 23      | 63     | 10           | 50/100 |
| YT-3833  | 19       | 26      | 24      | 63     | 10           | 50/100 |
| YT-3834* | 20       | 28      | 25      | 63     | 10           | 50/100 |
| YT-3835* | 21       | 28      | 26      | 63     | 10           | 50/100 |

GB Hexagonal deep socket  
 D Sechskantenschlüssel, lange  
 PL Nasadka sześciokątna długa  
 RUS Головка шестигранная длинная  
 CZ Šestihřanný hluboký nástavec  
 H Hatszögű rátét mély  
 RO Cheie tubulară hexagonală adâncă  
 E Boquilla hexagonal larga

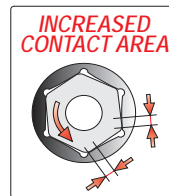

3/8" DIN 3121  
 10 mm CrV 50BV30  
 AS-DRIVE S.A.E.

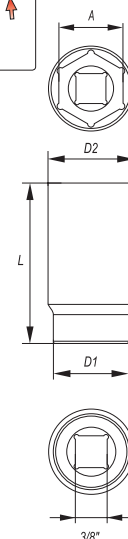

COLOR BOX

- drive locks
- surface finish: chromed, mirror
- zamki blokujące
- wykończenie powierzchni: chromowana, polerowana

| YATO     | ∅ A              | D1 (mm) | D2 (mm) | L (mm) | PCS packing: |        |
|----------|------------------|---------|---------|--------|--------------|--------|
| YT-5070* | 3/8" (9.5 mm)    | 17.0    | 14.2    | 63     | 10           | 50/100 |
| YT-5071* | 7/16" (11.1 mm)  | 17.0    | 16.3    | 63     | 10           | 50/100 |
| YT-5072* | 1/2" (12.7 mm)   | 17.0    | 18.0    | 63     | 10           | 50/100 |
| YT-5073* | 9/16" (14.3 mm)  | 18.0    | 20.0    | 63     | 10           | 50/100 |
| YT-5074* | 5/8" (15.9 mm)   | 19.0    | 22.0    | 63     | 10           | 50/100 |
| YT-5075* | 11/16" (17.5 mm) | 19.0    | 24.0    | 63     | 10           | 50/100 |
| YT-5076* | 3/4" (19.0 mm)   | 21.0    | 26.0    | 63     | 10           | 50/100 |
| YT-5077* | 13/16" (20.6 mm) | 23.0    | 28.0    | 63     | 10           | 50/100 |
| YT-5078* | 7/8" (22.2 mm)   | 24.0    | 30.0    | 63     | 10           | 50/100 |

\* - product not for european market  
 \* - produkt nieprzeznaczony na rynek europejski

GB Extension bar  
D Verlängerung  
PL Przedłużka  
RUS Удлинитель для воротка  
CZ Prodlužovací přípravek  
H Toldalék  
RO Prelungitor  
E Tubo de prolongación

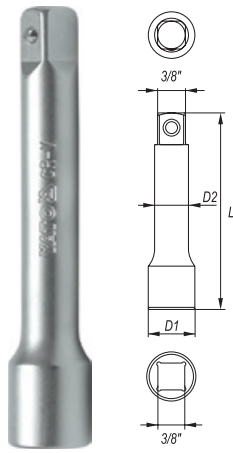

3/8" DIN 3121  
10 mm CrV 50BV30

COLOR BOX



| YATO    | Ø             | D1 (mm) | D2 (mm) | L (mm) | PCS packing: | Box     |
|---------|---------------|---------|---------|--------|--------------|---------|
| YT-3842 | 3/8" (9.5 mm) | 18.0    | 12.3    | 42.0   | 10           | 100/200 |
| YT-3843 | 3/8" (9.5 mm) | 18.0    | 12.3    | 76.0   | 10           | 100/200 |
| YT-3844 | 3/8" (9.5 mm) | 18.0    | 12.3    | 152.4  | 10           | 50/100  |
| YT-3845 | 3/8" (9.5 mm) | 18.0    | 12.3    | 254.0  | 10           | 50      |

GB Extension bar with wobble  
D Gelenkverlängerung  
PL Przedłużka uchylna  
RUS Удлинитель наклонный  
CZ Odchýlný prodlužovací přípravek  
H Csuklós toldalék  
RO Prelungitor rabatabil  
E Tubo de prolongación desviable

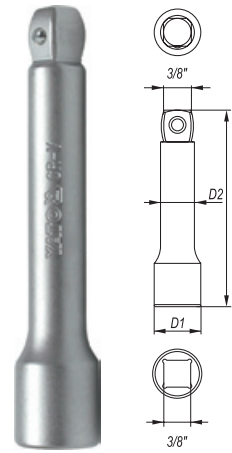

3/8" DIN 3121  
10 mm CrV 50BV30

COLOR BOX



| YATO    | Ø             | D1 (mm) | D2 (mm) | L (mm) | PCS packing: | Box     |
|---------|---------------|---------|---------|--------|--------------|---------|
| YT-3846 | 3/8" (9.5 mm) | 18.0    | 12.3    | 40.0   | 10           | 100/200 |
| YT-3847 | 3/8" (9.5 mm) | 18.0    | 12.3    | 76.0   | 10           | 100/200 |
| YT-3848 | 3/8" (9.5 mm) | 18.0    | 12.3    | 152.4  | 10           | 50/100  |
| YT-3849 | 3/8" (9.5 mm) | 18.0    | 12.3    | 254.0  | 10           | 50      |

GB Adapter  
D Reduktion  
PL Redukcja  
RUS Переходник  
CZ Redukce  
H Redukció  
RO Reducție  
E Reducción

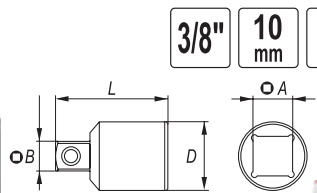

3/8" 10 mm DIN 3121 CrV 50BV30

COLOR BOX



| YATO    | Ø A               | Ø B                | D (mm) | L (mm) | PCS packing: | Box     |
|---------|-------------------|--------------------|--------|--------|--------------|---------|
| YT-3853 | 3/8" (9.5 mm) (F) | 1/4" (6.3 mm) (M)  | 17     | 27     | 10           | 250/500 |
| YT-3854 | 3/8" (9.5 mm) (F) | 1/2" (12.7 mm) (M) | 17     | 35     | 10           | 100/200 |

GB Bit adapter  
D Bithalter  
PL Adapter do bitów  
RUS Держатель винтовёртовых наконечников  
CZ Držák na šroubovakové koncovky  
H Szár a csavarhúzóvégekhez  
RO Capete şurubelniță  
E Mandril para puntas

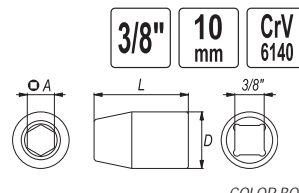

3/8" 10 mm CrV 6140

COLOR BOX



| YATO    | Ø             | Ø A  | D (mm) | L (mm) | PCS packing: | Box     |
|---------|---------------|------|--------|--------|--------------|---------|
| YT-1296 | 3/8" (9.5 mm) | 8 mm | 17.9   | 30     | 10           | 250/500 |

GB Universal joint  
D Kardangeln  
PL Przegub Cardana  
RUS Карданный шарнир  
CZ Kardanový kloub  
H Kardán csukló  
RO Articulație Cardanică  
E Articulación Cardan

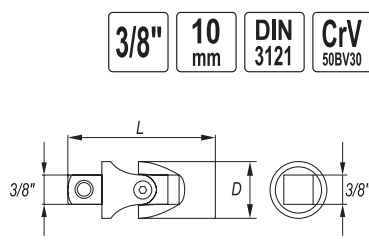

3/8" 10 mm DIN 3121 CrV 50BV30

COLOR BOX



| YATO    | Ø             | D (mm) | L (mm) | PCS packing: | Box     |
|---------|---------------|--------|--------|--------------|---------|
| YT-3850 | 3/8" (9.5 mm) | 18     | 49     | 10           | 100/200 |

GB Sliding T-bar  
D Handgriff  
RUS Вороток Т-образный  
CZ Otočná račka typ „T“  
H „T“ alakú hajtókar  
PL Pokręto typu „T“  
RO Mâner clupă tipul „T“  
E Mango tipo „T“

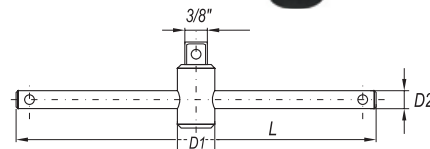

3/8" 10 mm

DIN 3121

CrV 50BV30

COLOR BOX



| YATO    | Ø             | D1 (mm) | D2 (mm) | L (mm) | PCS packing: | Box    |
|---------|---------------|---------|---------|--------|--------------|--------|
| YT-3840 | 3/8" (9.5 mm) | 20.0    | 10.7    | 198    | 10           | 50/100 |

GB Flexible handle  
D Gelenkgriff  
PL Pokręto lamane  
RUS Вороток шарнирный  
CZ Otočná lomená račka  
H Hajlított hajtókar  
RO Prelungitor cu prindere flexibilă  
E Mango articulado

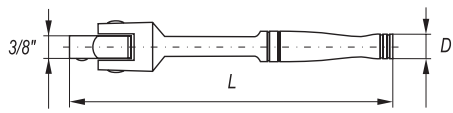

3/8" 10 mm DIN 3121 CrV 50BV30

COLOR BOX



| YATO    | Ø             | D (mm) | L (mm) | PCS packing: | Box   |
|---------|---------------|--------|--------|--------------|-------|
| YT-3839 | 3/8" (9.5 mm) | 16     | 215    | 8            | 24/48 |

GB Spark plug socket  
D Steckschlüssel mit Gummihalterung  
PL Nasadka do świec  
RUS Головка свечная  
CZ Nastavec pro svíčky  
H Gyújtógyertya toldalék  
RO Cheie de bujii  
E Boquilla de bujias

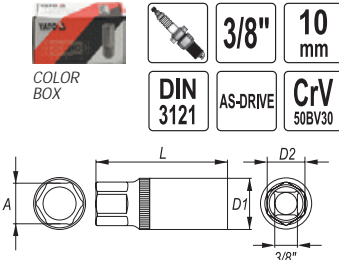

3/8" 10 mm DIN 3121 AS-DRIVE CrV 50BV30

COLOR BOX



GB Spark plug socket  
D Steckschlüssel mit Gummihalterung  
PL Nasadka do świec  
RUS Головка свечная  
CZ Nastavec pro svíčky  
H Gyújtógyertya toldalék  
RO Cheie de bujii  
E Boquilla de bujias

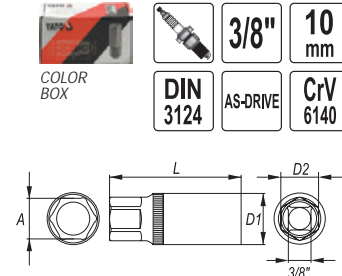

3/8" 10 mm

DIN 3124 AS-DRIVE CrV 6140

COLOR BOX



| YATO     | Ø             | A    | D1 (mm) | D2 (mm) | L (mm) | PCS packing: | Box    |
|----------|---------------|------|---------|---------|--------|--------------|--------|
| YT-3851  | 3/8" (9.5 mm) | 16.0 | 22.0    | 19.0    | 64.0   | 10           | 50/100 |
| YT-3852* | 3/8" (9.5 mm) | 21.0 | 27.8    | 22.0    | 64.0   | 10           | 50/100 |

\* - product not for european market  
\* - produkt nieprzeznaczony na rynek europejski

GB Quick release ratchet handle  
D Hebelumschaltknarre  
PL Grzechotka  
RUS Трещотка

CZ Řehtačka  
H Racsnis hajtókar  
RO Dispozitiv de prindere cu clichet  
E Carraca

PLASTIC HANGER



6 PCS



COLOR BOX

3/8"

DIN 3122

QUICK RELEASE SZYBKO-ZŁĄCZE

10 mm

72T

CrV 6140



| YATO    | Ø             | T  | L (mm) | PCS packing: | Box   |
|---------|---------------|----|--------|--------------|-------|
| YT-0308 | 3/8" (9.5 mm) | 72 | 185    | 6            | 24/48 |

| YATO    | Ø             | T  | L (mm) | PCS packing: | Box   |
|---------|---------------|----|--------|--------------|-------|
| YT-0311 | 3/8" (9.5 mm) | 72 | 200    | 6            | 18/36 |

| YATO    | Ø             | T  | L (mm) | PCS packing: | Box   |
|---------|---------------|----|--------|--------------|-------|
| YT-0314 | 3/8" (9.5 mm) | 72 | 170    | 6            | 24/48 |



| YATO    | Ø             | T  | L (mm) | PCS packing: | Box   |
|---------|---------------|----|--------|--------------|-------|
| YT-0317 | 3/8" (9.5 mm) | 72 | 200    | 6            | 24/48 |

| YATO    | Ø             | T  | L (mm) | PCS packing: | Box   |
|---------|---------------|----|--------|--------------|-------|
| YT-0320 | 3/8" (9.5 mm) | 72 | 205    | 6            | 24/48 |

| YATO    | Ø             | T  | L (mm) | PCS packing: | Box   |
|---------|---------------|----|--------|--------------|-------|
| YT-0323 | 3/8" (9.5 mm) | 72 | 197    | 6            | 24/48 |

GB Quick release ratchet handle  
D Hebelumschaltknarre  
PL Grzechotka  
RUS Трещотка с шарниром  
CZ Řehtačka

H Racsnis hajtókar  
RO Dispozitiv de prindere cu clichet  
E Carraca

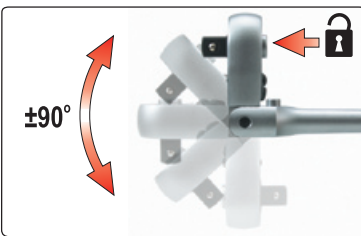

PLASTIC HANGER



6 PCS



COLOR BOX

3/8"

QUICK RELEASE SZYBKO-ZŁĄCZE

DIN 3122

10 mm

72T

CrV 6140

| YATO    | Ø             | T  | L (mm) | PCS packing: | Box   |
|---------|---------------|----|--------|--------------|-------|
| YT-0326 | 3/8" (9.5 mm) | 72 | 242    | 6            | 24/48 |

GB Quick release ratchet handle  
D Hebelumschaltknarre  
PL Grzechotka powlekana  
RUS Трещотка  
CZ Řehtačka  
H Racsnis hajtókar  
RO Dispozitiv de prindere cu clichet  
E Carraca

PLASTIC HANGER



6 PCS



3/8"

DIN 3122

10 mm

QUICK RELEASE SZYBKO-ZŁĄCZE

72T

CrV 6135



| YATO    | Ø             | T  | L (mm) | PCS packing: | Box   |
|---------|---------------|----|--------|--------------|-------|
| YT-0291 | 3/8" (9.5 mm) | 72 | 202    | 6            | 24/48 |



| YATO    | Ø             | T  | L (mm) | PCS packing: | Box   |
|---------|---------------|----|--------|--------------|-------|
| YT-0294 | 3/8" (9.5 mm) | 72 | 202    | 6            | 24/48 |

GB Quick release ratchet handle  
D Hebelumschaltknarre  
PL Grzechotka  
RUS Трещотка с шарниром  
CZ Řehtačka  
H Racsnis hajtókar  
RO Dispozitiv de prindere cu clichet  
E Carraca

PLASTIC HANGER



6 PCS



3/8"

72T

10 mm

QUICK RELEASE SZYBKO-ZŁĄCZE

CrV 6140



| YATO    | Ø             | T  | L (mm) | PCS packing: | Box   |
|---------|---------------|----|--------|--------------|-------|
| YT-0731 | 3/8" (9.5 mm) | 72 | 200    | 6            | 24/48 |

- GB Quick release ratchet handle  
 D Hebelumschaltknarre  
 PL Grzechotka  
 RUS Трещотка с шарниром  
 CZ Řehtačka  
 H Racsnis hajtókár  
 RO Dispozitiv de prindere cu clichet  
 E Carraca

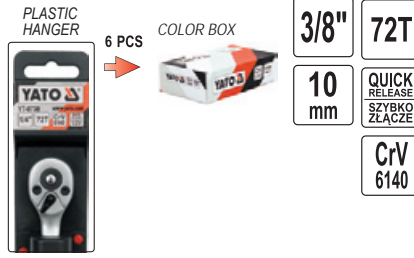

3/8" 72T  
 10 mm QUICK RELEASE SZYBKO-ZŁĄCZE  
 CrV 6140



| YATO     | Ø             | T  | L (mm) | PCS packing: |       |
|----------|---------------|----|--------|--------------|-------|
| YT-07292 | 3/8" (9.5 mm) | 72 | 200    | 6            | 24/48 |

- GB Quick release ratchet handle  
 D Hebelumschaltknarre  
 PL Grzechotka  
 RUS Трещотка с шарниром  
 CZ Řehtačka  
 H Racsnis hajtókár  
 RO Dispozitiv de prindere cu clichet  
 E Carraca

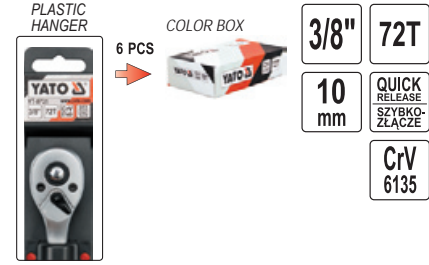

3/8" 72T  
 10 mm QUICK RELEASE SZYBKO-ZŁĄCZE  
 CrV 6135



| YATO    | Ø             | T  | L (mm) | PCS packing: |       |
|---------|---------------|----|--------|--------------|-------|
| YT-0734 | 3/8" (9.5 mm) | 72 | 200    | 6            | 24/48 |

- GB Telescopic ratchet handle  
 D Umschaltknarre  
 PL Grzechotka z przedłużanym uchwytem  
 RUS Трещотка  
 CZ Řehtačka  
 H Racsnis hajtókár  
 RO Antrenor cu clichet  
 E Carraca telescópico



3/8" 72T  
 10 mm QUICK RELEASE SZYBKO-ZŁĄCZE  
 CrV 6135



| YATO    | Ø             | T  | L (mm)  | PCS packing: |    |
|---------|---------------|----|---------|--------------|----|
| YT-0298 | 3/8" (9.5 mm) | 72 | 215-315 | 6            | 24 |

- GB Flexible ratchet handle / round head  
 D Flexible Drehkopfratsche  
 PL Grzechotka z obrotową głowicą  
 RUS Трещотка с вращательной головкой  
 CZ Ráčna s otočnou hlavou  
 H Forgófejés racsnis szár  
 RO Antrenor cu clichet flexibil  
 E Carraca con cabeza giratoria

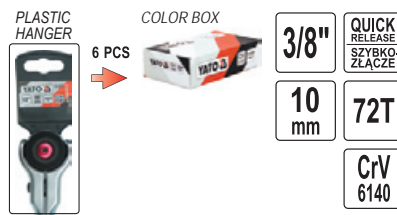

3/8" QUICK RELEASE SZYBKO-ZŁĄCZE  
 10 mm 72T  
 CrV 6140



\* - product not for european market  
 \* - produkt nieprzeznaczony na rynek europejski

| YATO     | Ø             | T  | L (mm) | PCS packing: |       |
|----------|---------------|----|--------|--------------|-------|
| YT-0721* | 3/8" (9.5 mm) | 72 | 274    | 6            | 30/60 |

- GB Ratchet handle with traction belt  
 D Ratsche mit Drehantriebsrad  
 PL Grzechotka z paskiem transmisyjnym  
 RUS Трещотка реверсионная  
 CZ Ráčna s násobičom  
 H Racsnis szár szíjhajtással  
 RO Antrenor cu clichet cu tractiune pe curea  
 E Carraca con cinta de transmisión

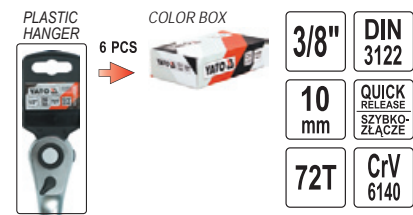

3/8" DIN 3122  
 10 mm QUICK RELEASE SZYBKO-ZŁĄCZE  
 72T CrV 6140



| YATO    | Ø             | T  | L (mm) | PCS packing: |       |
|---------|---------------|----|--------|--------------|-------|
| YT-0724 | 3/8" (9.5 mm) | 72 | 200    | 6            | 30/60 |

GB Hexagonal socket  
D Sechskantenschlüssel  
PL Nasadka sześciokątna  
RUS Головка шестигранная короткая  
CZ Šestihranný nástavec  
H Hatszögű rátét  
RO Cheie tubulară hexagonală  
E Boquilla hexagonal corta

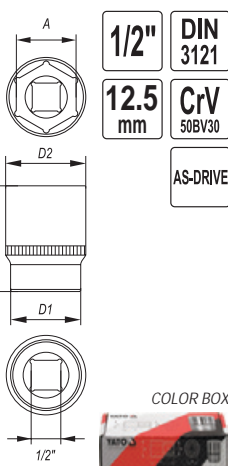
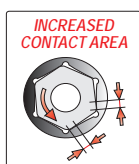

\* - product not for european market  
\* - produkt nieprzeznaczony na rynek europejski

- drive locks
- surface finish: chromed, satin / mirror
- zamki blokujące
- wykończenie powierzchni: chromowana, satynowa / polerowana

| YATO     | ∅ A (mm) | D1 (mm) | D2 (mm) | L (mm) | PCS packing: |         |
|----------|----------|---------|---------|--------|--------------|---------|
| YT-1201  | 8        | 12      | 22      | 38     | 10           | 100/200 |
| YT-1202  | 9        | 14      | 22      | 38     | 10           | 100/200 |
| YT-1203  | 10       | 15      | 22      | 38     | 10           | 100/200 |
| YT-1204  | 11       | 16      | 22      | 38     | 10           | 100/200 |
| YT-1205  | 12       | 18      | 22      | 38     | 10           | 100/200 |
| YT-1206  | 13       | 19      | 22      | 38     | 10           | 100/200 |
| YT-1207  | 14       | 20      | 22      | 38     | 10           | 100/200 |
| YT-1208  | 15       | 21      | 22      | 38     | 10           | 100/200 |
| YT-1209  | 16       | 23      | 22      | 38     | 10           | 100/200 |
| YT-1210  | 17       | 24      | 23      | 38     | 10           | 100/200 |
| YT-1211  | 18       | 25      | 23      | 38     | 10           | 100/200 |
| YT-1212  | 19       | 27      | 24      | 38     | 10           | 100/200 |
| YT-1213  | 20       | 28      | 24      | 38     | 10           | 100/200 |
| YT-1214  | 21       | 29      | 24      | 38     | 10           | 100/200 |
| YT-1215  | 22       | 30      | 26      | 38     | 10           | 100/200 |
| YT-1216  | 23       | 31      | 28      | 38     | 10           | 50/100  |
| YT-1217  | 24       | 32      | 28      | 38     | 10           | 50/100  |
| YT-1218  | 27       | 36      | 30      | 42     | 10           | 50/100  |
| YT-1219  | 30       | 40      | 34      | 42     | 10           | 50/100  |
| YT-1220  | 32       | 42      | 36      | 42     | 10           | 50/100  |
| YT-1199* | 34       | 44      | 38      | 45     | 8            | 32/64   |
| YT-1200* | 36       | 48      | 43      | 45     | 5            | 25/50   |

GB Bi-hexagonal socket  
D Zwölfkant-Steckschlüssel-Einsatz  
PL Nasadka dwunastokątna  
RUS Головка 12-гранная  
CZ Nástrčný ořech dvanáctihřanný  
H Dugófej, 12 lapú  
RO Cheie tubulară bihexagonală  
E Boquilla de anillo



- drive locks
- surface finish: chromed, satin / mirror

- zamki blokujące
- wykończenie powierzchni: chromowana, satynowa / polerowana

| YATO    | ∅ A (mm) | D1 (mm) | D2 (mm) | L (mm) | PCS packing: |         |
|---------|----------|---------|---------|--------|--------------|---------|
| YT-1270 | 8        | 12      | 22      | 38     | 10           | 100/200 |
| YT-1271 | 9        | 14      | 22      | 38     | 10           | 100/200 |
| YT-1272 | 10       | 15      | 22      | 38     | 10           | 100/200 |
| YT-1273 | 11       | 16      | 22      | 38     | 10           | 100/200 |
| YT-1274 | 12       | 17      | 22      | 38     | 10           | 100/200 |
| YT-1275 | 13       | 19      | 22      | 38     | 10           | 100/200 |
| YT-1276 | 14       | 20      | 22      | 38     | 10           | 100/200 |
| YT-1277 | 15       | 21      | 22      | 38     | 10           | 100/200 |
| YT-1278 | 16       | 23      | 22      | 38     | 10           | 100/200 |
| YT-1279 | 17       | 24      | 22      | 38     | 10           | 100/200 |
| YT-1280 | 18       | 25      | 23      | 38     | 10           | 100/200 |
| YT-1281 | 19       | 27      | 24      | 38     | 10           | 100/200 |
| YT-1282 | 20       | 28      | 24      | 38     | 10           | 100/200 |
| YT-1283 | 21       | 29      | 24      | 38     | 10           | 100/200 |
| YT-1284 | 22       | 30      | 26      | 38     | 10           | 100/200 |
| YT-1285 | 23       | 31      | 28      | 38     | 10           | 50/100  |
| YT-1286 | 24       | 32      | 28      | 38     | 10           | 50/100  |
| YT-1289 | 27       | 36      | 30      | 42     | 10           | 50/100  |
| YT-1291 | 30       | 40      | 34      | 42     | 10           | 50/100  |
| YT-1292 | 32       | 42      | 36      | 42     | 10           | 50/100  |

GB Hexagonal socket  
D Sechskantenschlüssel  
PL Nasadka sześciokątna  
RUS Головка шестигранная короткая  
CZ Šestihranný nástavec  
H Hatszögű rátét  
RO Cheie tubulară hexagonală  
E Boquilla hexagonal corta

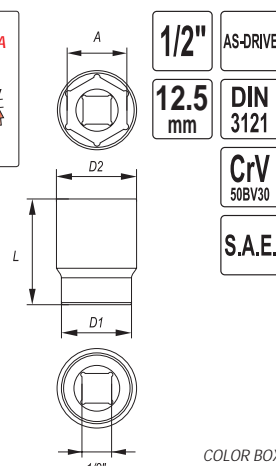
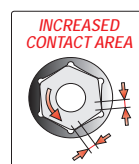

\* - product not for european market  
\* - produkt nieprzeznaczony na rynek europejski

- drive locks
- surface finish: chromed, mirror
- zamki blokujące
- wykończenie powierzchni: chromowana, polerowana

| YATO     | ∅ A               | D1 (mm) | D2 (mm) | L (mm) | PCS packing: |         |
|----------|-------------------|---------|---------|--------|--------------|---------|
| YT-5079* | 5/16" (7.9 mm)    | 12.4    | 22.0    | 38     | 10           | 100/200 |
| YT-5080* | 3/8" (9.5 mm)     | 14.7    | 22.0    | 38     | 10           | 100/200 |
| YT-5081* | 7/16" (11.1 mm)   | 17.0    | 22.0    | 38     | 10           | 100/200 |
| YT-5082* | 1/2" (12.7 mm)    | 19.0    | 22.0    | 38     | 10           | 100/200 |
| YT-5083* | 9/16" (14.3 mm)   | 20.8    | 22.0    | 38     | 10           | 100/200 |
| YT-5084* | 5/8" (15.9 mm)    | 22.0    | 21.2    | 38     | 10           | 100/200 |
| YT-5085* | 11/16" (17.5 mm)  | 24.0    | 23.5    | 38     | 10           | 100/200 |
| YT-5086* | 3/4" (19.0 mm)    | 26.0    | 24.0    | 38     | 10           | 100/200 |
| YT-5087* | 13/16" (20.6 mm)  | 28.0    | 24.0    | 38     | 10           | 100/200 |
| YT-5088* | 7/8" (22.2 mm)    | 30.0    | 26.0    | 38     | 10           | 50/100  |
| YT-5089* | 15/16" (23.8 mm)  | 32.0    | 26.0    | 40     | 10           | 50/100  |
| YT-5090* | 1" (25.4 mm)      | 34.0    | 27.5    | 43     | 10           | 50/100  |
| YT-5091* | 1-1/16" (27.0 mm) | 36.0    | 29.0    | 43     | 10           | 50/100  |
| YT-5092* | 1-1/8" (28.6 mm)  | 38.0    | 30.5    | 44     | 10           | 50/100  |
| YT-5093* | 1-1/4" (31.8 mm)  | 42.0    | 34.0    | 45     | 10           | 50/100  |

GB Spline socket  
D Steckschlüssel Spline  
PL Nasadka Spline  
RUS Головка Spline

CZ Nástrčný kľúč profil Spline  
H Spline dugófej  
RO Cheie tubulară cu stifturi  
E Boquilla Spline

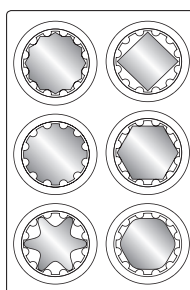

- drive locks
- enables to undo 5 types of screws
- allows to unscrew nuts damaged in 70%
- surface finish: chromed, satin / mirror
- zamki blokujące
- możliwość odkręcenia 5 rodzajów śrub
- możliwość odkręcenia nasadek zniszczonych w 70%
- wykończenie powierzchni: chromowana, satynowa / polerowana

| YATO    | ∅ A (mm) | D1 (mm) | D2 (mm) | L (mm) | PCS packing: |         |
|---------|----------|---------|---------|--------|--------------|---------|
| YT-1460 | 8        | 13      | 22      | 38     | 10           | 100/200 |
| YT-1461 | 9        | 15      | 22      | 38     | 10           | 100/200 |
| YT-1462 | 10       | 16      | 22      | 38     | 10           | 100/200 |
| YT-1463 | 11       | 17      | 22      | 38     | 10           | 100/200 |
| YT-1464 | 12       | 18      | 22      | 38     | 10           | 100/200 |
| YT-1465 | 13       | 19      | 22      | 38     | 10           | 100/200 |
| YT-1466 | 14       | 20      | 22      | 38     | 10           | 100/200 |
| YT-1467 | 15       | 22      | 23      | 38     | 10           | 100/200 |
| YT-1468 | 16       | 23      | 22      | 38     | 10           | 100/200 |
| YT-1469 | 17       | 25      | 23      | 38     | 10           | 100/200 |
| YT-1470 | 18       | 26      | 23      | 38     | 10           | 100/200 |
| YT-1471 | 19       | 27      | 24      | 38     | 10           | 100/200 |
| YT-1472 | 20       | 28      | 24      | 38     | 10           | 100/200 |
| YT-1473 | 21       | 30      | 24      | 38     | 10           | 100/200 |
| YT-1474 | 22       | 31      | 26      | 38     | 10           | 100/200 |
| YT-1475 | 23       | 32      | 28      | 38     | 10           | 50/100  |
| YT-1476 | 24       | 34      | 28      | 38     | 10           | 50/100  |
| YT-1478 | 27       | 37      | 30      | 42     | 10           | 50/100  |
| YT-1480 | 30       | 41      | 34      | 42     | 10           | 50/100  |
| YT-1481 | 32       | 44      | 36      | 45     | 10           | 50/100  |

- GB Hexagonal deep socket
- D Sechskantenschlüssel, lange
- PL Nasadka sześciokątna długa
- RUS Головка шестигранная  
длинная
- CZ Šestihřanný hluboký nástavec
- H Hatszögű rátét mély
- RO Cheie tubulară  
hexagonală adâncă
- E Boquilla hexagonal  
larga



**1/2"** **DIN 3121**  
**12.5 mm** **CrV 50BV30**  
**AS-DRIVE**

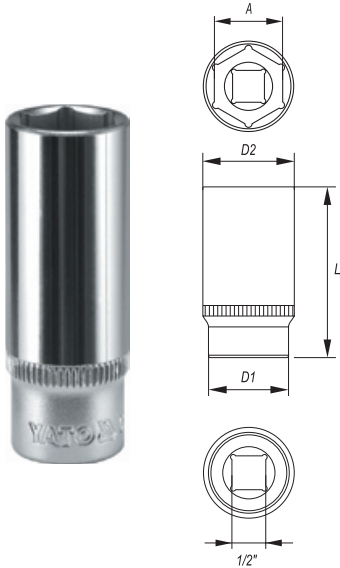

- drive locks
- surface finish: chromed, satin / mirror
- zamki blokujące
- wykończenie powierzchni: chromowana, satynowa / polerowana

COLOR BOX



| YATO    | ∅ A (mm) | D1 (mm) | D2 (mm) | L (mm) | PCS packing |        |
|---------|----------|---------|---------|--------|-------------|--------|
| YT-1221 | 8        | 13      | 22      | 76     | 10          | 50/100 |
| YT-1222 | 9        | 14      | 22      | 76     | 10          | 50/100 |
| YT-1223 | 10       | 15      | 22      | 76     | 10          | 50/100 |
| YT-1224 | 11       | 17      | 22      | 76     | 10          | 50/100 |
| YT-1225 | 12       | 18      | 22      | 76     | 10          | 50/100 |
| YT-1226 | 13       | 19      | 22      | 76     | 10          | 50/100 |
| YT-1227 | 14       | 20      | 22      | 76     | 10          | 50/100 |
| YT-1228 | 15       | 21      | 22      | 76     | 10          | 50/100 |
| YT-1229 | 16       | 24      | 22      | 76     | 10          | 50/100 |
| YT-1230 | 17       | 24      | 22      | 76     | 10          | 50/100 |
| YT-1231 | 18       | 25      | 23      | 76     | 10          | 50/100 |
| YT-1232 | 19       | 27      | 24      | 76     | 10          | 50/100 |
| YT-1233 | 20       | 28      | 24      | 76     | 10          | 50/100 |
| YT-1234 | 21       | 29      | 24      | 76     | 10          | 50/100 |
| YT-1235 | 22       | 30      | 26      | 76     | 10          | 50/100 |
| YT-1236 | 23       | 31      | 28      | 76     | 10          | 50/100 |
| YT-1237 | 24       | 32      | 28      | 76     | 10          | 50/100 |
| YT-1238 | 27       | 36      | 30      | 76     | 10          | 50     |
| YT-1239 | 30       | 40      | 36      | 76     | 10          | 20/40  |
| YT-1240 | 32       | 42      | 38      | 76     | 10          | 20/40  |

- GB Hexagonal deep socket
- D Sechskantenschlüssel, lange
- PL Nasadka sześciokątna długa
- RUS Головка шестигранная  
длинная
- CZ Šestihřanný hluboký nástavec
- H Hatszögű rátét mély
- RO Cheie tubulară  
hexagonală adâncă
- E Boquilla hexagonal  
larga

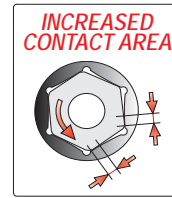

**1/2"** **DIN 3121**  
**12.5 mm** **CrV 50BV30**  
**AS-DRIVE** **S.A.E.**

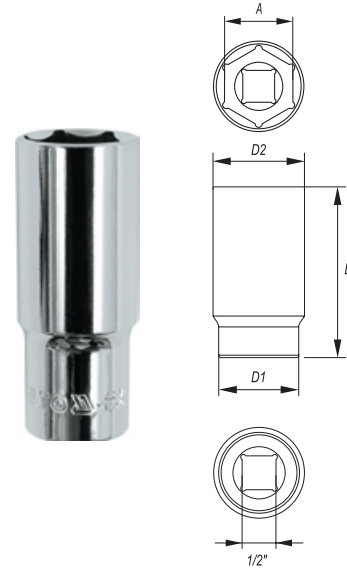

- drive locks
- surface finish: chromed, mirror
- zamki blokujące
- wykończenie powierzchni: chromowana, polerowana

COLOR BOX



| YATO     | ∅ A               | D1 (mm) | D2 (mm) | L (mm) | PCS packing |        |
|----------|-------------------|---------|---------|--------|-------------|--------|
| YT-5094* | 3/8" (9.5 mm)     | 14.7    | 22.0    | 78     | 10          | 50/100 |
| YT-5095* | 7/16" (11.1 mm)   | 17.0    | 22.0    | 78     | 10          | 50/100 |
| YT-5096* | 1/2" (12.7 mm)    | 19.0    | 22.0    | 78     | 10          | 50/100 |
| YT-5097* | 9/16" (14.3 mm)   | 20.8    | 22.0    | 78     | 10          | 50/100 |
| YT-5098* | 5/8" (15.9 mm)    | 22.0    | 21.3    | 78     | 10          | 50/100 |
| YT-5099* | 11/16" (17.5 mm)  | 24.0    | 23.3    | 78     | 10          | 50/100 |
| YT-5100* | 3/4" (19.0 mm)    | 26.0    | 24.0    | 78     | 10          | 50/100 |
| YT-5101* | 13/16" (20.6 mm)  | 28.0    | 24.0    | 78     | 10          | 50/100 |
| YT-5102* | 7/8" (22.2 mm)    | 30.0    | 28.0    | 78     | 10          | 50/100 |
| YT-5103* | 15/16" (23.8 mm)  | 32.0    | 28.0    | 78     | 10          | 50/100 |
| YT-5104* | 1" (25.4 mm)      | 34.0    | 30.5    | 78     | 10          | 50/100 |
| YT-5105* | 1-1/16" (27.0 mm) | 36.0    | 32.0    | 78     | 10          | 50     |
| YT-5106* | 1-1/8" (28.6 mm)  | 38.0    | 33.5    | 78     | 10          | 20/40  |
| YT-5107* | 1-1/4" (31.8 mm)  | 42.0    | 36.0    | 78     | 10          | 20/40  |

\* - product not for european market  
\* - produkt nieprzeznaczony na rynek europejski

- GB Extension bar
- D Verlängerung
- PL Przedłużka
- RUS Удлинитель  
для воротка
- CZ Prodlužovací přípravek
- H Toldalék
- RO Prelungitor
- E Tubo de prolongación

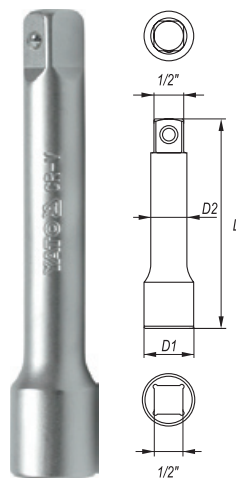

**1/2"** **DIN 3121**  
**12.5 mm** **CrV 50BV30**

COLOR BOX



| YATO    | ∅              | D1 (mm) | D2 (mm) | L (mm) | PCS packing |        |
|---------|----------------|---------|---------|--------|-------------|--------|
| YT-1246 | 1/2" (12.7 mm) | 24.0    | 14.5    | 76     | 15          | 30/120 |
| YT-1247 | 1/2" (12.7 mm) | 24.0    | 14.5    | 127    | 5           | 20/80  |
| YT-1248 | 1/2" (12.7 mm) | 24.0    | 14.5    | 254    | 5           | 20/40  |

- GB Extension bar with wobble
- D Gelenverlängerung
- PL Przedłużka uchylna
- RUS Удлинитель наклонный
- CZ Odchylný prodlužovací přípravek
- H Csuklós toldalék
- RO Prelungitor rabatabil
- E Tubo de prolongación desviable

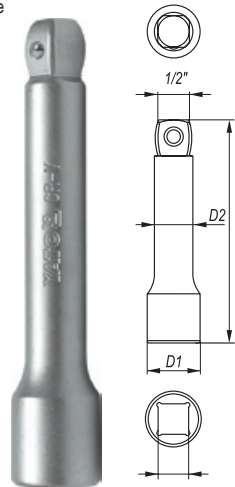

**1/2"** **DIN 3121**  
**12.5 mm** **CrV 50BV30**

COLOR BOX



| YATO    | ∅              | D1 (mm) | D2 (mm) | L (mm) | PCS packing |        |
|---------|----------------|---------|---------|--------|-------------|--------|
| YT-1249 | 1/2" (12.7 mm) | 24.0    | 14.5    | 76     | 15          | 30/120 |
| YT-1250 | 1/2" (12.7 mm) | 24.0    | 14.5    | 127    | 5           | 20/80  |
| YT-1251 | 1/2" (12.7 mm) | 24.0    | 14.5    | 254    | 5           | 20/40  |

GB Adapter  
D Redukcja  
PL Redukcja

RUS Переходник  
CZ Redukce  
H Redukció

RO Reducție  
E Reducció

1/2" 3/4" DIN 3121

12.5 mm 19 mm CrV 50BV30

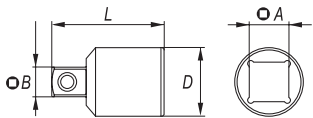

| YATO    | O A                | O B                | D (mm) | L (mm) | PCS packing | Box     |
|---------|--------------------|--------------------|--------|--------|-------------|---------|
| YT-1255 | 1/2" (12.7 mm) (F) | 3/8" (9.5 mm) (M)  | 22     | 34.0   | 10          | 100/200 |
| YT-1258 | 1/2" (12.7 mm) (F) | 3/4" (19.0 mm) (M) | 27     | 45.5   | 10          | 50/100  |
| YT-1259 | 3/4" (19.0 mm) (F) | 1/2" (12.7 mm) (M) | 35     | 51.0   | 5           | 50/100  |
| YT-1356 | 1/2" (12.7 mm) (F) | 3/4" (19.0 mm) (M) | 26     | 48.0   | 12          | 48      |

GB Universal joint  
D Kardangelenk  
PL Przegub Cardana  
RUS Карданный шарнир

CZ Kardanový kloub  
H Kardán csukló  
RO Articulație Cardanică  
E Articulación Cardan

1/2" DIN 3121

12.5 mm CrV 50BV30

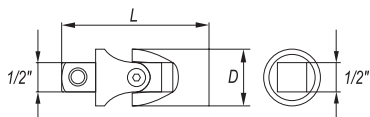

| YATO    | O              | D (mm) | L (mm) | PCS packing | Box    |
|---------|----------------|--------|--------|-------------|--------|
| YT-1252 | 1/2" (12.7 mm) | 25     | 69     | 5           | 50/100 |

GB Flexible handle  
D Gelengriff  
PL Pokręto łamane  
RUS Вороток шарнирный  
CZ Otočná lomená ráčka  
H Hajlított hajtókar  
RO Prelungitor cu prindere flexibilă  
E Mango articulado

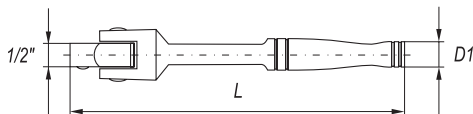
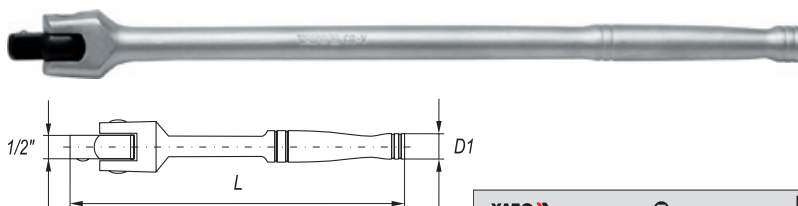

| YATO    | O              | D (mm) | L (mm) | PCS packing | Box   |
|---------|----------------|--------|--------|-------------|-------|
| YT-1241 | 1/2" (12.7 mm) | 19     | 360    | 5           | 15/30 |
| YT-1242 | 1/2" (12.7 mm) | 20     | 457    | 5           | 10/20 |

GB L-type handle  
D Admutternschlüssel  
PL Pokręto typu „L”  
RUS Вороток 1/2" тип „L”  
CZ Páka zahnutá  
H „L” alakú hajtókar  
RO Măner clupă tipul „L”  
E Mango tipo „L”



| YATO    | O              | D (mm) | L (mm) | PCS packing | Box |
|---------|----------------|--------|--------|-------------|-----|
| YT-1244 | 1/2" (12.7 mm) | 16.5   | 317    | 3           | 36  |

GB Spark plug socket  
D Steckschlüssel mit Gummihalterung  
PL Nasadka do świec  
RUS Головка свечная  
CZ Nastavec pro svíčky  
H Gyújtógyertya toldalék  
RO Cheie de bujii  
E Boquilla de bujías

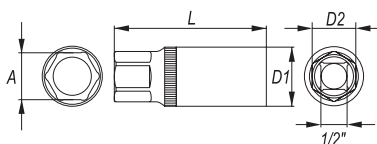

| YATO    | O              | A    | D1 (mm) | D2 (mm) | L (mm) | PCS packing | Box    |
|---------|----------------|------|---------|---------|--------|-------------|--------|
| YT-1253 | 1/2" (12.7 mm) | 16.0 | 22.0    | 19.0    | 64.0   | 10          | 50/100 |
| YT-1254 | 1/2" (12.7 mm) | 21.0 | 27.8    | 24.0    | 64.0   | 10          | 50/100 |

GB Bit adapter  
D Bithalter  
PL Adapter do bitów  
RUS Держатель винтовёртовых наконечников

CZ Držák na šroubovankové koncovky  
H Szár a csavarhúzóvégekhez  
RO Capete șurubelniță  
E Mandril para puntas

1/2" 12.5 mm CrV 6140

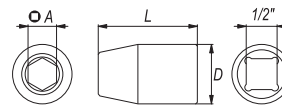

| YATO    | O              | O A  | D (mm) | L (mm) | PCS packing | Box     |
|---------|----------------|------|--------|--------|-------------|---------|
| YT-1295 | 1/2" (12.7 mm) | 8 mm | 21.9   | 38     | 10          | 250/500 |

GB Sliding T-bar  
D Handgriff mit Gleitstück  
PL Pokręto typu „T”

RUS Вороток Т-образный  
CZ Otočná ráčka typ „T”  
H „T” alakú hajtókar  
RO Măner clupă tipul „T”

1/2" 12.5 mm DIN 3121 CrV 50BV30

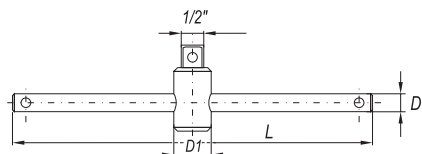

| YATO    | O              | D1 (mm) | D2 (mm) | L (mm) | PCS packing | Box   |
|---------|----------------|---------|---------|--------|-------------|-------|
| YT-1243 | 1/2" (12.7 mm) | 24.0    | 13.5    | 255    | 4           | 24/48 |

GB Quick release ratchet handle  
 D Hebelumschaltknarre  
 PL Grzechotka  
 RUS Трещотка

CZ Řehtačka  
 H Racsnis hajtókar  
 RO Dispozitiv de prindere cu clichet  
 E Carraca

PLASTIC HANGER



6 PCS



COLOR BOX

1/2" DIN 3122  
 12.5 mm 72T CrV 6140



| YATO    | Ø              | T  | L (mm) | PCS packing | Box |
|---------|----------------|----|--------|-------------|-----|
| YT-0309 | 1/2" (12.7 mm) | 72 | 278    | 6           | 24  |

| YATO    | Ø              | T  | L (mm) | PCS packing | Box   |
|---------|----------------|----|--------|-------------|-------|
| YT-0312 | 1/2" (12.7 mm) | 72 | 250    | 6           | 12/24 |

| YATO    | Ø              | T  | L (mm) | PCS packing | Box |
|---------|----------------|----|--------|-------------|-----|
| YT-0315 | 1/2" (12.7 mm) | 72 | 250    | 6           | 24  |



| YATO    | Ø              | T  | L (mm) | PCS packing | Box |
|---------|----------------|----|--------|-------------|-----|
| YT-0318 | 1/2" (12.7 mm) | 72 | 250    | 6           | 24  |

| YATO    | Ø              | T  | L (mm) | PCS packing | Box |
|---------|----------------|----|--------|-------------|-----|
| YT-0321 | 1/2" (12.7 mm) | 72 | 255    | 6           | 24  |

| YATO    | Ø              | T  | L (mm) | PCS packing | Box |
|---------|----------------|----|--------|-------------|-----|
| YT-0324 | 1/2" (12.7 mm) | 72 | 265    | 6           | 24  |

GB Quick release ratchet handle  
 D Hebelumschaltknarre  
 PL Grzechotka  
 RUS Трещотка с шарниром  
 CZ Řehtačka

H Racsnis hajtókar  
 RO Dispozitiv de prindere cu clichet  
 E Carraca

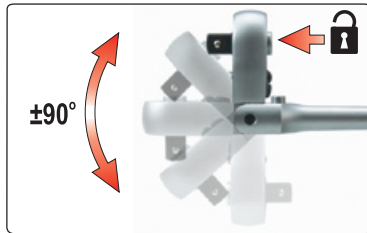

PLASTIC HANGER



6 PCS



COLOR BOX

1/2" QUICK RELEASE SZYBKO-ZŁĄCZE DIN 3122  
 12.5 mm 72T CrV 6140

| YATO    | Ø              | T  | L (mm) | PCS packing | Box |
|---------|----------------|----|--------|-------------|-----|
| YT-0327 | 1/2" (12.7 mm) | 72 | 290    | 6           | 24  |

GB Quick release ratchet handle  
 D Hebelumschaltknarre  
 PL Grzechotka powlekana  
 RUS Трещотка  
 CZ Řehtačka  
 H Racsnis hajtókar  
 RO Dispozitiv de prindere cu clichet  
 E Carraca

PLASTIC HANGER



6 PCS



1/2" DIN 3122  
 12.5 mm QUICK RELEASE SZYBKO-ZŁĄCZE  
 72T CrV 6135



| YATO    | Ø              | T  | L (mm) | PCS packing | Box |
|---------|----------------|----|--------|-------------|-----|
| YT-0292 | 1/2" (12.7 mm) | 72 | 257    | 6           | 24  |



| YATO    | Ø              | T  | L (mm) | PCS packing | Box |
|---------|----------------|----|--------|-------------|-----|
| YT-0295 | 1/2" (12.7 mm) | 72 | 257    | 6           | 24  |

GB Quick release ratchet handle  
 D Hebelumschaltknarre  
 PL Grzechotka  
 RUS Трещотка с шарниром  
 CZ Řehtačka  
 H Racsnis hajtókar  
 RO Dispozitiv de prindere cu clichet  
 E Carraca

PLASTIC HANGER



6 PCS



1/2" 72T  
 12.5 mm QUICK RELEASE SZYBKO-ZŁĄCZE  
 CrV 6140



| YATO    | Ø              | T  | L (mm) | PCS packing | Box |
|---------|----------------|----|--------|-------------|-----|
| YT-0732 | 1/2" (12.7 mm) | 72 | 255    | 6           | 24  |



GB Quick release ratchet handle  
 D Hebelumschaltknarre  
 PL Grzechotka  
 RUS Трещотка с шарниром  
 CZ Řehtačka  
 H Racsnis hajtókar  
 RO Dispozitiv de prindere cu clichet  
 E Carraca



1/2" 72T  
 12.5 mm QUICK RELEASE SZYBKO-ZŁĄCZE  
 CrV 6140



| YATO     | Ø              | T  | L (mm) | PCS packing: | ☐  |
|----------|----------------|----|--------|--------------|----|
| YT-07293 | 1/2" (12.7 mm) | 72 | 255    | 6            | 24 |

GB Quick release ratchet handle  
 D Hebelumschaltknarre  
 PL Grzechotka  
 RUS Трещотка с шарниром  
 CZ Řehtačka  
 H Racsnis hajtókar  
 RO Dispozitiv de prindere cu clichet  
 E Carraca



1/2" 72T  
 12.5 mm QUICK RELEASE SZYBKO-ZŁĄCZE  
 CrV 6135



| YATO    | Ø              | T  | L (mm) | PCS packing: | ☐  |
|---------|----------------|----|--------|--------------|----|
| YT-0735 | 1/2" (12.7 mm) | 72 | 255    | 6            | 24 |

GB Telescopic ratchet handle  
 D Umschaltknarre  
 PL Grzechotka z przedłużonym uchwytem  
 RUS Трещотка  
 CZ Řehtačka  
 H Racsnis hajtókar  
 RO Antrenor cu clichet  
 E Carraca telescópico



1/2" 72T  
 12.5 mm QUICK RELEASE SZYBKO-ZŁĄCZE  
 CrV 6135

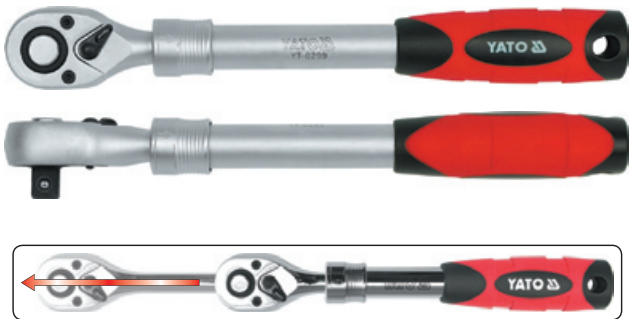

| YATO    | Ø              | T  | L (mm)  | PCS packing: | ☐  |
|---------|----------------|----|---------|--------------|----|
| YT-0299 | 1/2" (12.7 mm) | 72 | 305-445 | 6            | 24 |

GB Extended ratchet set  
 D Ratsche mit Verlängerung  
 PL Komplet przedłużka z grzechotką  
 RUS Набор удлинитель с трещеткой  
 CZ Prodlužovací ráčnová sada  
 H Racsnis szár hosszabbítóval  
 RO Set prelungitor si cheie  
 E Alargadera con carraca



1/2" 72T  
 12.5 mm QUICK RELEASE SZYBKO-ZŁĄCZE  
 CrMo 4130 CrV 6130



\* - product not for european market  
 \* - produkt nieprzeznaczony na rynek europejski

| YATO     | Ø              | T  | L (mm)  | L (mm)  | ☐ |
|----------|----------------|----|---------|---------|---|
| YT-0300* | 1/2" (12.7 mm) | 72 | 265-415 | 280-420 | 6 |

GB Flexible ratchet handle / round head  
 D Flexible Drehkopfratsche  
 PL Grzechotka z obrotową głowicą  
 RUS Трещотка с вращательной головкой  
 CZ Ráčna s otočnou hlavou  
 H Forgófejes racsnis szár  
 RO Antrenor cu clichet flexibil  
 E Carraca con cabeza giratoria

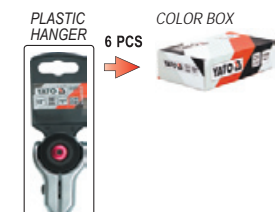

1/2" 72T  
 12.5 mm QUICK RELEASE SZYBKO-ZŁĄCZE  
 CrV 6140



| YATO    | Ø              | T  | L (mm) | PCS packing: | ☐  |
|---------|----------------|----|--------|--------------|----|
| YT-0722 | 1/2" (12.7 mm) | 72 | 280    | 6            | 30 |

GB Ratchet handle with traction belt  
 D Ratsche mit Drehantriebsrad  
 PL Grzechotka z paskiem transmisyjnym  
 RUS Трещотка реверсионная  
 CZ Ráčna s násobíčem  
 H Racsnis szár szíjhajtással  
 RO Antrenor cu clichet cu tractiune pe curea  
 E Carraca con cinta de transmisión

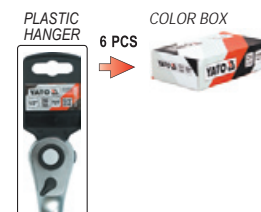

1/2" 72T  
 12.5 mm QUICK RELEASE SZYBKO-ZŁĄCZE  
 CrV 6140

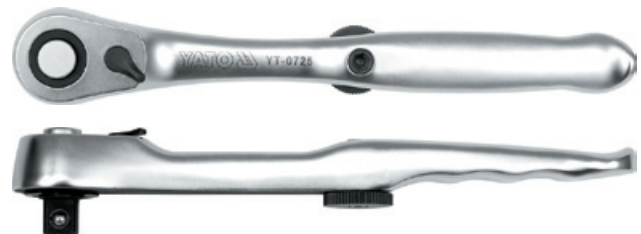

| YATO    | Ø              | T  | L (mm) | PCS packing: | ☐  |
|---------|----------------|----|--------|--------------|----|
| YT-0725 | 1/2" (12.7 mm) | 72 | 250    | 6            | 30 |

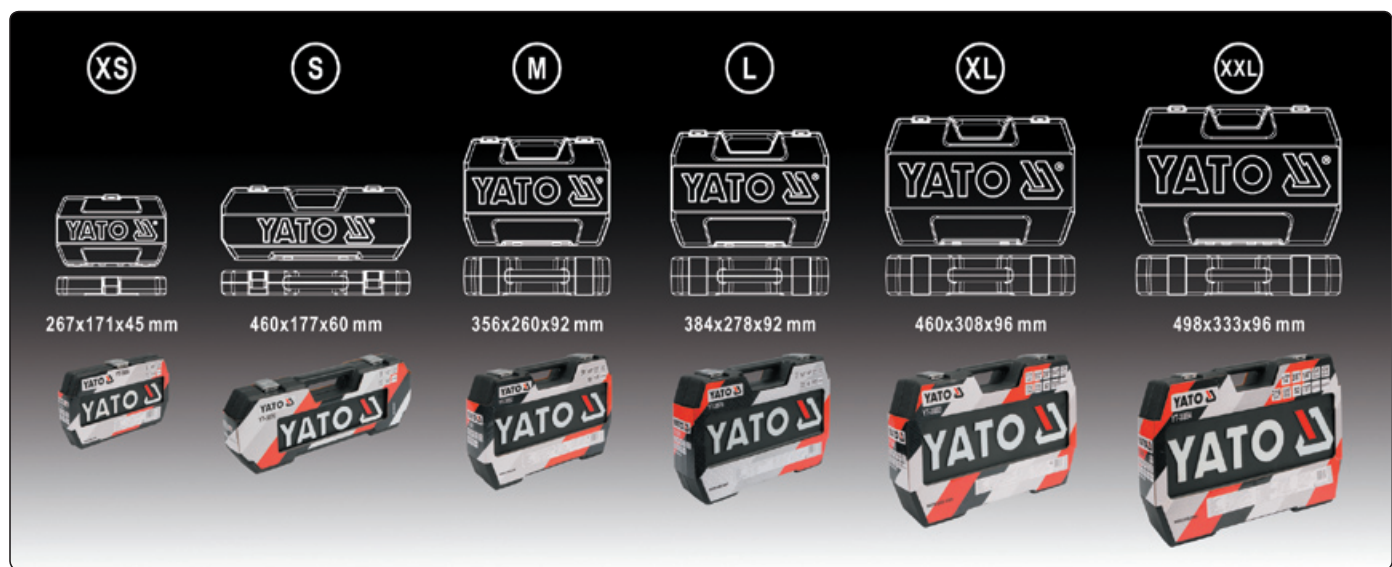

**GB** Socket set  
**D** Sechskant-Steckschlüssel-Satz  
**PL** Komplet nasadek dlugich  
**RUS** Набор насадок  
**CZ** Sada nástrčných klíčů  
**H** Dugókulcs készlet  
**RO** Trusă chei tubulare  
**E** Juego de herramientas

**8** PCS  
**1/4"**  
**6.3** mm  
**CrV** 50BV30  
**AS-DRIVE**



1/4" (6.3 mm): 5.5, 6, 7, 8, 9, 10, 12, 13 mm  
 (L=50 mm); CrV 50BV30



1/4" (6.3 mm): 5.5, 6, 7, 8, 9, 10, 12, 13 mm  
 (L=50 mm); CrV 50BV30



|             |               |    |
|-------------|---------------|----|
| <b>YATO</b> |               |    |
| YT-1439     | 1/4" (6.3 mm) | 20 |

|             |               |    |
|-------------|---------------|----|
| <b>YATO</b> |               |    |
| YT-1443     | 1/4" (6.3 mm) | 10 |

**GB** Socket set  
**D** Sechskantenschlüssel-Einsatz  
**PL** Komplet nasadek z akcesoriami  
**RUS** Набор торцевых головок  
**CZ** Sada nástrčných klíčů a ráčny  
**H** Dugókulcs készlet racsnis hajtókarral  
**RO** Trusă chei tubulare cu antrenor  
**E** Juego de boquillas con accesorios



**1/4"**  
**6.3** mm  
**CrV** 50BV30  
**72T**  
**AS-DRIVE**



**15** PCS

1/4" (6.3 mm): 4, 5, 6, 7, 8, 9, 10, 12, 13 mm (L=25 mm); CrV 50BV30;  
 1/4" (6.3 mm): (50.8, 152.4 mm); CrV 50BV30; 1/4" (6.3 mm): CrV 50BV30;  
 1/4" (6.3 mm): (127 mm); 72T; CrV 6140; 1/4" (6.3 mm): (150 mm); CrV 50BV30;

|             |               |    |
|-------------|---------------|----|
| <b>YATO</b> |               |    |
| YT-1441     | 1/4" (6.3 mm) | 10 |



**23** PCS

1/4" (6.3 mm): 4, 5, 6, 7, 8, 9, 10, 12, 13 mm (L=25 mm); CrV 50BV30; 1/4" (6.3 mm): 4, 5, 6, 7, 8, 9, 10, 12, 13 mm (L=50 mm); CrV 50BV30; 1/4" (6.3 mm): (50.8, 152.4 mm); CrV 50BV30; 1/4" (6.3 mm): CrV 50BV30; 1/4" (6.3 mm): (127 mm); 72T; CrV 6140; 1/4" (6.3 mm): (150 mm); CrV 50BV30

|             |               |    |
|-------------|---------------|----|
| <b>YATO</b> |               |    |
| YT-1442     | 1/4" (6.3 mm) | 10 |

GB Tool set  
 D Sechskant-Steckschlüssel-Satz  
 PL Zestaw narzędziowy  
 RUS Набор инструмента

CZ Sada nástrčných klíčů a ráčny  
 H Dugókulcs készlet racsniel hajtókarral  
 RO Rotruasa chei tubulare cu antrenor  
 E Juego de herramientas

METAL CASE &  
 COLOR SLEEVE



1/4"  
 6.3 mm  
 CrV  
 6140  
 72T  
 CrV  
 50BV30  
 AS-DRIVE



15  
 PCS

1/4" (6.3 mm): 4, 5, 6, 7, 8, 9, 10, 12, 13 mm (L=25 mm); CrV 50BV30;  
 1/4" (6.3 mm): (50.8, 152.4 mm); CrV 50BV30;  
 1/4" (6.3 mm): (127 mm); 72T; CrV 6140;  
 1/4" (6.3 mm): (150 mm); CrV 50BV30;

|             |               |    |
|-------------|---------------|----|
| <b>YATO</b> |               |    |
| YT-14411    | 1/4" (6.3 mm) | 10 |



23  
 PCS

1/4" (6.3 mm): 4, 5, 6, 7, 8, 9, 10, 12, 13 mm (L=25 mm); CrV 50BV30;  
 1/4" (6.3 mm): 4, 5, 6, 7, 8, 9, 10, 12, 13 mm (L=50 mm); CrV 50BV30;  
 1/4" (6.3 mm): (50.8, 152.4 mm); CrV 50BV30;  
 1/4" (6.3 mm): (127 mm); 72T; CrV 6140;  
 1/4" (6.3 mm): (150 mm); CrV 50BV30

|             |               |    |
|-------------|---------------|----|
| <b>YATO</b> |               |    |
| YT-14421    | 1/4" (6.3 mm) | 10 |

GB Tool set  
 D Sechskant-Steckschlüssel-Satz  
 PL Zestaw narzędziowy  
 RUS Набор инструмента

CZ Sada nástrčných klíčů a ráčny  
 H Dugókulcs készlet racsniel hajtókarral  
 RO Rotruasa chei tubulare cu antrenor  
 E Juego de herramientas

BMC & COLOR SLEEVE  
 XS SIZE



1/4"  
 6.3 mm  
 CrV  
 6140  
 72T  
 CrV  
 50BV30  
 AS-DRIVE



15  
 PCS

1/4" (6.3 mm): 4, 5, 6, 7, 8, 9, 10, 12, 13 mm (L=25 mm); CrV 50BV30;  
 1/4" (6.3 mm): (50.8, 152.4 mm); CrV 50BV30;  
 1/4" (6.3 mm); CrV 50BV30;  
 1/4" (6.3 mm): (155 mm); 72T; CrV 6140;  
 1/4" (6.3 mm): (150 mm); CrV 50BV30;

|             |               |    |
|-------------|---------------|----|
| <b>YATO</b> |               |    |
| YT-1444     | 1/4" (6.3 mm) | 10 |



20  
 PCS

1/4" (6.3 mm): 3.5, 4, 4.5, 5, 5.5, 6, 7, 8, 9, 10, 11, 12, 13, 14 mm (L=25 mm); CrV 50BV30;  
 1/4" (6.3 mm): (50.8, 152.4 mm); CrV 50BV30;  
 1/4" (6.3 mm); CrV 50BV30;  
 1/4" (6.3 mm): (152.4 mm); CrV 50BV30;  
 1/4" (6.3 mm): (155 mm); 72T; CrV 6140;  
 1/4" (6.3 mm): (150 mm); CrV 50BV30

|             |               |    |
|-------------|---------------|----|
| <b>YATO</b> |               |    |
| YT-1449     | 1/4" (6.3 mm) | 10 |

GB Tool set  
 D Sechskant-Steckschlüssel-Satz  
 PL Zestaw narzędziowy  
 RUS Набор инструмента

CZ Sada nástrčných klíčů a ráčny  
 H Dugókulcs készlet racsnis hajtókarral  
 RO Rotruşa chei tubulare cu antrenor  
 E Juego de herramientas

BMC & COLOR SLEEVE  
 XS SIZE



1/4" CrV 6140 72T  
 6.3 mm CrV 50BV30 AS-DRIVE



23  
 PCS

- 1/4" (6.3 mm): 4, 5, 6, 7, 8, 9, 10, 12, 13 mm (L=25 mm); CrV 50BV30;
- 1/4" (6.3 mm): 4, 5, 6, 7, 8, 9, 10, 12, 13 mm (L=50 mm); CrV 50BV30;
- 1/4" (6.3 mm): (50.8, 152.4 mm); CrV 50BV30;
- 1/4" (6.3 mm): CrV 50BV30;
- 1/4" (6.3 mm): (155 mm); 72T; CrV 6140;
- 1/4" (6.3 mm): (150 mm); CrV 50BV30

|             |               |    |
|-------------|---------------|----|
| <b>YATO</b> |               |    |
| YT-1445     | 1/4" (6.3 mm) | 10 |



25  
 PCS

- 1/4" (6.3 mm): 3.5, 4, 4.5, 5, 5.5, 6, 7, 8, 9, 10, 11, 12, 13, 14 mm (L=25 mm); CrV 50BV30;
- 1/4" (6.3 mm): 8, 10, 11, 12, 13 mm (L=50 mm); CrV 50BV30;
- 1/4" (6.3 mm): (50.8, 101.6 mm); CrV 50BV30;
- 1/4" (6.3 mm): CrV 50BV30;
- 1/4" (6.3 mm): (152.4 mm); CrV 50BV30;
- 1/4" (6.3 mm): (155 mm); 72T; CrV 6140;
- 1/4" (6.3 mm): (150 mm); CrV 50BV30

|             |               |    |
|-------------|---------------|----|
| <b>YATO</b> |               |    |
| YT-1446     | 1/4" (6.3 mm) | 10 |



38  
 PCS

S2

CrV 6150

- 1/4" (6.3 mm): 3.5, 4, 4.5, 5, 5.5, 6, 7, 8, 9, 10, 11, 12, 13, 14 mm (L=25 mm); CrV 50BV30;
- 1/4" (6.3 mm): (50.8, 101.6 mm); CrV 50BV30;
- 1/4" (6.3 mm): (152.4 mm); CrV 50BV30;
- 1/4" (6.3 mm): (155 mm); 72T; CrV 6140;
- 1/4" (6.3 mm): (150 mm); CrV 50BV30;
- 1/4" (6.3 mm): T10, T15, T20, T25, T30, T40 (L=37 mm); AISI S2 / CrV 6150;
- 1/4" (6.3 mm): PZ1, PZ2 (L=37 mm); AISI S2 / CrV 6150;
- 1/4" (6.3 mm): 3, 4, 5, 6, 8 mm (L=37 mm); AISI S2 / CrV 6150

|             |               |    |
|-------------|---------------|----|
| <b>YATO</b> |               |    |
| YT-1447     | 1/4" (6.3 mm) | 10 |

GB Tool set  
D Sechskant-Steckschlüssel-Satz  
PL Zestaw narzędziowy  
RUS Набор инструмента

CZ Sada nástrčných klíčů a ráčny  
H Dugókulcs készlet racsnis hajtókarral  
RO Rotrușa chei tubulare cu antrenor  
E Juego de herramientas

BMC & COLOR SLEEVE  
XS SIZE



|           |      |               |             |
|-----------|------|---------------|-------------|
| 42<br>PCS | 1/4" | CrV<br>6140   | CrV<br>6150 |
| 6.3<br>mm |      | CrV<br>50BV30 | S2          |
|           |      | 72T           | AS-DRIVE    |



1/4" (6.3 mm): 4, 4.5, 5, 5.5, 6, 7, 8, 9, 10, 11, 12, 13, 14 mm (L=25 mm); CrV 50BV30; 1/4" (6.3 mm): 8, 9, 10, 11, 12, 13 mm (L=50 mm); CrV 50BV30; 1/4" (6.3 mm): (50.8, 101.6 mm); CrV 50BV30; 1/4" (6.3 mm): (150 mm); CrV 6140; 1/4" (6.3 mm): CrV 50BV30; 1/4" (6.3 mm): (152.4 mm); CrV 50BV30; 1/4" (6.3 mm): (155 mm); 72T; CrV 6140; 1/4" (6.3 mm): (150 mm); CrV 50BV30; 1/4" (6.3 mm) x 1/4" (6.3 mm); CrV 6140; 1/4" (6.3 mm): 3, 4, 5 mm (L=25 mm); AISI S2; 1/4" (6.3 mm): PH0, PH1, PH2 (L=25 mm); AISI S2; 1/4" (6.3 mm): PZ0, PZ1, PZ2 (L=25 mm); AISI S2; 1/4" (6.3 mm): 6, 7, 8 mm (L=25 mm); AISI S2; 1.5, 2, 2.5 mm; CrV 6150

|             |               |   |
|-------------|---------------|---|
| <b>YATO</b> |               |   |
| YT-1448     | 1/4" (6.3 mm) | 6 |

GB Tool set  
D Sechskant-Steckschlüssel-Satz  
PL Zestaw narzędziowy  
RUS Набор инструмента

CZ Sada nástrčných klíčů a ráčny  
H Dugókulcs készlet racsnis hajtókarral  
RO Rotrușa chei tubulare cu antrenor  
E Juego de herramientas

BMC & COLOR SLEEVE  
XS SIZE



|           |      |             |               |
|-----------|------|-------------|---------------|
| 56<br>PCS | 1/4" | CrV<br>6140 |               |
| 6.3<br>mm |      | CrV<br>6150 |               |
|           |      | 72T         | CrV<br>50BV30 |
|           |      | AS-DRIVE    | S2            |



1/4" (6.3 mm): 4, 4.5, 5, 5.5, 6, 7, 8, 9, 10, 11, 12, 13 mm (L=25 mm); CrV 50BV30; 1/4" (6.3 mm): 6, 7, 8, 9, 10, 11, 12, 13 mm (L=50 mm); CrV 50BV30; 1/4" (6.3 mm): E4, E5, E6, E7, E8, E10; CrV 50BV30; 1/4" (6.3 mm): (76, 152.4 mm); CrV 50BV30; 1/4" (6.3 mm): (150 mm); CrV 6140; 1/4" (6.3 mm): CrV 50BV30; 1/4" (6.3 mm): (152.4 mm); CrV 50BV30; 1/4" (6.3 mm): (155 mm); 72T; CrV 6140; 1/4" (6.3 mm): (150 mm); CrV 50BV30; 1/4" (6.3 mm) (F) x 3/8" (9.5 mm) (M); CrV 50BV30; 1/4" (6.3 mm): 4, 5.5, 6.5 mm (L=37 mm); AISI S2 / CrV 6150; 1/4" (6.3 mm): PH1, PH2, PH3 (L=37 mm); AISI S2 / CrV 6150; 1/4" (6.3 mm): PZ1, PZ2, PZ3 (L=37 mm); AISI S2 / CrV 6150; 1/4" (6.3 mm): T8, T10, T15, T20, T25, T30, T40 (L=37 mm); AISI S2 / CrV 6150; 1/4" (6.3 mm): 3, 4, 5, 6, 7, 8 mm (L=37 mm); AISI S2 / CrV 6150

|             |               |    |
|-------------|---------------|----|
| <b>YATO</b> |               |    |
| YT-1450     | 1/4" (6.3 mm) | 10 |

GB Socket set  
D Sechskant-Steckschlüssel-Satz  
PL Komplet nasadek długich

RUS Набор насадок  
CZ Sada nástrčných klíčů a ráčny  
H Dugókulcs készlet

RO Trusă chei tubulare  
E Juego de herramientas

9 PCS 3/8" 10 mm CrV 50BV30 AS-DRIVE



METAL CASE & COLOR BOX

PLASTIC HANGER

3/8" (9.5 mm): 8, 10, 11, 12, 13, 14, 16, 17, 19 mm (L=63 mm); CrV 50BV30

3/8" (9.5 mm): 8, 10, 11, 12, 13, 14, 16, 17, 19 mm (L=63 mm); CrV 50BV30

|             |               |    |
|-------------|---------------|----|
| <b>YATO</b> |               |    |
| YT-3861     | 3/8" (9.5 mm) | 20 |

|             |               |    |
|-------------|---------------|----|
| <b>YATO</b> |               |    |
| YT-3855     | 3/8" (9.5 mm) | 10 |

GB Socket set  
D Sechskant-Steckschlüssel-Einsatz  
PL Komplet nasadek z akcesoriami

RUS Набор торцевых головок  
CZ Sada nástrčných klíčů a ráčny  
H Dugókulcs készlet racsnis hajtókarral

RO Trusă chei tubulare cu antrenor  
E Juego de boquillas con accesorios

METAL CASE & COLOR BOX

3/8" CrV 6140 CrV 50BV30  
10 mm 72T AS-DRIVE



15 PCS

3/8" (9.5 mm): 10, 11, 12, 13, 14, 15 (L=28 mm); 17, 19, 21, 22 mm (L=30 mm); CrV 50BV30;  
3/8" (9.5 mm): (76, 152.4 mm); CrV 50BV30;  
3/8" (9.5 mm): 16, 21 mm; CrV 50BV30;  
3/8" (9.5 mm): (200 mm); 72T; CrV 6140

|             |               |    |
|-------------|---------------|----|
| <b>YATO</b> |               |    |
| YT-3863     | 3/8" (9.5 mm) | 10 |



19 PCS

\* - product not for european market  
\* - produkt nieprzeznaczony na rynek europejski

3/8" (9.5 mm): 10, 11, 13, 14, 15 (L=28 mm); 17, 19 mm (L=30 mm); CrV 50BV30;  
3/8" (9.5 mm): 10, 11, 12, 13 mm (L=46 mm); 14, 15, 17, 19 mm (L=63 mm); CrV 50BV30;  
3/8" (9.5 mm): (76 mm); CrV 50BV30; 3/8" (9.5 mm): CrV 50BV30;  
3/8" (9.5 mm): (200 mm); 72T; CrV 6140;  
3/8" (9.5 mm): (215 mm); CrV 50BV30

|             |               |   |
|-------------|---------------|---|
| <b>YATO</b> |               |   |
| YT-3864*    | 3/8" (9.5 mm) | 8 |

GB Tool set  
D Sechskant-Steckschlüssel-Satz  
PL Zestaw narzędziowy

RUS Набор инструмента  
CZ Sada nástrčných klíčů a ráčny  
H Dugókulcs készlet racsnis hajtókarral

RO Rotrușă chei tubulare cu antrenor  
E Juego de herramientas

METAL CASE & COLOR SLEEVE

3/8" CrV 6140 CrV 50BV30  
10 mm 72T AS-DRIVE



15 PCS

3/8" (9.5 mm): 10, 11, 12, 13, 14, 15 (L=28 mm); 17, 19, 21, 22 mm (L=30 mm); CrV 50BV30;  
3/8" (9.5 mm): (76, 152.4 mm); CrV 50BV30;  
3/8" (9.5 mm): 16, 21 mm; CrV 50BV30;  
3/8" (9.5 mm): (200 mm); 72T; CrV 6140

|             |               |    |
|-------------|---------------|----|
| <b>YATO</b> |               |    |
| YT-38631    | 3/8" (9.5 mm) | 10 |

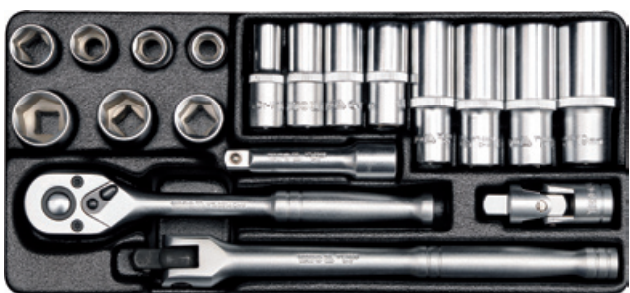

19 PCS

3/8" (9.5 mm): 10, 11, 13, 14, 15 (L=28 mm); 17, 19 mm (L=30 mm); CrV 50BV30;  
3/8" (9.5 mm): 10, 11, 12, 13 mm (L=46 mm); 14, 15, 17, 19 mm (L=63 mm); CrV 50BV30;  
3/8" (9.5 mm): (76 mm); CrV 50BV30; 3/8" (9.5 mm): CrV 50BV30;  
3/8" (9.5 mm): (200 mm); 72T; CrV 6140;  
3/8" (9.5 mm): (215 mm); CrV 50BV30

|             |               |   |
|-------------|---------------|---|
| <b>YATO</b> |               |   |
| YT-38641    | 3/8" (9.5 mm) | 8 |

GB Tool set  
D Sechskant-Steckschlüssel-Satz  
PL Zestaw narzędziowy  
RUS Набор инструмента

CZ Sada nástrčných kľučí a ráčny  
H Dugókulcs készlet racsnis hajtókarral  
RO Rotruşa chei tubulare cu antrenor  
E Juego de herramientas



BMC & COLOR SLEEVE  
XS SIZE



|           |          |               |
|-----------|----------|---------------|
| 22<br>PCS | 3/8"     | CrV<br>6140   |
|           | 10<br>mm | CrV<br>50BV30 |
| 72T       |          | AS-DRIVE      |



3/8" (9.5 mm): 6, 7, 8, 9, 10, 11, 12, 13, 14, 15, 16 mm (L=28 mm); 17, 18, 19, 20, 21, 22 mm (L=30 mm); CrV 50BV30;  
3/8" (9.5 mm); (76, 152.4 mm); CrV 50BV30;  
3/8" (9.5 mm); CrV 50BV30;  
3/8" (9.5 mm); (198 mm); CrV 50BV30;  
3/8" (9.5 mm); (200 mm); 72T; CrV 6140

|   |   |   |
|---|---|---|
| <b>YATO</b>  |  |  |
| YT-3856   | 3/8" (9.5 mm)   | 10  |

GB Tool set  
D Sechskant-Steckschlüssel-Satz  
PL Zestaw narzędziowy  
RUS Набор инструмента

CZ Sada nástrčných kľučí a ráčny  
H Dugókulcs készlet racsnis hajtókarral  
RO Rotruşa chei tubulare cu antrenor  
E Juego de herramientas



BMC & COLOR SLEEVE  
M SIZE



|           |          |               |
|-----------|----------|---------------|
| 58<br>PCS | 3/8"     | CrV<br>6140   |
|           | 10<br>mm | CrV<br>6150   |
|           | AS-DRIVE | CrV<br>50BV30 |
| 72T       |          | S2            |



3/8" (9.5 mm): 6, 7, 8, 9, 10, 11, 12, 13, 14, 15, 16 mm (L=28 mm); 17, 18, 19, 20, 21, 22, 24 mm (L=30 mm); CrV 50BV30; 3/8" (9.5 mm): 8, 10, 11, 12, 13, 14, 15, 17, 19 mm (L=63 mm); CrV 50BV30; 3/8" (9.5 mm): (76, 254 mm); CrV 50BV30; 3/8" (9.5 mm); CrV 50BV30; 3/8" (9.5 mm): 16, 21 mm; CrV 50BV30; 3/8" (9.5 mm); (200 mm); 72T; CrV 6140; 1/2" (12.7 mm) (F) x 3/8" (9.5 mm) (M); CrV 50BV30; 3/8" (9.5 mm): 5.5, 6.5, 8 mm (L=50 mm); AISI S2 / CrV 6150; 3/8" (9.5 mm): PH1, PH2, PH3 (L=50 mm); AISI S2 / CrV 6150; 3/8" (9.5 mm): PZ1, PZ2 (L=50 mm); AISI S2 / CrV 6150; 3/8" (9.5 mm): T10, T15, T20, T25, T30, T40, T45, T50, T55 (L=50 mm); AISI S2 / CrV 6150; 3/8" (9.5 mm): 3, 4, 5, 6, 7, 8, 10 mm (L=50 mm); AISI S2 / CrV 6150

|   |   |   |
|---|---|---|
| <b>YATO</b>  |  |  |
| YT-3857   | 3/8" (9.5 mm)   | 6   |

GB Socket set  
D Sechskant-Steckschlüssel-Satz  
PL Komplet nasadek długich

RUS Набор насадок  
CZ Sada nástrčných klíčů  
H Dugókulcs készlet

RO Trusă chei tubulare  
E Juego de herramientas

10 PCS 1/2" 12.5 mm CrV 50BV30 AS-DRIVE

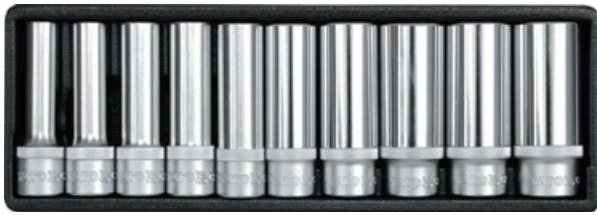

\* - product not for european market  
\* - produkt nieprzeznaczony na rynek europejski

METAL CASE & COLOR BOX



PLASTIC HANGER



1/2" (12.7 mm): 10, 12, 13, 14, 15, 17, 19, 21, 22, 24 mm (L=76 mm); CrV 50BV30

1/2" (12.7 mm): 10, 12, 13, 14, 15, 17, 19, 21, 22, 24 mm (L=76 mm); CrV 50BV30

|             |                |   |
|-------------|----------------|---|
| <b>YATO</b> | Ø              |   |
| YT-1261*    | 1/2" (12.7 mm) | 8 |

|             |                |    |
|-------------|----------------|----|
| <b>YATO</b> | Ø              |    |
| YT-3886     | 1/2" (12.7 mm) | 10 |

GB Socket set  
D Sechskant-Steckschlüssel-Einsatz  
PL Komplet nasadek z akcesoriami

RUS Набор торцевых головок  
CZ Sada nástrčných klíčů a ráčny  
H Dugókulcs készlet racsnis hajtókarral

RO Trusă chei tubulare cu antrenor  
E Juego de boquillas con accesorios

PLASTIC HANGER



12 PCS 1/2" CrV 6140 CrV 50BV30 12.5 mm 72T AS-DRIVE



1/2" (12.7 mm): 10, 11, 12, 13, 14, 15, 17, 19, 21, 24 mm (L=38 mm); CrV 50BV30;

1/2" (12.7 mm): (127 mm); CrV 50BV30;

1/2" (12.7 mm): (255 mm); 72T; CrV 6140

|             |                |    |
|-------------|----------------|----|
| <b>YATO</b> | Ø              |    |
| YT-3882     | 1/2" (12.7 mm) | 10 |

GB Ratchet handle with socket set  
D Sechskant-Steckschlüssel-Satz  
PL Komplet nasadek z grzechotką

RUS Набор насадок  
CZ Sada nástrčných klíčů a ráčny  
H Dugókulcs készlet racsnis hajtókarral

RO Rotrusa chei tubulare cu antrenor  
E Matraca con boquillas

PLASTIC HANGER



19 PCS 1/2" CrV 6140 CrV 50BV30 12.5 mm 72T AS-DRIVE



1/2" (12.7 mm): 8, 9, 10, 11, 12, 13, 14, 15, 16, 17, 19, 21, 22, 23, 24 mm (L=38 mm); 27, 30, 32 mm (L=42 mm); CrV 50BV30;

1/2" (12.7 mm): (255 mm); 72T; CrV 6140

|             |                |   |
|-------------|----------------|---|
| <b>YATO</b> | Ø              |   |
| YT-3868     | 1/2" (12.7 mm) | 6 |

GB Socket set  
D Sechskantenschlüssel-Einsatz  
PL Komplet nasadek z akcesoriami

RUS Набор торцевых головок  
CZ Sada nástrčných klíčů a ráčny  
H Dugókulcs készlet racsnis hajtókarral

RO Trusă chei tubulare cu antrenor  
E Juego de boquillas con accesorios

METAL CASE & COLOR BOX



1/2" CrV 6140 CrV 50BV30 12.5 mm 72T AS-DRIVE



12 PCS

1/2" (12.7 mm): 10, 11, 12, 13, 14, 15, 17, 19, 21, 24 mm (L=38 mm); CrV 50BV30;

1/2" (12.7 mm): (125 mm); CrV 50BV30;

1/2" (12.7 mm): (250 mm); 72T; CrV 6140

|             |                |   |
|-------------|----------------|---|
| <b>YATO</b> | Ø              |   |
| YT-1262     | 1/2" (12.7 mm) | 8 |



18 PCS

1/2" (12.7 mm): 11, 13, 14, 15, 17, 19, 21, 22, 23, 24 mm (L=38 mm); 27, 30, 32 mm (L=42 mm); CrV 50BV30;

1/2" (12.7 mm): (125 mm); CrV 50BV30; 1/2" (12.7 mm): 16, 21 mm; CrV 50BV30;

1/2" (12.7 mm): (250 mm); 72T; CrV 6140;

1/2" (12.7 mm): (460 mm); CrV 50BV30

|             |                |   |
|-------------|----------------|---|
| <b>YATO</b> | Ø              |   |
| YT-1264     | 1/2" (12.7 mm) | 5 |



# Sockets, accessories & sets Klucze nasadowe, akcesoria i zestawy



GB Socket set  
D Sechskantenschlüssel-Einsatz  
PL Komplet nasadek z akcesoriami

RUS Набор торцевых головок  
CZ Sada nástrčných klíčů a ráčny  
H Dugókulcs készlet racsnis hajtókarral

RO Trusă chei tubulare cu antrenor  
E Juego de boquillas con accesorios

METAL CASE & COLOR BOX



1/2" CrV 6140 CrV 50BV30  
12.5 mm 72T AS-DRIVE



23  
PCS

1/2" (12.7 mm): 10, 11, 12, 13, 14, 15, 16, 17, 18, 19, 20, 21, 22, 23, 24 mm (L=38 mm); 27, 30, 32 mm (L=42 mm); CrV 50BV30;  
1/2" (12.7 mm): (125, 250 mm); CrV 50BV30;  
1/2" (12.7 mm); CrV 50BV30;  
1/2" (12.7 mm); (250 mm); CrV 50BV30;  
1/2" (12.7 mm); (250 mm); 72T; CrV 6140

|             |                |   |
|-------------|----------------|---|
| <b>YATO</b> |                |   |
| YT-1265     | 1/2" (12.7 mm) | 5 |



24  
PCS

1/2" (12.7 mm): 10, 11, 12, 13, 14, 15, 16, 17, 18, 19, 20, 21, 22, 23, 24 mm (L=38 mm); 27, 30, 32 mm (L=42 mm); CrV 50BV30;  
1/2" (12.7 mm); (125 mm); CrV 50BV30; 1/2" (12.7 mm); CrV 50BV30;  
1/2" (12.7 mm): 16, 21 mm; CrV 50BV30;  
1/2" (12.7 mm); (250 mm); CrV 50BV30;  
1/2" (12.7 mm); (250 mm); 72T; CrV 6140

|             |                |   |
|-------------|----------------|---|
| <b>YATO</b> |                |   |
| YT-1266     | 1/2" (12.7 mm) | 5 |



25  
PCS

1/2" (12.7 mm): 10, 11, 12, 13, 14, 15, 16, 17, 18, 19, 20, 21, 22, 23, 24 mm (L=38 mm); 27, 30, 32 mm (L=42 mm); CrV 50BV30;  
1/2" (12.7 mm); (50, 125 mm); CrV 50BV30;  
1/2" (12.7 mm): 16, 21 mm; CrV 50BV30;  
1/2" (12.7 mm); (250 mm); CrV 50BV30;  
1/2" (12.7 mm); (250 mm); 72T; CrV 6140;  
1/2" (12.7 mm); (317 mm); CrV 50BV30

|             |                |   |
|-------------|----------------|---|
| <b>YATO</b> |                |   |
| YT-1267     | 1/2" (12.7 mm) | 5 |

GB Tool set  
D Sechskant-Steckschlüssel-Satz  
PL Zestaw narzędziowy

RUS Набор инструмента  
CZ Sada nástrčných klíčů a ráčny  
H Dugókulcs készlet racsnis hajtókarral

RO Rotrusa chei tubulare cu antrenor  
E Juego de herramientas

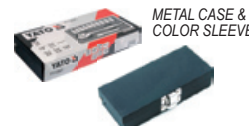

METAL CASE & COLOR SLEEVE

1/2" CrV 6140 CrV 50BV30  
12.5 mm 72T AS-DRIVE



12  
PCS

1/2" (12.7 mm): 10, 11, 12, 13, 14, 15, 17, 19, 21, 24 mm (L=38 mm); CrV 50BV30;  
1/2" (12.7 mm); (125 mm); CrV 50BV30;  
1/2" (12.7 mm); (250 mm); 72T; CrV 6140

|             |                |   |
|-------------|----------------|---|
| <b>YATO</b> |                |   |
| YT-12621    | 1/2" (12.7 mm) | 8 |



18  
PCS

1/2" (12.7 mm): 11, 13, 14, 15, 17, 19, 21, 22, 23, 24 mm (L=38 mm); 27, 30, 32 mm (L=42 mm); CrV 50BV30;  
1/2" (12.7 mm); (125 mm); CrV 50BV30;  
1/2" (12.7 mm): 16, 21 mm; CrV 50BV30;  
1/2" (12.7 mm); (250 mm); 72T; CrV 6140;  
1/2" (12.7 mm); (460 mm); CrV 50BV30

|             |                |   |
|-------------|----------------|---|
| <b>YATO</b> |                |   |
| YT-12641    | 1/2" (12.7 mm) | 5 |

GB Tool set  
D Sechskant-Steckschlüssel-Satz  
PL Zestaw narzędziowy

RUS Набор инструмента  
CZ Sada nástrčných klíčů a ráčny  
H Dugókulcs készlet racsnis hajtókarral

RO Rotrușa chei tubulare cu antrenor  
E Juego de herramientas



1/2" CrV 6140 CrV 50BV30  
12.5 mm 72T AS-DRIVE

2



23 PCS

- 1/2" (12.7 mm): 10, 11, 12, 13, 14, 15, 16, 17, 18, 19, 20, 21, 22, 23, 24 mm (L=38 mm); 27, 30, 32 mm (L=42 mm); CrV 50BV30;
- 1/2" (12.7 mm): (125, 250 mm); CrV 50BV30;
- 1/2" (12.7 mm); CrV 50BV30;
- 1/2" (12.7 mm); (250 mm); CrV 50BV30;
- 1/2" (12.7 mm); (250 mm); 72T; CrV 6140

|             |                |   |
|-------------|----------------|---|
| <b>YATO</b> | ○              |   |
| YT-12651    | 1/2" (12.7 mm) | 5 |



24 PCS

- 1/2" (12.7 mm): 10, 11, 12, 13, 14, 15, 16, 17, 18, 19, 20, 21, 22, 23, 24 mm (L=38 mm); 27, 30, 32 mm (L=42 mm); CrV 50BV30;
- 1/2" (12.7 mm): (125 mm); CrV 50BV30; 1/2" (12.7 mm); CrV 50BV30;
- 1/2" (12.7 mm): 16, 21 mm; CrV 50BV30;
- 1/2" (12.7 mm); (250 mm); CrV 50BV30;
- 1/2" (12.7 mm); (250 mm); 72T; CrV 6140

|             |                |   |
|-------------|----------------|---|
| <b>YATO</b> | ○              |   |
| YT-12661    | 1/2" (12.7 mm) | 5 |



25 PCS

- 1/2" (12.7 mm): 10, 11, 12, 13, 14, 15, 16, 17, 18, 19, 20, 21, 22, 23, 24 mm (L=38 mm); 27, 30, 32 mm (L=42 mm); CrV 50BV30;
- 1/2" (12.7 mm): (50, 125 mm); CrV 50BV30;
- 1/2" (12.7 mm): 16, 21 mm; CrV 50BV30;
- 1/2" (12.7 mm); (250 mm); CrV 50BV30;
- 1/2" (12.7 mm); (250 mm); 72T; CrV 6140;
- 1/2" (12.7 mm); (317 mm); CrV 50BV30

|             |                |   |
|-------------|----------------|---|
| <b>YATO</b> | ○              |   |
| YT-12671    | 1/2" (12.7 mm) | 5 |

GB Tool set  
D Sechskant-Steckschlüssel-Satz  
PL Zestaw narzędziowy

RUS Набор инструмента  
CZ Sada nástrčných klíčů a ráčny  
H Dugókulcs készlet racsnis hajtókarral

RO Rotrușa chei tubulare cu antrenor  
E Juego de herramientas

1/2" CrV 6140 CrV 50BV30  
12.5 mm 72T AS-DRIVE



12 PCS

- 1/2" (12.7 mm): 10, 11, 12, 13, 14, 15, 17, 19, 21, 24 mm (L=38 mm); CrV 50BV30;
- 1/2" (12.7 mm): (127 mm); CrV 50BV30;
- 1/2" (12.7 mm); (255 mm); 72T; CrV 6140

BMC & COLOR SLEEVE XS SIZE



|             |                |    |
|-------------|----------------|----|
| <b>YATO</b> | ○              |    |
| YT-3867     | 1/2" (12.7 mm) | 10 |



18 PCS

- 1/2" (12.7 mm): 11, 13, 14, 15, 17, 19, 21, 22, 23, 24 mm (L=38 mm); 27, 30, 32 mm (L=42 mm); CrV 50BV30;
- 1/2" (12.7 mm); (127 mm); CrV 50BV30;
- 1/2" (12.7 mm): 16, 21 mm; CrV 50BV30;
- 1/2" (12.7 mm); (255 mm); 72T; CrV 6140;
- 1/2" (12.7 mm); (457 mm); CrV 50BV30

BMC & COLOR SLEEVE S SIZE



|             |                |   |
|-------------|----------------|---|
| <b>YATO</b> | ○              |   |
| YT-3870     | 1/2" (12.7 mm) | 6 |

GB Tool set  
D Sechskant-Steckschlüssel-Satz  
PL Zestaw narzędziowy  
RUS Набор инструмента

CZ Sada nástrčných klíčů a ráčny  
H Dugókulcs készlet racsnis hajtókarral  
RO Rotrusa chei tubulare cu antrenor  
E Juego de herramientas

BMC & COLOR SLEEVE  
M SIZE













|            |             |               |
|------------|-------------|---------------|
| 1/2"       | CrV<br>6140 | CrV<br>50BV30 |
| 12.5<br>mm | 72T         | AS-DRIVE      |

2







**20**  
PCS



-  1/2" (12.7 mm): 10, 11, 12, 13, 14, 15, 16, 17, 18, 19, 22, 24 mm (L=38 mm); CrV 50BV30;
-  1/2" (12.7 mm): 13, 17, 19 mm (L=76 mm); CrV 50BV30;
-  1/2" (12.7 mm): (254 mm); CrV 50BV30;
-  3/8" (9.5 mm) (F) x 1/2" (12.7 mm) (M); CrV 50BV30;
-  1/2" (12.7 mm); CrV 50BV30;
-  1/2" (12.7 mm): 16 mm; CrV 50BV30;
-  1/2" (12.7 mm): (255 mm); 72T; CrV 6140

|   |   |   |
|---|---|---|
| <b>YATO</b>  |  |  |
| YT-3869   | 1/2" (12.7 mm)  | 6   |









**23**  
PCS



-  1/2" (12.7 mm): 10, 11, 12, 13, 14, 15, 16, 17, 18, 19, 20, 21, 22, 23, 24 mm (L=38 mm); 27, 30, 32 mm (L=42 mm); CrV 50BV30;
-  1/2" (12.7 mm): (127, 254 mm); CrV 50BV30;
-  1/2" (12.7 mm); CrV 50BV30;
-  1/2" (12.7 mm): (255 mm); CrV 50BV30;
-  1/2" (12.7 mm): (255 mm); 72T; CrV 6140

|   |   |   |
|---|---|---|
| <b>YATO</b>  |  |  |
| YT-3873   | 1/2" (12.7 mm)  | 6   |



**24**  
PCS

-  1/2" (12.7 mm): 10, 11, 12, 13, 14, 15, 16, 17, 18, 19, 20, 21, 22, 23, 24 mm (L=38 mm); 27, 30, 32 mm (L=42 mm); CrV 50BV30;
-  1/2" (12.7 mm): (127 mm); CrV 50BV30;
-  1/2" (12.7 mm); CrV 50BV30;
-  1/2" (12.7 mm): 16, 21 mm; CrV 50BV30;
-  1/2" (12.7 mm): (255 mm); CrV 50BV30;
-  1/2" (12.7 mm): (255 mm); 72T; CrV 6140

|   |   |   |
|---|---|---|
| <b>YATO</b>  |  |  |
| YT-3872   | 1/2" (12.7 mm)  | 6   |

GB Tool set  
 D Sechskant-Steckschlüssel-Satz  
 PL Zestaw narzędziowy  
 RUS Набор инструмента

CZ Sada nástrčných klíčů a ráčny  
 H Dugókulcs készlet racsnis hajtókkal  
 RO Rotrusa chei tubulare cu antrenor  
 E Juego de herramientas

1/2" CrV 6140 CrV 50BV30  
 12.5 mm 72T AS-DRIVE

2



25  
PCS

- 1/2" (12.7 mm): 8, 9, 10, 11, 12, 13, 14, 15, 16, 17, 18, 19, 20, 21, 22, 23, 24 mm (L=38 mm); 27, 30, 32 mm (L=42 mm); CrV 50BV30;
- 1/2" (12.7 mm): (127, 254 mm); CrV 50BV30;
- 3/8" (9.5 mm) (F) x 1/2" (12.7 mm) (M); CrV 50BV30;
- 1/2" (12.7 mm); CrV 50BV30;
- 1/2" (12.7 mm); (255 mm); 72T; CrV 6140

BMC & COLOR SLEEVE  
M SIZE



| YATO    |                |   |
|---------|----------------|---|
| YT-3871 | 1/2" (12.7 mm) | 6 |

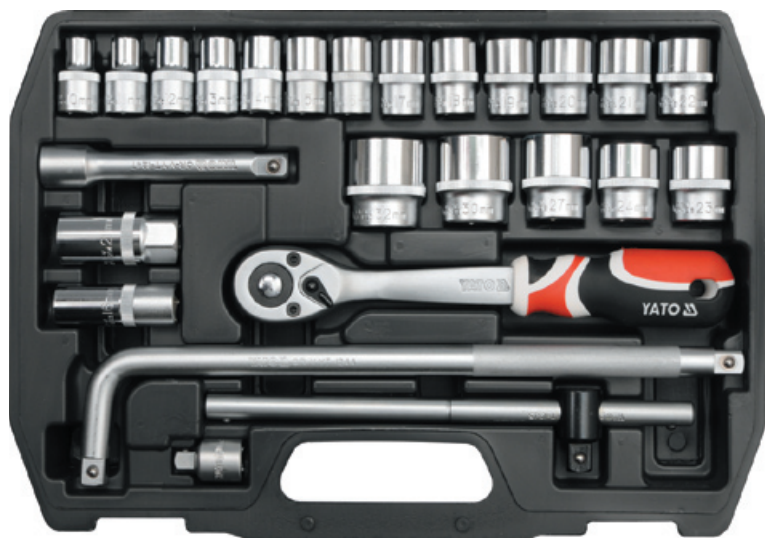

25  
PCS

- 1/2" (12.7 mm): 10, 11, 12, 13, 14, 15, 16, 17, 18, 19, 20, 21, 22, 23, 24 mm (L=38 mm); 27, 30, 32 mm (L=42 mm); CrV 50BV30;
- 1/2" (12.7 mm): (127 mm); CrV 50BV30;
- 1/2" (12.7 mm): 16, 21 mm; CrV 50BV30;
- 1/2" (12.7 mm); (255 mm); CrV 50BV30;
- 1/2" (12.7 mm); (255 mm); 72T; CrV 6140;
- 1/2" (12.7 mm); (317 mm); CrV 50BV30;
- 1/2" (12.7 mm) (F) x 3/8" (9.5 mm) (M); CrV 50BV30

BMC & COLOR SLEEVE  
L SIZE



| YATO    |                |   |
|---------|----------------|---|
| YT-3874 | 1/2" (12.7 mm) | 6 |



27  
PCS

- 1/2" (12.7 mm): 8, 9, 10, 11, 12, 13, 14, 15, 16, 17, 18, 19, 20, 21, 22, 23, 24 mm (L=38 mm); 27, 30, 32 mm (L=42 mm); CrV 50BV30;
- 1/2" (12.7 mm): (127, 254 mm); CrV 50BV30;
- 1/2" (12.7 mm); CrV 50BV30;
- 1/2" (12.7 mm): 16, 21 mm; CrV 50BV30;
- 1/2" (12.7 mm); (255 mm); CrV 50BV30;
- 1/2" (12.7 mm); (255 mm); 72T; CrV 6140

BMC & COLOR SLEEVE  
M SIZE



| YATO    |                |   |
|---------|----------------|---|
| YT-3875 | 1/2" (12.7 mm) | 6 |

GB Tool set  
D Sechskant-Steckschlüssel-Satz  
PL Zestaw narzędziowy

RUS Набор инструмента  
CZ Sada nástrčných klíčů a ráčny  
H Dugókulcs készlet racsnis hajtókarral

RO Rotruşa chei tubulare cu antrenor  
E Juego de herramientas

BMC & COLOR SLEEVE  
M SIZE



|            |             |               |
|------------|-------------|---------------|
| 1/2"       | CrV<br>6140 | CrV<br>50BV30 |
| 12.5<br>mm | 72T         | AS-DRIVE      |

2



**38**  
PCS

- 1/2" (12.7 mm): 10, 11, 12, 13, 14, 15, 16, 17, 18, 19, 20, 21, 22, 23, 24 mm (L=38 mm); 27, 30, 32 mm (L=42 mm); CrV 50BV30;
- 1/2" (12.7 mm): 10, 13, 17, 19 mm (L=76 mm); CrV 50BV30;
- 1/2" (12.7 mm): (127, 254 mm); CrV 50BV30;
- 1/2" (12.7 mm); CrV 50BV30;
- 1/2" (12.7 mm): 16, 21 mm; CrV 50BV30;
- 1/2" (12.7 mm): (255 mm); CrV 50BV30;
- 1/2" (12.7 mm): (255 mm); 72T; CrV 6140;
- 8, 10, 11, 12, 13, 14, 17, 19, 22 mm; CrV

|             |                |   |
|-------------|----------------|---|
| <b>YATO</b> | O              | ☐ |
| YT-3876     | 1/2" (12.7 mm) | 6 |



**46**  
PCS **METRIC & S.A.E.**

- 1/2" (12.7 mm): 8, 9, 10, 11, 12, 13, 14, 15, 16, 17, 18, 19, 20, 21, 22, 23, 24 mm (L=38 mm); 27, 30, 32 mm (L=42 mm); CrV 50BV30;
- 1/2" (12.7 mm): 10, 12, 13, 14, 15, 17, 19 mm (L=76 mm); CrV 50BV30;
- 1/2" (12.7 mm) x 3/8" (9.5 mm); 1/2" (12.7 mm) x 7/16" (11.1 mm); 1/2" (12.7 mm) x 1/2" (12.7 mm); 1/2" (12.7 mm) x 9/16" (14.3 mm); 1/2" (12.7 mm) x 5/8" (15.9 mm); 1/2" (12.7 mm) x 11/16" (17.5 mm); 1/2" (12.7 mm) x 3/4" (19.0 mm); 1/2" (12.7 mm) x 13/16" (20.6 mm); 1/2" (12.7 mm) x 7/8" (22.2 mm); 1/2" (12.7 mm) x 15/16" (23.8 mm); 1/2" (12.7 mm) x 1" (25.4 mm); CrV 50BV30;
- 1/2" (12.7 mm): (127, 254 mm); CrV 50BV30;
- 3/8" (9.5 mm) (F) x 1/2" (12.7 mm) (M); CrV 50BV30;
- 1/2" (12.7 mm): CrV 50BV30;
- 1/2" (12.7 mm): (255 mm); 72T; CrV 6140;
- 1/2" (12.7 mm): (250 mm); CrV 50BV30

|             |                |   |
|-------------|----------------|---|
| <b>YATO</b> | O              | ☐ |
| YT-3877     | 1/2" (12.7 mm) | 6 |

GB Tool set  
D Sechskant-Steckschlüssel-Satz  
PL Zestaw narzędziowy

RUS Набор инструмента  
CZ Sada nástrčných klíčů a ráčny  
H Dugókulcs készlet racsni hajtókarral

RO Rotrușa chei tubulare cu antrenor  
E Juego de herramientas

BMC & COLOR SLEEVE  
L SIZE



|          |            |
|----------|------------|
| 1/2"     | 1/4"       |
| 12.5 mm  | 6.3 mm     |
| CrV 6140 | CrV 50BV30 |
| S2       | AS-DRIVE   |
| 72T      |            |

2



77 PCS CrV 6150

1/2" (12.7 mm): 10, 11, 12, 13, 14, 15, 17, 19, 22, 24 mm (L=38 mm); 27, 30, 32 mm (L=42 mm); 1/4" (6.3 mm): 4, 5, 6, 7, 8, 9, 10, 11, 12 mm (L=25 mm); CrV 50BV30: 1/2" (12.7 mm): (127, 254 mm); 1/4" (6.3 mm): (76, 101.6 mm); CrV 50BV30: 1/2" (12.7 mm), 1/4" (6.3 mm); CrV 50BV30: 1/2" (12.7 mm): 16, 21 mm; CrV 50BV30: 1/2" (12.7 mm); (255 mm); 1/4" (6.3 mm): (155 mm); 72T; CrV 6140: 1/4" (6.3 mm) x 1/4" (6.3 mm); CrV 6140: 1/4" (6.3 mm) x 1/4" (6.3 mm) (L=25 mm); CrV 6140: 1/4" (6.3 mm): 3, 4, 5, 5, 7 mm (L=25 mm); ALISI S2: 1/4" (6.3 mm): PH0, PH1, PH2, PH3 (L=25 mm); ALISI S2: 1/4" (6.3 mm): PZ1, PZ2, PZ3 (L=25 mm); ALISI S2: 1/4" (6.3 mm): T10, T15, T20, T25, T30 (L=25 mm); ALISI S2: 1/4" (6.3 mm): 2, 3, 4, 5, 6 mm (L=25 mm); ALISI S2: 7, 8, 9, 10, 11, 12, 13, 14, 15, 17, 19 mm; CrV: 8x9, 10x11, 12x13, 14x15 mm; CrV 6140: 1.5, 2, 2.5, 5, 6, 8, 10 mm; CrV 6150

| YATO    | 1/2" (12.7 mm) | 1/4" (6.3 mm) |   |
|---------|----------------|---------------|---|
| YT-3878 |                |               | 2 |



79 PCS CrV 55 CrV 60 CrMo SK5 SVCM 55

1/2" (12.7 mm): 10, 11, 12, 13, 14, 16, 17, 19, 22, 24, 26 mm (L=38 mm); 27, 30, 32 mm (L=42 mm); 1/4" (6.3 mm): 5, 6, 7, 8, 9, 10, 11, 12, 13 mm (L=25 mm); CrV 50BV30: 1/2" (12.7 mm): 10, 11, 12, 13, 14, 17, 19 mm (L=76 mm); CrV 50BV30: 1/2" (12.7 mm); (127 mm); 1/4" (6.3 mm): (50.8 mm); CrV 50BV30: 1/2" (12.7 mm); CrV 50BV30: 1/2" (12.7 mm): 16, 21 mm; CrV 50BV30: 1/2" (12.7 mm); (255 mm); 1/4" (6.3 mm): (155 mm); 72T; CrV 6140: 1/4" (6.3 mm): (150 mm); CrV 50BV30: 1/2" (12.7 mm): (420 mm); CrV 50BV30: 2.0x40, 2.4x75 mm; S2: 3.0x75, 4.0x100, 6.5x150, 8.0x150 mm; SVCM55: PH0x75 mm; S2: PH1x75, PH2x100 mm; SVCM55: 180 mm; CrV 55: 160 mm; CrV 55: 160, 200 mm; CrV 55: 250 mm; CrV: 300 g; 300 mm; 180 mm; CrMo: 120 mm; CrV 60: SK5: 2.5, 3, 4, 5, 6, 8, 10 mm; CrV

| YATO    | 1/2" (12.7 mm) | 1/4" (6.3 mm) |   |
|---------|----------------|---------------|---|
| YT-3891 |                |               | 2 |

# Socket, accessories & sets Klucze nasadowe, akcesoria i zestawy



GB Tool set  
D Sechskant-Steckschlüssel-Satz  
PL Zestaw narzędziowy

RUS Набор инструмента  
CZ Sada nástrčných klíčů a ráčny  
H Dugókulcs készlet racsnis hajtókarral

RO Rotruşa chei tubulare cu antrenor  
E Juego de herramientas

BMC & COLOR SLEEVE  
L SIZE



|          |            |
|----------|------------|
| 1/2"     | 1/4"       |
| 12.5 mm  | 6.3 mm     |
| CrV 6140 | CrV 50BV30 |
| AS-DRIVE | S2         |
| 72T      |            |

2



\* - product not for european market  
\* - produkt nieprzeznaczony na rynek europejski

|        |        |        |      |     |          |
|--------|--------|--------|------|-----|----------|
| 79 PCS | CrV 55 | CrV 60 | CrMo | SK5 | SVC M 55 |
|--------|--------|--------|------|-----|----------|

1/2" (12.7 mm): 10, 11, 12, 13, 14, 16, 17, 19, 22, 24, 26 mm (L=38 mm); 27, 30, 32 mm (L=42 mm), 1/4" (6.3 mm): 5, 6, 7, 8, 9, 10, 11, 12, 13 mm (L=25 mm); CrV 50BV30: 1/2" (12.7 mm): (127 mm), 1/4" (6.3 mm): (50.8 mm); CrV 50BV30: 1/2" (12.7 mm): CrV 50BV30; 1/2" (12.7 mm): 16, 21 mm; CrV 50BV30: 1/2" (12.7 mm): (150 mm); (255 mm), 1/4" (6.3 mm): (155 mm); 72T; CrV 6140: 1/4" (6.3 mm): (150 mm); CrV 50BV30: 1/2" (12.7 mm): (420 mm); CrV 50BV30: 2.0x40, 2.4x75 mm; S2: 3.0x75, 4.0x100, 6.5x150, 8.0x150 mm; SVC M55: PH0x75 mm; S2: PH1x75, PH2x100 mm; SVC M55: 180 mm; CrV 55: 160 mm; CrV 55: 160, 200 mm; CrV 55: 250 mm; CrV: 300 g; 300 mm; 180 mm; CrMo: 120 mm; CrV 60: SK5: 2.5, 3, 4, 5, 6, 8, 10 mm; CrV

| YATO     | 1/2" (12.7 mm) | 1/4" (6.3 mm) |   |
|----------|----------------|---------------|---|
| YT-3892* |                |               | 2 |



|        |          |
|--------|----------|
| 82 PCS | CrV 6150 |
|--------|----------|

1/2" (12.7 mm): 14, 15, 16, 17, 18, 19, 20, 22, 24 mm (L=38 mm); 27, 30, 32 mm (L=42 mm), 1/4" (6.3 mm): 4, 4.5, 5, 5.5, 6, 7, 8, 9, 10, 11, 12, 13, 14 mm (L=25 mm); CrV 50BV30: 1/2" (12.7 mm): (127, 254 mm), 1/4" (6.3 mm): (50.8, 101.6 mm); CrV 50BV30: 3/8" (9.5 mm) (F) x 1/2" (12.7 mm) (M); CrV 50BV30: 1/4" (6.3 mm): (150 mm); CrV 6140: 1/2" (12.7 mm), 1/4" (6.3 mm); CrV 50BV30: 1/2" (12.7 mm): 16, 21 mm; CrV 50BV30: 1/4" (6.3 mm): (152.4 mm); CrV 50BV30: 1/2" (12.7 mm): (255 mm), 1/4" (6.3 mm): (155 mm); 72T; CrV 6140: 1/4" (6.3 mm): (150 mm); CrV 50BV30: 1/2" (12.7 mm) x 5/16" (7.9 mm); CrV 6140: 1/4" (6.3 mm) x 1/4" (6.3 mm); CrV 6140: 5/16" (7.9 mm): 8, 10, 12 mm (L=30 mm); AISI S2: 5/16" (7.9 mm): PH3, PH4 (L=30 mm); AISI S2: 5/16" (7.9 mm): PZ3, PZ4 (L=30 mm); AISI S2: 5/16" (7.9 mm): T40, T45, T50, T55 (L=30 mm); AISI S2: 5/16" (7.9 mm): 8, 10, 12, 14 mm (L=30 mm); AISI S2: 1/4" (6.3 mm): 4, 5.5, 7 mm (L=37 mm); AISI S2 / CrV 6150: 1/4" (6.3 mm): PH1, PH2 (L=37 mm); AISI S2 / CrV 6150: 1/4" (6.3 mm): PZ1, PZ2 (L=37 mm); AISI S2 / CrV 6150: 1/4" (6.3 mm): T8, T10, T15, T20, T25, T30 (L=37 mm); AISI S2 / CrV 6150: 1/4" (6.3 mm): 3, 4, 5, 6 mm (L=37 mm); AISI S2 / CrV 6150: 8, 10, 11, 12, 13, 14, 17, 19, 22 mm; CrV

| YATO    | 1/2" (12.7 mm) | 1/4" (6.3 mm) |   |
|---------|----------------|---------------|---|
| YT-1269 |                |               | 4 |

GB Tool set  
D Sechskant-Steckschlüssel-Satz  
PL Zestaw narzędziowy

RUS Набор инструмента  
CZ Sada nástrčných klíčů a ráčny  
H Dugókulcs készlet racsnis hajtókarral

RO Rotrușa chei tubulare cu antrenor  
E Juego de herramientas

BMC & COLOR SLEEVE  
L SIZE



|            |          |
|------------|----------|
| 1/2"       | 1/4"     |
| 12.5 mm    | 6.3 mm   |
| CrV 6140   | CrV 6150 |
| CrV 50BV30 | S2       |
| AS-DRIVE   | 72T      |

2



**94**  
PCS

1/2" (12.7 mm): 10, 11, 12, 13, 14, 15, 16, 17, 18, 19, 20, 21, 22, 23, 24 mm (L=38 mm); 27, 30, 32 mm (L=42 mm); CrV 50BV30, 1/4" (6.3 mm): 4, 4.5, 5, 5.5, 6, 7, 8, 9, 10, 11, 12, 13, 14 mm (L=25 mm); CrV 50BV30: 1/2" (12.7 mm): 14, 15, 17, 19 mm (L=76 mm), 1/4" (6.3 mm): 6, 7, 8, 9, 10, 11, 12, 13 mm (L=50 mm); CrV 50BV30: 1/2" (12.7 mm): (127, 254 mm), 1/4" (6.3 mm); (50.8, 101.6 mm); CrV 50BV30: 3/8" (9.5 mm) (F) x 1/2" (12.7 mm) (M); CrV 50BV30: 1/4" (6.3 mm): (150 mm); CrV 6140: 1/2" (12.7 mm), 1/4" (6.3 mm); CrV 50BV30: 1/2" (12.7 mm): 16, 21 mm; CrV 50BV30: 1/4" (6.3 mm); (152.4 mm); CrV 50BV30: 1/2" (12.7 mm); (255 mm), 1/4" (6.3 mm); (155 mm); 72T; CrV 6140: 1/4" (6.3 mm); (150 mm); CrV 50BV30: 1/2" (12.7 mm) x 5/16" (7.9 mm); CrV 6140: 1/4" (6.3 mm) x 1/4" (6.3 mm) (L=25 mm); CrV 6140: 5/16" (7.9 mm): 8, 10, 12 mm (L=30 mm); AISI S2: 5/16" (7.9 mm): PH3, PH4 (L=30 mm); AISI S2: 5/16" (7.9 mm): PZ3, PZ4 (L=30 mm); AISI S2: 5/16" (7.9 mm): T40, T45, T50, T55 (L=30 mm); AISI S2: 5/16" (7.9 mm): 8, 10, 12, 14 mm (L=30 mm); AISI S2: 1/4" (6.3 mm): 4, 5, 5, 7 mm (L=37 mm); AISI S2 / CrV 6150: 1/4" (6.3 mm): PH1, PH2 (L=37 mm); AISI S2 / CrV 6150: 1/4" (6.3 mm): PZ1, PZ2 (L=37 mm); AISI S2 / CrV 6150: 1/4" (6.3 mm): T8, T10, T15, T20, T25, T30 (L=37 mm); AISI S2 / CrV 6150: 1/4" (6.3 mm): 3, 4, 5, 6 mm (L=37 mm); AISI S2 / CrV 6150: 1.5, 2.0, 2.5 mm; CrV 6150

| YATO    | 1/2" (12.7 mm) | 1/4" (6.3 mm) |   |
|---------|----------------|---------------|---|
| YT-1268 |                |               | 4 |



**108**  
PCS

1/2" (12.7 mm): 10, 11, 12, 13, 14, 15, 16, 17, 18, 19, 20, 21, 22, 24 mm (L=38 mm); 27, 30, 32 mm (L=42 mm), 1/4" (6.3 mm): 4, 4.5, 5, 5.5, 6, 7, 8, 9, 10, 11, 12, 13, 14 mm (L=25 mm); CrV 50BV30: 1/2" (12.7 mm): 14, 15, 17, 19, 22 mm (L=76 mm), 1/4" (6.3 mm): 6, 7, 8, 9, 10, 11, 12, 13 mm (L=50 mm); CrV 50BV30: 1/2" (12.7 mm): E10, E11, E12, E14, E16, E18, E20, E24, 1/4" (6.3 mm): E4, E5, E6, E7, E8; CrV 50BV30: 1/2" (12.7 mm): (127, 254 mm), 1/4" (6.3 mm); (50.8, 101.6 mm); CrV 50BV30: 3/8" (9.5 mm) (F) x 1/2" (12.7 mm) (M); CrV 50BV30: 1/2" (12.7 mm), 1/4" (6.3 mm); CrV 50BV30: 1/2" (12.7 mm): 16, 21 mm; CrV 50BV30: 1/4" (6.3 mm); (152.4 mm); CrV 50BV30: 1/2" (12.7 mm); (255 mm), 1/4" (6.3 mm); (155 mm); 72T; CrV 6140: 1/4" (6.3 mm); (150 mm); CrV 50BV30: 1/2" (12.7 mm) x 5/16" (7.9 mm); CrV 6140: 5/16" (7.9 mm): 8, 10, 12 mm (L=30 mm); AISI S2: 5/16" (7.9 mm): PH3, PH4 (L=30 mm); AISI S2: 5/16" (7.9 mm): PZ3, PZ4 (L=30 mm); AISI S2: 5/16" (7.9 mm): T40, T45, T50, T55, T60 (L=30 mm); AISI S2: 5/16" (7.9 mm): 7, 8, 10, 12, 14 mm (L=30 mm); AISI S2: 1/4" (6.3 mm): 4, 5, 5, 6, 5 mm (L=37 mm); AISI S2 / CrV 6150: 1/4" (6.3 mm): PH1, PH2 (L=37 mm); AISI S2 / CrV 6150: 1/4" (6.3 mm): PZ1, PZ2 (L=37 mm); AISI S2 / CrV 6150: 1/4" (6.3 mm): T8, T10, T15, T20, T25, T27, T30 (L=37 mm); AISI S2 / CrV 6150: 1/4" (6.3 mm): 3, 4, 5, 6 mm (L=37 mm); AISI S2 / CrV 6150: 1.5, 2.0, 2.5 mm; CrV 6150

| YATO    | 1/2" (12.7 mm) | 1/4" (6.3 mm) |   |
|---------|----------------|---------------|---|
| YT-3879 |                |               | 2 |



GB Tool set  
D Sechskant-Steckschlüssel-Satz  
PL Zestaw narzędziowy

RUS Набор инструмента  
CZ Sada nástrčných klíčů a ráčny  
H Dugókulcs készlet racsnis hajtókarral

RO Rotruşa chei tubulare cu antrenor  
E Juego de herramientas

BMC & COLOR SLEEVE  
XL SIZE



|            |          |
|------------|----------|
| 1/2"       | 1/4"     |
| 12.5 mm    | 6.3 mm   |
| CrV 6140   | CrV 6150 |
| CrV 50BV30 | S2       |
| CrV 55     | SVC M 55 |
| AS-DRIVE   | 72T      |

2



109  
PCS

1/2" (12.7 mm): 12, 13, 14, 15, 16, 17, 18, 19, 20, 21, 22, 24 mm (L=38 mm); 27, 30, 32 mm (L=42 mm), 1/4" (6.3 mm): 4, 4.5, 5, 5.5, 6, 7, 8, 9, 10, 11, 12, 13, 14 mm (L=25 mm); CrV 50BV30: 1/2" (12.7 mm): 10, 12, 13, 14, 17, 19 mm (L=76 mm), 1/4" (6.3 mm): 4, 5, 6, 7, 8, 9 mm (L=50 mm); CrV 50BV30: 1/2" (12.7 mm): E10, E12, E14, E16, E18, E20, E22, E24; CrV 50BV30: 1/2" (12.7 mm): (254 mm), 1/4" (6.3 mm): (152.4 mm); CrV 50BV30: 3/8" (9.5 mm) (F) x 1/2" (12.7 mm) (M), 3/8" (9.5 mm) (F) x 1/4" (6.3 mm) (M); CrV 50BV30: 1/2" (12.7 mm), 1/4" (6.3 mm); CrV 50BV30: 1/2" (12.7 mm): 16, 21 mm; CrV 50BV30: 1/2" (12.7 mm): (255 mm), 1/4" (6.3 mm): (155 mm); 72T: CrV 6140: 1/4" (6.3 mm): (150 mm); CrV 50BV30: 1/4" (6.3 mm): 4.0, 5.5, 6.5 mm (L=37 mm); AISI S2 / CrV 6150: 1/4" (6.3 mm): PH1, PH2, PH3 (L=37 mm); AISI S2 / CrV 6150: 1/4" (6.3 mm): PZ2, PZ3 (L=37 mm); AISI S2 / CrV 6150: 1/4" (6.3 mm): T8, T10, T15, T20, T25 (L=37 mm); AISI S2 / CrV 6150: 1/4" (6.3 mm): T10, T15, T20, T25, T40 (L=37 mm); AISI S2 / CrV 6150: 1/4" (6.3 mm): 3, 4, 5, 6 mm (L=37 mm); AISI S2 / CrV 6150: 8, 9, 10, 11, 12, 13, 14, 15, 16, 17, 18, 19 mm; CrV: 8x9, 10x11, 12x13, 14x15 mm; CrV 6140: 8x10, 12x13, 17x19 mm; CrV 6140: 3x75, 4x100, 6.5x150, PH1x75, PH2x100, PH3x150 mm; SVC M55: 180 mm; CrV 55: 160 mm; CrV 55: 300 g

| YATO    | 1/2" (12.7 mm) | 1/4" (6.3 mm) |   |
|---------|----------------|---------------|---|
| YT-3889 |                |               | 2 |



122  
PCS

1/2" (12.7 mm): 12, 13, 14, 15, 16, 17, 18, 19, 20, 21, 22, 24 mm (L=38 mm); 27, 30, 32 mm (L=42 mm), 1/4" (6.3 mm): 4, 4.5, 5, 5.5, 6, 7, 8, 9, 10, 11, 12, 13, 14 mm (L=25 mm); CrV 50BV30: 1/2" (12.7 mm): 10, 12, 13, 14, 17, 19 mm (L=76 mm), 1/4" (6.3 mm): 4, 5, 6, 7, 8, 9 mm (L=50 mm); CrV 50BV30: 1/2" (12.7 mm): E10, E12, E14, E16, E18, E20, E22, E24; CrV 50BV30: 1/2" (12.7 mm): (254 mm), 1/4" (6.3 mm): (152.4 mm); CrV 50BV30: 3/8" (9.5 mm) (F) x 1/2" (12.7 mm) (M), 3/8" (9.5 mm) (F) x 1/4" (6.3 mm) (M); CrV 50BV30: 1/2" (12.7 mm), 1/4" (6.3 mm); CrV 50BV30: 1/2" (12.7 mm): 16, 21 mm; CrV 50BV30: 1/2" (12.7 mm): (255 mm), 1/4" (6.3 mm): (155 mm); 72T: CrV 6140: 1/4" (6.3 mm): (150 mm); CrV 50BV30: 1/4" (6.3 mm) x 1/4" (6.3 mm); CrV 6140: 1/4" (6.3 mm): 3, 4, 5, 6 mm (L=25 mm); AISI S2: 1/4" (6.3 mm): PH0, PH1, PH2 (L=25 mm); AISI S2: 1/4" (6.3 mm): PZ0, PZ1, PZ2 (L=25 mm); AISI S2: 1/4" (6.3 mm): 4.0, 5.5, 6.5 mm (L=37 mm); AISI S2 / CrV 6150: 1/4" (6.3 mm): PH1, PH2, PH3 (L=37 mm); AISI S2 / CrV 6150: 1/4" (6.3 mm): PZ2, PZ3 (L=37 mm); AISI S2 / CrV 6150: 1/4" (6.3 mm): T8, T10, T15, T20, T25 (L=37 mm); AISI S2 / CrV 6150: 1/4" (6.3 mm): T10, T15, T20, T25, T40 (L=37 mm); AISI S2 / CrV 6150: 1/4" (6.3 mm): 3, 4, 5, 6 mm (L=37 mm); AISI S2 / CrV 6150: 8, 9, 10, 11, 12, 13, 14, 15, 16, 17, 18, 19 mm; CrV: 4x100, 6.5x150, PH2x100, PH3x150 mm; SVC M55: 180 mm; CrV 55: 160 mm; CrV 55: 250 mm; CrV: 300 g; 2, 2.5, 3, 4, 5, 6, 7, 8, 10 mm: CrV 6150

| YATO    | 1/2" (12.7 mm) | 1/4" (6.3 mm) |   |
|---------|----------------|---------------|---|
| YT-3890 |                |               | 2 |

GB Tool set  
D Sechskant-Steckschlüssel-Satz  
PL Zestaw narzędziowy

RUS Набор инструмента  
CZ Sada nástrčných klíčů a ráčny  
H Dugókulcs készlet racsnis hajtókarral

RO Rotrușa chei tubulare cu antrenor  
E Juego de herramientas

BMC & COLOR SLEEVE  
XL SIZE



|            |          |        |
|------------|----------|--------|
| 1/2"       | 3/8"     | 1/4"   |
| 12.5 mm    | 10 mm    | 6.3 mm |
| CrV 6140   | CrV 6150 |        |
| CrV 50BV30 | S2       |        |
| AS-DRIVE   | 72T      |        |

2



**111**  
PCS

1/2" (12.7 mm): 14, 15, 16, 17, 18, 19, 20, 21, 22, 23, 24 mm (L=38 mm); 27, 30, 32 mm (L=42 mm); 3/8" (9.5 mm): 9, 10, 11, 12, 13, 14, 15, 16 mm (L=28 mm); 17, 18, 19 mm (L=30 mm); 1/4" (6.3 mm): 3.5, 4, 4.5, 5, 5.5, 6, 7, 8, 9, 10, 11, 12, 13 mm (L=25 mm); CrV 50BV30: 1/2" (12.7 mm): (127, 254 mm); 3/8" (9.5 mm): (76, 152.4 mm); 1/4" (6.3 mm): (50.8, 152.4 mm); CrV 50BV30: 3/8" (9.5 mm) (F) x 1/2" (12.7 mm) (M), 1/2" (12.7 mm) (F) x 3/8" (9.5 mm) (M), 3/8" (9.5 mm) (F) x 1/4" (6.3 mm) (M); CrV 50BV30: 1/2" (12.7 mm); 3/8" (9.5 mm); 1/4" (6.3 mm); CrV 50BV30: 1/2" (12.7 mm): 16, 21 mm; 3/8" (9.5 mm): 16, 21 mm; CrV 50BV30: 1/2" (12.7 mm); (255 mm); 3/8" (9.5 mm): (200 mm); 1/4" (6.3 mm): (155 mm); 72T; CrV 6140: 1/4" (6.3 mm): (150 mm); CrV 50BV30: 1/2" (12.7 mm) x 5/16" (7.9 mm); 3/8" (9.5 mm) x 5/16" (7.9 mm); CrV 6140: 5/16" (7.9 mm); 6, 6.5, 8 mm (L=30 mm); AISI S2: 5/16" (7.9 mm); PH2, PH3 (L=30 mm); AISI S2: 5/16" (7.9 mm); PZ2, PZ3 (L=30 mm); AISI S2: 5/16" (7.9 mm); T27, T30, T35, T40, T45 (L=30 mm); AISI S2: 5/16" (7.9 mm); 5.5, 6, 6.5 mm (L=30 mm); AISI S2: 1/4" (6.3 mm): 4, 5.5, 6.5 mm (L=37 mm); AISI S2 / CrV 6150: 1/4" (6.3 mm); PH1, PH2 (L=37 mm); AISI S2 / CrV 6150: 1/4" (6.3 mm); PZ1, PZ2 (L=37 mm); AISI S2 / CrV 6150: 1/4" (6.3 mm); T8, T10, T15, T20, T25 (L=37 mm); AISI S2 / CrV 6150: 1/4" (6.3 mm); T10, T15, T20, T25, T40 (L=37 mm); AISI S2 / CrV 6150: 1/4" (6.3 mm); 3, 4, 5, 6 mm (L=37 mm); AISI S2 / CrV 6150: 8, 9, 10, 11, 12, 13, 14, 15, 16, 17, 18, 19 mm; CrV: 1.5, 2, 2.5 mm; CrV 6150

| YATO    | 1/2" (12.7 mm) | 3/8" (9.5 mm) | 1/4" (6.3 mm) | 2 |
|---------|----------------|---------------|---------------|---|
| YT-3883 |                |               |               |   |



**120**  
PCS  
METRIC & S.A.E.

1/2" (12.7 mm): 20, 21, 22, 24 mm (L=38 mm); 27, 30, 32 mm (L=42 mm); 3/8" (9.5 mm): 9, 10, 11, 12, 13, 14, 15, 16 mm (L=28 mm); 17, 18, 19 mm (L=30 mm); 1/4" (6.3 mm): 4, 5, 6, 7, 8, 9, 10, 11, 12, 13 mm (L=25 mm); CrV 50BV30: 3/8" (9.5 mm): 13, 14, 15, 17 mm (L=63 mm); 1/4" (6.3 mm): 8, 9, 10, 12 mm (L=50 mm); CrV 50BV30: 1/2" (12.7 mm) x 15/16" (23.8 mm); 1/2" (12.7 mm) x 1" (25.4 mm); 1/2" (12.7 mm) x 1-1/16" (27.0 mm); 1/2" (12.7 mm) x 1-1/4" (31.8 mm); 3/8" (9.5 mm) x 3/8" (9.5 mm); 3/8" (9.5 mm) x 7/16" (11.1 mm); 3/8" (9.5 mm) x 1/2" (12.7 mm); 3/8" (9.5 mm) x 9/16" (14.3 mm); 3/8" (9.5 mm) x 5/8" (15.9 mm); 3/8" (9.5 mm) x 11/16" (17.5 mm); 3/8" (9.5 mm) x 3/4" (19.0 mm); 3/8" (9.5 mm) x 13/16" (20.6 mm); 3/8" (9.5 mm) x 7/8" (22.2 mm); 1/4" (6.3 mm) x 5/32" (4.0 mm); 1/4" (6.3 mm) x 3/16" (4.8 mm); 1/4" (6.3 mm) x 7/32" (5.6 mm); 1/4" (6.3 mm) x 1/4" (6.3 mm); 1/4" (6.3 mm) x 9/32" (7.1 mm); 1/4" (6.3 mm) x 5/16" (7.9 mm); 1/4" (6.3 mm) x 11/32" (8.7 mm); 1/4" (6.3 mm) x 3/8" (9.5 mm); 1/4" (6.3 mm) x 7/16" (11.1 mm); 1/4" (6.3 mm) x 1/2" (12.7 mm); CrV 50BV30: 1/2" (12.7 mm): 17, 19, 21, 23 mm; CrV 50BV30: 3/8" (9.5 mm): E8, E10, E11, E12, E14, E16, E18, E20; CrV 50BV30: 1/2" (12.7 mm): (127, 254 mm); 3/8" (9.5 mm): (76, 152.4 mm); 1/4" (6.3 mm): (50.8 mm); CrV 50BV30: 1/2" (12.7 mm); 3/8" (9.5 mm); 1/4" (6.3 mm); CrV 50BV30: 3/8" (9.5 mm); 16, 21 mm; CrV 50BV30: 1/2" (12.7 mm); (255 mm); 3/8" (9.5 mm); (200 mm); 1/4" (6.3 mm); (155 mm); 72T; CrV 6140: 1/4" (6.3 mm); (150 mm); CrV 50BV30: 1/4" (6.3 mm) x 1/4" (6.3 mm); CrV 6140: 1/4" (6.3 mm); T10, T15, T20, T25, T27, T30, T40 (L=25 mm); AISI S2: 3/8" (9.5 mm); 5.5, 6.5 mm (L=50 mm); AISI S2 / CrV 6150: 3/8" (9.5 mm); PH1, PH2 (L=50 mm); AISI S2 / CrV 6150: 3/8" (9.5 mm); PZ1, PZ2 (L=50 mm); AISI S2 / CrV 6150: 3/8" (9.5 mm); T20, T30, T40, T45, T50, T55, T60 (L=50 mm); AISI S2 / CrV 6150: 3/8" (9.5 mm); 3, 4, 5, 6 mm (L=50 mm); AISI S2 / CrV 6150: 8, 9, 10, 11, 12, 13, 14, 17, 18, 19 mm; CrV

| YATO    | 1/2" (12.7 mm) | 3/8" (9.5 mm) | 1/4" (6.3 mm) | 2 |
|---------|----------------|---------------|---------------|---|
| YT-3880 |                |               |               |   |

# Socket, accessories & sets Klucze nasadowe, akcesoria i zestawy



GB Tool set  
D Sechskant-Steckschlüssel-Satz  
PL Zestaw narzędziowy

RUS Набор инструмента  
CZ Sada nástrčných klíčů a ráčny  
H Dugókulcs készlet racsnis hajtókarral

RO Rotrusa chei tubulare cu antrenor  
E Juego de herramientas

BMC & COLOR SLEEVE  
XXL SIZE



|            |          |        |
|------------|----------|--------|
| 1/2"       | 3/8"     | 1/4"   |
| 12.5 mm    | 10 mm    | 6.3 mm |
| CrV 6140   | CrV 6150 |        |
| CrV 50BV30 | S2       |        |
| AS-DRIVE   | 72T      |        |



128  
PCS

1/2" (12.7 mm): 14, 15, 16, 17, 18, 19, 20, 21, 22, 24 mm (L=38 mm); 27, 30, 32 mm (L=42 mm), 3/8" (9.5 mm): 10, 11, 12, 13, 14, 15, 16 mm (L=28 mm); 17, 18 mm (L=30 mm), 1/4" (6.3 mm): 6, 7, 8, 9, 10, 11, 12, 13 mm (L=25 mm); CrV 50BV30: 1/2" (12.7 mm): 17, 18, 19, 22 mm (L=76 mm), 3/8" (9.5 mm): 8, 10, 12, 13, 14, 15 mm (L=63 mm), 1/4" (6.3 mm): 6, 7, 8, 10, 12, 13 mm (L=50 mm); CrV 50BV30: 1/2" (12.7 mm): 17, 19, 21, 22 mm; CrV 50BV30: 3/8" (9.5 mm): E8, E10, E11, E12, E14, E16; CrV 50BV30: 1/2" (12.7 mm): (127, 254 mm), 3/8" (9.5 mm): (152.4, 254 mm), 1/4" (6.3 mm): (50.8, 101.6 mm); CrV 50BV30: 3/8" (9.5 mm) (F) x 1/2" (12.7 mm) (M); CrV 50BV30: 1/2" (12.7 mm), 3/8" (9.5 mm), 1/4" (6.3 mm); CrV 50BV30: 1/2" (12.7 mm): 16, 21 mm; CrV 50BV30: 3/8" (9.5 mm): (198 mm), 1/4" (6.3 mm): (152.4 mm); CrV 50BV30: 1/2" (12.7 mm): (255 mm), 3/8" (9.5 mm): (200 mm), 1/4" (6.3 mm): (155 mm); 72T; CrV 6140: 1/4" (6.3 mm): (150 mm); CrV 50BV30: 1/2" (12.7 mm): (250 mm); CrV 50BV30: 3/8" (9.5 mm) x 1/4" (6.3 mm); CrV 6140: 1/2" (12.7 mm) x 3/8" (9.5 mm), 3/8" (9.5 mm) x 1/4" (6.3 mm); CrV 50BV30: 1/4" (6.3 mm) x 1/4" (6.3 mm); CrV 6140: 3/8" (9.5 mm): 5.5, 6.5 mm (L=70 mm); AISI S2: 3/8" (9.5 mm): PH1, PH2, PH3 (L=70 mm); AISI S2: 3/8" (9.5 mm): T20, T30, T40, T45, T50, T55 (L=70 mm); AISI S2: 3/8" (9.5 mm): 6, 7, 8, 10, 12 mm (L=70 mm); AISI S2: 1/4" (6.3 mm): PZ1, PZ2 (L=25 mm); AISI S2: 1/4" (6.3 mm): T8, T10 (L=25 mm); AISI S2: 1/4" (6.3 mm): 4.0, 5.5, 6.5 mm (L=37 mm); AISI S2 / CrV 6150: 1/4" (6.3 mm): PH1, PH2 (L=37 mm); AISI S2 / CrV 6150: 1/4" (6.3 mm): T8, T10, T15, T20, T25, T30, T40 (L=37 mm); AISI S2 / CrV 6150: 1/4" (6.3 mm): 3, 4, 5, 6 mm (L=37 mm); AISI S2 / CrV 6150: 8, 10, 12, 13, 14, 15, 16, 17, 18, 19 mm; CrV: 1.5, 2, 2.5 mm; CrV 6150

| YATO    | 1/2"           | 3/8"          | 1/4"          |   |
|---------|----------------|---------------|---------------|---|
| YT-3887 | 1/2" (12.7 mm) | 3/8" (9.5 mm) | 1/4" (6.3 mm) | 2 |



129  
PCS

CrV 55

SVC55

1/2" (12.7 mm): 12, 13, 14, 15, 16, 17, 18, 19, 20, 21, 22, 24 mm (L=38 mm); 27, 30, 32 mm (L=42 mm), 3/8" (9.5 mm): 10, 11, 12, 13, 14, 15, 16 mm (L=28 mm); 17, 18, 19 mm (L=30 mm), 1/4" (6.3 mm): 4, 4.5, 5, 5.5, 6, 7, 8, 9, 10, 11, 12, 13, 14 mm (L=25 mm); CrV 50BV30: 1/2" (12.7 mm): 10, 12, 13, 14, 17, 19 mm (L=76 mm), 1/4" (6.3 mm): 4, 5, 6, 7, 8, 9 mm (L=50 mm); CrV 50BV30: 1/2" (12.7 mm): 17, 19, 21, 23 mm; CrV 50BV30: 3/8" (9.5 mm): E8, E10, E11, E12, E14, E16, E18, E20; CrV 50BV30: 1/2" (12.7 mm): (127, 254 mm), 3/8" (9.5 mm): (76, 152.4 mm), 1/4" (6.3 mm): (50.8 mm); CrV 50BV30: 1/2" (12.7 mm), 3/8" (9.5 mm), 1/4" (6.3 mm); CrV 50BV30: 3/8" (9.5 mm): 16, 21 mm; CrV 50BV30: 1/2" (12.7 mm): (255 mm), 3/8" (9.5 mm): (200 mm), 1/4" (6.3 mm): (155 mm); 72T; CrV 6140: 1/2" (12.7 mm): (150 mm); CrV 50BV30: 3/8" (9.5 mm): 4.0, 5.5, 6.5 mm (L=50 mm); AISI S2 / CrV 6150: 3/8" (9.5 mm): PH1, PH2, PH3 (L=50 mm); AISI S2 / CrV 6150: 3/8" (9.5 mm): PZ1, PZ2, PZ3 (L=50 mm); AISI S2 / CrV 6150: 3/8" (9.5 mm): T20, T30, T40, T45, T50, T55, T60 (L=50 mm); AISI S2 / CrV 6150: 3/8" (9.5 mm): 3, 4, 5, 6, 8, 10 mm (L=50 mm); AISI S2 / CrV 6150: 8, 10, 11, 12, 13, 14, 15, 16, 17, 18, 19, 22 mm; CrV: 3x75, 4x100, 6.5x150, PH1x75, PH2x100, PH3x150 mm; SVC55: 180 mm; CrV 55: 160 mm; CrV 55: 1.5, 2, 2.5, 3, 4, 5, 6, 7, 8, 10 mm; CrV 6150

| YATO    | 1/2"           | 3/8"          | 1/4"          |   |
|---------|----------------|---------------|---------------|---|
| YT-3888 | 1/2" (12.7 mm) | 3/8" (9.5 mm) | 1/4" (6.3 mm) | 2 |

GB Tool set  
 D Sechskant-Steckschlüssel-Satz  
 PL Zestaw narzędziowy

RUS Набор инструмента  
 CZ Sada nástrčných klíčů a ráčny  
 H Dugókulcs készlet racsnis hajtókarral

RO Rotrușa chei tubulare cu antrenor  
 E Juego de herramientas

BMC & COLOR SLEEVE  
 XXL SIZE

|            |          |        |
|------------|----------|--------|
| 1/2"       | 3/8"     | 1/4"   |
| 12.5 mm    | 10 mm    | 6.3 mm |
| CrV 6140   | CrV 6150 |        |
| CrV 50BV30 | S2       |        |
| AS-DRIVE   | 72T      |        |



2



150 PCS METRIC & S.A.E.

1/2" (12.7 mm): 20, 21, 22, 24 mm (L=38 mm); 27, 30, 32 mm (L=42 mm); 3/8" (9.5 mm): 9, 10, 11, 12, 13, 14, 15, 16 mm (L=28 mm); 17, 18, 19 mm (L=30 mm); 1/4" (6.3 mm): 4, 5, 6, 7, 8, 9, 10, 11, 12, 13 mm (L=25 mm); CrV 50BV30: 1/2" (12.7 mm): 10, 12, 13, 14, 17, 19 mm (L=76 mm); 3/8" (9.5 mm): 10, 11, 12, 13, 14, 15 mm (L=63 mm); 1/4" (6.3 mm): 4, 5, 6, 7, 8, 9 mm (L=50 mm); CrV 50BV30: 1/2" (12.7 mm) x 15/16" (23.8 mm); 1/2" (12.7 mm) x 1" (25.4 mm); 1/2" (12.7 mm) x 1-1/16" (27.0 mm); 1/2" (12.7 mm) x 1-1/4" (31.8 mm); 3/8" (9.5 mm) x 3/8" (9.5 mm); 3/8" (9.5 mm) x 7/16" (11.1 mm); 3/8" (9.5 mm) x 1/2" (12.7 mm); 3/8" (9.5 mm) x 9/16" (14.3 mm); 3/8" (9.5 mm) x 5/8" (15.9 mm); 3/8" (9.5 mm) x 11/16" (17.5 mm); 3/8" (9.5 mm) x 3/4" (19.0 mm); 3/8" (9.5 mm) x 13/16" (20.6 mm); 3/8" (9.5 mm) x 7/8" (22.2 mm); 1/4" (6.3 mm) x 5/32" (4.0 mm); 1/4" (6.3 mm) x 3/16" (4.8 mm); 1/4" (6.3 mm) x 7/32" (5.6 mm); 1/4" (6.3 mm) x 1/4" (6.3 mm); 1/4" (6.3 mm) x 9/32" (7.1 mm); 1/4" (6.3 mm) x 5/16" (7.9 mm); 1/4" (6.3 mm) x 11/32" (8.7 mm); 1/4" (6.3 mm) x 3/8" (9.5 mm); 1/4" (6.3 mm) x 7/16" (11.1 mm); 1/4" (6.3 mm) x 1/2" (12.7 mm); CrV 50BV30: 1/2" (12.7 mm): 17, 19, 21, 23 mm; CrV 50BV30: 3/8" (9.5 mm): E8, E10, E11, E12, E14, E16, E18, E20; CrV 50BV30: 1/2" (12.7 mm): (127, 254 mm); 3/8" (9.5 mm): (76, 152.4 mm); 1/4" (6.3 mm): (50.8 mm); CrV 50BV30: 1/2" (12.7 mm); 3/8" (9.5 mm); 1/4" (6.3 mm); CrV 50BV30: 3/8" (9.5 mm): 16, 21 mm; CrV 50BV30: 1/2" (12.7 mm): (255 mm); 3/8" (9.5 mm): (200 mm); 1/4" (6.3 mm): (155 mm); 72T: CrV 6140: 1/4" (6.3 mm): (150 mm); CrV 50BV30: 1/4" (6.3 mm) x 1/4" (6.3 mm); CrV 6140: 1/4" (6.3 mm): T10, T15, T20, T25, T27, T30, T40 (L=25 mm); AISI S2: 3/8" (9.5 mm): 4, 5.5, 6.5 mm (L=50 mm); AISI S2 / CrV 6150: 3/8" (9.5 mm): PH1, PH2, PH3 (L=50 mm); AISI S2 / CrV 6150: 3/8" (9.5 mm): PZ1, PZ2, PZ3 (L=50 mm); AISI S2 / CrV 6150: 3/8" (9.5 mm): T20, T30, T40, T45, T50, T55, T60 (L=50 mm); AISI S2 / CrV 6150: 3/8" (9.5 mm): 3, 4, 5, 6, 8, 10 mm (L=50 mm); AISI S2 / CrV 6150: 8, 9, 10, 11, 12, 13, 14, 15, 16, 17, 18, 19 mm; CrV: 8x10, 12x13, 17x19 mm; 1.5, 2, 2.5, 3, 4.

| YATO    | 1/2" (12.7 mm) | 3/8" (9.5 mm) | 1/4" (6.3 mm) |   |
|---------|----------------|---------------|---------------|---|
| YT-3881 |                |               |               | 2 |



173 PCS

1/2" (12.7 mm): 10, 11, 12, 13, 14, 15, 16, 17, 18, 19, 20, 21, 22, 23, 24 mm (L=38 mm); 27, 30, 32 mm (L=42 mm); 3/8" (9.5 mm): 10, 11, 12, 13, 14, 15, 16 mm (L=28 mm); 17, 18, 19 mm (L=30 mm); 1/4" (6.3 mm): 4, 4.5, 5, 5.5, 6, 7, 8, 9, 10, 11, 12, 13, 14 mm (L=25 mm); CrV 50BV30: 1/2" (12.7 mm): 16, 17, 18, 19, 22 mm (L=76 mm); 3/8" (9.5 mm): 10, 11, 12, 13, 14, 15 mm (L=63 mm); 1/4" (6.3 mm): 4, 5, 6, 7, 8, 9, 10 mm (L=50 mm); CrV 50BV30: 1/2" (12.7 mm): E18, E20, E24, 3/8" (9.5 mm): E10, E11, E12, E14, E16, 1/4" (6.3 mm): E4, E5, E6, E7, E8; CrV 50BV30: 1/2" (12.7 mm): (127, 254 mm); 3/8" (9.5 mm): (152.4 mm); 1/4" (6.3 mm): (50.8, 101.6 mm); CrV 50BV30: 3/8" (9.5 mm) (F) x 1/2" (12.7 mm) (M); CrV 50BV30: 1/2" (12.7 mm); 3/8" (9.5 mm); 1/4" (6.3 mm); CrV 50BV30: 1/2" (12.7 mm): 16, 21 mm; 3/8" (9.5 mm): 18 mm; CrV 50BV30: 1/4" (6.3 mm); 1/4" (6.3 mm); (152.4 mm); CrV 50BV30: 1/2" (12.7 mm): (255 mm); 3/8" (9.5 mm): (200 mm); 1/4" (6.3 mm): (155 mm); 72T: CrV 6140: 1/4" (6.3 mm): (150 mm); CrV 50BV30: 1/4" (6.3 mm) x 1/4" (6.3 mm); CrV 6140: 1/4" (6.3 mm): 5/16" (7.9 mm): (7.9 mm); PZ3, PZ4 (L=30 mm); AISI S2: 5/16" (7.9 mm): T40, T45, T50, T55, T60, T70 (L=30 mm); AISI S2: 5/16" (7.9 mm): T40, T45, T50, T55, T60, T70 (L=30 mm); AISI S2: 5/16" (7.9 mm): 7, 8, 10, 12, 14 mm (L=30 mm); AISI S2: 1/4" (6.3 mm): T5, T6, T7 (L=25 mm); AISI S2: 1/4" (6.3 mm): T7, T10, T15, T20, T25, T27, T30, T40, T45 (L=25 mm); AISI S2: 1/4" (6.3 mm): M5, M6, M8 (L=25 mm); AISI S2: 1/4" (6.3 mm): RM5, RM6, RM7, RM8, RM9 (L=25 mm); AISI S2: 1/4" (6.3 mm): 4, 5, 5.5, 6, 7 mm (L=37 mm); AISI S2 / CrV 6150: 1/4" (6.3 mm): PH0, PH1, PH2 (L=37 mm); AISI S2 / CrV 6150: 1/4" (6.3 mm): PZ0, PZ1, PZ2 (L=37 mm); AISI S2 / CrV 6150: 1/4" (6.3 mm): T8, T9, T10, T15, T20, T25, T27, T30 (L=37 mm); AISI S2 / CrV 6150: 1/4" (6.3 mm): T8, T9, T10, T15, T20, T25, T27, T30 (L=37 mm); AISI S2 / CrV 6150: 1/4" (6.3 mm): 3, 4, 5, 6 mm (L=37 mm); AISI S2 / CrV 6150: 1.25, 1.5, 2, 2.5, 3, 4, 5 mm; CrV 6150

| YATO    | 1/2" (12.7 mm) | 3/8" (9.5 mm) | 1/4" (6.3 mm) |   |
|---------|----------------|---------------|---------------|---|
| YT-3893 |                |               |               | 2 |

# Socket, accessories & sets Klucze nasadowe, akcesoria i zestawy



GB Tool set  
D Sechskant-Steckschlüssel-Satz  
PL Zestaw narzędziowy

RUS Набор инструмента  
CZ Sada nástrčných klíčů a ráčny  
H Dugókulcs készlet racsnis hajtókarral

RO Rotruşa chei tubulare cu antrenor  
E Juego de herramientas

BMC & COLOR SLEEVE  
XXL SIZE



|          |          |            |
|----------|----------|------------|
| 1/2"     | 3/8"     | 1/4"       |
| 12.5 mm  | 10 mm    | 6.3 mm     |
| CrV 6140 | CrV 6150 | CrV 50BV30 |
| S2       | AS-DRIVE | 72T        |

216 PCS  
MAGNETIC



1/2" (12.7 mm): 10, 11, 12, 13, 14, 15, 17, 19, 20, 21, 22, 24 mm (L=38 mm); 27, 30, 32 mm (L=42 mm); 3/8" (9.5 mm): 10, 11, 12, 13, 14, 15, 16 mm (L=28 mm); 17, 18, 19 mm (L=30 mm); 1/4" (6.3 mm): 4, 5, 6, 7, 8, 9, 10, 11, 12, 13, 14 mm (L=25 mm); CrV 50BV30: 1/2" (12.7 mm): 16, 17, 18, 19, 22 mm (L=76 mm); 3/8" (9.5 mm): 10, 11, 12, 13, 14, 15 mm (L=63 mm); 1/4" (6.3 mm): 4, 5, 6, 7, 8, 9, 10 mm (L=50 mm); CrV 50BV30: 1/2" (12.7 mm): E20, E22, E24, 3/8" (9.5 mm): E10, E11, E12, E14, E16, E18, 1/4" (6.3 mm): E4, E5, E6, E7, E8; CrV 50BV30: 1/2" (12.7 mm): (127, 254 mm); 3/8" (9.5 mm): (125 mm); 1/4" (6.3 mm): (50.8, 101.6 mm); CrV 50BV30: 1/2" (12.7 mm); 3/8" (9.5 mm); 1/4" (6.3 mm); CrV 50BV30: 1/2" (12.7 mm): 16, 21 mm, 3/8" (9.5 mm): 18 mm; CrV 50BV30: 1/2" (12.7 mm): (255 mm); 1/4" (6.3 mm): (152.4 mm); CrV 50BV30: 1/2" (12.7 mm); 1/4" (6.3 mm): (255 mm); 3/8" (9.5 mm): (200 mm); 1/4" (6.3 mm): (155 mm); 72T: CrV 6140: 1/4" (6.3 mm): (150 mm); CrV 50BV30: 1/4" (6.3 mm): (200 mm); CrV 6140: 1/2" (12.7 mm) x 5/16" (7.9 mm); 3/8" (9.5 mm) x 5/16" (7.9 mm); CrV 6140: 1/4" (6.3 mm) x 1/4" (6.3 mm); CrV 6140: 5/16" (7.9 mm): 6, 6.5, 8 mm (L=30 mm); AISI S2: 5/16" (7.9 mm): PH3, PH4 (L=30 mm); AISI S2: 5/16" (7.9 mm): PZ3, PZ4 (L=30 mm); AISI S2: 5/16" (7.9 mm): T25, T27, T30, T35, 2xT40, T45, T50 (L=30 mm); AISI S2: 5/16" (7.9 mm): T27, T30, T35, T40, T45, T50 (L=30 mm); AISI S2: 5/16" (7.9 mm): 5.5, 6, 6.5, 7, 8 mm (L=30 mm); AISI S2: 5/16" (7.9 mm): M5, M6, M8, M10 (L=30 mm); AISI S2: 1/4" (6.3 mm): 4, 5, 5.5, 6 mm (L=25 mm); AISI S2: 1/4" (6.3 mm): PH1, PH2 (L=25 mm); AISI S2: 1/4" (6.3 mm): PZ1, PZ2 (L=25 mm); AISI S2: 1/4" (6.3 mm): T8, T10, T15, T20, T25 (L=25 mm); AISI S2: 1/4" (6.3 mm): T8, 2xT10, 2xT15, 2xT20, 2xT25, T40 (L=25 mm); AISI S2: 1/4" (6.3 mm): 3, 4, 5, 6 mm (L=25 mm); AISI S2: 1/4" (6.3 mm): 3, 4, 5, 6 mm (L=25 mm); AISI S2: 1/4" (6.3 mm): M5, M6, M8 (L=25 mm); AISI S2: 1/4" (6.3 mm): S1, S2 (L=25 mm); AISI S2: 1/4" (6.3 mm): 1, 2, 3 mm (L=25 mm); AISI S2: 1/4" (6.3 mm): 6, 8, 10 mm (L=25 mm); AISI S2: 1/4" (6.3 mm): 4, 6, 8 mm (L=25 mm); AISI S2: 1/2" (12.7 mm): T55, T60 (L=50 mm); AISI S2 / CrV 6150: 1/4" (6.3 mm): 6, 6.5, 8 mm (L=37 mm); AISI S2 / CrV 6150: 1/4" (6.3 mm): PH3, PH4 (L=37 mm); AISI S2 / CrV 6150: 1/4" (6.3 mm): PZ3, PZ4 (L=37 mm); AISI S2 / CrV 6150: 1/4" (6.3 mm): T25, T27, T30, T35, 2xT40, T45, T50 (L=37 mm); AISI S2 / CrV 6150: 1/4" (6.3 mm): T27, T30, T35, T40, T45, T50 (L=37 mm); AISI S2 / CrV 6150: 1/4" (6.3 mm): 5.5, 6, 6.5, 7, 8 mm (L=37 mm); AISI S2 / CrV 6150: 1/4" (6.3 mm): M5, M6, M8, M10 (L=37 mm); AISI S2 / CrV 6150: 1/2" (12.7 mm): 8, 10, 11, 12, 13, 14, 15, 16, 17, 18, 19, 22 mm; CrV: 1.27, 1.5, 2, 2.5, 3, 4, 5 mm; CrV 6150

| YATO    | 1/2" (12.7 mm) | 3/8" (9.5 mm) | 1/4" (6.3 mm) | 2 |
|---------|----------------|---------------|---------------|---|
| YT-3884 |                |               |               |   |



225 PCS  
METRIC & S.A.E.  
CrV 55  
MAGNETIC

1/2" (12.7 mm): 10, 13, 15, 16, 17, 18, 19, 20, 21, 22, 23, 24 mm (L=38 mm); 27, 30, 32 mm (L=42 mm); 3/8" (9.5 mm): 10, 11, 12, 13, 14, 15, 16 mm (L=28 mm); 17, 18, 19 mm (L=30 mm); 1/4" (6.3 mm): 3.5, 4, 4.5, 5, 5.5, 6, 7, 8, 9, 10, 11, 12, 13, 14 mm (L=25 mm); CrV 50BV30: 1/2" (12.7 mm): 10, 11, 12, 13, 14, 15, 17, 19, 21 mm (L=76 mm); 3/8" (9.5 mm): 6, 7, 8, 9, 10 mm (L=63 mm); CrV 50BV30: 1/2" (12.7 mm) x 7/16" (11.1 mm); 1/2" (12.7 mm) x 1/2" (12.7 mm); 1/2" (12.7 mm) x 9/16" (14.3 mm); 1/2" (12.7 mm) x 5/8" (15.9 mm); 1/2" (12.7 mm) x 11/16" (17.5 mm); 1/2" (12.7 mm) x 3/4" (19.0 mm); 1/2" (12.7 mm) x 13/16" (20.6 mm); 1/2" (12.7 mm) x 7/8" (22.2 mm); 1/4" (6.3 mm) x 1/4" (6.3 mm); 1/4" (6.3 mm) x 9/32" (7.1 mm); 1/4" (6.3 mm) x 5/16" (7.9 mm); 1/4" (6.3 mm) x 11/32" (8.7 mm); 1/4" (6.3 mm) x 3/8" (9.5 mm); CrV 50BV30: 1/2" (12.7 mm): 17, 19, 21 mm; CrV 50BV30: 1/2" (12.7 mm): E16, E18, E20, E22, E24, 3/8" (9.5 mm): E10, E11, E12, E14, 1/4" (6.3 mm): E4, E5, E6, E7, E8; CrV 50BV30: 1/2" (12.7 mm): (127, 254 mm); 3/8" (9.5 mm): (76, 254 mm); 1/4" (6.3 mm): (50.8, 101.6 mm); CrV 50BV30: 1/2" (12.7 mm): (127, 254 mm); 3/8" (9.5 mm) (F) x 1/2" (12.7 mm) (M); 1/2" (12.7 mm) (F) x 3/8" (9.5 mm) (M); CrV 50BV30: 1/2" (12.7 mm): 18 mm; CrV 50BV30: 1/4" (6.3 mm): (152.4 mm); CrV 50BV30: 1/2" (12.7 mm): (255 mm); 3/8" (9.5 mm): (200 mm); 1/4" (6.3 mm): (155 mm); 72T: CrV 6140: 1/4" (6.3 mm): (150 mm); CrV 50BV30: 1/4" (6.3 mm): (200 mm); CrV 6140: 1/2" (12.7 mm) x 5/16" (7.9 mm); 3/8" (9.5 mm) x 5/16" (7.9 mm); CrV 6140: 1/4" (6.3 mm) x 1/4" (6.3 mm); CrV 6140: 5/16" (7.9 mm): 6, 6.5, 8 mm (L=30 mm); AISI S2: 5/16" (7.9 mm): 8, 10 mm (L=30 mm); AISI S2: 5/16" (7.9 mm): PH3, PH4 (L=30 mm); AISI S2: 5/16" (7.9 mm): PZ3, PZ4 (L=30 mm); AISI S2: 5/16" (7.9 mm): T25, T27, T30, T35, 2xT40, T45, T50 (L=30 mm); AISI S2: 5/16" (7.9 mm): T27, T30, T35, T40, T45, T50 (L=30 mm); AISI S2: 5/16" (7.9 mm): 5.5, 6, 6.5, 7, 8 mm (L=30 mm); AISI S2: 5/16" (7.9 mm): M5, M6, M8, M10 (L=30 mm); AISI S2: 1/4" (6.3 mm): 4, 5, 5.5, 6 mm (L=25 mm); AISI S2: 1/4" (6.3 mm): PH1, PH2 (L=25 mm); AISI S2: 1/4" (6.3 mm): PZ1, PZ2 (L=25 mm); AISI S2: 1/4" (6.3 mm): T8, T9, T10, T15, T20, T25, T27, T30 (L=25 mm); AISI S2: 1/4" (6.3 mm): T8, T9, T10, T15, T20, T25, T27, T30 (L=25 mm); AISI S2: 1/4" (6.3 mm): 3, 4, 5, 6, 7, 8 mm (L=25 mm); AISI S2: 1/4" (6.3 mm): 3, 4, 5, 6, 7, 8 mm (L=25 mm); AISI S2: 1/4" (6.3 mm): 1, 2, 3, 4 mm (L=25 mm); AISI S2: 1/4" (6.3 mm): 6, 8, 10 mm (L=25 mm); AISI S2: 1/4" (6.3 mm): 4, 6, 8, 10 mm (L=25 mm); AISI S2: 1/2" (12.7 mm): 8, 9, 10, 11, 12, 13, 14, 15, 16, 17, 19, 22 mm; CrV: 6.5x38 mm, PH2x38 mm; SVMCM55: 180 mm; CrV 55: 250 mm; CrV: 2, 2.5, 3, 4, 5, 6, 7, 8, 10, 12 mm; CrV 6150

| YATO    | 1/2" (12.7 mm) | 3/8" (9.5 mm) | 1/4" (6.3 mm) | 2 |
|---------|----------------|---------------|---------------|---|
| YT-3894 |                |               |               |   |

GB Tool set  
D Werkzeug-Satz  
PL Zestaw narzędziowy

RUS Набор инструмента  
CZ Sada nástrčných klíčů a ráčny  
H Dugókulcs készlet racsnis hajtókarral

RO Trusa de scule  
E Juego de herramientas

TEXTILE WALLET



2



250V, 4x190 mm; 5x100 mm, PH1x100 mm; S2;  
9 mm; SK2; 160 mm; CrV; 3 m x 16 mm

**6**  
PCS

\* - product not for european market  
\* - produkt nieprzeznaczony na rynek europejski

|   |   |
|---|---|
| <b>YATO</b>  |  |
| YT-39005*   | 20  |



250V, 4x190 mm; 5x100 mm, PH1x100 mm; S2;  
9 mm; SK2; 200 mm; CrV; 200 mm;  
3 m x 16 mm

**7**  
PCS

\* - product not for european market  
\* - produkt nieprzeznaczony na rynek europejski

|   |   |
|---|---|
| <b>YATO</b>  |  |
| YT-39006*   | 20  |



250V, 4x190 mm; 5x100 mm, PH1x100 mm; S2;  
9 mm; SK2; 180 mm; CrV; 160 mm; CrV;  
200 mm; 3 m x 16 mm; 225 g;

**10**  
PCS

\* - product not for european market  
\* - produkt nieprzeznaczony na rynek europejski

|   |   |
|---|---|
| <b>YATO</b>  |  |
| YT-39002*   | 10  |



250V, 4x190 mm; 5x100 mm, PH1x100 mm; S2;  
9 mm; SK2; 180 mm; CrV; 160 mm; CrV;  
200 mm; 3 m x 16 mm; 225 g;  
PVC 0.13 mm 19 mm x 20 m; 190 mm

**12**  
PCS

\* - product not for european market  
\* - produkt nieprzeznaczony na rynek europejski

|   |   |
|---|---|
| <b>YATO</b>  |  |
| YT-39003*   | 10  |



140 mm; 3x75 mm, PH0x75 mm; S2; 2x50 mm,  
PH00x50 mm; S2; 12-220V; 115 mm; 115 mm;  
140 mm; 30W; 205 mm;  
19.5x190 mm;

**13**  
PCS

\* - product not for european market  
\* - produkt nieprzeznaczony na rynek europejski

|   |   |
|---|---|
| <b>YATO</b>  |  |
| YT-39007*   | 10  |



140 mm; 140 mm; 185 mm;  
12-220V; 130 mm; 115 mm;  
115 mm; 205 mm; 3CR13; 3x75 mm,  
5x100 mm, PH0x75 mm, PH1x100 mm; S2; 2x50 mm, PH00x50 mm; S2;  
30W; 3 m x 16 mm; 150 mm;  
PVC 0.13 mm 19 mm x 20 m; 19.5x190 mm;  
9 mm, SK2

**22**  
PCS

\* - product not for european market  
\* - produkt nieprzeznaczony na rynek europejski

|   |   |
|---|---|
| <b>YATO</b>  |  |
| YT-39008*   | 10  |

GB Tool set  
D Werkzeug-Satz  
PL Zestaw narzędziowy  
RUS Набор инструмента

CZ Sada nástrčných kľučí a ráčny  
H Dugókulcs készlet racsnis hajtókarral  
RO Trusa de scule  
E Juego de herramientas

TEXTILE WALLET  
& COLOR BOX



2



125-250V; 5.5x100 mm, PH1x100 mm; SVC55;  
9 mm; SK5; 180 mm; CrV; 160 mm; CrV;  
200 mm; CrV; 3 m x 16 mm

125-250V; 5x100 mm, PH1x100 mm; S2;  
9 mm; SK5; 180 mm; CrV; 160 mm; CrV;  
200 mm; 3 m x 16 mm

8  
PCS

\* - product not for european market  
\* - produkt nieprzeznaczony na rynek europejski

8  
PCS

\* - product not for european market  
\* - produkt nieprzeznaczony na rynek europejski

|   |   |
|---|---|
| <b>YATO</b>  |  |
| YT-3904*  | 8   |

|   |   |
|---|---|
| <b>YATO</b>  |  |
| YT-3906*  | 8   |





8  
PCS

10, 11, 12, 13, 14, 15, 17, 19 mm; CrV  
\* - product not for european market  
\* - produkt nieprzeznaczony na rynek europejski

8  
PCS

10, 11, 12, 13, 14, 15, 17, 19 mm; CrV  
\* - product not for european market  
\* - produkt nieprzeznaczony na rynek europejski

|  |   |
|--|---|
| <b>YATO</b>  |  |
| YT-3908*   | 8   |

|   |   |
|---|---|
| <b>YATO</b>  |  |
| YT-3909*  | 8   |

GB Torx socket set  
 D Torx-Steckschlüsselsatz  
 PL Klucze nasadowe Torx

RUS Набор головок  
 CZ Nástrčné klíče  
 H Dugókulcs

RO Trusa tubulare  
 E Llaves de vaso

9 PCS  
 TORX  
 CrV 6150

2



1/4" (6.3 mm): E5, E6, E7, E8, 3/8" (9.5 mm): E10, E12, E14, E16;  
 1/4" (6.3 mm) (M) x 3/8" (9.5 mm) (F)

SLIDING CARD

METAL CASE & COLOR SLEEVE



1/2" (12.7 mm): E10, E11, E12, E14, E16, E18, E20, E22, E24

|             |               |       |
|-------------|---------------|-------|
| <b>YATO</b> | ○             |       |
| YT-0520     | 1/4" (6.3 mm) | 10/40 |

|             |                |    |
|-------------|----------------|----|
| <b>YATO</b> | ○              |    |
| YT-0521     | 1/2" (12.7 mm) | 20 |

GB Go-through socket set  
 D Durchgangs-Knarrenkasten  
 PL Zestaw nasadek przelotowych z grzechotką  
 RUS Набор торцевых головок сквозных с трещоткой  
 CZ Sada průchodných nástrčných klíčů

H Dugókulcs készlet, csavarszár átengedős  
 RO Set chei tubulare cu crichet  
 E Juego de boquillas con orificio pasante, con carraca

BMC & COLOR SLEEVE



21 PCS  
 1/2" 1/4" CrV 6140 CrV 50BV30  
 QUICK RELEASE SZYBKO-ZŁĄCZE  
 12.5 mm 6.3 mm METRIC IMPERIAL



10, 11, 12, 13, 14, 15, 16, 17, 18, 19 mm (L=32 mm);  
 3/8" (9.5 mm), 7/16" (11.1 mm), 1/2" (12.7 mm), 9/16" (14.3 mm),  
 5/8" (15.9 mm), 11/16" (17.5 mm), 3/4" (19.0 mm) (L=32 mm); CrV 50BV30;  
 L=178 mm; CrV 6140; 1/2" (12.7 mm), 1/4" (6.3 mm); CrV 6140;  
 17 mm (L=75 mm); CrV 50BV30

|             |                |                    |
|-------------|----------------|--------------------|
| <b>YATO</b> | ○              |                    |
| YT-3865     | 1/2" (12.7 mm) | 1/4" (6.3 mm) 3/12 |

GB Hexagonal socket  
 D Sechskantenschlüssel  
 PL Nasadka sześciokątna  
 RUS Головка шестигранная  
 CZ Šestihranný nástavec  
 H Hatszögű rátét  
 RO Cheie tubulară hexagonală  
 E Boquilla hexagonal

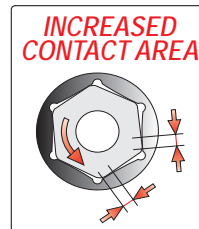
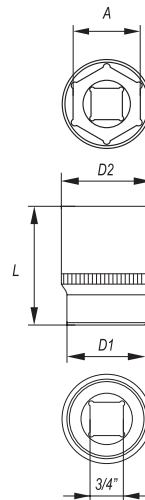

3/4" DIN 3121  
 19 mm CrV 50BV30  
 AS-DRIVE

- application: industry, car service stations and workshops
- for high loads
- drive locks
- surface finish: chromed, satin
- przeznaczenie: przemysł, serwisy i warsztaty
- do największych obciążeń
- zamki blokujące
- wykończenie powierzchni: chromowana, satynowa

COLOR BOX



| YATO    | ○ A (mm) | D1 (mm) | D2 (mm) | L (mm) | PCS packing: |    |
|---------|----------|---------|---------|--------|--------------|----|
| YT-1301 | 19       | 30      | 36      | 50     | 12           | 96 |
| YT-1302 | 21       | 32      | 36      | 50     | 12           | 96 |
| YT-1303 | 22       | 32      | 36      | 50     | 12           | 96 |
| YT-1304 | 23       | 34      | 36      | 50     | 12           | 96 |
| YT-1305 | 24       | 34      | 36      | 50     | 12           | 96 |
| YT-1306 | 25       | 36      | 36      | 50     | 12           | 96 |
| YT-1307 | 26       | 37      | 34      | 50     | 12           | 96 |
| YT-1308 | 27       | 38      | 34      | 50     | 12           | 96 |
| YT-1309 | 28       | 40      | 34      | 50     | 12           | 96 |
| YT-1310 | 29       | 40      | 35      | 50     | 12           | 96 |
| YT-1311 | 30       | 42      | 36      | 55     | 8            | 48 |
| YT-1312 | 32       | 44      | 37      | 55     | 8            | 48 |
| YT-1313 | 33       | 46      | 38      | 55     | 8            | 48 |

| YATO    | ○ A (mm) | D1 (mm) | D2 (mm) | L (mm) | PCS packing: |    |
|---------|----------|---------|---------|--------|--------------|----|
| YT-1314 | 34       | 47      | 38      | 55     | 8            | 48 |
| YT-1315 | 35       | 48      | 42      | 60     | 6            | 36 |
| YT-1316 | 36       | 50      | 42      | 60     | 6            | 36 |
| YT-1317 | 38       | 52      | 45      | 60     | 6            | 36 |
| YT-1318 | 41       | 56      | 45      | 65     | 4            | 32 |
| YT-1319 | 42       | 57      | 45      | 65     | 4            | 32 |
| YT-1320 | 43       | 58      | 45      | 65     | 4            | 32 |
| YT-1322 | 46       | 62      | 48      | 70     | 4            | 32 |
| YT-1323 | 48       | 64      | 48      | 70     | 4            | 24 |
| YT-1324 | 50       | 68      | 48      | 70     | 4            | 24 |
| YT-1326 | 52       | 70      | 48      | 70     | 4            | 20 |
| YT-1328 | 55       | 73      | 48      | 75     | 4            | 20 |
| YT-1330 | 60       | 80      | 48      | 80     | 4            | 20 |



GB Extension bar  
D Verlängerung  
PL Przedłużka  
RUS Удлинитель для воротка  
CZ Prodlužovací přípravek  
H Toldalék  
RO Prelungitor  
E Tubo de prolongación

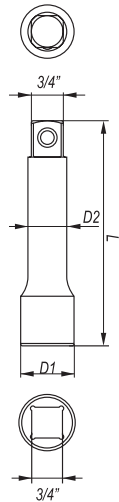

3/4" 19 mm DIN 3121 CrV 50BV30



| YATO    | Ø              | D1 (mm) | D2 (mm) | L (mm) | PCS packing: |    |
|---------|----------------|---------|---------|--------|--------------|----|
| YT-1340 | 3/4" (19.0 mm) | 36      | 22      | 100    | 6            | 36 |
| YT-1341 | 3/4" (19.0 mm) | 36      | 22      | 200    | 5            | 20 |
| YT-1342 | 3/4" (19.0 mm) | 36      | 22      | 400    | 5            | 10 |

GB Adapter  
D Reduktion  
PL Redukcja  
RUS Переходник  
CZ Redukce  
H Redukció  
RO Reducție  
E Reducción

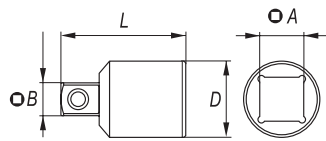

3/4" 19 mm DIN 3121 CrV 50BV30



| YATO    | Ø A                | Ø B                | D (mm) | L (mm) | PCS packing: |    |
|---------|--------------------|--------------------|--------|--------|--------------|----|
| YT-1355 | 3/4" (19.0 mm) (F) | 1/2" (12.7 mm) (M) | 36     | 53     | 12           | 48 |

GB Universal joint  
D Kardangelenk  
PL Przegub Cardana  
RUS Карданный шарнир  
CZ Kardanový kloub  
H Kardán csukló  
RO Articulație Cardanică  
E Articulación Cardan

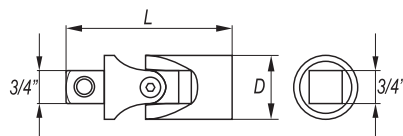

3/4" 19 mm DIN 3121 CrV 50BV30



| YATO    | Ø              | D (mm) | L (mm) | PCS packing: |    |
|---------|----------------|--------|--------|--------------|----|
| YT-1352 | 3/4" (19.0 mm) | 40     | 106    | 12           | 36 |

GB Sliding T-bar  
D Handgriff mit Gleitstück  
PL Pokręto typu „T”  
RUS Вороток Т-образный  
CZ Otočná račka typ „T”  
H „T” alakú hajtókar  
RO Măner clupă tipul „T”  
E Mango tipo „T”

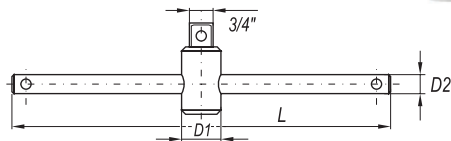

3/4" 19 mm DIN 3121 CrV 50BV30



| YATO    | Ø              | D1 (mm) | D2 (mm) | L (mm) | PCS packing: |    |
|---------|----------------|---------|---------|--------|--------------|----|
| YT-1350 | 3/4" (19.0 mm) | 37      | 20      | 500    | 5            | 10 |

GB Flexible handle  
D Gelenkgriff  
PL Pokręto łamane  
RUS Вороток шарнирный  
CZ Otočná lomená račka  
H Hajlított hajtókar  
RO Prelungitor cu prindere flexibilă  
E Mango articuladо

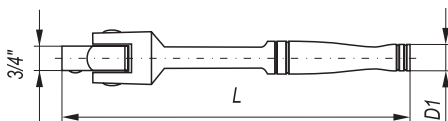

3/4" 19 mm DIN 3121 CrV 50BV30



| YATO    | Ø              | D (mm) | L (mm) | PCS packing: |    |
|---------|----------------|--------|--------|--------------|----|
| YT-1345 | 3/4" (19.0 mm) | 25     | 507    | 5            | 10 |

GB L-type handle  
D Admutternschlüssel  
PL Pokręto typu „L”  
RUS Вороток 1/2” тип „L”  
CZ Páka zahnutá  
H „L” alakú hajtókar  
RO Măner clupă tipul „L”  
E Mango tipo „L”

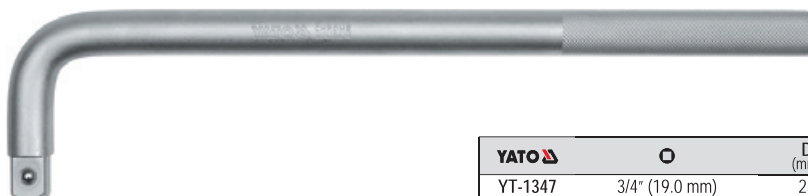

3/4" 19 mm DIN 3121 CrV 50BV30



| YATO    | Ø              | D (mm) | L (mm) | PCS packing: |    |
|---------|----------------|--------|--------|--------------|----|
| YT-1347 | 3/4" (19.0 mm) | 25     | 385    | 5            | 10 |
| YT-1348 | 3/4" (19.0 mm) | 25     | 440    | 5            | 10 |

- GB Quick release ratchet handle
- D Hebelumschaltknarre
- PL Grzechotka
- RUS Трещотка
- CZ Řehtačka
- H Racsnis hajtókar
- RO Dispozitiv de prindere cu clichet
- E Carraca



|       |                             |          |
|-------|-----------------------------|----------|
| 3/4"  | DIN 3122                    | 24T      |
| 19 mm | QUICK RELEASE SZYBKO-ZŁĄCZE | CrV 6140 |



| YATO    | Ø              | T  | L (mm) | ☐  |
|---------|----------------|----|--------|----|
| YT-1360 | 3/4" (19.0 mm) | 24 | 500    | 10 |

- GB Socket set
- D Sechskant-Steckschlüssel-Satz
- PL Komplet nasadek z akcesoriami
- RUS Набор насадок
- CZ Sada nástrčných klíčů a ráčny
- H Dugókulcs készlet racsnis hajtókarral
- RO Rotruşa chei tubulare cu antrenor
- E Juego de boquillas con accesorios



|       |                             |            |
|-------|-----------------------------|------------|
| 3/4"  | CrV 6140                    | CrV 50BV30 |
| 19 mm | QUICK RELEASE SZYBKO-ZŁĄCZE | 24T        |

AS-DRIVE



3/4" (19.0 mm): 30, 32, 34 (L=55 mm); 36, 38 (L=60 mm); 41 (L=65 mm); 46, 50 (L=70 mm); 55 (L=75 mm); 60 mm (L=80 mm); CrV 50BV30; 3/4" (19.0 mm); (L=500 mm); 24T; CrV 6140; 3/4" (19.0 mm); (L=500 mm); CrV 50BV30; 3/4" (19.0 mm); (L=100, 200 mm); CrV 50BV30; 3/4" (19.0 mm); (L=106 mm); CrV 50BV30

15 PCS

| YATO    | Ø              | ☐ |
|---------|----------------|---|
| YT-1334 | 3/4" (19.0 mm) | 1 |



3/4" (19.0 mm): 19, 21, 22, 24 mm (L=50 mm); 26, 27, 28 mm (L=52 mm); 30, 32 mm (L=53 mm); 33, 34 mm (L=56 mm); 36 mm (L=58 mm); 38 mm (L=60 mm); 41 mm (L=64 mm); 46 mm (L=68 mm); 50 mm (L=72mm); CrV 50BV30; 3/4" (19.0 mm) x 620 mm; CrV 6140; 3/4" (19.0 mm); (L=500 mm); CrV 50BV30; 3/4" (19.0 mm) x 100 mm, 3/4" (19.0 mm) x 200 mm; CrV 50BV30

20 PCS

| YATO    | Ø              | ☐ |
|---------|----------------|---|
| YT-1335 | 3/4" (19.0 mm) | 1 |

GB Star bit sockets H Csapkulcs  
D Aufsteckschlüssel RO Chei cu cozi  
PL Klucze trzpieniowe E Llaves  
RUS Набор головок-вставок de mandril  
CZ Čepové klíče

AISI S2  
CrV 6150

SLIDING  
CARD



1/4"

6.3  
mm

AISI  
S2

DIN  
3120

HRC  
58-62

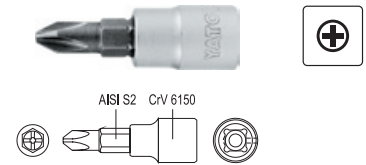
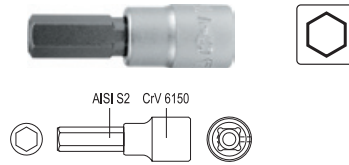
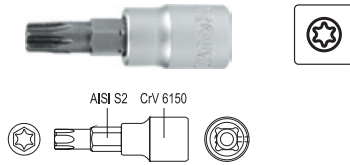

| YATO    | Ø             | ⊕ L (mm) | torque / moment obrotowy max. (Nm) | ⊠      |
|---------|---------------|----------|------------------------------------|--------|
| YT-7660 | 1/4" (6.3 mm) | T8 37    | 3.9                                | 10/100 |
| YT-7661 | 1/4" (6.3 mm) | T10 37   | 5.9                                | 10/100 |
| YT-7662 | 1/4" (6.3 mm) | T15 37   | 9.8                                | 10/100 |
| YT-7663 | 1/4" (6.3 mm) | T20 37   | 18.6                               | 10/100 |
| YT-7664 | 1/4" (6.3 mm) | T25 37   | 26.5                               | 10/100 |
| YT-7665 | 1/4" (6.3 mm) | T30 37   | 42.9                               | 10/100 |
| YT-7666 | 1/4" (6.3 mm) | T40 37   | 75.8                               | 10/100 |

| YATO    | Ø             | ⊖ L (mm) | torque / moment obrotowy max. (Nm) | ⊠      |
|---------|---------------|----------|------------------------------------|--------|
| YT-7667 | 1/4" (6.3 mm) | 3 37     | 14.7                               | 10/100 |
| YT-7668 | 1/4" (6.3 mm) | 4 37     | 26.5                               | 10/100 |
| YT-7669 | 1/4" (6.3 mm) | 5 37     | 53.8                               | 10/100 |
| YT-7670 | 1/4" (6.3 mm) | 6 37     | 88.6                               | 10/100 |
| YT-7671 | 1/4" (6.3 mm) | 7 37     | 120.6                              | 10/100 |
| YT-7672 | 1/4" (6.3 mm) | 8 37     | 170.2                              | 10/100 |

| YATO    | Ø             | ⊕ L (mm) | torque / moment obrotowy max. (Nm) | ⊠      |
|---------|---------------|----------|------------------------------------|--------|
| YT-7673 | 1/4" (6.3 mm) | PH1 37   | 7.6                                | 10/100 |
| YT-7674 | 1/4" (6.3 mm) | PH2 37   | 21.6                               | 10/100 |
| YT-7675 | 1/4" (6.3 mm) | PH3 37   | 44.4                               | 10/100 |

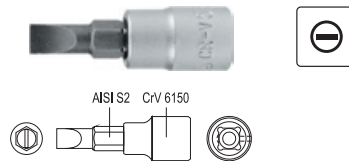
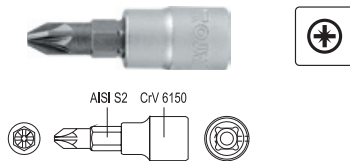

| YATO    | Ø             | ⊕ L (mm) | torque / moment obrotowy max. (Nm) | ⊠      |
|---------|---------------|----------|------------------------------------|--------|
| YT-7676 | 1/4" (6.3 mm) | PZ1 37   | 6.2                                | 10/100 |
| YT-7677 | 1/4" (6.3 mm) | PZ2 37   | 20.1                               | 10/100 |
| YT-7678 | 1/4" (6.3 mm) | PZ3 37   | 44.1                               | 10/100 |

| YATO    | Ø             | ⊖ L (mm) | torque / moment obrotowy max. (Nm) | ⊠      |
|---------|---------------|----------|------------------------------------|--------|
| YT-7679 | 1/4" (6.3 mm) | 4.0 37   | 5.2                                | 10/100 |
| YT-7680 | 1/4" (6.3 mm) | 5.5 37   | 8.8                                | 10/100 |
| YT-7681 | 1/4" (6.3 mm) | 6.5 37   | 16.8                               | 10/100 |

GB Star bit sockets H Csapkulcs  
D Aufsteckschlüssel RO Chei cu cozi  
PL Klucze trzpieniowe E Llaves  
RUS Набор головок-вставок de mandril  
CZ Čepové klíče

AISI S2  
CrV 6150

SLIDING  
CARD



3/8"

10  
mm

AISI  
S2

DIN  
3120

HRC  
58-62

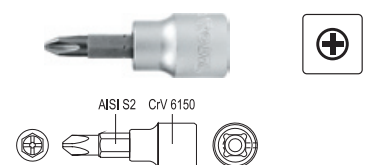
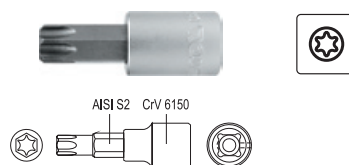
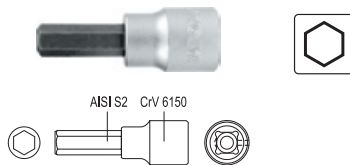

| YATO    | Ø             | ⊖ L (mm) | torque / moment obrotowy max. (Nm) | ⊠      |
|---------|---------------|----------|------------------------------------|--------|
| YT-7693 | 3/8" (9.5 mm) | 3 50     | 14.2                               | 10/100 |
| YT-7694 | 3/8" (9.5 mm) | 4 50     | 27.0                               | 10/100 |
| YT-7695 | 3/8" (9.5 mm) | 5 50     | 53.9                               | 10/100 |
| YT-7696 | 3/8" (9.5 mm) | 6 50     | 89.2                               | 10/100 |
| YT-7697 | 3/8" (9.5 mm) | 7 50     | 122.4                              | 10/100 |
| YT-7698 | 3/8" (9.5 mm) | 8 50     | 174.5                              | 10/100 |
| YT-7699 | 3/8" (9.5 mm) | 10 50    | 220.0                              | 10/100 |

| YATO    | Ø             | ⊕ L (mm) | torque / moment obrotowy max. (Nm) | ⊠      |
|---------|---------------|----------|------------------------------------|--------|
| YT-7682 | 3/8" (9.5 mm) | T10 50   | 6.1                                | 10/100 |
| YT-7683 | 3/8" (9.5 mm) | T15 50   | 11.0                               | 10/100 |
| YT-7684 | 3/8" (9.5 mm) | T20 50   | 18.1                               | 10/100 |
| YT-7685 | 3/8" (9.5 mm) | T25 50   | 27.0                               | 10/100 |
| YT-7686 | 3/8" (9.5 mm) | T27 50   | 34.8                               | 10/100 |
| YT-7687 | 3/8" (9.5 mm) | T30 50   | 41.8                               | 10/100 |
| YT-7688 | 3/8" (9.5 mm) | T40 50   | 77.9                               | 10/100 |
| YT-7689 | 3/8" (9.5 mm) | T45 50   | 120.6                              | 10/100 |
| YT-7690 | 3/8" (9.5 mm) | T50 50   | 175.5                              | 10/100 |
| YT-7691 | 3/8" (9.5 mm) | T55 50   | 205.9                              | 10/100 |
| YT-7692 | 3/8" (9.5 mm) | T60 50   | 379.0                              | 10/100 |

| YATO    | Ø             | ⊕ L (mm) | torque / moment obrotowy max. (Nm) | ⊠      |
|---------|---------------|----------|------------------------------------|--------|
| YT-7700 | 3/8" (9.5 mm) | PH1 50   | 7.4                                | 10/100 |
| YT-7701 | 3/8" (9.5 mm) | PH2 50   | 22.1                               | 10/100 |
| YT-7702 | 3/8" (9.5 mm) | PH3 50   | 45.1                               | 10/100 |

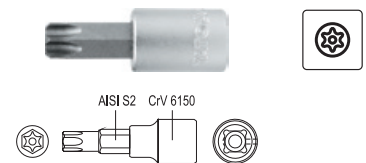
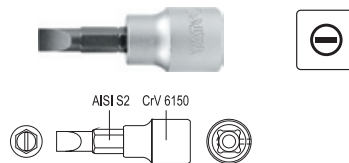
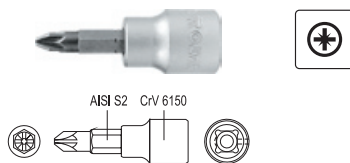

| YATO    | Ø             | ⊕ L (mm) | torque / moment obrotowy max. (Nm) | ⊠      |
|---------|---------------|----------|------------------------------------|--------|
| YT-7703 | 3/8" (9.5 mm) | PZ1 50   | 5.9                                | 10/100 |
| YT-7704 | 3/8" (9.5 mm) | PZ2 50   | 19.2                               | 10/100 |
| YT-7705 | 3/8" (9.5 mm) | PZ3 50   | 43.9                               | 10/100 |

| YATO    | Ø             | ⊖ L (mm) | torque / moment obrotowy max. (Nm) | ⊠      |
|---------|---------------|----------|------------------------------------|--------|
| YT-7706 | 3/8" (9.5 mm) | 5.5 50   | 9.0                                | 10/100 |
| YT-7707 | 3/8" (9.5 mm) | 6.5 50   | 17.2                               | 10/100 |
| YT-7708 | 3/8" (9.5 mm) | 8.0 50   | 20.1                               | 10/100 |

| YATO    | Ø             | ⊕ L (mm) | torque / moment obrotowy max. (Nm) | ⊠      |
|---------|---------------|----------|------------------------------------|--------|
| YT-7709 | 3/8" (9.5 mm) | T45 50   | 122.5                              | 10/100 |
| YT-7710 | 3/8" (9.5 mm) | T50 50   | 176.5                              | 10/100 |
| YT-7711 | 3/8" (9.5 mm) | T55 50   | 218.0                              | 10/100 |
| YT-7712 | 3/8" (9.5 mm) | T60 50   | 379.0                              | 10/100 |

GB Star bit sockets H Csapkulcs  
 D Aufsteckschlüssel RO Chei cu cozi  
 PL Klucze trzpieniowe E Llaves  
 RUS Набор головок-вставок de mandril  
 CZ Čepové klíče



SLIDING CARD



1/2"

12.5 mm

SAISI S2

DIN 3120

HRC 58-62

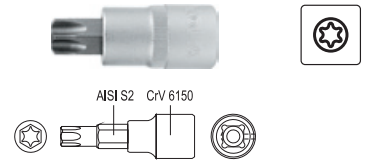
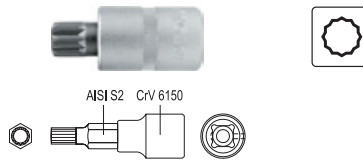
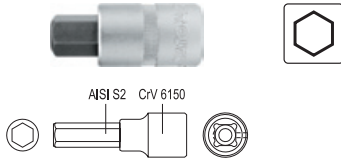

| YATO    | Ø              | ⊘ L (mm) | torque / moment obrotowy max. (Nm) | ⊠      |
|---------|----------------|----------|------------------------------------|--------|
| YT-7723 | 1/2" (12.7 mm) | 4 50     | 26.3                               | 10/100 |
| YT-7724 | 1/2" (12.7 mm) | 5 50     | 52.7                               | 10/100 |
| YT-7725 | 1/2" (12.7 mm) | 6 50     | 89.0                               | 10/100 |
| YT-7726 | 1/2" (12.7 mm) | 7 50     | 128.7                              | 10/100 |
| YT-7727 | 1/2" (12.7 mm) | 8 50     | 174.1                              | 10/100 |
| YT-7728 | 1/2" (12.7 mm) | 10 50    | 220.0                              | 10/100 |
| YT-7729 | 1/2" (12.7 mm) | 12 50    | 370.0                              | 10/100 |
| YT-7730 | 1/2" (12.7 mm) | 14 50    | 590.0                              | 10/100 |
| YT-7731 | 1/2" (12.7 mm) | 17 50    | 1000.0                             | 10/100 |

| YATO    | Ø              | ⊘ L (mm) | torque / moment obrotowy max. (Nm) | ⊠      |
|---------|----------------|----------|------------------------------------|--------|
| YT-7732 | 1/2" (12.7 mm) | M5 50    | 33.9                               | 10/100 |
| YT-7733 | 1/2" (12.7 mm) | M6 50    | 60.8                               | 10/100 |
| YT-7734 | 1/2" (12.7 mm) | M8 50    | 104.2                              | 10/100 |
| YT-7735 | 1/2" (12.7 mm) | M10 50   | 176.5                              | 10/100 |
| YT-7736 | 1/2" (12.7 mm) | M12 50   | 220.0                              | 10/100 |
| YT-7737 | 1/2" (12.7 mm) | M14 50   | 370.0                              | 10/100 |
| YT-7738 | 1/2" (12.7 mm) | M16 50   | 590.0                              | 10/100 |

| YATO    | Ø              | ⊘ L (mm) | torque / moment obrotowy max. (Nm) | ⊠      |
|---------|----------------|----------|------------------------------------|--------|
| YT-7713 | 1/2" (12.7 mm) | T20 50   | 17.9                               | 10/100 |
| YT-7714 | 1/2" (12.7 mm) | T25 50   | 25.5                               | 10/100 |
| YT-7715 | 1/2" (12.7 mm) | T27 50   | 34.1                               | 10/100 |
| YT-7716 | 1/2" (12.7 mm) | T30 50   | 42.6                               | 10/100 |
| YT-7717 | 1/2" (12.7 mm) | T40 50   | 76.7                               | 10/100 |
| YT-7718 | 1/2" (12.7 mm) | T45 50   | 117.0                              | 10/100 |
| YT-7719 | 1/2" (12.7 mm) | T50 50   | 176.5                              | 10/100 |
| YT-7720 | 1/2" (12.7 mm) | T55 50   | 218.0                              | 10/100 |
| YT-7721 | 1/2" (12.7 mm) | T60 50   | 379.0                              | 10/100 |
| YT-7722 | 1/2" (12.7 mm) | T70 50   | 590.0                              | 10/100 |

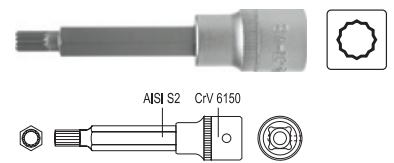
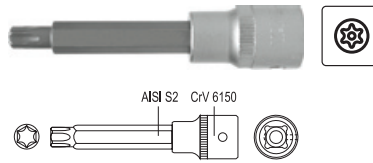
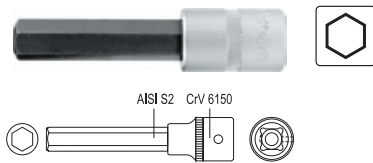

| YATO    | Ø              | ⊘ L (mm) | torque / moment obrotowy max. (Nm) | ⊠      |
|---------|----------------|----------|------------------------------------|--------|
| YT-7739 | 1/2" (12.7 mm) | 4 50     | 27.5                               | 10/100 |
| YT-7740 | 1/2" (12.7 mm) | 5 50     | 53.4                               | 10/100 |
| YT-7741 | 1/2" (12.7 mm) | 6 50     | 89.4                               | 10/100 |
| YT-7742 | 1/2" (12.7 mm) | 7 50     | 132.2                              | 10/100 |
| YT-7743 | 1/2" (12.7 mm) | 8 50     | 176.3                              | 10/100 |
| YT-7744 | 1/2" (12.7 mm) | 10 50    | 220.0                              | 10/100 |
| YT-7745 | 1/2" (12.7 mm) | 12 50    | 370.0                              | 10/100 |
| YT-7746 | 1/2" (12.7 mm) | 14 50    | 590.0                              | 10/100 |
| YT-7747 | 1/2" (12.7 mm) | 17 50    | 1000.0                             | 10/100 |

| YATO    | Ø              | ⊘ L (mm) | torque / moment obrotowy max. (Nm) | ⊠      |
|---------|----------------|----------|------------------------------------|--------|
| YT-0434 | 1/2" (12.7 mm) | T20 100  | 12.7                               | 10/100 |
| YT-0441 | 1/2" (12.7 mm) | T25 100  | 19.0                               | 10/100 |
| YT-0435 | 1/2" (12.7 mm) | T27 100  | 26.9                               | 10/100 |
| YT-0442 | 1/2" (12.7 mm) | T30 100  | 37.4                               | 10/100 |
| YT-0436 | 1/2" (12.7 mm) | T40 100  | 65.1                               | 10/100 |
| YT-0437 | 1/2" (12.7 mm) | T45 100  | 104.0                              | 10/100 |
| YT-0443 | 1/2" (12.7 mm) | T50 100  | 159.0                              | 10/100 |
| YT-0438 | 1/2" (12.7 mm) | T55 100  | 257.0                              | 10/100 |
| YT-0439 | 1/2" (12.7 mm) | T60 100  | 446.0                              | 10/100 |
| YT-0440 | 1/2" (12.7 mm) | T70 100  | 701.0                              | 10/100 |

| YATO    | Ø              | ⊘ L (mm) | torque / moment obrotowy max. (Nm) | ⊠      |
|---------|----------------|----------|------------------------------------|--------|
| YT-0450 | 1/2" (12.7 mm) | M5 100   | 16.0                               | 10/100 |
| YT-0451 | 1/2" (12.7 mm) | M6 100   | 30.0                               | 10/100 |
| YT-0452 | 1/2" (12.7 mm) | M8 100   | 52.0                               | 10/100 |
| YT-0453 | 1/2" (12.7 mm) | M10 100  | 120.0                              | 10/100 |
| YT-0454 | 1/2" (12.7 mm) | M12 100  | 220.0                              | 10/100 |
| YT-0455 | 1/2" (12.7 mm) | M14 100  | 370.0                              | 10/100 |
| YT-0456 | 1/2" (12.7 mm) | M16 100  | 590.0                              | 10/100 |
| YT-0457 | 1/2" (12.7 mm) | M17 100  | 590.0                              | 10/100 |

GB Star bit sockets H Csapkulcs  
 D Aufsteckschlüssel RO Chei cu cozi  
 PL Klucze trzpieniowe E Llaves  
 RUS Набор головок-вставок de mandril



SLIDING CARD



218 Nm max.

DIN 3120

SAISI S2

HRC 58-62

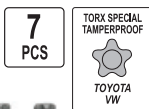

1/4" (6.3 mm): L=35 mm; TS10, TS15, TS20, TS25, TS27, TS30, TS40

1/4" (6.3 mm): L=35 mm; T8, T10, T15, T20, T25, T27, T30  
 3/8" (9.5 mm): L=50 mm; T40, T45, T47, T50, T55

1/4" (6.3 mm): L=35 mm; T8, T10, T15, T20, T25, T27, T30  
 3/8" (9.5 mm): L=50 mm; T40, T45, T47, T50, T55

| YATO    | ⊠     |
|---------|-------|
| YT-0461 | 12/48 |

| YATO    | ⊠    |
|---------|------|
| YT-0430 | 6/48 |

| YATO    | ⊠    |
|---------|------|
| YT-0431 | 6/48 |



1/4" (6.3 mm): L=35 mm; H2, H3, H4, H5, H6  
 3/8" (9.5 mm): L=50 mm; H7, H8, H10, H12

1/4" (6.3 mm): L=35 mm; M5, M6  
 3/8" (9.5 mm): L=50 mm; M8, M10, M12

| YATO    | ⊠    |
|---------|------|
| YT-0432 | 6/36 |

| YATO    | ⊠     |
|---------|-------|
| YT-0433 | 12/48 |

GB Bit socket set  
D Aufsteckschlüssel-Satz  
PL Zestaw kluczy trzpieniowych  
RUS Набор головок-вставок

CZ Čepové klíče  
H Csapkulcs  
RO Chei cu cozi  
E Juego de llaves de mandril

BMC  
& COLOR  
SLEEVE



|             |              |      |
|-------------|--------------|------|
| 18<br>PCS   | 1/2"         | 1/4" |
| 12.5<br>mm  | 6.3<br>mm    |      |
| CrV<br>6150 | HRC<br>58-62 |      |
| AISI<br>S2  | DIN<br>3120  |      |



- 1/4" (6.3 mm): 4, 5.5, 6.5 mm (L=37 mm); AISI S2 / CrV 6150;
- ◆ 1/4" (6.3 mm): PH1, PH2, PH3 (L=37 mm); AISI S2 / CrV 6150;
- 1/2" (12.7 mm): M5, M6, M8, M10, M12, M14 (L=50 mm); M5, M6, M8, M10, M12, M14 (L=100 mm); AISI S2 / CrV 6150

| YATO    | □              | ○             | □  |
|---------|----------------|---------------|----|
| YT-7750 | 1/2" (12.7 mm) | 1/4" (6.3 mm) | 10 |



- ◆ 1/2" (12.7 mm): T30, T40, T45, T50, T55, T60 (L=50 mm); T30, T40, T45, T50, T55, T60 (L=100 mm); AISI S2 / CrV 6150;
- 1/4" (6.3 mm): T10, T15, T20, T25, T30, T40 (L=37 mm); AISI S2 / CrV 6150

| YATO    | □              | ○             | □  |
|---------|----------------|---------------|----|
| YT-7751 | 1/2" (12.7 mm) | 1/4" (6.3 mm) | 10 |



- 1/2" (12.7 mm): 5, 6, 7, 8, 10, 12 mm (L=50 mm); 5, 6, 7, 8, 10, 12 mm (L=100 mm); AISI S2 / CrV 6150;
- 1/4" (6.3 mm): 3, 4, 5, 6, 7, 8 mm (L=37 mm); AISI S2 / CrV 6150

| YATO    | □              | ○             | □  |
|---------|----------------|---------------|----|
| YT-7752 | 1/2" (12.7 mm) | 1/4" (6.3 mm) | 10 |

GB Bit socket set  
D Aufsteckschlüssel-Satz  
PL Zestaw kluczy trzpieniowych  
RUS Набор головок-вставок

CZ Čepové klíče  
H Csapkulcs  
RO Chei cu cozi  
E Juego de llaves de mandril

BMC  
& COLOR  
SLEEVE



|            |              |             |
|------------|--------------|-------------|
| 12<br>PCS  | 1/2"         | CrV<br>6150 |
| 12.5<br>mm | HRC<br>58-62 |             |
| AISI<br>S2 | DIN<br>3120  |             |



- 1/2" (12.7 mm): M12, M17 (L=50 mm); M6 (L=70 mm); M7, M8 (L=100 mm); M8, M10 (L=120 mm); M6, M10, M12 (L=140 mm); M5 (L=180 mm); M6 (L=250 mm); AISI S2 / CrV 6150

| YATO    | ○              | □  |
|---------|----------------|----|
| YT-7753 | 1/2" (12.7 mm) | 10 |

# 3

**Impact sockets,  
accessories & sets**

**Udarowe klucze nasadowe,  
akcesoria i zestawy**



**Impact sockets 3/8"**  
Klucze nasadowe udarowe 3/8"

72



**Impact accessories 3/4"**  
Akcesoria udarowe 3/4"

77



**Impact sockets**

Klucze nasadowe udarowe, krótkie..... 72

**Deep impact sockets**

Klucze nasadowe udarowe, długie..... 72

**Impact accessories 3/8"**

**Akcesoria udarowe 3/8"**

72



**Impact extension bars**

Przedłużki udarowe..... 77

**Impact extension bars with adapter**

Przedłużki udarowe z redukcją..... 77

**Impact adapters**

Redukcje udarowe..... 77

**Impact universal joints**

Przeguby kuliste udarowe..... 77

**Impact extension bars**

Przedłużki udarowe..... 72

**Impact adapters**

Redukcje udarowe..... 72

**Impact universal joints**

Przeguby kuliste udarowe..... 72

**Impact sockets 1"**

**Udarowe klucze nasadowe 1"**

78



**Impact sockets**

Klucze nasadowe udarowe, krótkie..... 78

**Deep impact sockets**

Klucze nasadowe udarowe, długie..... 78

**Impact sockets 1/2"**

**Klucze nasadowe udarowe 1/2"**

73-74



**Impact accessories 1"**

**Akcesoria udarowe 1"**

78



**Impact sockets & sets**

Klucze nasadowe udarowe i zestawy, krótkie..... 73

**Impact sockets, CrV**

Klucze nasadowe udarowe, krótkie, CrV..... 73

**Deep impact sockets & sets**

Klucze nasadowe udarowe i zestawy, długie..... 74

**Deep non-slip impact sockets**

Udarowe nasadki „Non-slip”, długie..... 74

**Impact extension bars with adapter**

Przedłużki udarowe z redukcją..... 78

**Impact accessories 1/2"**

**Akcesoria udarowe 1/2"**

75



**Impact bit socket sets 1/2"**

**Zestawy udarowych kluczy trzpieniowych 1/2"**

79



**Impact extension bars**

Przedłużki udarowe..... 75

**Impact adapters**

Redukcje udarowe..... 75

**Impact universal joints**

Przeguby kuliste udarowe..... 75

**Universal joints**

Przeguby Cardana..... 75

**Spline impact bit sets 3/4"**

**Zestawy bitów udarowych „Spline” 3/4"**

79



**Impact sockets 3/4"**

**Udarowe klucze nasadowe 3/4"**

76-77



**Impact sockets & sets**

Klucze nasadowe udarowe i zestawy, krótkie..... 76

**Deep impact sockets & sets**

Klucze nasadowe udarowe i zestawy, długie..... 76

GB Hexagonal impact socket  
 D Kraftschrauber-Einsatz  
 PL Nasadka uderowa sześciokątna  
 RUS Головка ударная 6-гранная  
 CZ Šestihřanný nástavec  
 H Hatszögű rátét  
 RO Cheie tubulară hexagonală de impact  
 E Boquilla de percusión

3/8" CrMo SCM-440  
 10 mm AS-DRIVE

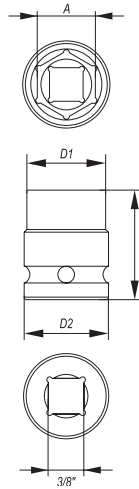

COLOR BOX



\* - product not for european market  
 \* - produkt nieprzeznaczony na rynek europejski

| YATO     | ∅ A (mm) | D1 (mm) | D2 (mm) | L (mm) | PCS packing |     |
|----------|----------|---------|---------|--------|-------------|-----|
| YT-3750* | 6        | 12.0    | 18.0    | 30     | 36          | 432 |
| YT-3751* | 7        | 13.0    | 18.0    | 30     | 36          | 432 |
| YT-3752* | 8        | 14.5    | 18.0    | 30     | 36          | 432 |
| YT-3753* | 9        | 15.0    | 18.0    | 30     | 36          | 432 |
| YT-3754* | 10       | 16.0    | 18.0    | 30     | 36          | 432 |
| YT-3755* | 11       | 17.5    | 18.0    | 30     | 36          | 432 |
| YT-3756* | 12       | 19.0    | 19.0    | 30     | 36          | 432 |
| YT-3757* | 13       | 20.0    | 22.0    | 30     | 32          | 384 |
| YT-3758* | 14       | 21.0    | 22.0    | 30     | 32          | 384 |
| YT-3759* | 15       | 22.0    | 22.0    | 30     | 24          | 288 |
| YT-3760* | 16       | 24.0    | 22.0    | 30     | 24          | 288 |
| YT-3761* | 17       | 25.0    | 22.0    | 30     | 24          | 288 |
| YT-3762* | 18       | 26.0    | 22.0    | 30     | 16          | 192 |
| YT-3763* | 19       | 27.5    | 22.0    | 30     | 16          | 192 |
| YT-3764* | 20       | 28.0    | 22.0    | 30     | 16          | 192 |
| YT-3765* | 21       | 30.0    | 22.0    | 30     | 16          | 192 |
| YT-3766* | 22       | 32.0    | 22.0    | 30     | 16          | 192 |
| YT-3767* | 23       | 33.0    | 22.0    | 30     | 16          | 192 |
| YT-3768* | 24       | 34.0    | 22.0    | 30     | 16          | 192 |

GB Hexagonal deep impact socket  
 D Kraftschrauber-Einsatz, lang  
 PL Nasadka uderowa sześciokątna długa  
 RUS Головка ударная 6-гранная глубокая  
 CZ Šestihřanný hluboký nástavec  
 H Hatszögű rátét mély  
 RO Cheie tubulară hexagonală de impact adâncă  
 E Boquilla de percusión profunda

3/8" CrMo SCM-440  
 10 mm AS-DRIVE

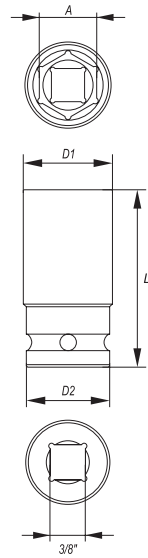

COLOR BOX



\* - product not for european market  
 \* - produkt nieprzeznaczony na rynek europejski

| YATO     | ∅ A (mm) | D1 (mm) | D2 (mm) | L (mm) | PCS packing |     |
|----------|----------|---------|---------|--------|-------------|-----|
| YT-3770* | 6        | 12.0    | 18.0    | 63     | 18          | 216 |
| YT-3771* | 7        | 13.0    | 18.0    | 63     | 18          | 216 |
| YT-3772* | 8        | 14.5    | 18.0    | 63     | 18          | 216 |
| YT-3773* | 9        | 15.8    | 18.0    | 63     | 18          | 216 |
| YT-3774* | 10       | 16.0    | 18.0    | 63     | 18          | 216 |
| YT-3775* | 11       | 17.5    | 18.0    | 63     | 18          | 216 |
| YT-3776* | 12       | 19.0    | 19.0    | 63     | 18          | 216 |
| YT-3777* | 13       | 20.0    | 22.0    | 63     | 16          | 192 |
| YT-3778* | 14       | 21.0    | 22.0    | 63     | 16          | 192 |
| YT-3779* | 15       | 22.0    | 22.0    | 63     | 12          | 144 |
| YT-3780* | 16       | 24.0    | 22.0    | 63     | 12          | 144 |
| YT-3781* | 17       | 25.0    | 22.0    | 63     | 12          | 144 |
| YT-3782* | 18       | 26.0    | 26.0    | 63     | 12          | 144 |
| YT-3783* | 19       | 19.0    | 27.5    | 63     | 6           | 72  |
| YT-3784* | 20       | 20.0    | 28.0    | 63     | 6           | 72  |
| YT-3785* | 21       | 21.0    | 30.0    | 63     | 6           | 72  |
| YT-3786* | 22       | 22.0    | 32.0    | 63     | 5           | 60  |
| YT-3787* | 23       | 23.0    | 33.0    | 63     | 5           | 60  |
| YT-3788* | 24       | 24.0    | 34.0    | 63     | 5           | 60  |

GB Impact extension bar  
 D Verlängerung  
 PL Przedłużka uderowa  
 RUS Удлинитель ударный

CZ Prodlužovací přípravek  
 H Toldalék  
 RO Prelungitor  
 E Tubo de prolongación

3/8" CrMo SCM-440  
 10 mm

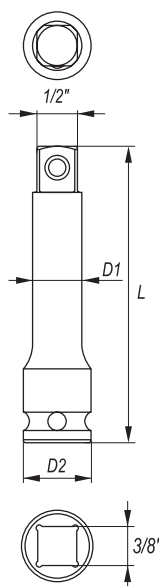

COLOR BOX



\* - product not for european market  
 \* - produkt nieprzeznaczony na rynek europejski

| YATO     | ∅             | D1 (mm) | D2 (mm) | L (mm) | PCS packing |     |
|----------|---------------|---------|---------|--------|-------------|-----|
| YT-3793* | 3/8" (9.5 mm) | 19      | 12.3    | 75     | 22          | 264 |
| YT-3794* | 3/8" (9.5 mm) | 19      | 12.3    | 125    | 12          | 144 |
| YT-3795* | 3/8" (9.5 mm) | 19      | 12.3    | 250    | 20          | 80  |

GB Impact adapter  
 D Reduktion  
 PL Redukcja uderowa  
 RUS Переходник  
 CZ Redukce  
 H Redukció  
 RO Reducție  
 E Reducció

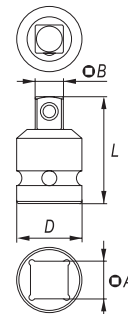

COLOR BOX



\* - product not for european market  
 \* - produkt nieprzeznaczony na rynek europejski

| YATO     | ∅                 | ∅                  | D (mm) | L (mm) | PCS packing |     |
|----------|-------------------|--------------------|--------|--------|-------------|-----|
| YT-3790* | 3/8" (9.5 mm) (F) | 1/4" (6.3 mm) (M)  | 22     | 32     | 32          | 384 |
| YT-3791* | 3/8" (9.5 mm) (F) | 1/2" (12.7 mm) (M) | 24     | 54     | 20          | 240 |

GB Impact universal joint  
 D Gelenstück  
 PL Przegub kulisty uderowy  
 RUS Кардан ударный  
 CZ Kloub kulový  
 H Univerzális csatlakozó  
 RO Adaptor  
 E Articulación redonda

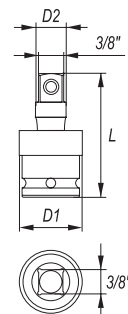

COLOR BOX



\* - product not for european market  
 \* - produkt nieprzeznaczony na rynek europejski

| YATO     | ∅             | D1 (mm) | D2 (mm) | L (mm) | PCS packing |     |
|----------|---------------|---------|---------|--------|-------------|-----|
| YT-3792* | 3/8" (9.5 mm) | 27      | 12.7    | 54     | 12          | 144 |



# Impact sockets, accessories & sets Udarowe klucze nasadowe, akcesoria i zestawy



- GB Hexagonal impact socket
- D Kraftschrauber-Einsatz
- PL Nasadka udarowa sześciokątna
- RUS Головка ударная 6-гранная
- CZ Šestihřanný nástavec
- H Hatszögű rátét
- RO Cheie tubulară hexagonală de impact
- E Boquilla de percusión

COLOR BOX



1/2" CrMo  
SCM-440  
12.5 mm AS-DRIVE

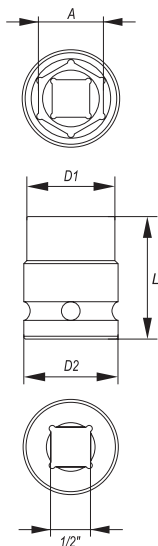

| YATO    | ∅ A (mm) | D1 (mm) | D2 (mm) | L (mm) | PCS packing: |     |
|---------|----------|---------|---------|--------|--------------|-----|
| YT-1000 | 10       | 17.5    | 25.0    | 39     | 60           | 240 |
| YT-1001 | 11       | 18.5    | 25.0    | 39     | 60           | 240 |
| YT-1002 | 12       | 20.0    | 25.0    | 39     | 60           | 240 |
| YT-1003 | 13       | 21.0    | 25.0    | 39     | 60           | 240 |
| YT-1004 | 14       | 22.5    | 25.0    | 39     | 60           | 240 |
| YT-1005 | 15       | 23.5    | 30.0    | 39     | 40           | 160 |
| YT-1006 | 16       | 24.0    | 30.0    | 39     | 40           | 160 |
| YT-1007 | 17       | 26.0    | 30.0    | 39     | 40           | 160 |
| YT-1008 | 18       | 27.5    | 30.0    | 39     | 40           | 160 |
| YT-1009 | 19       | 28.0    | 30.0    | 39     | 40           | 160 |
| YT-1010 | 20       | 30.0    | 30.0    | 39     | 40           | 160 |
| YT-1011 | 21       | 30.0    | 30.0    | 39     | 40           | 160 |
| YT-1012 | 22       | 32.0    | 30.0    | 39     | 30           | 120 |
| YT-1013 | 23       | 32.0    | 30.0    | 39     | 30           | 120 |
| YT-1014 | 24       | 34.0    | 30.0    | 43     | 30           | 120 |
| YT-1015 | 25       | 35.0    | 30.0    | 43     | 30           | 120 |
| YT-1016 | 26       | 38.0    | 30.0    | 43     | 24           | 96  |
| YT-1017 | 27       | 38.0    | 30.0    | 43     | 24           | 96  |
| YT-1018 | 28       | 40.0    | 30.0    | 48     | 24           | 96  |
| YT-1019 | 29       | 41.0    | 30.0    | 48     | 22           | 88  |
| YT-1020 | 30       | 42.0    | 30.0    | 48     | 24           | 96  |
| YT-1022 | 32       | 44.0    | 30.0    | 48     | 20           | 80  |

- GB Impact socket set
- D Kraftschrauber-Einsätze
- PL Zestaw nasadek udarowych
- RUS Набор торцевых ударных головок
- CZ Sada nástrčných kľučů pro úderové utahováky

- H Dugófej készlet ütvebehajtóhoz
- RO Set chei tubulare pt. impact
- E Juego de boquillas de percusión cortas



METAL CASE & COLOR BOX

10 PCS 1/2" CrMo  
SCM-440  
12.5 mm AS-DRIVE



1/2" (12.7 mm): 10, 12, 13, 14, 15, 16, 17, 18, 19, 22 mm; L=39 mm

| YATO    | ∅              |    |
|---------|----------------|----|
| YT-1025 | 1/2" (12.7 mm) | 20 |

- GB Hexagonal impact socket
- D Kraftschrauber-Einsatz
- PL Nasadka udarowa sześciokątna
- RUS Головка ударная 6-гранная
- CZ Šestihřanný nástavec
- H Hatszögű rátét
- RO Cheie tubulară hexagonală de impact
- E Boquilla de percusión

COLOR BOX



1/2" CrV  
12.5 mm AS-DRIVE

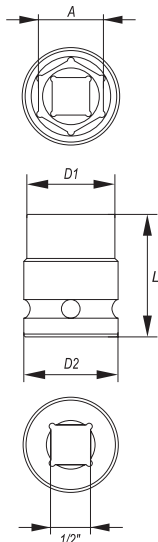

- \* - product not for european market
- \* - produkt nieprzeznaczony na rynek europejski

| YATO     | ∅ A (mm) | D1 (mm) | D2 (mm) | L (mm) | PCS packing: |     |
|----------|----------|---------|---------|--------|--------------|-----|
| YT-1780* | 8        | 15.0    | 24.0    | 38     | 12           | 240 |
| YT-1781  | 9        | 15.5    | 24.0    | 38     | 12           | 240 |
| YT-1782  | 10       | 17.0    | 24.0    | 38     | 12           | 240 |
| YT-1783* | 11       | 18.0    | 24.0    | 38     | 12           | 240 |
| YT-1784  | 12       | 19.0    | 24.0    | 38     | 12           | 240 |
| YT-1785  | 13       | 20.0    | 23.5    | 38     | 12           | 240 |
| YT-1786* | 14       | 22.0    | 24.0    | 38     | 12           | 240 |
| YT-1787  | 15       | 24.0    | 24.0    | 38     | 12           | 240 |
| YT-1788* | 16       | 24.0    | 24.0    | 38     | 12           | 240 |
| YT-1789  | 17       | 26.0    | 26.0    | 38     | 12           | 240 |
| YT-1790* | 18       | 28.0    | 28.0    | 38     | 12           | 144 |
| YT-1791  | 19       | 27.5    | 27.5    | 38     | 12           | 144 |
| YT-1792  | 20       | 30.0    | 30.0    | 38     | 12           | 144 |
| YT-1793  | 21       | 30.0    | 30.0    | 38     | 12           | 144 |
| YT-1794  | 22       | 32.0    | 32.0    | 38     | 12           | 96  |
| YT-1795  | 23       | 34.0    | 34.0    | 40     | 12           | 96  |
| YT-1796* | 24       | 34.0    | 34.0    | 40     | 12           | 96  |
| YT-1797  | 27       | 37.5    | 37.5    | 41     | 10           | 80  |
| YT-1798  | 30       | 42.0    | 42.0    | 42     | 10           | 80  |
| YT-1799  | 32       | 44.0    | 44.0    | 44     | 10           | 80  |

- GB Hexagonal deep impact socket
- D Kraftschrauber-Einsatz, lang
- PL Nasadka uderowa sześciokątna długa
- RUS Головка ударная 6-гранная глубокая
- CZ Šestihřanný hluboký nástavec
- H Hatszögű rátét mély
- RO Cheie tubulară hexagonală de impact adâncă
- E Boquilla de percusión profunda

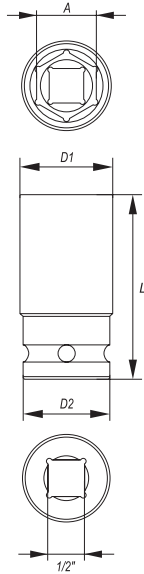

COLOR BOX



1/2" 12.5 mm CrMo SCM-440 AS-DRIVE

| YATO    | ∅ A (mm) | D1 (mm) | D2 (mm) | L (mm) | PCS packing |     |
|---------|----------|---------|---------|--------|-------------|-----|
| YT-1030 | 10       | 17.5    | 24.0    | 78     | 30          | 120 |
| YT-1031 | 11       | 18.5    | 24.0    | 78     | 30          | 120 |
| YT-1032 | 12       | 20.0    | 24.0    | 78     | 30          | 120 |
| YT-1033 | 13       | 21.0    | 24.0    | 78     | 30          | 120 |
| YT-1034 | 14       | 22.0    | 24.0    | 78     | 30          | 120 |
| YT-1035 | 15       | 23.7    | 24.0    | 78     | 30          | 120 |
| YT-1036 | 16       | 24.0    | 24.0    | 78     | 30          | 120 |
| YT-1037 | 17       | 26.0    | 26.0    | 78     | 25          | 100 |
| YT-1038 | 18       | 28.0    | 28.0    | 78     | 24          | 96  |
| YT-1039 | 19       | 28.0    | 28.0    | 78     | 24          | 96  |
| YT-1040 | 20       | 30.0    | 30.0    | 78     | 20          | 80  |
| YT-1041 | 21       | 30.0    | 30.0    | 78     | 20          | 80  |
| YT-1042 | 22       | 32.0    | 30.0    | 78     | 18          | 72  |
| YT-1043 | 23       | 32.0    | 30.0    | 78     | 15          | 60  |
| YT-1044 | 24       | 34.0    | 30.0    | 78     | 15          | 60  |
| YT-1045 | 25       | 35.0    | 30.0    | 78     | 15          | 60  |
| YT-1046 | 26       | 38.0    | 30.0    | 78     | 12          | 48  |
| YT-1047 | 27       | 38.0    | 30.0    | 78     | 12          | 48  |
| YT-1048 | 28       | 40.0    | 30.0    | 78     | 12          | 48  |
| YT-1049 | 29       | 41.0    | 30.0    | 78     | 10          | 40  |
| YT-1050 | 30       | 42.0    | 30.0    | 78     | 10          | 40  |
| YT-1052 | 32       | 44.0    | 30.0    | 78     | 10          | 40  |

- GB Impact socket set
- D Kraftschrauber-Einsätze
- PL Zestaw nasadek uderowych
- RUS Набор торцевых ударных головок
- CZ Sada nástrčných klíčů pro úderové utahovky
- H Dugófej készlet üvebehajtóhoz
- RO Set chei tubulare pt. impact
- E Juego de boquillas de percusión cortas

METAL CASE & COLOR BOX



1/2" CrMo SCM-440 12.5 mm AS-DRIVE



11 PCS

1/2" (12.7 mm): 10, 12, 13, 14, 15, 16, 17, 18, 19, 22, 24 mm; L=78 mm

15 PCS

1/2" (12.7 mm): 10, 12, 13, 14, 15, 16, 17, 18, 19, 21, 22, 24, 27, 30, 32 mm; L=78 mm

| YATO    | ∅              |    |
|---------|----------------|----|
| YT-1054 | 1/2" (12.7 mm) | 10 |

| YATO    | ∅              |   |
|---------|----------------|---|
| YT-1055 | 1/2" (12.7 mm) | 4 |

- GB Hexagonal deep impact socket NON-SLIP
- D Kraftschrauber-Einsatz, lang NON-SLIP
- PL Nasadka uderowa sześciokątna długa NON-SLIP
- RUS Головка ударная 6-гранная глубокая NON-SLIP
- CZ Šestihřanný hluboký nástavec NON-SLIP
- H Hatszögű rátét mély NON-SLIP
- RO Cheie tubulară hexagonală de impact adâncă NON-SLIP
- E Boquilla de percusión profunda NON-SLIP

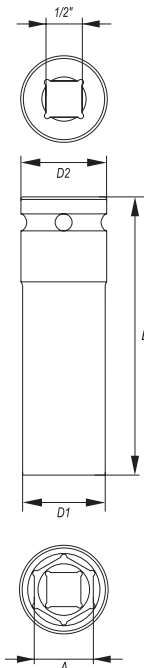

PLASTIC HANGER

10 PCS

COLOR BOX



1/2" 12.5 mm CrMo SCM-440

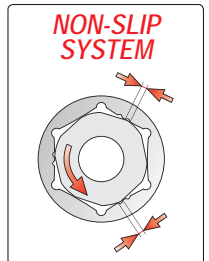

| YATO     | ∅ A (mm) | D1 (mm) | D2 (mm) | L (mm) | PCS packing |     |
|----------|----------|---------|---------|--------|-------------|-----|
| YT-1588  | 10       | 12.40   | 19.55   | 80     | 10          | 160 |
| YT-1589  | 11       | 18.90   | 19.60   | 80     | 10          | 160 |
| YT-1590  | 12       | 19.90   | 24.62   | 80     | 10          | 160 |
| YT-1591  | 13       | 20.95   | 24.70   | 80     | 10          | 160 |
| YT-1592  | 14       | 22.88   | 24.74   | 80     | 10          | 160 |
| YT-1593  | 15       | 23.85   | 24.63   | 80     | 10          | 120 |
| YT-1594  | 16       | 24.64   | 24.64   | 80     | 10          | 120 |
| YT-1595* | 17       | 26.40   | 29.70   | 80     | 10          | 120 |
| YT-1596  | 18       | 27.90   | 29.78   | 80     | 10          | 100 |
| YT-1597* | 19       | 28.98   | 29.80   | 80     | 10          | 100 |
| YT-1598  | 21       | 31.70   | 29.90   | 80     | 10          | 80  |
| YT-1599  | 24       | 34.75   | 30.10   | 80     | 10          | 80  |

\* - product not for european market  
\* - produkt nieprzeznaczony na rynek europejski

# Impact sockets, accessories & sets Udarowe klucze nasadowe, akcesoria i zestawy



3

- GB Impact extension bar
- D Verlängerung
- PL Przedłużka udarowa
- RUS Удлинитель ударный
- CZ Prodlužovací přípravek
- H Toldalék
- RO Prelungitor
- E Tubo de prolongación

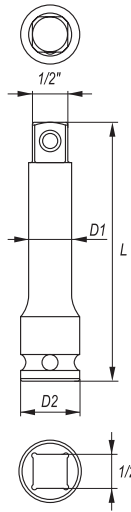

1/2"  
12.5 mm  
CrMo  
SCM-440

COLOR BOX



| YATO    | Ø              | D1 (mm) | D2 (mm) | L (mm) | PCS packing: | Box |
|---------|----------------|---------|---------|--------|--------------|-----|
| YT-1060 | 1/2" (12.7 mm) | 17.5    | 25.0    | 75     | 40           | 160 |
| YT-1061 | 1/2" (12.7 mm) | 18.5    | 25.0    | 125    | 28           | 112 |
| YT-1062 | 1/2" (12.7 mm) | 20.0    | 25.0    | 250    | 30           | 60  |

- GB Impact extension bar
- D Verlängerung
- PL Przedłużka udarowa
- RUS Удлинитель ударный
- CZ Prodlužovací přípravek
- H Toldalék
- RO Prelungitor
- E Tubo de prolongación

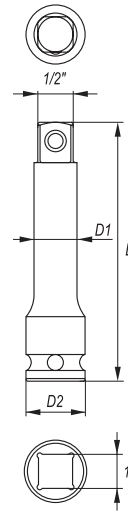

1/2"  
12.5 mm  
CrV

COLOR BOX



\* - product not for european market  
\* - produkt nieprzeznaczony na rynek europejski

| YATO     | Ø              | D1 (mm) | D2 (mm) | L (mm) | PCS packing: | Box |
|----------|----------------|---------|---------|--------|--------------|-----|
| YT-1807  | 1/2" (12.7 mm) | 16.0    | 23.0    | 75     | 12           | 144 |
| YT-1808* | 1/2" (12.7 mm) | 16.0    | 23.0    | 125    | 10           | 100 |
| YT-1809  | 1/2" (12.7 mm) | 16.0    | 23.0    | 250    | 10           | 60  |

- GB Impact adapter
- D Reduktion
- PL Redukcja udarowa
- RUS Переходник
- CZ Redukce
- H Redukció
- RO Reducție
- E Reducció

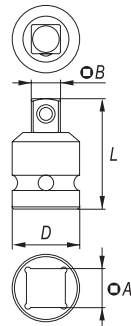

1/2"  
12.5 mm  
CrMo  
SCM-440

COLOR BOX



| YATO    | Ø                  | Ø                  | D (mm) | L (mm) | PCS packing: | Box |
|---------|--------------------|--------------------|--------|--------|--------------|-----|
| YT-1067 | 1/2" (12.7 mm) (F) | 3/4" (19.0 mm) (M) | 30     | 48     | 40           | 160 |

- GB Impact universal joint
- D Gelenkstück
- PL Przegub kulisty udarowy
- RUS Кардан ударный
- CZ Kloub kulový
- H Univerzális csuklós csatlakozó
- RO Adaptor
- E Articulación redonda

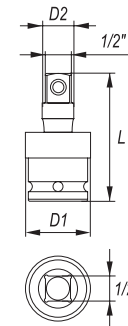

1/2"  
12.5 mm  
CrMo  
SCM-440

COLOR BOX



| YATO    | Ø              | D1 (mm) | D2 (mm) | L (mm) | PCS packing: | Box |
|---------|----------------|---------|---------|--------|--------------|-----|
| YT-1064 | 1/2" (12.7 mm) | 31      | 17      | 63     | 25           | 100 |

- GB Universal joint
- D Kardangelen
- PL Przegub Cardana
- RUS Карданный шарнир
- CZ Kardanový kloub
- H Kardán csukló
- RO Articulație Cardanică
- E Articulación Cardan

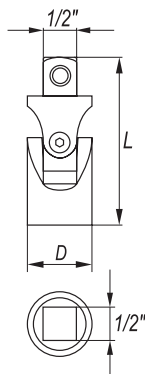

1/2"  
12.5 mm  
CrV

COLOR BOX



| YATO    | Ø              | D (mm) | L (mm) | PCS packing: | Box |
|---------|----------------|--------|--------|--------------|-----|
| YT-1804 | 1/2" (12.7 mm) | 24.0   | 76.6   | 10           | 120 |

- GB Hexagonal impact socket
- D Kraftschrauber-Einsatz
- PL Nasadka uderowa sześciokątna
- RUS Головка ударная 6-гранная
- CZ Šestihranný nástavec
- H Hatszögű rátét
- RO Cheie tubulară hexagonală de impact
- E Boquilla de percusión

COLOR BOX



**3/4"** CrMo SCM-440  
**19 mm** AS-DRIVE

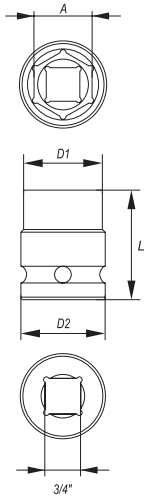

| YATO     | ∅ A (mm) | D1 (mm) | D2 (mm) | L (mm) | PCS packing: |    |
|----------|----------|---------|---------|--------|--------------|----|
| YT-1081* | 18       | 31      | 40      | 50     | 16           | 64 |
| YT-1070  | 19       | 32      | 40      | 50     | 16           | 64 |
| YT-1071  | 21       | 35      | 40      | 50     | 16           | 64 |
| YT-1072  | 22       | 38      | 40      | 50     | 16           | 64 |
| YT-1073  | 23       | 38      | 40      | 50     | 16           | 64 |
| YT-1074  | 24       | 40      | 40      | 50     | 16           | 64 |
| YT-1075  | 25       | 40      | 40      | 50     | 16           | 64 |
| YT-1076  | 26       | 40      | 40      | 50     | 16           | 64 |
| YT-1077  | 27       | 42      | 42      | 53     | 16           | 64 |
| YT-1078  | 28       | 44      | 44      | 53     | 16           | 64 |
| YT-1079  | 29       | 46      | 44      | 53     | 12           | 48 |
| YT-1080  | 30       | 46      | 44      | 53     | 12           | 48 |
| YT-1082  | 32       | 48      | 44      | 56     | 12           | 48 |
| YT-1083  | 33       | 48      | 44      | 56     | 8            | 32 |
| YT-1084  | 34       | 50      | 44      | 56     | 8            | 32 |
| YT-1085  | 35       | 50      | 44      | 56     | 6            | 24 |
| YT-1086  | 36       | 52      | 44      | 56     | 6            | 24 |
| YT-1088  | 38       | 56      | 44      | 57     | 6            | 24 |
| YT-1091  | 41       | 60      | 44      | 57     | 5            | 20 |
| YT-1092  | 42       | 61      | 44      | 57     | 4            | 16 |
| YT-1093  | 43       | 63      | 44      | 57     | 4            | 16 |
| YT-1096  | 46       | 66      | 44      | 62     | 3            | 12 |
| YT-1098  | 48       | 68      | 44      | 67     | 3            | 12 |
| YT-1100  | 50       | 71      | 54      | 72     | 3            | 12 |
| YT-1102  | 52       | 74      | 54      | 72     | 2            | 8  |
| YT-1105  | 55       | 78      | 54      | 74     | 2            | 8  |
| YT-1110  | 60       | 84      | 54      | 74     | 2            | 8  |

\* - product not for european market  
\* - produkt nieprzeznaczony na rynek europejski

- GB Impact socket set
- D Kraftschrauber-Einsätze
- PL Zestaw nasadek uderowych
- RUS Набор торцевых ударных головок
- CZ Sada nástrčných klíčů pro úderové utahováky

- H Dugófej készlet ütvebehajtóhoz
- RO Set chei tubulare pt. impact
- E Juego de boquillas de percusión cortas



METAL CASE & COLOR BOX

**8 PCS** **3/4"** CrMo SCM-440  
**19 mm** AS-DRIVE



3/4" (19.0 mm): 22, 24 mm (L=50 mm); 27, 30 mm (L=53 mm); 32, 36 mm (L=55 mm); 38, 41 mm (L=57 mm)

| YATO    | ∅              |   |
|---------|----------------|---|
| YT-1115 | 3/4" (19.0 mm) | 6 |

- GB Hexagonal deep impact socket
- D Kraftschrauber-Einsatz, lang
- PL Nasadka uderowa sześciokątna długa
- RUS Головка ударная 6-гранная глубокая
- CZ Šestihranný hluboký nástavec
- H Hatszögű rátét mély
- RO Cheie tubulară hexagonală de impact adâncă
- E Boquilla de percusión profunda

COLOR BOX



**3/4"** CrMo SCM-440  
**19 mm** AS-DRIVE

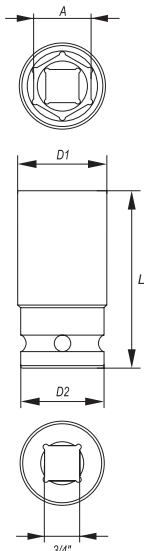

| YATO     | ∅ A (mm) | D1 (mm) | D2 (mm) | L (mm) | PCS packing: |    |
|----------|----------|---------|---------|--------|--------------|----|
| YT-1118* | 18       | 31      | 44      | 90     | 9            | 36 |
| YT-1119  | 19       | 32      | 44      | 90     | 9            | 36 |
| YT-1121  | 21       | 35      | 44      | 90     | 9            | 36 |
| YT-1122  | 22       | 38      | 44      | 90     | 9            | 36 |
| YT-1123  | 23       | 38      | 44      | 90     | 9            | 36 |
| YT-1124  | 24       | 40      | 44      | 90     | 9            | 36 |
| YT-1125  | 25       | 40      | 44      | 90     | 9            | 36 |
| YT-1126  | 26       | 40      | 44      | 90     | 9            | 36 |
| YT-1127  | 27       | 42      | 44      | 90     | 9            | 36 |
| YT-1128  | 28       | 44      | 44      | 90     | 8            | 32 |
| YT-1129  | 29       | 44      | 44      | 90     | 8            | 32 |
| YT-1130  | 30       | 46      | 44      | 90     | 7            | 28 |
| YT-1132  | 32       | 48      | 44      | 90     | 7            | 28 |
| YT-1133  | 33       | 50      | 44      | 90     | 6            | 24 |
| YT-1134  | 34       | 51      | 44      | 90     | 6            | 24 |
| YT-1135  | 35       | 52      | 44      | 90     | 6            | 24 |
| YT-1136  | 36       | 54      | 44      | 90     | 6            | 24 |
| YT-1138  | 38       | 56      | 44      | 90     | 6            | 24 |
| YT-1141  | 41       | 60      | 44      | 90     | 5            | 20 |
| YT-1142  | 42       | 61      | 44      | 90     | 4            | 16 |
| YT-1143  | 43       | 63      | 44      | 90     | 3            | 12 |
| YT-1146  | 46       | 66      | 44      | 90     | 3            | 12 |
| YT-1148  | 48       | 68      | 44      | 90     | 2            | 8  |
| YT-1150  | 50       | 71      | 54      | 90     | 2            | 8  |

\* - product not for european market  
\* - produkt nieprzeznaczony na rynek europejski

# Impact sockets, accessories & sets Udarowe klucze nasadowe, akcesoria i zestawy



GB Impact socket set  
D Kraftschrauber-Einsätze  
PL Zestaw nasadek udarowych  
RUS Набор торцевых ударных головок  
CZ Sada nástrčných klíčů pro úderové utahováky

H Dugófej készlet ütvebehajtóhoz  
RO Set chei tubulare pt. impact  
E Juego de boquillas de percusión cortas



METAL CASE & COLOR BOX

|          |      |                 |
|----------|------|-----------------|
| 8<br>PCS | 3/4" | CrMo<br>SCM-440 |
| 19<br>mm |      | AS-DRIVE        |



3/4" (19.0 mm): 22, 24, 27, 30, 32, 36, 38, 41 mm (L=90 mm)

|         |                |   |
|---------|----------------|---|
| YATO    |                |   |
| YT-1155 | 3/4" (19.0 mm) | 4 |

GB Impact extension bar  
D Verlängerung  
PL Przedłużka udarowa  
RUS Удлинитель ударный  
CZ Prodlužovací přípravek  
H Toldalék  
RO Prelungitor  
E Tubo de prolongación

3/4"  
19  
mm  
CrMo  
SCM-440

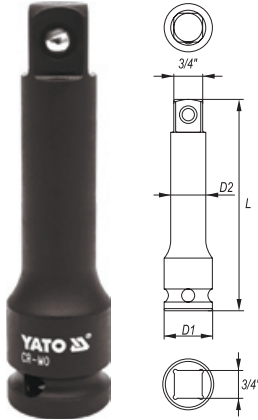

COLOR BOX

| YATO    | Ø              | D1 (mm) | D2 (mm) | L (mm) | PCS packing: |    |
|---------|----------------|---------|---------|--------|--------------|----|
| YT-1160 | 3/4" (19.0 mm) | 44      | 24      | 100    | 8            | 32 |
| YT-1161 | 3/4" (19.0 mm) | 44      | 24      | 175    | 10           | 20 |
| YT-1162 | 3/4" (19.0 mm) | 44      | 24      | 250    | 8            | 16 |
| YT-1163 | 3/4" (19.0 mm) | 44      | 24      | 330    | 6            | 12 |

GB Impact extension bar with adapter  
D Verlängerung mit Adapter  
PL Przedłużka udarowa z redukcją  
RUS Удлинитель с редукцией

CZ Prodloužení s redukcí  
H Hosszabbító szár adapterrel  
RO Bara extensie cu adaptor  
E Tubo de prolongación con reductor

3/4"  
19  
mm  
CrMo  
SCM-440

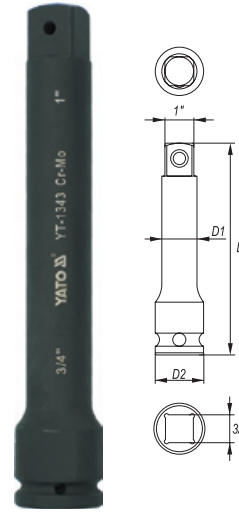

COLOR BOX

| YATO              | Ø A               | Ø B              | D1 (mm) | D2 (mm) | L (mm) | PCS packing: |    |
|-------------------|-------------------|------------------|---------|---------|--------|--------------|----|
| YT-1170 (YT-1343) | 3/4" (19.0mm) (F) | 1" (25.4 mm) (M) | 44      | 33      | 250    | 3            | 12 |

GB Impact adapter  
D Reduktion  
PL Redukcja udarowa  
RUS Переходник  
CZ Redukce  
H Redukció  
RO Reducție  
E Reducción

3/4"  
19  
mm  
CrMo  
SCM-440

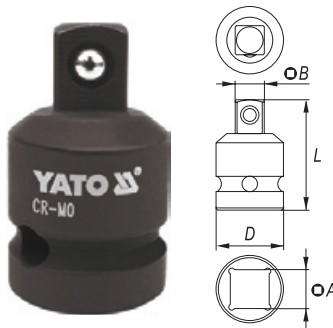

COLOR BOX

| YATO    | Ø                  | Ø                  | D (mm) | L (mm) | PCS packing: |    |
|---------|--------------------|--------------------|--------|--------|--------------|----|
| YT-1167 | 3/4" (19.0 mm) (F) | 1/2" (12.7 mm) (M) | 44     | 56     | 12           | 48 |
| YT-1168 | 3/4" (19.0 mm) (F) | 1" (25.4 mm) (M)   | 44     | 63     | 12           | 48 |

GB Impact universal joint  
D Gelenkstück  
PL Przegub kulisty udarowy  
RUS Кардан ударный  
CZ Kloub kulový  
H Univerzális csuklós csatlakozó  
RO Adaptor  
E Articulación redonda

3/4"  
19  
mm  
CrMo  
SCM-440



COLOR BOX

| YATO    | Ø              | D1 (mm) | D2 (mm) | L (mm) | PCS packing: |    |
|---------|----------------|---------|---------|--------|--------------|----|
| YT-1164 | 3/4" (19.0 mm) | 31      | 44      | 102    | 8            | 32 |

- GB Hexagonal impact socket
- D Kraftschrauber-Einsatz
- PL Nasadka uderowa sześciokątna
- RUS Головка ударная 6-гранная
- CZ Šestihřanný nástavec
- H Hatszögű rátét
- RO Cheie tubulară hexagonală de impact
- E Boquilla de percusión

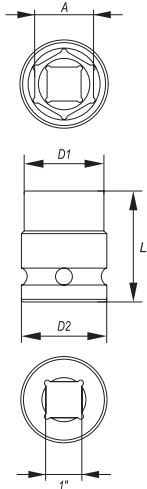

COLOR BOX



**1"** CrMo SCM-440  
**25.4 mm** AS-DRIVE

| YATO    | ∅ A (mm) | D1 (mm) | D2 (mm) | L (mm) | PCS packing: |    |
|---------|----------|---------|---------|--------|--------------|----|
| YT-1180 | 24       | 42      | 54      | 59     | 6            | 24 |
| YT-1181 | 25       | 43      | 54      | 59     | 6            | 24 |
| YT-1182 | 26       | 43      | 54      | 59     | 6            | 24 |
| YT-1183 | 27       | 46      | 54      | 59     | 6            | 24 |
| YT-1184 | 28       | 47      | 54      | 59     | 6            | 24 |
| YT-1185 | 29       | 48      | 54      | 60     | 6            | 24 |
| YT-1186 | 30       | 49      | 54      | 60     | 6            | 24 |
| YT-1187 | 32       | 52      | 54      | 61     | 6            | 24 |
| YT-1188 | 33       | 53      | 54      | 61     | 6            | 24 |
| YT-1189 | 34       | 54      | 54      | 61     | 6            | 24 |
| YT-1190 | 35       | 56      | 54      | 61     | 6            | 24 |
| YT-1191 | 36       | 57      | 54      | 65     | 6            | 24 |
| YT-1192 | 37       | 58      | 54      | 65     | 6            | 24 |
| YT-1193 | 38       | 60      | 54      | 65     | 5            | 20 |
| YT-1194 | 41       | 63      | 54      | 65     | 4            | 16 |
| YT-1195 | 43       | 65      | 54      | 68     | 4            | 16 |
| YT-1196 | 46       | 69      | 54      | 73     | 3            | 12 |
| YT-1197 | 48       | 72      | 54      | 73     | 2            | 8  |
| YT-1198 | 50       | 75      | 54      | 73     | 2            | 8  |

- GB Hexagonal deep impact socket
- D Kraftschrauber-Einsatz, lang
- PL Nasadka uderowa sześciokątna długa
- RUS Головка ударная 6-гранная глубокая
- CZ Šestihřanný hluboký nástavec
- H Hatszögű rátét mély
- RO Cheie tubulară hexagonală de impact adâncă
- E Boquilla de percusión profunda

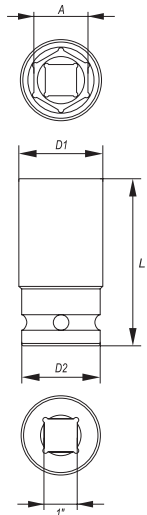

COLOR BOX



**1"** CrMo SCM-440  
**25.4 mm** AS-DRIVE

| YATO    | ∅ A (mm) | D1 (mm) | D2 (mm) | L (mm) | PCS packing: |    |
|---------|----------|---------|---------|--------|--------------|----|
| YT-1175 | 27       | 46      | 54      | 90     | 6            | 24 |
| YT-1176 | 30       | 50      | 54      | 90     | 6            | 24 |
| YT-1177 | 32       | 52      | 54      | 90     | 6            | 24 |
| YT-1178 | 33       | 54      | 54      | 90     | 6            | 24 |
| YT-1179 | 36       | 57      | 54      | 90     | 6            | 24 |

- GB Impact extension bar with adapter
- D Verlängerung mit Adapter
- PL Przedłużka uderowa z redukcją
- RUS Удлинитель с редукцией
- CZ Prodloužení s redukcí
- H Hosszabbító szár adapterrel
- RO Bara extensie cu adaptor
- E Tubo de prolongación con reductor

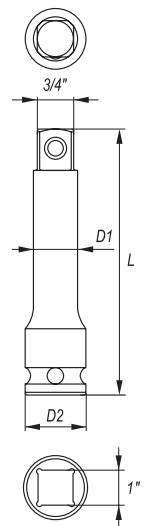

COLOR BOX



**1"**  
**25.4 mm**  
CrMo SCM-440

| YATO    | ∅ A              | ∅ B               | D1 (mm) | D2 (mm) | L (mm) | PCS packing: |    |
|---------|------------------|-------------------|---------|---------|--------|--------------|----|
| YT-1169 | 1" (25.4 mm) (F) | 3/4" (19.0mm) (M) | 53      | 33      | 250    | 6            | 12 |

# Impact sockets, accessories & sets Udarowe klucze nasadowe, akcesoria i zestawy



- GB Hexagonal impact socket  
D Kraftschrauber-Einsatz  
PL Nasadka udarowa sześciokątna  
RUS Головка ударная 6-гранная  
CZ Šestihranný nástavec  
H Hatszögű rátét  
RO Cheie tubulară hexagonală de impact  
E Boquilla de percusión

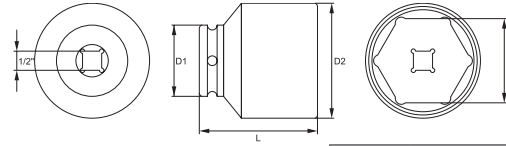

COLOR BOX



|          |                             |
|----------|-----------------------------|
| 1/2"     | FOR FRONT HUB NUTS DO PIAST |
| 12.5 mm  | CrMo SCM-440                |
| AS-DRIVE |                             |

| YATO    | Ø A (mm) | D1 (mm) | D2 (mm) | L (mm) | PCS packing |    |
|---------|----------|---------|---------|--------|-------------|----|
| YT-1029 | 52       | 44      | 71      | 72     | 3           | 12 |

- GB Bi-hexagonal impact socket  
D Zwölfkant-Kraftschrauber-Einsatz  
PL Nasadka udarowa dwunastokątna  
RUS Головка ударная 12-гранная  
CZ Vanáctihřanný nástavec  
H Dugófej, 12 lapú  
RO Cheie tubulară bihexagonală de impact  
E Boquilla bihexagonal de percusión

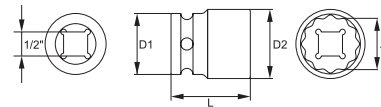

COLOR BOX



|          |                             |
|----------|-----------------------------|
| 1/2"     | FOR FRONT HUB NUTS DO PIAST |
| 12.5 mm  | CrMo SCM-440                |
| AS-DRIVE |                             |

| YATO    | Ø A (mm) | D1 (mm) | D2 (mm) | L (mm) | PCS packing |     |
|---------|----------|---------|---------|--------|-------------|-----|
| YT-1027 | 24       | 30      | 34      | 39     | 10          | 120 |

- GB Bi-hexagonal deep impact socket  
D Zwölfkant-Kraftschrauber-Einsatz, lang  
PL Nasadka udarowa dwunastokątna długa  
RUS Головка ударная 12-гранная глубокая  
CZ Vanáctihřanný hluboký nástavec  
H Dugófej, mély, 12 lapú  
RO Cheie tubulară bihexagonală de impact adâncă  
E Boquilla bihexagonal de percusión profundal

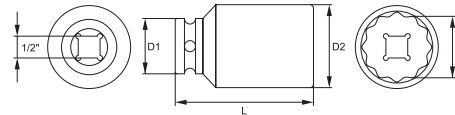

COLOR BOX



|          |                             |
|----------|-----------------------------|
| 1/2"     | FOR FRONT HUB NUTS DO PIAST |
| 12.5 mm  | CrMo SCM-440                |
| AS-DRIVE |                             |

| YATO    | Ø A (mm) | D1 (mm) | D2 (mm) | L (mm) | PCS packing |    |
|---------|----------|---------|---------|--------|-------------|----|
| YT-1028 | 33       | 30      | 45      | 75     | 8           | 32 |

- GB Impact bit socket set  
D Schlagsteckschlüsselsatz  
PL Zestaw udarowych kluczy trzpieniowych  
RUS Набор ударных торцовых ключей  
CZ Souprava rázových zástrčných klíčů  
H Üthető dugókulcs bit - készlet  
RO Set chei de șoc cu bolt  
E Juego de llaves de mandril de impacto



|       |      |         |      |        |
|-------|------|---------|------|--------|
| 8 PCS | 1/2" | 12.5 mm | CrMo | HRC 54 |
|-------|------|---------|------|--------|

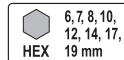

| YATO    | Ø              |    |
|---------|----------------|----|
| YT-1065 | 1/2" (12.7 mm) | 15 |

| YATO    | Ø              |    |
|---------|----------------|----|
| YT-1066 | 1/2" (12.7 mm) | 15 |



| YATO    | Ø              |    |
|---------|----------------|----|
| YT-1068 | 1/2" (12.7 mm) | 15 |

| YATO    | Ø              |    |
|---------|----------------|----|
| YT-1069 | 1/2" (12.7 mm) | 15 |

- GB Spline impact bit set  
D Schlagwerkzeugsatz - Spline  
PL Zestaw bitów udarowych - Spline  
RUS Набор ударных битов - Spline  
CZ Souprava bitů pro rázové utahováky - Spline  
H Útő bit készlet - Spline  
RO Set tubulare de impact  
E Juego de las piezas de precisión - Spline

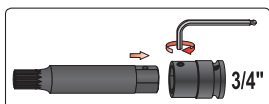

BMC & COLOR BOX



|       |      |              |
|-------|------|--------------|
| 6 PCS | 3/4" | SPLINE (XZN) |
| 19 mm | CrMo |              |

- M12, M14, M16, M18 x 22 mm; (L=107 mm); CrMo;  
◎ 3/4" (19.0 mm) x 22 mm; CrMo;

| YATO    | Ø              |   |
|---------|----------------|---|
| YT-1157 | 3/4" (19.0 mm) | 8 |

# 4

## Torque wrenches & torque multipliers Klucze dynamometryczne i wzmacniacze momentu





Torque wrenches

Klucze dynamometryczne

82-85



Torque angle gauges

Kątomierze do dokręcania śrub

85



Torque wrenches with metal handle

Klucze dynamometryczne z metalową rączką..... 82

Torque wrenches with plastic handle

Klucze dynamometryczne z plastikową rączką..... 82

Digital torque wrenches

Klucze dynamometryczne, cyfrowe..... 84

Torque screwdrivers

Wkrętaki dynamometryczne..... 85

Digital torque screwdrivers

Wkrętaki dynamometryczne, cyfrowe..... 85

Torque multipliers

Wzmacniacze momentu

85



GB Torque wrench  
D Drehmomentschlüssel  
PL Klucz dynamometryczny

RUS Ключ динамометрический  
CZ Dynamometrický klíč  
H Nyomatékkulcs

RO Cheie cu dinamometru  
E Llave dinamométrica



1/2" 3/8"  
12.5 mm 10 mm  
CrV 6140



| YATO    | Ø              | Nm     | L (mm) | ☐  |
|---------|----------------|--------|--------|----|
| YT-0750 | 3/8" (9.5 mm)  | 19-110 | 366    | 20 |
| YT-0760 | 1/2" (12.7 mm) | 42-210 | 470    | 12 |

4

GB Torque wrench  
D Drehmomentschlüssel  
PL Klucz dynamometryczny

RUS Ключ динамометрический  
CZ Dynamometrický klíč  
H Nyomatékkulcs

RO Cheie cu dinamometru  
E Llave dinamométrica



1" 25.4 mm CrV 6140



\* - product not for european market  
\* - produkt nieprzeznaczony na rynek europejski

| YATO     | Ø            | Nm       | L (mm) | ☐ |
|----------|--------------|----------|--------|---|
| YT-0756* | 1" (25.4 mm) | 300-1500 | 1850   | 2 |

GB Torque wrench  
D Drehmomentschlüssel  
PL Klucz dynamometryczny

RUS Ключ динамометрический  
CZ Dynamometrický klíč  
H Nyomatékkulcs

RO Cheie cu dinamometru  
E Llave dinamométrica



3/4" 1/2"  
19 mm 12.5 mm  
CrV 6140



YT-0771  
• application: automotive service stations, trucks  
• wrench and extension pipe designed to tighten screws in double wheels  
• measurement tolerance +/- 3%

YT-0771  
• przeznaczenie: serwisy, samochody ciężarowe  
• łącznie z przedłużką dostosowany do dokręcania śrub w kołach bliźniaczych  
• dokładność pomiarowa +/- 3%

| YATO    | Ø              | Nm      | L (mm) | ☐  |
|---------|----------------|---------|--------|----|
| YT-0761 | 1/2" (12.7 mm) | 40-210  | 535    | 10 |
| YT-0770 | 3/4" (19.0 mm) | 100-500 | 865    | 4  |
| YT-0771 | 3/4" (19.0 mm) | 140-980 | 1230   | 2  |

GB Torque wrench  
D Drehmomentschlüssel  
PL Klucz dynamometryczny

RUS Ключ динамометрический  
CZ Dynamometrický klíč  
H Nyomatékkulcs

RO Cheie cu dinamometru  
E Llave dinamométrica



1" 3/4" 1/2" 3/8" 1/4"  
25.4 mm 19 mm 12.5 mm 10 mm 6.3 mm  
CrV 6140



\* - product not for european market  
\* - produkt nieprzeznaczony na rynek europejski

| YATO      | Ø              | Nm     | L (mm) | ☐  |
|-----------|----------------|--------|--------|----|
| YT-07410* | 1/4" (6.3 mm)  | 5-25   | 290    | 10 |
| YT-07411* | 3/8" (9.5 mm)  | 10-50  | 360    | 10 |
| YT-07412* | 3/8" (9.5 mm)  | 20-100 | 405    | 10 |
| YT-07413* | 1/2" (12.7 mm) | 20-100 | 405    | 10 |
| YT-07414* | 1/2" (12.7 mm) | 40-200 | 500    | 10 |
| YT-07415* | 1/2" (12.7 mm) | 60-300 | 595    | 10 |

| YATO      | Ø              | Nm       | L (mm) | ☐  |
|-----------|----------------|----------|--------|----|
| YT-07416* | 1/2" (12.7 mm) | 80-400   | 680    | 10 |
| YT-07417* | 3/4" (19.0 mm) | 100-550  | 970    | 2  |
| YT-07418* | 3/4" (19.0 mm) | 150-750  | 1150   | 2  |
| YT-07419* | 1" (25.4 mm)   | 150-750  | 1150   | 2  |
| YT-07420* | 1" (25.4 mm)   | 300-1000 | 1250   | 2  |

GB Torque wrench  
D Drehmomentschlüssel  
PL Klucz dynamometryczny

RUS Ключ динамометрический  
CZ Dynamometrický klíč  
H Nyomatékkulcs

RO Cheie cu dinamometru  
E Llave dinamométrica



3/8" 1/4"  
10 mm 6.3 mm  
CrV 6140



\* - product not for european market  
\* - produkt nieprzeznaczony na rynek europejski

| YATO     | Ø             | Nm     | L (mm) | ☐  |
|----------|---------------|--------|--------|----|
| YT-0751  | 1/4" (6.3 mm) | 2-10   | 281    | 24 |
| YT-0752* | 3/8" (9.5 mm) | 4-20   | 325    | 24 |
| YT-0753* | 3/8" (9.5 mm) | 20-100 | 435    | 12 |

GB Torque wrench  
D Drehmomentschlüssel  
PL Klucz dynamometryczny

RUS Ключ динамометрический  
CZ Dynamometrický klíč  
H Nyomatékkulcs

RO Cheie cu dinamometru  
E Llave dinamométrica



1" 3/4" 1/2" 3/8" 1/4"  
25.4 mm 19 mm 12.5 mm 10 mm 6.3 mm  
CrV 6140



\* - product not for european market  
\* - produkt nieprzeznaczony na rynek europejski

| YATO      | Ø              | Nm     | L (mm) | ☐  |
|-----------|----------------|--------|--------|----|
| YT-07401* | 1/4" (6.3 mm)  | 4-20   | 322    | 24 |
| YT-07402* | 3/8" (9.5 mm)  | 10-60  | 337    | 24 |
| YT-07403* | 1/2" (12.7 mm) | 20-100 | 436    | 12 |
| YT-07404* | 1/2" (12.7 mm) | 40-200 | 512    | 10 |

| YATO      | Ø              | Nm       | L (mm) | ☐ |
|-----------|----------------|----------|--------|---|
| YT-07405* | 3/4" (19.0 mm) | 100-600  | 1050   | 2 |
| YT-07406* | 3/4" (19.0 mm) | 150-800  | 1240   | 2 |
| YT-07407* | 1" (25.4 mm)   | 150-800  | 1240   | 2 |
| YT-07408* | 1" (25.4 mm)   | 200-1000 | 1240   | 2 |

# Torque wrenches & torque multipliers Klucze dynamometryczne i wzmacniacze momentu



GB Torque wrench  
D Drehmomentschlüssel  
PL Klucz dynamometryczny

RUS Ключ динамометрический  
CZ Dynamometrický klíč  
H Nyomatékkulcs

RO Cheie cu dinamometru  
E Llave dinamométrica



3/4" 1/2"  
19 mm 12.5 mm  
CrV 6140



| YATO    | Ø              | Nm       | L (mm) | ☐  |
|---------|----------------|----------|--------|----|
| YT-0754 | 1/2" (12.7 mm) | 60-340   | 613    | 10 |
| YT-0755 | 3/4" (19.0 mm) | 200-1000 | 1234   | 2  |

GB Interchangeable torque handle  
D Handgriff eines dynamometrischen Schlüssels  
PL Rękojeść klucza dynamometrycznego

RUS Рукоятка динамометрического ключа  
CZ Rukojeť dynamometrického klíče  
H Nyomatékkulcs nyél

RO Mâner pt. cheie dinamometrică  
E Mango de llave dinamométrica



CrV 6140



\* - product not for european market  
\* - produkt nieprzeznaczony na rynek europejski

| YATO      | ☒    | Nm     | L (mm) | ☐  |
|-----------|------|--------|--------|----|
| YT-07421* | 9x12 | 2-10   | 260    | 25 |
| YT-07422* | 9x12 | 4-20   | 310    | 25 |
| YT-07423* | 9x12 | 4.5-30 | 310    | 25 |
| YT-07424* | 9x12 | 10-60  | 310    | 25 |
| YT-07425* | 9x12 | 20-100 | 430    | 16 |

| YATO      | ☒     | Nm     | L (mm) | ☐  |
|-----------|-------|--------|--------|----|
| YT-07426* | 9x12  | 25-125 | 430    | 16 |
| YT-07427* | 14x18 | 20-100 | 430    | 16 |
| YT-07428* | 14x18 | 40-200 | 505    | 9  |
| YT-07429* | 14x18 | 60-340 | 555    | 9  |

GB Open box-end insert tool  
D Steckschlüssel, flach  
PL Klucz wtykowy płaski  
RUS Съёмный плоский гаечный ключ  
CZ Klíč vidlicový nástrčný  
H Feltűző villáskulcs  
RO Cheie mufă plată  
E Cabeza de llave de boca abierta

CrV 6140



\* - product not for european market  
\* - produkt nieprzeznaczony na rynek europejski

| YATO      | ☒     | size / rozmiar (mm) | ☐   |
|-----------|-------|---------------------|-----|
| YT-07432* | 9x12  | 7                   | 300 |
| YT-07433* | 9x12  | 8                   | 300 |
| YT-07434* | 9x12  | 9                   | 300 |
| YT-07435* | 9x12  | 10                  | 300 |
| YT-07436* | 9x12  | 11                  | 300 |
| YT-07437* | 9x12  | 12                  | 300 |
| YT-07438* | 9x12  | 13                  | 300 |
| YT-07439* | 9x12  | 14                  | 300 |
| YT-07440* | 9x12  | 15                  | 300 |
| YT-07441* | 9x12  | 16                  | 250 |
| YT-07442* | 9x12  | 17                  | 250 |
| YT-07443* | 9x12  | 18                  | 220 |
| YT-07444* | 9x12  | 19                  | 220 |
| YT-07445* | 14x18 | 13                  | 120 |
| YT-07446* | 14x18 | 14                  | 120 |
| YT-07447* | 14x18 | 15                  | 120 |
| YT-07448* | 14x18 | 16                  | 120 |
| YT-07449* | 14x18 | 17                  | 120 |
| YT-07450* | 14x18 | 18                  | 100 |
| YT-07451* | 14x18 | 19                  | 100 |
| YT-07452* | 14x18 | 21                  | 100 |
| YT-07453* | 14x18 | 22                  | 100 |
| YT-07454* | 14x18 | 24                  | 100 |
| YT-07455* | 14x18 | 27                  | 70  |
| YT-07456* | 14x18 | 30                  | 60  |
| YT-07457* | 14x18 | 32                  | 60  |
| YT-07458* | 14x18 | 34                  | 60  |
| YT-07459* | 14x18 | 36                  | 60  |
| YT-07460* | 14x18 | 38                  | 60  |
| YT-07461* | 14x18 | 41                  | 50  |

GB Box-end insert tool  
D Maul-Steckschlüssel  
PL Klucz wtykowy oczkowy  
RUS Съёмный накидной гаечный ключ  
CZ Klíč očkový nástrčný  
H Feltűző csillagkulcs  
RO Cheie mufă ochi  
E Cabeza de llave de anillo

CrV 6140



\* - product not for european market  
\* - produkt nieprzeznaczony na rynek europejski

| YATO      | ☒     | size / rozmiar (mm) | ☐   |
|-----------|-------|---------------------|-----|
| YT-07465* | 9x12  | 7                   | 300 |
| YT-07466* | 9x12  | 8                   | 300 |
| YT-07467* | 9x12  | 10                  | 300 |
| YT-07468* | 9x12  | 11                  | 300 |
| YT-07469* | 9x12  | 12                  | 300 |
| YT-07470* | 9x12  | 13                  | 300 |
| YT-07471* | 9x12  | 14                  | 300 |
| YT-07472* | 9x12  | 15                  | 300 |
| YT-07473* | 9x12  | 16                  | 300 |
| YT-07474* | 9x12  | 17                  | 280 |
| YT-07475* | 9x12  | 18                  | 280 |
| YT-07476* | 9x12  | 19                  | 220 |
| YT-07477* | 9x12  | 21                  | 220 |
| YT-07478* | 9x12  | 22                  | 220 |
| YT-07479* | 14x18 | 13                  | 120 |
| YT-07480* | 14x18 | 14                  | 120 |
| YT-07481* | 14x18 | 15                  | 120 |
| YT-07482* | 14x18 | 16                  | 120 |
| YT-07483* | 14x18 | 17                  | 120 |
| YT-07484* | 14x18 | 18                  | 120 |
| YT-07485* | 14x18 | 19                  | 120 |
| YT-07486* | 14x18 | 21                  | 100 |
| YT-07487* | 14x18 | 22                  | 100 |
| YT-07488* | 14x18 | 24                  | 100 |
| YT-07489* | 14x18 | 27                  | 100 |
| YT-07490* | 14x18 | 30                  | 80  |
| YT-07491* | 14x18 | 32                  | 80  |
| YT-07492* | 14x18 | 34                  | 80  |
| YT-07493* | 14x18 | 36                  | 80  |
| YT-07494* | 14x18 | 41                  | 60  |

GB Insert reversible ratchet  
D Steckratsenschlüssel  
PL Grzechotka wtykowa  
RUS Трещотка вставная  
CZ Račna nástrčna  
H Racsnis csavarhúzó  
RO Clichet cu mufă  
E Cabezal de matraca sellado

3/4" 1/2" 3/8"  
19 mm 12.5 mm 10 mm  
CrV 6140 1/4" 6.3 mm



\* - product not for european market  
\* - produkt nieprzeznaczony na rynek europejski

| YATO      | Ø              | ☒     | ☐   |
|-----------|----------------|-------|-----|
| YT-07495* | 1/4" (6.3 mm)  | 9x12  | 220 |
| YT-07496* | 3/8" (9.5 mm)  | 9x12  | 100 |
| YT-07497* | 1/2" (12.7 mm) | 9x12  | 100 |
| YT-07498* | 1/2" (12.7 mm) | 14x18 | 50  |
| YT-07499* | 3/4" (19.0 mm) | 14x18 | 50  |

GB Insert adapter for gear wrench  
D Schlüsseladapter  
PL Adaptor do klucza  
RUS Адаптер для ключа  
CZ Adaptér na klíč  
H Kulcs adapter  
RO Adaptor pt. cheie  
E Adaptador para llave

1/2" 3/8" 1/4"  
12.5 mm 10 mm 6.3 mm  
CrV 6140



\* - product not for european market  
\* - produkt nieprzeznaczony na rynek europejski

| YATO      | Ø              | for wrench / do klucza (mm) | ☐   |
|-----------|----------------|-----------------------------|-----|
| YT-07531* | 1/4" (6.3 mm)  | 10                          | 300 |
| YT-07532* | 3/8" (9.5 mm)  | 13                          | 300 |
| YT-07533* | 1/2" (12.7 mm) | 19                          | 300 |

GB Torque wrench  
D Drehmomentschlüssel  
PL Klucz dynamometryczny

RUS Ключ динамометрический  
CZ Dynamometrický klíč  
H Nyomatékkulcs

RO Cheie cu dinamometru  
E Llave dinamométrica



|  |                |           |
|--|----------------|-----------|
|  | 1/2" (12.7 mm) | CrMo 4140 |
|  | 14x18 mm       | 40-210 Nm |
|  |                | CrV 6140  |



\* - product not for european market  
\* - produkt nieprzeznaczony na rynek europejski

| YATO     | Ø              | Nm     | L (mm) | Box |
|----------|----------------|--------|--------|-----|
| YT-0767* | 1/2" (12.7 mm) | 40-210 | 500    | 4   |

GB Digital torque wrench  
D Elektronischer Drehmomentschlüssel  
PL Elektroniczny klucz dynamometryczny

RUS Электронный динамометрический ключ  
CZ Elektronický dynamometrický klíč  
H Elektronikus dinamométeres kulcs

RO Cheie dinamometrica electronica  
E Llave dinamométrica electronica



|         |                                |             |      |
|---------|--------------------------------|-------------|------|
| 1/2"    | LCD DISPLAY                    | COLOR LEDS  | BEEP |
| 12.5 mm | QUICK RELEASE SZYBKO-ZŁĄCZACZE | 2x1.5V (AA) |      |

- application: industry, service stations
- precise digital torque measurement
- internal memory
- certificate of calibration
- accuracy 2%

- przeznaczenie: przemysł, serwis ogólnomechaniczny, serwis opon
- precyzyjny, cyfrowy pomiar momentu dokręcającego
- pamięć wewnętrzna
- certyfikat kalibracji
- dokładność 2%

| YATO    | Ø              | Nm    | L (mm) | Box |
|---------|----------------|-------|--------|-----|
| YT-0762 | 1/2" (12.7 mm) | 2-203 | 450    | 10  |

GB Digital torque wrench  
D Elektronischer Drehmomentschlüssel  
PL Elektroniczny klucz dynamometryczny  
RUS Электронный динамометрический ключ

CZ Elektronický dynamometrický klíč  
H Elektronikus dinamométeres kulcs  
RO Cheie dinamometrica electronica  
E Llave dinamométrica electronica

BMC & COLOR SLEEVE



|         |                                |                                   |      |
|---------|--------------------------------|-----------------------------------|------|
| 1/2"    | LCD DISPLAY                    | COLOR LEDS                        | BEEP |
| 12.5 mm | QUICK RELEASE SZYBKO-ZŁĄCZACZE | ANGLE RANGE 0-360° KĄT DOKRĘCANIA |      |
| 72T     | 4x1.5V (AAA)                   |                                   |      |

- application: industry, service stations
- precise digital torque measurement
- internal memory
- certificate of calibration
- accuracy 2%

- przeznaczenie: przemysł, serwis ogólnomechaniczny, serwis opon
- precyzyjny, cyfrowy pomiar momentu dokręcającego
- pamięć wewnętrzna
- certyfikat kalibracji
- dokładność 2%

| YATO    | Ø              | Nm     | L (mm) | Box |
|---------|----------------|--------|--------|-----|
| YT-0763 | 1/2" (12.7 mm) | 20-200 | 600    | 8   |

GB Digital torque wrench  
D Elektronischer Drehmomentschlüssel  
PL Elektroniczny klucz dynamometryczny  
RUS Электронный динамометрический ключ

CZ Elektronický dynamometrický klíč  
H Elektronikus dinamométeres kulcs  
RO Cheie dinamometrica electronica  
E Llave dinamométrica electronica



\* - product not for european market  
\* - produkt nieprzeznaczony na rynek europejski



|          |       |
|----------|-------|
| 1/2"     | 3/8"  |
| 12.5 mm  | 10 mm |
| CrV 6140 |       |

| YATO      | Ø              | Nm     | L (mm) | Box |
|-----------|----------------|--------|--------|-----|
| YT-07501* | 3/8" (9.5 mm)  | 10-135 | 394    | 6   |
| YT-07502* | 3/8" (9.5 mm)  | 20-200 | 569    | 6   |
| YT-07503* | 1/2" (12.7 mm) | 10-135 | 394    | 6   |

| YATO      | Ø              | Nm     | L (mm) | Box |
|-----------|----------------|--------|--------|-----|
| YT-07504* | 1/2" (12.7 mm) | 20-200 | 569    | 6   |
| YT-07505* | 1/2" (12.7 mm) | 34-340 | 769    | 4   |

GB Digital torque wrench  
D Elektronischer Drehmomentschlüssel  
PL Elektroniczny klucz dynamometryczny  
RUS Электронный динамометрический ключ

CZ Elektronický dynamometrický klíč  
H Elektronikus dinamométeres kulcs  
RO Cheie dinamometrica electronica  
E Llave dinamométrica electronica



\* - product not for european market  
\* - produkt nieprzeznaczony na rynek europejski



|          |       |
|----------|-------|
| 1"       | 3/4"  |
| 25.4 mm  | 19 mm |
| CrV 6140 |       |

| YATO      | Ø              | Nm     | L (mm) | Box |
|-----------|----------------|--------|--------|-----|
| YT-07507* | 3/4" (19.0 mm) | 60-600 | 1248   | 1   |
| YT-07513* | 3/4" (19.0 mm) | 80-800 | 1248   | 1   |

| YATO      | Ø              | Nm       | L (mm) | Box |
|-----------|----------------|----------|--------|-----|
| YT-07514* | 3/4" (19.0 mm) | 100-1000 | 1248   | 1   |
| YT-07515* | 1" (25.4 mm)   | 150-1500 | 1248   | 1   |

GB Digital interchangeable torque handle  
D Handgriff eines elektronischen dynamometrischen Schlüssels  
PL Rękojeść elektronicznego klucza dynamometrycznego

RUS Рукоятка электронного динамометрического ключа  
CZ Rukojeť elektronického dynamometrického klíče

H Elektromos nyomatékkulcs nyél  
RO Mâner cheie dinamometrică electrică  
E Mango de llave dinamométrica electrónica



CrV 6140

\* - product not for european market  
\* - produkt nieprzeznaczony na rynek europejski



| YATO      | Ø    | Nm     | L (mm) | Box |
|-----------|------|--------|--------|-----|
| YT-07430* | 9x12 | 10-135 | 365    | 6   |
| YT-07431* | 9x12 | 20-200 | 540    | 6   |

# Torque wrenches & torque multipliers Klucze dynamometryczne i wzmacniacze momentu



GB Torque screwdriver  
D Dynamometrischer Schraubendreher  
PL Wkrętak dynamometryczny  
RUS Динамометрическая отвертка

CZ Dynamometrický šroubovák  
H Dinamométeres csavarhúzó  
RO Mașină de înfiletat dinamometrică  
E Destornillador dinamométrico

PLASTIC  
BOX



1/4"  
6.3  
mm



\* - product not for european market  
\* - produkt nieprzeznaczony na rynek europejski

| YATO      | Ø             | Nm      | L (mm) | Box |
|-----------|---------------|---------|--------|-----|
| YT-07517* | 1/4" (6.3 mm) | 0.1-1.2 | 180    | 24  |
| YT-07518* | 1/4" (6.3 mm) | 1-6     | 248    | 24  |

GB Torque screwdriver  
D Dynamometrischer Schraubendreher  
PL Wkrętak dynamometryczny  
RUS Динамометрическая отвертка

CZ Dynamometrický šroubovák  
H Dinamométeres csavarhúzó  
RO Mașină de înfiletat dinamometrică  
E Destornillador dinamométrico

BMC



1/4"  
6.3  
mm



\* - product not for european market  
\* - produkt nieprzeznaczony na rynek europejski

| YATO      | Ø             | Nm  | L (mm) | Box |
|-----------|---------------|-----|--------|-----|
| YT-07525* | 1/4" (6.3 mm) | 1-5 | 154    | 30  |
| YT-07526* | 1/4" (6.3 mm) | 1-8 | 235    | 30  |

GB Digital torque screwdriver  
D Elektronischer dynamometrischer Schraubendreher  
PL Elektroniczny wkrętak dynamometryczny  
RUS Электронная динамометрическая отвертка

CZ Elektronický dynamometrický šroubovák  
H Elektromos dinaméteres csavarhúzó  
RO Mașină electronică dinamometrică de înfiletat  
E Destornillador dinamométrico electrónico

BMC



1/4"  
6.3  
mm



\* - product not for european market  
\* - produkt nieprzeznaczony na rynek europejski

| YATO      | Ø             | Nm    | L (mm) | Box |
|-----------|---------------|-------|--------|-----|
| YT-07520* | 1/4" (6.3 mm) | 0.3-3 | 215    | 20  |
| YT-07521* | 1/4" (6.3 mm) | 0.6-6 | 215    | 20  |

GB Torque angle gauge  
D Winkelmesser zum Anziehen von Schrauben  
PL Kałomierz do dokręcania śrub  
RUS Угломер для подвёртывания болтов  
CZ Úhloměr k utahování šroubů  
H Nyomaték szögmérő  
RO Raportor pt. înșurubat șuruburi  
E Calibrador para apretar tornillos



SLIDING  
CARD



1/2" 360°  
12.5  
mm CrV

| YATO    | Box   |
|---------|-------|
| YT-0593 | 12/48 |

GB Torque multiplier  
D Drehmomentverstärker  
PL Mechaniczny wzmacniacz momentu  
RUS Мультипликатор крутящего момента

CZ Mechanický posilovač momentu  
H Nyomaték sokszorozó  
RO Antrenor cu amplificator de forta  
E Mecanismo de reforzar el momento

BMC &  
COLOR  
SLEEVE



3:1 □ 1/2" max. 460 Nm ■ 3/4" max. 1400 Nm  
CrMo 4140 □ 3/4" max. 900 Nm ■ 1" max. 2700 Nm

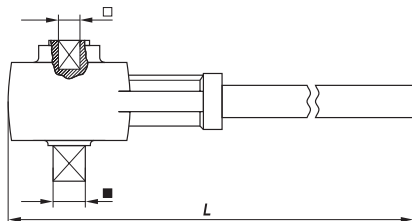

| YATO    | F □            | Tmax. (Nm) | M ■            | Tmax. (Nm) | L (mm) | Box |
|---------|----------------|------------|----------------|------------|--------|-----|
| YT-0780 | 1/2" (12.7 mm) | 460        | 3/4" (19.0 mm) | 1400       | 420    | 6   |
| YT-0781 | 3/4" (19.0 mm) | 900        | 1" (25.4 mm)   | 2700       | 500    | 4   |

GB Labor save wrench  
D Drehmomentverstärker  
PL Mechaniczny wzmacniacz momentu  
RUS Механический усилитель силы  
CZ Mechanický posilovač momentu  
H Nyomaték sokszorozó  
RO Antrenor cu amplificator de forta  
E Mecanismo de reforzar el momento



1" 32,33mm 4200 Nm (max)  
25.4 mm I-1:3.8 II-1:58 CrV

BMC & COLOR SLEEVE



| YATO    | Ø            | Nm   | L (mm) | Box |
|---------|--------------|------|--------|-----|
| YT-0782 | 1" (25.4 mm) | 4200 | 330    | 1   |

# 5

## Screwdrivers & screwdriver bits Wkrętaki i końcówki wkrętakowe



Screwdrivers, 2 color handle  
Wkrętaki, dwukolorowa rączka

88-92



|   |    |
|---|----|
| Slotted screwdrivers<br>Wkrętaki płaskie.....                                   | 88 |
| Phillips screwdrivers<br>Wkrętaki krzyżakowe.....                               | 88 |
| Pozidrive screwdrivers<br>Wkrętaki „Pozidrive”.....                             | 88 |
| Torx screwdrivers<br>Wkrętaki „Torx”.....                                       | 88 |
| Torx Security screwdrivers<br>Wkrętaki „Torx Security”.....                     | 88 |
| Slotted screwdrivers with straight tip<br>Wkrętaki płaskie z wąskim grotem..... | 89 |
| Go-through screwdrivers<br>Wkrętaki do pobijania.....                           | 89 |
| Screwdriver sets<br>Komplety wkrętaków.....                                     | 89 |
| Precision screwdriver sets<br>Zestawy wkrętaków precyzyjnych.....               | 92 |

Screwdrivers, 3 color handle  
Wkrętaki, trój kolorowa rączka

93-94



|   |    |
|---|----|
| Slotted screwdrivers<br>Wkrętaki płaskie.....               | 93 |
| Phillips screwdrivers<br>Wkrętaki krzyżakowe.....           | 93 |
| Pozidrive screwdrivers<br>Wkrętaki „Pozidrive”.....         | 93 |
| Torx screwdrivers<br>Wkrętaki „Torx”.....                   | 93 |
| Torx Security screwdrivers<br>Wkrętaki „Torx Security”..... | 93 |
| Screwdriver sets<br>Komplety wkrętaków.....                 | 94 |

Precision screwdrivers, 3 color handle  
Wkrętaki precyzyjne, trój kolorowa rączka

95



|  |    |
|--|----|
| Precision slotted screwdrivers<br>Wkrętaki precyzyjne płaskie.....       | 95 |
| Precision phillips screwdrivers<br>Wkrętaki precyzyjne krzyżakowe.....   | 95 |
| Precision Pozidrive screwdrivers<br>Wkrętaki precyzyjne „Pozidrive”..... | 95 |
| Precision Torx screwdrivers<br>Wkrętaki precyzyjne „Torx”.....           | 95 |
| Precision screwdriver sets<br>Zestawy wkrętaków precyzyjnych.....        | 95 |

Insulated screwdrivers  
Wkrętaki izolowane

96



|   |    |
|---|----|
| Insulated slotted screwdrivers<br>Wkrętaki izolowane płaskie.....       | 96 |
| Insulated phillips screwdrivers<br>Wkrętaki izolowane krzyżakowe.....   | 96 |
| Insulated Pozidrive screwdrivers<br>Wkrętaki izolowane „Pozidrive”..... | 96 |
| Insulated screwdriver sets<br>Komplety wkrętaków izolowanych.....       | 96 |

Special screwdrivers & impact screwdrivers  
Wkrętaki specjalne i udarowe

97-99



|   |        |
|---|--------|
| Ratchet screwdriver sets<br>Wkrętaki z grzechotką.....                                    | 97     |
| Impact screwdrivers<br>Wkrętaki udarowe.....  | 99     |
| Screwdriver bits<br>Kończówki wkrętakowe.....   | 99-105 |
| Phillips screwdriver bits<br>Kończówki wkrętakowe krzyżakowe.....                         | 99     |
| Torx screwdriver bits<br>Kończówki wkrętakowe „Torx”.....                                 | 99     |
| YATO NON-SLIP SYSTEM screwdriver bits<br>Kończówki wkrętakowe „YATO NON-SLIP SYSTEM”..... | 99     |
| Screwdriver bit sets<br>Zestawy końcówek wkrętakowych.....                                | 100    |

Nut setters

Nasadki magnetyczne do wkrętarek

106



Screwdriver bit holders

Uchwyty do końcówek wkrętakowych

106



Hex & Torx keys & sets

Klucze imbusowe i zestawy

106-111



|  |     |
|--|-----|
| Hex keys with handle<br>Klucze imbusowe z rękojęścią.....        | 106 |
| Hex keys & sets<br>Klucze imbusowe i zestawy.....                | 107 |
| Torx Tamperproof keys<br>Klucze imbusowe „Torx Tamperproof”..... | 111 |
| Plastic covered Hex keys<br>Klucze imbusowe powlekane.....       | 111 |

GB Screwdriver CZ Šroubovák  
 D Schraubendreher H Csavarhúzó  
 PL Wkrętkak RO Șurubelniță  
 RUS Отвёртка E Destornillador

PLASTIC HANGER



COLOR BOX



PCS packing:



S2

HRC 58



| YATO    | ⊖ | L (mm) | PCS packing: | 📦      |
|---------|---|--------|--------------|--------|
| YT-2675 | 2 | 75     | 12           | 96/384 |
| YT-2760 | 3 | 75     | 12           | 96/384 |
| YT-2761 | 3 | 100    | 12           | 96/384 |
| YT-2715 | 3 | 150    | 12           | 60/240 |
| YT-2716 | 3 | 200    | 12           | 60/240 |
| YT-2676 | 4 | 100    | 12           | 96/384 |
| YT-2677 | 4 | 150    | 12           | 96/384 |
| YT-2678 | 4 | 200    | 12           | 96/384 |
| YT-2679 | 5 | 38     | 12           | 60/240 |

| YATO    | ⊖ | L (mm) | PCS packing: | 📦      |
|---------|---|--------|--------------|--------|
| YT-2762 | 5 | 75     | 12           | 60/240 |
| YT-2763 | 5 | 100    | 12           | 60/240 |
| YT-2764 | 5 | 150    | 12           | 60/240 |
| YT-2717 | 5 | 200    | 12           | 36/144 |
| YT-2718 | 5 | 250    | 6            | 36/144 |
| YT-2719 | 5 | 300    | 6            | 24/96  |
| YT-2765 | 6 | 38     | 12           | 60/240 |
| YT-2766 | 6 | 100    | 12           | 36/144 |
| YT-2767 | 6 | 150    | 12           | 36/144 |

| YATO     | ⊖ | L (mm) | PCS packing: | 📦      |
|----------|---|--------|--------------|--------|
| YT-2768  | 6 | 200    | 12           | 36/144 |
| YT-2720  | 6 | 250    | 6            | 36/144 |
| YT-2721  | 6 | 300    | 6            | 24/96  |
| YT-2769  | 8 | 150    | 6            | 24/96  |
| YT-2722  | 8 | 200    | 6            | 24/96  |
| YT-2723  | 8 | 250    | 6            | 24/96  |
| YT-2724* | 8 | 300    | 6            | 24/96  |

\* - product not for european market  
 \* - produkt nieprzeznaczony na rynek europejski



| YATO    | ⊕    | L (mm) | PCS packing: | 📦      |
|---------|------|--------|--------------|--------|
| YT-2682 | PH00 | 65     | 12           | 96/384 |
| YT-2770 | PH0  | 75     | 12           | 96/384 |
| YT-2771 | PH0  | 100    | 12           | 96/384 |
| YT-2725 | PH0  | 150    | 12           | 60/240 |
| YT-2726 | PH0  | 200    | 12           | 60/240 |
| YT-2683 | PH1  | 38     | 12           | 60/240 |
| YT-2772 | PH1  | 75     | 12           | 60/240 |
| YT-2773 | PH1  | 100    | 12           | 60/240 |

| YATO    | ⊕   | L (mm) | PCS packing: | 📦      |
|---------|-----|--------|--------------|--------|
| YT-2774 | PH1 | 150    | 12           | 60/240 |
| YT-2727 | PH1 | 200    | 12           | 36/144 |
| YT-2728 | PH1 | 250    | 6            | 36/144 |
| YT-2729 | PH1 | 300    | 6            | 24/96  |
| YT-2775 | PH2 | 38     | 12           | 60/240 |
| YT-2776 | PH2 | 100    | 12           | 36/144 |
| YT-2777 | PH2 | 150    | 12           | 36/144 |
| YT-2778 | PH2 | 200    | 12           | 36/144 |

| YATO     | ⊕   | L (mm) | PCS packing: | 📦      |
|----------|-----|--------|--------------|--------|
| YT-2730  | PH2 | 250    | 6            | 36/144 |
| YT-2731  | PH2 | 300    | 6            | 24/96  |
| YT-2779  | PH3 | 150    | 6            | 24/96  |
| YT-2732  | PH3 | 200    | 6            | 24/96  |
| YT-2733  | PH3 | 250    | 6            | 24/96  |
| YT-2734* | PH3 | 300    | 6            | 24/96  |

\* - product not for european market  
 \* - produkt nieprzeznaczony na rynek europejski



| YATO    | ⊕   | L (mm) | PCS packing: | 📦      |
|---------|-----|--------|--------------|--------|
| YT-2686 | PZ0 | 75     | 12           | 96/384 |
| YT-2687 | PZ0 | 100    | 12           | 96/384 |
| YT-2688 | PZ1 | 75     | 12           | 60/240 |

| YATO    | ⊕   | L (mm) | PCS packing: | 📦      |
|---------|-----|--------|--------------|--------|
| YT-2689 | PZ1 | 100    | 12           | 60/240 |
| YT-2690 | PZ1 | 200    | 12           | 36/144 |
| YT-2691 | PZ2 | 100    | 12           | 36/144 |

| YATO    | ⊕   | L (mm) | PCS packing: | 📦      |
|---------|-----|--------|--------------|--------|
| YT-2692 | PZ2 | 150    | 12           | 36/144 |
| YT-2693 | PZ2 | 200    | 12           | 36/144 |
| YT-2694 | PZ3 | 150    | 6            | 24/96  |



| YATO    | ⊛  | L (mm) | PCS packing: | 📦      |
|---------|----|--------|--------------|--------|
| YT-2620 | T5 | 75     | 12           | 96/384 |

| YATO    | ⊛  | L (mm) | PCS packing: | 📦      |
|---------|----|--------|--------------|--------|
| YT-2621 | T6 | 75     | 12           | 96/384 |



| YATO    | ⊛   | L (mm) | PCS packing: | 📦      |
|---------|-----|--------|--------------|--------|
| YT-2622 | T7  | 75     | 12           | 96/384 |
| YT-2623 | T8  | 75     | 12           | 96/384 |
| YT-2624 | T9  | 75     | 12           | 96/384 |
| YT-2625 | T10 | 100    | 12           | 60/240 |

| YATO    | ⊛   | L (mm) | PCS packing: | 📦      |
|---------|-----|--------|--------------|--------|
| YT-2626 | T15 | 100    | 12           | 60/240 |
| YT-2627 | T20 | 100    | 12           | 60/240 |
| YT-2628 | T25 | 100    | 12           | 36/144 |
| YT-2629 | T27 | 100    | 12           | 36/144 |

| YATO    | ⊛   | L (mm) | PCS packing: | 📦      |
|---------|-----|--------|--------------|--------|
| YT-2630 | T30 | 100    | 12           | 36/144 |
| YT-2631 | T40 | 100    | 6            | 24/96  |



# Screwdrivers & screwdriver bits Wkrętaki i końcówki wkręta



GB Screwdriver  
D Schraubendreher  
PL Wkrętak  
RUS Отвёртка

CZ Šroubovák  
H Csavarhúzó  
RO Şurubelniţă  
E Destornillador

PLASTIC  
HANGER



COLOR BOX



PCS  
packing:



S2

HRC  
58



- ⊖
- application: for deep seated screws, e. g. in power tool casings
  - przeznaczenie: do wkrętów głęboko osadzonych, np. w obudowach elektronarzędzi
  - cut tip, constant diameter of shaft and tip
  - grot frezowany, stała średnica grotu i końcówki

| YATO    | ⊖ | L (mm) | PCS<br>packing: |        |
|---------|---|--------|-----------------|--------|
| YT-2840 | 5 | 150    | 12              | 60/240 |
| YT-2841 | 5 | 200    | 12              | 36/144 |
| YT-2842 | 5 | 250    | 6               | 36/144 |
| YT-2843 | 5 | 300    | 6               | 24/96  |

| YATO    | ⊖ | L (mm) | PCS<br>packing: |        |
|---------|---|--------|-----------------|--------|
| YT-2844 | 6 | 150    | 12              | 36/144 |
| YT-2845 | 6 | 200    | 12              | 36/144 |
| YT-2846 | 6 | 250    | 6               | 36/144 |
| YT-2847 | 6 | 300    | 6               | 24/96  |

5

GB Go-through screwdriver  
D Schlagschrauber  
PL Wkrętak do pobijania  
RUS Отвёртка-било  
CZ Šroubovák s úderným koncem

H Beütő csavarhúzó  
RO Şurubelniţă pt. fixare  
E Destornillador para dar golpes

PLASTIC  
HANGER



COLOR BOX



6 PCS



CrV  
6150

HRC  
52



| YATO    | ⊖ | L (mm) | PCS<br>packing: |       |
|---------|---|--------|-----------------|-------|
| YT-2699 | 6 | 100    | 6               | 24/96 |
| YT-2700 | 6 | 150    | 6               | 24/96 |
| YT-2701 | 6 | 200    | 6               | 24/96 |
| YT-2702 | 6 | 250    | 6               | 24/96 |

| YATO    | ⊖ | L (mm) | PCS<br>packing: |       |
|---------|---|--------|-----------------|-------|
| YT-2703 | 8 | 150    | 6               | 24/72 |
| YT-2704 | 8 | 200    | 6               | 24/72 |
| YT-2705 | 8 | 250    | 6               | 24/72 |
| YT-2706 | 8 | 300    | 6               | 24/72 |



| YATO    | ⊕   | L (mm) | PCS<br>packing: |       |
|---------|-----|--------|-----------------|-------|
| YT-2708 | PH2 | 100    | 6               | 24/96 |
| YT-2709 | PH2 | 150    | 6               | 24/96 |
| YT-2710 | PH3 | 150    | 6               | 24/72 |

| YATO    | ⊖   | L (mm) | PCS<br>packing: |       |
|---------|-----|--------|-----------------|-------|
| YT-2711 | PH3 | 200    | 6               | 24/72 |
| YT-2712 | PH3 | 250    | 6               | 24/72 |

GB Screwdriver set  
D Schraubendrehersatz  
PL Komplet wkręta

RUS Набор отвёрток  
CZ Zámečnické šroubováky  
H Lakatos csavarhúzó

RO Şurubelniţe de lăcătuşerie  
E Juego de destornilladores

2  
PCS



CrV  
6150

HRC  
52



DOUBLE  
BLISTER



| YATO    | ⊖ | ⊕   | L (mm) |      |
|---------|---|-----|--------|------|
| YT-1600 | 6 |     | 150    | 6/36 |
|         |   | PH2 | 150    |      |

GB Screwdriver set  
 D Schraubendrehersatz  
 PL Komplet wkręteków  
 RUS Набор отвёрток

CZ Zámečnické šroubováky  
 H Lakatos csavarhózó  
 RO Șurubelnițe de lăcătușerie  
 E Juego de destornilladores

DOUBLE  
 BLISTER



6  
 PCS



| YATO    | ⊖ | ⊕   | L (mm) |      |
|---------|---|-----|--------|------|
| YT-2783 | 3 |     | 75     | 6/24 |
|         | 5 |     | 100    |      |
|         | 6 |     | 100    |      |
|         |   | PH0 | 75     |      |
|         |   | PH1 | 100    |      |
|         |   | PH2 | 100    |      |

8  
 PCS



| YATO    | ⊖   | ⊕   | L (mm) |      |
|---------|-----|-----|--------|------|
| YT-2782 | 2.0 |     | 50     | 6/24 |
|         | 2.4 |     | 50     |      |
|         | 6.0 |     | 38     |      |
|         | 6.0 |     | 100    |      |
|         |     | PH0 | 50     |      |
|         |     | PH1 | 50     |      |
|         |     | PH2 | 38     |      |
|         |     | PH2 | 100    |      |

8  
 PCS



| YATO    | ⊖ | ⊕   | L (mm) |      |
|---------|---|-----|--------|------|
| YT-2784 | 5 |     | 100    | 6/12 |
|         | 6 |     | 100    |      |
|         | 8 |     | 150    |      |
|         |   | PH0 | 75     |      |
|         |   | PH1 | 100    |      |
|         |   | PH2 | 38     |      |
|         |   | PH2 | 100    |      |
|         |   | PH3 | 150    |      |

12  
 PCS



| YATO    | ⊖ | ⊕   | ⊗   | L (mm) |      |
|---------|---|-----|-----|--------|------|
| YT-2787 | 3 |     |     | 75     | 6/12 |
|         | 5 |     |     | 75     |      |
|         | 6 |     |     | 38     |      |
|         | 6 |     |     | 150    |      |
|         | 8 |     |     | 150    |      |
|         |   | PH0 |     | 75     |      |
|         |   | PH1 |     | 75     |      |
|         |   | PH2 |     | 38     |      |
|         |   | PH2 |     | 100    |      |
|         |   | PH3 |     | 150    |      |
|         |   |     | SO1 | 100    |      |
|         |   |     | SO2 | 100    |      |

15  
 PCS



| YATO    | ⊖   | ⊕    | ⊗  | L (mm) |      |
|---------|-----|------|----|--------|------|
| YT-2788 | 1.5 |      |    | 50     | 6/24 |
|         | 2.0 |      |    | 50     |      |
|         | 5.0 |      |    | 75     |      |
|         | 6.0 |      |    | 38     |      |
|         | 6.0 |      |    | 100    |      |
|         | 6.0 |      |    | 125    |      |
|         |     | PH00 |    | 50     |      |
|         |     | PH0  |    | 50     |      |
|         |     | PH1  |    | 75     |      |
|         |     | PH2  |    | 38     |      |
|         |     | PH2  |    | 100    |      |
|         |     |      | T5 | 50     |      |
|         |     |      | T6 | 50     |      |
|         |     |      | T7 | 50     |      |
|         |     |      | T8 | 50     |      |

# Screwdrivers & screwdriver bits

## Wkrętaki i końcówki wkrętakowe



GB 6 in 1 interchangeable screwdriver set  
 D Umsteckschraubendreher  
 PL Wkrętak z końcówkami dwustronnymi  
 RUS Отвёртка с двухсторонними насадками  
 CZ Šroubovák lances  
 z dvoustrannou koncovkou  
 H Csavarhúzó kétvégű szárral  
 RO Şurubelniţă cu dublu capăt  
 E Destornillador con punta  
 de dos caras



DOUBLE  
BLISTER



|             |       |
|-------------|-------|
| <b>YATO</b> |       |
| YT-2781     | 12/96 |

GB Screwdriver set  
 D Schraubendrehersatz  
 PL Komplet wkrętaków  
 RUS Набор отвёрток  
 CZ Zámečnické šroubováky  
 H Lakatos csavarhúzó  
 RO Şurubelniţe de lăcătuşerie  
 E Juego de destornilladores



PLASTIC HANGER  
& DOUBLE BLISTER

DOUBLE  
BLISTER

9  
PCS



PLASTIC  
HANGER



18  
PCS



27  
PCS



| YATO    | ⊖ | ⊕   | L (mm) |      |
|---------|---|-----|--------|------|
| YT-2785 | 3 |     | 75     | 6/12 |
|         | 5 |     | 75     |      |
|         | 6 |     | 100    |      |
|         | 6 |     | 150    |      |
|         | 8 |     | 150    |      |
|         |   | PH0 | 75     |      |
|         |   | PH1 | 75     |      |
|         |   | PH2 | 100    |      |
|         |   | PH2 | 150    |      |

| YATO    | ⊖   | ⊕    | ⊗  | L (mm) |      |
|---------|-----|------|----|--------|------|
| YT-2786 | 2.4 |      |    | 50     | 6/12 |
|         | 3.0 |      |    | 50     |      |
|         | 5.0 |      |    | 75     |      |
|         | 6.0 |      |    | 38     |      |
|         | 6.0 |      |    | 100    |      |
|         | 8.0 |      |    | 150    |      |
|         |     | PH00 |    | 50     |      |
|         |     | PH0  |    | 50     |      |
|         |     | PH1  |    | 75     |      |
|         |     | PH2  |    | 38     |      |
|         |     | PH2  |    | 100    |      |
|         |     | PH3  |    | 150    |      |
|         |     |      | T5 | 50     |      |
|         |     |      | T6 | 50     |      |
|         |     |      | T7 | 50     |      |
|         |     |      | T8 | 50     |      |
|         |     | T9   | 50 |        |      |
|         |     | T10  | 50 |        |      |

| YATO    | ⊖   | ⊕    | L (mm) |      |
|---------|-----|------|--------|------|
| YT-2789 | 2.0 |      | 50     | 5/25 |
|         | 2.4 |      | 50     |      |
|         | 3.0 |      | 75     |      |
|         | 5.0 |      | 75     |      |
|         | 6.0 |      | 38     |      |
|         | 6.0 |      | 100    |      |
|         | 8.0 |      | 150    |      |
|         |     | PH00 | 50     |      |
|         |     | PH0  | 50     |      |
|         |     | PH0  | 75     |      |
|         |     | PH1  | 75     |      |
|         |     | PH2  | 38     |      |
|         |     | PH2  | 100    |      |
|         |     | PH3  | 150    |      |

GB Mini pick & hook set  
 D Mini hacken set  
 PL Zestaw haczyków z rękojeścią  
 RUS Набор ключков с рукоятками  
 CZ Sada háčkových mini páčidel  
 H Mini ár és kampó készlet  
 RO Mini-set pt. extras garnituri  
 E Juego de palancas de hierro



SLIDING  
CARD



|             |       |
|-------------|-------|
| <b>YATO</b> |       |
| YT-0843     | 12/72 |

GB Precision screwdriver set  
 D Präzisions-Feinmechanikersatz  
 PL Zestaw wkrętek precyzyjnych  
 RUS Набор прецизионных отвёрток  
 CZ Šroubová sada pro jemnou mechaniku  
 H Órás csavarhúzó készlet  
 RO Set surubelnite  
 E Destornilladores precisos



PLASTIC BOX & DOUBLE BLISTER



S2

6 PCS  
 ⊖  
 ⊕  
 HRC 58

6 PCS  
 ⊕  
 HRC 58

| YATO    | ⊖   | ⊕    | L (mm) |       |
|---------|-----|------|--------|-------|
| YT-2790 | 1.4 |      | 50     | 15/60 |
|         | 2.0 |      | 50     |       |
|         | 2.4 |      | 50     |       |
|         |     | PH00 | 50     |       |
|         |     | PH0  | 50     |       |
|         |     | PH1  | 50     |       |

| YATO    | ⊕   | L (mm) |       |
|---------|-----|--------|-------|
| YT-2791 | T5  | 50     | 15/60 |
|         | T6  | 50     |       |
|         | T7  | 50     |       |
|         | T8  | 50     |       |
|         | T9  | 50     |       |
|         | T10 | 50     |       |



6 PCS  
 ⊕

7 PCS  
 ⊖  
 ⊕  
 ⊕  
 HRC 58

7 PCS  
 ⊖  
 ⊕  
 ⊕

| YATO    | ⊕   | L (mm) |      |
|---------|-----|--------|------|
| YT-2576 | T5  | 40     | 6/36 |
|         | T6  | 40     |      |
|         | T7  | 40     |      |
|         | T8  | 40     |      |
|         | T9  | 40     |      |
|         | T10 | 40     |      |

| YATO    | ⊖   | ⊕    | ⊕  | L (mm) |      |
|---------|-----|------|----|--------|------|
| YT-2795 | 2.4 |      |    | 40     | 6/36 |
|         | 3.0 |      |    | 40     |      |
|         |     | PH00 |    | 40     |      |
|         |     | PH0  |    | 40     |      |
|         |     |      | T6 | 40     |      |
|         |     |      | T7 | 40     |      |
|         |     |      | T8 | 40     |      |

| YATO    | ⊖   | ⊕    | ⊕   | L (mm) |      |
|---------|-----|------|-----|--------|------|
| YT-2577 | 2.4 |      |     | 40     | 6/36 |
|         | 3.0 |      |     | 40     |      |
|         |     | PH00 |     | 40     |      |
|         |     | PH0  |     | 40     |      |
|         |     |      | T8  | 40     |      |
|         |     |      | T9  | 40     |      |
|         |     |      | T10 | 40     |      |

GB Long precision screwdriver set  
 D Präzisions-Feinmechanikersatz  
 PL Zestaw wkrętek precyzyjnych długich  
 RUS Набор прецизионных отвёрток  
 CZ Šroubová sada pro jemnou mechaniku  
 H Órás csavarhúzó készlet  
 RO Set surubelnite  
 E Destornilladores precisos



6 PCS  
 S2  
 ⊖  
 ⊕

SLIDING CARD



| YATO    | ⊖   | ⊕    | L (mm) |        |
|---------|-----|------|--------|--------|
| YT-2575 | 2.5 |      | 150    | 12/120 |
|         | 3.0 |      | 150    |        |
|         | 3.5 |      | 150    |        |
|         |     | PH00 | 150    |        |
|         |     | PH0  | 150    |        |
|         |     | PH1  | 150    |        |

# Screwdrivers & screwdriver bits

## Wkrętaki i końcówki wkrętakowe



GB Screwdriver CZ Šroubovák  
 D Schraubendreher H Csavarhúzó  
 PL Wkrętak RO Șurubelniță  
 RUS Отвёртка E Destornillador

COLOR BOX



SVCM55



- application: industry
- can be used as go-through
- special highest quality alloy steel
- przeznaczenie: przemysł
- możliwość pobijania
- stal wysokostopowa



⊖ HRC 58-62

⊖ HRC 55-59

| YATO    | ⊖   | L (mm) | PCS packing | ☐   |
|---------|-----|--------|-------------|-----|
| YT-2601 | 3.0 | 75     | 12          | 240 |
| YT-2606 | 4.0 | 100    | 12          | 240 |
| YT-2608 | 5.5 | 100    | 12          | 240 |
| YT-2609 | 5.5 | 150    | 12          | 240 |
| YT-2610 | 5.5 | 200    | 12          | 240 |
| YT-2612 | 6.5 | 38     | 12          | 240 |
| YT-2613 | 6.5 | 100    | 12          | 240 |
| YT-2614 | 6.5 | 150    | 12          | 240 |
| YT-2615 | 6.5 | 200    | 12          | 240 |
| YT-2618 | 8.0 | 150    | 6           | 120 |

| YATO    | ⊖   | L (mm) | PCS packing | ☐   |
|---------|-----|--------|-------------|-----|
| YT-2602 | 3.0 | 100    | 12          | 240 |
| YT-2633 | 3.0 | 300    | 12          | 240 |
| YT-2603 | 4.0 | 38     | 12          | 240 |
| YT-2604 | 4.0 | 75     | 12          | 240 |
| YT-2607 | 4.0 | 150    | 12          | 240 |
| YT-2634 | 4.0 | 400    | 12          | 240 |
| YT-2635 | 5.0 | 300    | 12          | 120 |
| YT-2636 | 5.0 | 400    | 12          | 120 |
| YT-2619 | 8.0 | 200    | 6           | 120 |

- application: industry
- can be used as go-through
- special highest quality alloy steel
- przeznaczenie: przemysł
- możliwość pobijania
- stal wysokostopowa



⊕ HRC 58-62

⊕ HRC 55-59

| YATO    | ⊕   | L (mm) | PCS packing | ☐   |
|---------|-----|--------|-------------|-----|
| YT-2640 | PH0 | 75     | 12          | 240 |
| YT-2642 | PH1 | 75     | 12          | 240 |
| YT-2643 | PH1 | 100    | 12          | 240 |
| YT-2644 | PH1 | 150    | 12          | 240 |
| YT-2645 | PH1 | 200    | 12          | 240 |
| YT-2647 | PH2 | 38     | 12          | 240 |
| YT-2648 | PH2 | 100    | 12          | 240 |
| YT-2649 | PH2 | 150    | 12          | 240 |
| YT-2650 | PH2 | 200    | 12          | 240 |
| YT-2651 | PH2 | 250    | 12          | 240 |
| YT-2653 | PH3 | 150    | 6           | 120 |

| YATO    | ⊕   | L (mm) | PCS packing | ☐   |
|---------|-----|--------|-------------|-----|
| YT-2637 | PH0 | 300    | 12          | 240 |
| YT-2641 | PH1 | 38     | 12          | 240 |
| YT-2638 | PH1 | 400    | 12          | 120 |
| YT-2639 | PH2 | 400    | 12          | 120 |

- application: industry
- can be used as go-through
- special highest quality alloy steel
- przeznaczenie: przemysł
- możliwość pobijania
- stal wysokostopowa



⊕ HRC 58-62

⊕ HRC 55-59

| YATO    | ⊕   | L (mm) | PCS packing | ☐   |
|---------|-----|--------|-------------|-----|
| YT-2661 | PZ0 | 75     | 12          | 240 |
| YT-2663 | PZ1 | 100    | 12          | 240 |
| YT-2665 | PZ2 | 150    | 12          | 240 |
| YT-2667 | PZ3 | 150    | 6           | 240 |

| YATO    | ⊕   | L (mm) | PCS packing | ☐   |
|---------|-----|--------|-------------|-----|
| YT-2656 | PZ0 | 300    | 12          | 240 |
| YT-2654 | PZ1 | 38     | 12          | 240 |
| YT-2657 | PZ1 | 400    | 12          | 120 |
| YT-2655 | PZ2 | 38     | 12          | 240 |
| YT-2658 | PZ2 | 400    | 12          | 120 |

- application: industry
- can be used as go-through
- special highest quality alloy steel
- przeznaczenie: przemysł
- możliwość pobijania
- stal wysokostopowa



⊗ HRC 58-62

⊗ HRC 58-62

⊗ HRC 55-59

| YATO    | ⊗  | L (mm) | PCS packing | ☐   |
|---------|----|--------|-------------|-----|
| YT-2741 | T5 | 75     | 12          | 240 |
| YT-2742 | T6 | 75     | 12          | 240 |

| YATO    | ⊗   | L (mm) | PCS packing | ☐   |
|---------|-----|--------|-------------|-----|
| YT-2743 | T7  | 75     | 12          | 240 |
| YT-2744 | T8  | 75     | 12          | 240 |
| YT-2745 | T9  | 75     | 12          | 240 |
| YT-2746 | T10 | 100    | 12          | 240 |
| YT-2748 | T15 | 100    | 12          | 240 |
| YT-2750 | T20 | 100    | 12          | 240 |
| YT-2752 | T25 | 100    | 12          | 240 |
| YT-2753 | T27 | 100    | 12          | 240 |
| YT-2754 | T30 | 100    | 12          | 240 |
| YT-2756 | T40 | 100    | 12          | 240 |

| YATO    | ⊗   | L (mm) | PCS packing | ☐   |
|---------|-----|--------|-------------|-----|
| YT-2757 | T45 | 100    | 12          | 240 |

5

GB Screwdriver set  
 D Schraubendrehersatz  
 PL Komplet wkręteków  
 RUS Набор отвёрток

CZ Zámečnické šroubováky  
 H Lakatos csavarhózó  
 RO Șurubelnițe de lăcătușerie  
 E Juego de destornilladores

DOUBLE  
 BLISTER



SVC55

HRC 58-62



6 PCS  

| YATO    | ⊖   | ⊕   | L (mm) |  |
|---------|-----|-----|--------|---|
| YT-2668 | 5.5 |     | 100    | 6/24  |
|         | 6.5 |     | 100    |   |
|         | 8.0 |     | 150    |   |
|         |     | PH1 | 100    |   |
|         |     | PH2 | 100    |   |
|         |     | PH3 | 150    |   |



7 PCS   

| YATO    | ⊖   | ⊕   | ⊕   | L (mm) |  |
|---------|-----|-----|-----|--------|---|
| YT-2669 | 5.5 |     |     | 100    | 4/16  |
|         | 6.5 |     |     | 38     |   |
|         | 6.5 |     |     | 150    |   |
|         |     | PH1 |     | 100    |   |
|         |     | PH2 |     | 150    |   |
|         |     |     | PZ1 | 100    |   |
|         |     | PZ2 | 150 |        |   |



8 PCS  

| YATO    | ⊖   | ⊕   | L (mm) |  |
|---------|-----|-----|--------|---|
| YT-2670 | 4.0 |     | 100    | 4/16  |
|         | 5.5 |     | 100    |   |
|         | 6.5 |     | 38     |   |
|         | 6.5 |     | 100    |   |
|         |     | PH0 | 75     |   |
|         |     | PH1 | 100    |   |
|         |     | PH2 | 38     |   |
|         |     | PH2 | 100    |   |

# Screwdrivers & screwdriver bits

## Wkrętaki i końcówki wkrętakowe



GB Precision screwdriver  
D Präzisions-Schraubendreher  
PL Wkrętak precyzyjny

RUS Отвёртка для точных работ  
CZ Šroubovák pro jemnou mechaniku  
H Műszerész csavarhúzó

RO Șurubelniță mecanica fina  
E Destornillador de precisión

S2

HRC  
57-61



| YATO     | ⊖   | L (mm) | ☐      |
|----------|-----|--------|--------|
| YT-25802 | 1.4 | 50     | 50/400 |
| YT-25803 | 1.6 | 50     | 50/400 |
| YT-25804 | 1.8 | 50     | 50/400 |
| YT-25805 | 2.0 | 50     | 50/400 |
| YT-25806 | 2.0 | 75     | 50/400 |
| YT-25807 | 2.4 | 50     | 50/400 |
| YT-25808 | 2.4 | 75     | 50/400 |
| YT-25809 | 3.0 | 50     | 50/400 |
| YT-25810 | 3.0 | 75     | 50/400 |
| YT-25811 | 3.0 | 100    | 50/400 |

| YATO     | ⊕     | L (mm) | ☐      |
|----------|-------|--------|--------|
| YT-25831 | PH000 | 50     | 50/400 |
| YT-25832 | PH000 | 75     | 50/400 |
| YT-25833 | PH00  | 50     | 50/400 |
| YT-25834 | PH00  | 75     | 50/400 |
| YT-25835 | PH0   | 50     | 50/400 |
| YT-25836 | PH0   | 75     | 50/400 |
| YT-25837 | PH0   | 100    | 50/400 |
| YT-25838 | PH1   | 50     | 50/400 |
| YT-25839 | PH1   | 100    | 50/400 |
| YT-25840 | PH1   | 150    | 50/400 |



| YATO     | ⊕   | L (mm) | ☐      |
|----------|-----|--------|--------|
| YT-25841 | PZ0 | 50     | 50/400 |
| YT-25842 | PZ0 | 75     | 50/400 |
| YT-25843 | PZ0 | 100    | 50/400 |
| YT-25844 | PZ1 | 50     | 50/400 |
| YT-25845 | PZ1 | 100    | 50/400 |
| YT-25846 | PZ1 | 150    | 50/400 |

| YATO     | ⊗   | L (mm) | ☐      |
|----------|-----|--------|--------|
| YT-25852 | T5  | 50     | 50/400 |
| YT-25853 | T6  | 50     | 50/400 |
| YT-25854 | T7  | 50     | 50/400 |
| YT-25855 | T8  | 50     | 50/400 |
| YT-25856 | T9  | 50     | 50/400 |
| YT-25857 | T10 | 50     | 50/400 |

GB Precision screwdriver set  
D Präzisions-Feinmechanikersatz  
PL Zestaw wkrętaków precyzyjnych  
RUS Набор прецизионных отвёрток

CZ Šroubováky sada pro jemnou mechaniku  
H Órás csavarhúzó készlet  
RO Set șurubelnițe  
E Destornilladores precisos

PLASTIC BOX  
& DOUBLE  
BLISTER

S2

HRC  
57-61



6  
PCS



6  
PCS



| YATO     | ⊖   | ⊕    | L (mm) | ☐    |
|----------|-----|------|--------|------|
| YT-25861 | 1.4 |      | 50     | 6/36 |
|          | 2.0 |      | 50     |      |
|          | 2.4 |      | 50     |      |
|          |     | PH00 | 50     |      |
|          |     | PH0  | 50     |      |
|          |     | PH1  | 50     |      |



| YATO     | ⊗   | L (mm) | ☐    |
|----------|-----|--------|------|
| YT-25862 | T5  | 50     | 6/36 |
|          | T6  | 50     |      |
|          | T7  | 50     |      |
|          | T8  | 50     |      |
|          | T9  | 50     |      |
|          | T10 | 50     |      |

7  
PCS



| YATO     | ⊖   | ⊕    | ⊗  | L (mm) | ☐    |
|----------|-----|------|----|--------|------|
| YT-25863 | 2.0 |      |    | 50     | 6/36 |
|          | 3.0 |      |    | 50     |      |
|          |     | PH00 |    | 50     |      |
|          |     | PH0  |    | 50     |      |
|          |     |      | T5 | 50     |      |
|          |     |      | T6 | 50     |      |
|          |     |      | T7 | 50     |      |

GB Insulated screwdriver  
 D Isolierte Schraubendreher  
 PL Wkrętak izolowany  
 RUS Изолированная отвёртка

CZ Izolovaný šroubovák  
 H Szigetelt csavarhúzó  
 RO Șurubelniță izolată  
 E Destornillador aislado

PLASTIC  
 HANGER



1000 V S2 HRC 56-60



• application: industry • przeznaczenie: przemysł  
 • VDE certificate • certyfikat VDE

| YATO    | ⊖   | L (mm) | ☐      |
|---------|-----|--------|--------|
| YT-2815 | 3.0 | 75     | 12/120 |
| YT-2816 | 4.0 | 75     | 12/120 |
| YT-2817 | 4.0 | 100    | 12/120 |

| YATO    | ⊖   | L (mm) | ☐      |
|---------|-----|--------|--------|
| YT-2818 | 5.5 | 125    | 12/120 |
| YT-2819 | 6.5 | 150    | 12/120 |
| YT-2820 | 8.0 | 175    | 12/120 |

5



• application: industry • przeznaczenie: przemysł  
 • VDE certificate • certyfikat VDE

| YATO    | ⊕   | L (mm) | ☐      |
|---------|-----|--------|--------|
| YT-2821 | PH0 | 60     | 12/120 |
| YT-2822 | PH1 | 80     | 12/120 |

| YATO    | ⊕   | L (mm) | ☐      |
|---------|-----|--------|--------|
| YT-2823 | PH2 | 100    | 12/120 |
| YT-2824 | PH3 | 150    | 12/120 |



• application: industry • przeznaczenie: przemysł  
 • VDE certificate • certyfikat VDE

| YATO    | ⊕   | L (mm) | ☐      |
|---------|-----|--------|--------|
| YT-2825 | PZ1 | 80     | 12/120 |

| YATO    | ⊕   | L (mm) | ☐      |
|---------|-----|--------|--------|
| YT-2826 | PZ2 | 100    | 12/120 |

GB Insulated screwdriver set  
 D Isolierte Schraubendrehersatz  
 PL Komplet wkrętek izolowanych  
 RUS Изолированная отвёртка - набор  
 CZ Izolované šroubováky

H Szigetelt csavarhúzó  
 RO Șurubelniță izolată  
 E Juego de destornilladores aislado

DOUBLE  
 BLISTER



1000 V S2 HRC 56-60



5  
 PCS



7  
 PCS



• application: industry • przeznaczenie: przemysł  
 • VDE certificate • certyfikat VDE

• application: industry • przeznaczenie: przemysł  
 • VDE certificate • certyfikat VDE

| YATO    | ⊖   | ⊕   | L (mm) | ☐     |
|---------|-----|-----|--------|-------|
| YT-2827 | 3.0 |     | 75     | 20/40 |
|         | 4.0 |     | 100    |       |
|         | 5.5 |     | 125    |       |
|         |     | PH1 | 80     |       |
|         |     | PH2 | 100    |       |
|         |     |     |        |       |

| YATO    | ⊖   | ⊕   | ⊕   | L (mm) | ☐     |
|---------|-----|-----|-----|--------|-------|
| YT-2828 | 3.0 |     |     | 75     | 20/40 |
|         | 4.0 |     |     | 100    |       |
|         | 5.5 |     |     | 125    |       |
|         |     | PH1 |     | 80     |       |
|         |     | PH2 |     | 100    |       |
|         |     |     | PZ1 | 80     |       |
|         |     |     | PZ2 | 100    |       |
|         |     |     |     |        |       |
|         |     |     |     |        |       |
|         |     |     |     |        |       |



# Screwdrivers & screwdriver bits

## Wkrętaki i końcówki wkrętakowe



**GB** Ratchet screwdriver set  
**D** Ratschenschraubendreher-Satz mit einsätzen  
**PL** Zestaw wkrętak z grzechotką  
**RUS** Набор головок с трещоткой  
**CZ** Ráčnový kloubový šroubovák s příslušenstvím  
**H** Dugókulcs és bit készlet csukló  
**RO** Set surubelnita  
**E** Juego con destornillador y carraca

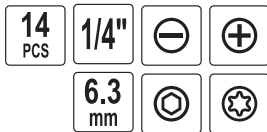

DOUBLE BLISTER

- ▯ 5, 6 mm;
- ⊕ PH1, PH2;
- ⊕ T15, T20;
- 5, 6, 7, 8, 10, 12, 13 mm



**GB** Geared ratcheting speed screwdriver set  
**D** Knarrenschaubendreher mit Drehzahlvervielfältiger  
**PL** Wkrętak z przekładnią i grzechotką  
**RUS** Отвёртка с передачей, трещоткой и вставками  
**CZ** Ráčnový šroubovák se sadou nástavců sada  
**H** Racsnis csavarhúzó készlet  
**RO** Set surubelnita  
**E** Destornillador con engranaje y carraca

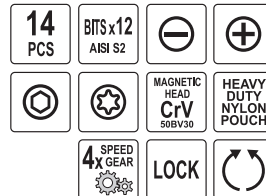

- H2.5, H3, H3.5;
- ⊕ T15, T20, T25;
- ⊕ PH1, PH2, PH3;
- ▯ 5, 6, 7 mm

TIED ON CARD



**GB** 22 in 1 interchangeable screwdriver set  
**D** Umsteckschraubendreher  
**PL** Wkrętak z końcówkami dwustronnymi  
**RUS** Отвёртка - двухсторонние насадки  
**CZ** Šroubovák lancer z dvoustrannou koncovkou  
**H** Csavarhúzó kétfélgű szárral  
**RO** Şurubelnită cu dublu capăt  
**E** Destornillador con punta dos caras

DOUBLE BLISTER

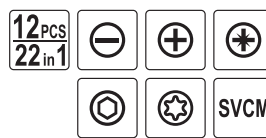

- ▯ 4 mm x 5.5 mm (L=175/115 mm);
- ▯ 6.5 mm x PH3 (L=175/115 mm);
- ⊕ PH1 x PH2 (L=175/115 mm);
- ⊕ PZ1 x PZ2 (L=175/115 mm);
- 3 mm x 3 mm (L=175/115 mm);
- 4 mm x 4 mm (L=175/115 mm);
- 5 mm x 5 mm (L=175/115 mm);
- 6 mm x 6 mm (L=175/115 mm);
- ⊕ T10 x T15 (L=175/115 mm);
- ⊕ T20 x T25 (L=175/115 mm);
- ⊕ T30 x T40 (L=175/115 mm)



**GB** Ratchet screwdriver set  
**D** Ratschenschraubendreher-set mit einsätzen  
**PL** Wkrętak z grzechotką, nasadkami i bitami  
**RUS** Набор головок с трещоткой  
**CZ** Ráčnový kloubový šroubovák s příslušenstvím  
**H** Dugókulcs és bit készlet csukló  
**RO** Set surubelnita  
**E** Juego con destornillador y carraca

DOUBLE BLISTER

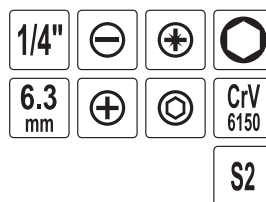

- ▯ 1/4" (6.3 mm): 3.5, 4.0, 5.5, 6.5 mm (L=25 mm);
- ⊕ 1/4" (6.3 mm): PH0, PH1, PH2, PH3 (L=25 mm);
- ⊕ 1/4" (6.3 mm): PZ0, PZ1, PZ2, PZ3 (L=25 mm);
- 1/4" (6.3 mm): 4.0, 5.0, 6.0 mm (L=25 mm);
- 1/4" (6.3 mm): 5, 6(x2), 7(x2), 8, 9(x2), 10(x2), 11, 13 mm; CrV 6150;
- ▯ 1/4" (6.3 mm) x 1/4" (6.3 mm): (L=30 mm)



- ▯ 1/4" (6.3 mm): 3.5, 4.0, 5.5, 6.5 mm (L=25 mm);
- ⊕ 1/4" (6.3 mm): PH0, PH1, PH2, PH3 (L=25 mm);
- ⊕ 1/4" (6.3 mm): PZ0, PZ1, PZ2, PZ3 (L=25 mm);
- 1/4" (6.3 mm): 4.0, 5.0, 6.0 mm (L=25 mm);
- 1/4" (6.3 mm): 5, 6(x2), 7(x2), 8, 9(x2), 10(x2), 11, 13 mm; CrV 6150;
- ▯ 1/4" (6.3 mm) x 1/4" (6.3 mm): (L=30 mm); ▯ 1/4" (6.3 mm): (L=30 mm)



**GB** Ratchet screwdriver set  
**D** Ratschenschraubendreher-Satz mit einsetzen  
**PL** Wkrętak z grzechotką, przegubem i bitami  
**RUS** Набор головок с трещоткой

**CZ** Ráčnový kloubový šroubovák s příslušenstvím  
**H** Dugókulcs és bit készlet csuklós  
**RO** Set surubelnita  
**E** Juego con destornillador y carraca

BMC WITH WINDOW & COLOR BOX



1/4" 6.3 mm  
 CrV 6150  
 S2



50 PCS METRIC & S.A.E.

- 1/4" (6.3 mm): 2.0, 3.0, 3.5, 4.0, 4.5, 5.5, 6.5 mm (L=25 mm); S2;
- 1/4" (6.3 mm): PH0, PH1, PH2, PH3 (L=25 mm); S2;
- 1/4" (6.3 mm): PZ0, PZ1, PZ2, PZ3 (L=25 mm); S2;
- 1/4" (6.3 mm): T10, T15, T20, T25, T27, T30 (L=25 mm); S2;
- 1/4" (6.3 mm): 2.0, 3.0, 4.0, 5.0, 6.0 mm (L=25 mm); S2;
- 1/4" (6.3 mm): SQ0, SQ1, SQ2, SQ3 (L=25 mm); S2;
- 1/4" (6.3 mm): 5, 6, 7, 8, 9, 10, 11, 12, 13 mm; CrV 6150;
- 1/4" (6.3 mm): 1/4" (6.3 mm) x 3/16" (4.8 mm), 1/4" (6.3 mm) x 7/32" (5.6 mm), 1/4" (6.3 mm) x 1/4" (6.3 mm), 1/4" (6.3 mm) x 5/16" (7.9 mm), 1/4" (6.3 mm) x 11/32" (8.7 mm), 1/4" (6.3 mm) x 3/8" (9.5 mm), 1/4" (6.3 mm) x 7/16" (11.1 mm), 1/4" (6.3 mm) x 15/32" (11.9 mm), 1/4" (6.3 mm) x 1/2" (12.7 mm); CrV 6150;
- 1/4" (6.3 mm); (L=150 mm)

YATO YT-2799 6/24



75 PCS

- 1/4" (6.3 mm): 2.0(x2), 3.0(x2), 3.5(x2), 4.0(x2), 4.5(x2), 5.0(x2), 5.5(x2), 6.5(x2) mm (L=25 mm); S2;
- 1/4" (6.3 mm): PH0(x2), PH1(x2), PH2(x2), PH3(x2) (L=25 mm); S2;
- 1/4" (6.3 mm): PZ0(x3), PZ1(x3), PZ2(x2), PZ3(x2) (L=25 mm); S2;
- 1/4" (6.3 mm): T10(x3), T15(x3), T20(x3), T25(x3), T27(x2), T30(x2) (L=25 mm); S2;
- 1/4" (6.3 mm): 2.0, 3.0, 4.0, 5.0, 6.0 mm (L=25 mm); S2;
- 1/4" (6.3 mm): SQ0(x2), SQ1(x2), SQ2(x2), SQ3(x2) (L=25 mm); S2;
- 1/4" (6.3 mm): 5, 6, 7, 8, 9, 10, 11, 12, 13 mm; CrV 6150;
- 1/4" (6.3 mm); (L=60 mm); CrV 6150/S2

YATO YT-2571 6/24

**GB** Precision screwdriver with bits  
**D** Schraubendreher und bit-satz  
**PL** Wkrętak elastyczny z wymiennymi bitami

**RUS** Отвёртка с прецизионными битами  
**CZ** Šroubovák ráčnový se sadou bitů  
**H** Órás csavarhúzó-bit készlet

**RO** Surubelnita + set biti  
**E** Juego de piezas terminales para destornillador + mango

DOUBLE BLISTER



31 PCS 1/4" 6.3 mm  
 S2  
 CrV 6150

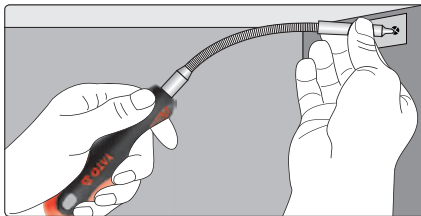

- 215 mm:  
 1/4" (6.3 mm): 3.0, 3.5, 4.0, 5.5, 6.5 mm (L=25 mm);  
 1/4" (6.3 mm): PH0, PH1, PH2, PH3 (L=25 mm);  
 1/4" (6.3 mm): PZ0, PZ1, PZ2, PZ3 (L=25 mm);  
 1/4" (6.3 mm): T10, T15 (L=25 mm);  
 1/4" (6.3 mm): 2.0, 3.0, 4.0, 5.0, 6.0 mm (L=25 mm);  
 1/4" (6.3 mm): 5.0, 6.0, 7.0, 8.0(x2), 9.0, 10.0, 11.0, 12.0, 13.0 mm

YATO YT-2780 6/24

**GB** Ratchet screwdriver set  
**D** Ratschenschraubendreher-Satz mit einsetzen  
**PL** Zestaw wkrętak z grzechotką  
**RUS** Набор головок с трещоткой

**CZ** Ráčnový kloubový šroubovák s příslušenstvím  
**H** Dugókulcs és bit készlet csuklós  
**RO** Set surubelnita  
**E** Juego con destornillador y carraca

PLASTIC BOX & COLOR BOX



42 PCS 1/4" 6.3 mm  
 CrV 50BV30



- 1/4" (6.3 mm): 5, 6, 7, 8, 9, 10, 11, 12, 13 mm;
- 1/4" (6.3 mm) x 100 mm;
- 1/4" (6.3 mm); CrV 50BV30; H2, H2.5, H3, H4, H5, H6;
- T10, T15, T20, T25, T27, T30, T40; PH1, PH1, PH2, PH2, PH3, PH3;
- 3, 4, 5, 6, 7 mm; PZ1, PZ1, PZ2, PZ2, PZ3, PZ3

YATO YT-2806 12

GB Impact screwdriver  
D Schlagschrauber  
PL Wkrętak udarowy

RUS Отвёртка ударная  
CZ Narazový šroubovák kovový  
H Csavarbehajtó, ütő üzemmóddal

RO Şurubelniţă metalică cu percutor  
E Destornillador de percusión

BITS x6  
CrV 6150



1/2"

12.5 mm  
5/16"

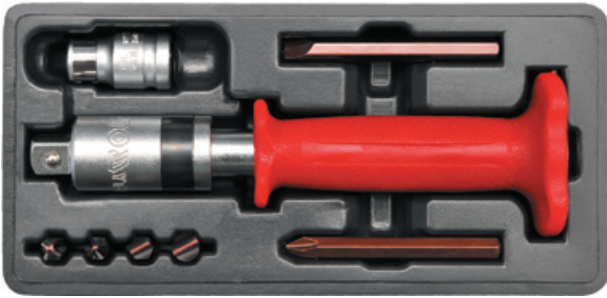

8  
PCS

5/16" (7.9 mm) □ □ □ 1/2" (12.7 mm);  
✦ PH2, PH3 (L=35 mm); PH2 (L=80 mm);  
□ 8, 10 mm (L=35 mm); 8 mm (L=80 mm)



BMC  
& COLOR BOX

|             |    |
|-------------|----|
| <b>YATO</b> |    |
| YT-2800     | 20 |



7  
PCS

5/16" (7.9 mm) □ □ □ 1/2" (12.7 mm);  
✦ PH2, PH3 (L=35 mm); PH2 (L=80 mm);  
□ 8, 10 mm (L=35 mm); 8 mm (L=80 mm)

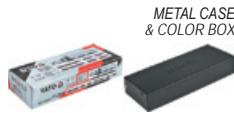

METAL CASE  
& COLOR BOX

|             |      |
|-------------|------|
| <b>YATO</b> |      |
| YT-2801     | 5/20 |



7  
PCS

5/16" (7.9 mm) □ □ □ 1/2" (12.7 mm);  
✦ PH3 (L=35 mm); PH1, PH2, PH3 (L=75 mm);  
□ 8 mm (L=35 mm); 8 mm (L=75 mm)



BMC  
& COLOR BOX

|             |    |
|-------------|----|
| <b>YATO</b> |    |
| YT-2802     | 20 |

GB Screwdriver bit set  
D Schraubendreherbitsatz  
PL Zestaw bitów do wkrętek udarowych  
RUS Набор бит крестовых

CZ Sada bitů  
H Bitkészlet  
RO Truse bit  
E Puntas de destornilladora

CrV  
6150



SLIDING CARD

for / dla: YT-2800, YT-2801

| YATO    | +   | -  | L (mm) | □ (mm)         | PCS packing | □      |
|---------|-----|----|--------|----------------|-------------|--------|
| YT-2810 | PH2 |    | 36     | 5/16" (7.9 mm) | 5           | 10/100 |
| YT-2811 | PH3 |    | 36     | 5/16" (7.9 mm) | 5           | 10/100 |
| YT-2812 | PH2 | 8  | 36     | 5/16" (7.9 mm) | 4           | 10/100 |
|         | PH3 | 10 |        |                |             |        |

GB Screwdriver bit  
D Schraubendreherbit  
PL Końcówka śrubokrętowa  
RUS Бит крестовая

CZ Šroubovácová koncovka  
H Csavarhúzóvég  
RO Capăt pt. şurubelniţă  
E Punta de destornilladora

BLISTER CARD

TORX

SAE  
S2



| YATO     | □   | L (mm) | □ (mm) | □      |
|----------|-----|--------|--------|--------|
| YT-0404  | T25 | 30     | 10     | 10/100 |
| YT-0405  | T25 | 75     | 10     | 10/100 |
| YT-04051 | T30 | 30     | 10     | 10/100 |
| YT-04052 | T30 | 75     | 10     | 10/100 |
| YT-0406  | T40 | 30     | 10     | 10/100 |
| YT-0407  | T40 | 75     | 10     | 10/100 |
| YT-0408  | T45 | 30     | 10     | 10/100 |
| YT-0409  | T45 | 75     | 10     | 10/100 |

GB Screwdriver bit  
D Schraubendreherbit  
PL Końcówka śrubokrętowa  
RUS Бит крестовая

CZ Šroubovácová koncovka  
H Csavarhúzóvég  
RO Capăt pt. şurubelniţă  
E Punta de destornilladora



COLD FORGED KUTE NA ZIMNO

218<sub>max.</sub> Nm

SAE  
S2

HRC  
58-62



SLIDING CARD

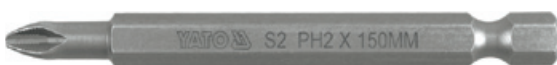

| YATO    | +   | L (mm) | □ (mm)        | □      |
|---------|-----|--------|---------------|--------|
| YT-0485 | PH2 | 100    | 1/4" (6.3 mm) | 25/100 |
| YT-0486 | PH2 | 150    | 1/4" (6.3 mm) | 25/100 |
| YT-0487 | PH2 | 200    | 1/4" (6.3 mm) | 25/100 |

GB Screwdriver bit  
D Schraubendreherbit  
PL Końcówka śrubokrętowa

RUS Бит крестовая  
CZ Šroubovaková koncovka  
H Csavarhúzóvég

RO Capăt pt. șurubelniță  
E Punta de destornilladora

PLASTIC BOX



AISI S2

HRC 58-61

COLD FORGED KUTE NA ZIMNO



| YATO     | +   | L (mm) | torque / moment obrotowy max. (Nm) | PCS packing |
|----------|-----|--------|------------------------------------|-------------|
| YT-04702 | PZ1 | 25     | 6.4                                | 10 25/200   |
| YT-04712 | PZ2 | 25     | 19.6                               | 10 25/200   |
| YT-04722 | PZ3 | 25     | 45.1                               | 10 25/200   |

| YATO     | +   | L (mm) | torque / moment obrotowy max. (Nm) | PCS packing |
|----------|-----|--------|------------------------------------|-------------|
| YT-04742 | PH1 | 25     | 6.4                                | 10 25/200   |
| YT-04752 | PH2 | 25     | 19.6                               | 10 25/200   |
| YT-04762 | PH3 | 25     | 45.1                               | 10 25/200   |

5



| YATO     | +   | L (mm) | torque / moment obrotowy max. (Nm) | PCS packing |
|----------|-----|--------|------------------------------------|-------------|
| YT-04772 | PH1 | 50     | 6.4                                | 10 25/100   |
| YT-04782 | PH2 | 50     | 19.6                               | 10 25/100   |
| YT-04792 | PH3 | 50     | 45.1                               | 10 25/100   |

| YATO     | +   | +   | L (mm) | torque / moment obrotowy max. (Nm) | PCS packing |
|----------|-----|-----|--------|------------------------------------|-------------|
| YT-04812 | PH2 | PH2 | 65     | 19.6 / 19.6                        | 10 25/100   |

GB Screwdriver bit set  
D Schraubendreherbitsatz  
PL Zestaw końcówek śrubokrętowych

CZ Sada bitů  
H Bitkészlet  
RO Truse bit  
E Puntas de destornilladora

PLASTIC BOX



10 PCS

AISI S2

HRC 58-61

COLD FORGED KUTE NA ZIMNO



□ 5, 6 mm; + PH1, PH1, PH2, PH2;  
\* PZ1, PZ1, PZ2, PZ2

□ 5, 6 mm; + PH1, PH1, PH2, PH2;  
\* PZ1, PZ1, PZ2, PZ2

| YATO     | L (mm) | torque / moment obrotowy max. (Nm) | PCS packing |
|----------|--------|------------------------------------|-------------|
| YT-04822 | 25     | 1/4" (6.3 mm)                      | 25/200      |

| YATO     | L (mm) | torque / moment obrotowy max. (Nm) | PCS packing |
|----------|--------|------------------------------------|-------------|
| YT-04832 | 50     | 1/4" (6.3 mm)                      | 25/100      |

GB Screwdriver bit  
D Schraubendreherbit  
PL Końcówka śrubokrętowa

RUS Бит крестовая  
CZ Šroubovaková koncovka  
H Csavarhúzóvég

RO Capăt pt. șurubelniță  
E Punta de destornilladora

PLASTIC BOX



AISI S2

HRC 58-61



| YATO     | +   | L (mm) | torque / moment obrotowy max. (Nm) | PCS packing |
|----------|-----|--------|------------------------------------|-------------|
| YT-78130 | PH0 | 25     | 2.1                                | 10 20/100   |
| YT-78131 | PH1 | 25     | 7.8                                | 10 20/100   |
| YT-78132 | PH2 | 25     | 19.6                               | 10 20/100   |
| YT-78133 | PH3 | 25     | 45.6                               | 10 20/100   |

| YATO     | +   | L (mm) | torque / moment obrotowy max. (Nm) | PCS packing |
|----------|-----|--------|------------------------------------|-------------|
| YT-78134 | PZ1 | 25     | 6.4                                | 10 20/100   |
| YT-78135 | PZ2 | 25     | 19.6                               | 10 20/100   |
| YT-78136 | PZ3 | 25     | 45.1                               | 10 20/100   |



| YATO     | +   | L (mm) | torque / moment obrotowy max. (Nm) | PCS packing |
|----------|-----|--------|------------------------------------|-------------|
| YT-78141 | T10 | 25     | 5.9                                | 10 20/100   |
| YT-78142 | T15 | 25     | 8.4                                | 10 20/100   |
| YT-78143 | T20 | 25     | 14.7                               | 10 20/100   |
| YT-78144 | T25 | 25     | 21.6                               | 10 20/100   |
| YT-78145 | T27 | 25     | 29.4                               | 10 20/100   |
| YT-78146 | T30 | 25     | 45.1                               | 10 20/100   |
| YT-78147 | T40 | 25     | 76.5                               | 10 20/100   |

| YATO     | +   | L (mm) | torque / moment obrotowy max. (Nm) | PCS packing |
|----------|-----|--------|------------------------------------|-------------|
| YT-78150 | PH0 | 50     | 2.1                                | 10 20/100   |
| YT-78151 | PH1 | 50     | 6.4                                | 10 20/100   |
| YT-78152 | PH2 | 50     | 19.6                               | 10 20/100   |
| YT-78153 | PH3 | 50     | 45.1                               | 10 20/100   |

# Screwdrivers & screwdriver bits

## Wkrętaki i końcówki wkrętakowe



GB Screwdriver bit  
D Schraubendreherbit  
PL Końcówka śrubokrętowa

RUS Бит крестовая  
CZ Šroubováková koncovka  
H Csavarhúzóvég

RO Capăt pt. șurubelniță  
E Punta de destornilladora

PLASTIC BOX



AISI S2

HRC 58-61



| YATO     | +   | L (mm) | ⊕             | torque / moment obrotowy max. (Nm) | PCS packing | 📦      |
|----------|-----|--------|---------------|------------------------------------|-------------|--------|
| YT-78154 | PZ1 | 50     | 1/4" (6.3 mm) | 6.4                                | 10          | 20/100 |
| YT-78155 | PZ2 | 50     | 1/4" (6.3 mm) | 19.6                               | 10          | 20/100 |
| YT-78156 | PZ3 | 50     | 1/4" (6.3 mm) | 45.1                               | 10          | 20/100 |

| YATO     | +   | +   | L (mm) | ⊕             | torque / moment obrotowy max. (Nm) | PCS packing | 📦      |
|----------|-----|-----|--------|---------------|------------------------------------|-------------|--------|
| YT-78160 | PH1 | PH1 | 65     | 1/4" (6.3 mm) | 6.4 / 6.4                          | 10          | 20/100 |
| YT-78161 | PH2 | PH2 | 65     | 1/4" (6.3 mm) | 19.6 / 19.6                        | 10          | 20/100 |
| YT-78162 | PH3 | PH3 | 65     | 1/4" (6.3 mm) | 45.1 / 45.1                        | 10          | 20/100 |
| YT-78163 | PH1 | PH2 | 65     | 1/4" (6.3 mm) | 6.4 / 19.6                         | 10          | 20/100 |
| YT-78164 | PH2 | PH3 | 65     | 1/4" (6.3 mm) | 19.6 / 45.1                        | 10          | 20/100 |



| YATO     | +   | ⊖ | L (mm) | ⊕             | torque / moment obrotowy max. (Nm) | PCS packing | 📦      |
|----------|-----|---|--------|---------------|------------------------------------|-------------|--------|
| YT-78165 | PH1 |   | 4.5 65 | 1/4" (6.3 mm) | 6.4 / 6.1                          | 10          | 20/100 |
| YT-78166 | PH2 |   | 5.5 65 | 1/4" (6.3 mm) | 19.6 / 8.8                         | 10          | 20/100 |
| YT-78167 | PH3 |   | 6.5 65 | 1/4" (6.3 mm) | 45.1 / 14.7                        | 10          | 20/100 |

| YATO     | ⊖   | L (mm) | ⊕ (mm) | torque / moment obrotowy max. (Nm) | PCS packing | 📦      |
|----------|-----|--------|--------|------------------------------------|-------------|--------|
| YT-78190 | M5  | 30     | 8      | 20.6                               | 10          | 20/100 |
| YT-78191 | M6  | 30     | 8      | 40.2                               | 10          | 20/100 |
| YT-78192 | M8  | 30     | 8      | 60.8                               | 10          | 20/100 |
| YT-78193 | M10 | 30     | 8      | 156.9                              | 8           | 10/50  |
| YT-78194 | M12 | 30     | 8      | 176.5                              | 6           | 10/50  |

GB Screwdriver bit set  
D Schraubendreherbitsatz  
PL Zestaw końcówek śrubokrętowych

RUS Набор битов  
CZ Sada bitů  
H Bitkészlet

RO Truse bit  
E Puntas de destornilladora



SLIDING CARD



GOLD FORGED KUTE NA ZIMNO

21.8 Nm max.

AISI S2

HRC 58-62



10 PCS



10 PCS



10 PCS



| YATO    | +   | L (mm) | ⊕             | 📦      |
|---------|-----|--------|---------------|--------|
| YT-0470 | PZ1 | 25     | 1/4" (6.3 mm) | 25/200 |
| YT-0471 | PZ2 | 25     | 1/4" (6.3 mm) | 25/200 |
| YT-0472 | PZ3 | 25     | 1/4" (6.3 mm) | 25/200 |

| YATO    | +   | L (mm) | ⊕             | 📦      |
|---------|-----|--------|---------------|--------|
| YT-0477 | PH1 | 50     | 1/4" (6.3 mm) | 25/100 |
| YT-0478 | PH2 | 50     | 1/4" (6.3 mm) | 25/100 |
| YT-0479 | PH3 | 50     | 1/4" (6.3 mm) | 25/100 |
| YT-0480 | PH2 | 75     | 1/4" (6.3 mm) | 25/100 |

| YATO    | +   | L (mm) | ⊕             | 📦      |
|---------|-----|--------|---------------|--------|
| YT-0473 | PH0 | 25     | 1/4" (6.3 mm) | 25/200 |
| YT-0474 | PH1 | 25     | 1/4" (6.3 mm) | 25/200 |
| YT-0475 | PH2 | 25     | 1/4" (6.3 mm) | 25/200 |
| YT-0476 | PH3 | 25     | 1/4" (6.3 mm) | 25/200 |



10 PCS



10 PCS



10 PCS



⊕ 5, 6 mm; ⊕ PH1, PH1, PH2, PH2;  
\* ⊕ PZ1, PZ1, PZ2, PZ2

⊕ 5, 6 mm; ⊕ PH1, PH1, PH2, PH2;  
\* ⊕ PZ1, PZ1, PZ2, PZ2

| YATO    | +   | L (mm) | ⊕             | 📦      |
|---------|-----|--------|---------------|--------|
| YT-0481 | PH2 | 65     | 1/4" (6.3 mm) | 25/100 |

| YATO    | L (mm) | ⊕             | 📦      |
|---------|--------|---------------|--------|
| YT-0482 | 25     | 1/4" (6.3 mm) | 25/200 |

| YATO    | L (mm) | ⊕             | 📦      |
|---------|--------|---------------|--------|
| YT-0483 | 50     | 1/4" (6.3 mm) | 25/100 |

GB Screwdriver bit  
 D Schraubendreherbit  
 PL Końcówka śrubokrętowa

RUS Бит крестовая  
 CZ Šroubovaková koncovka  
 H Csavarhúzóvég

RO Capăt pt. șurubelniță  
 E Punta de destornilladora

COLOR BOX



AISI S2  
 HRC 58-62  
 COLD FORGED KUTE NA ZIMNO



| YATO    | ⊖   | L (mm) | ⊕             | PCS packing | 📦     |
|---------|-----|--------|---------------|-------------|-------|
| YT-7800 | 3.0 | 25     | 1/4" (6.3 mm) | 50          | 20/40 |
| YT-7801 | 4.0 | 25     | 1/4" (6.3 mm) | 50          | 20/40 |
| YT-7802 | 5.0 | 25     | 1/4" (6.3 mm) | 50          | 20/40 |
| YT-7803 | 5.5 | 25     | 1/4" (6.3 mm) | 50          | 20/40 |
| YT-7804 | 6.0 | 25     | 1/4" (6.3 mm) | 50          | 20/40 |
| YT-7805 | 6.5 | 25     | 1/4" (6.3 mm) | 50          | 20/40 |

| YATO    | ⊕   | L (mm) | ⊕             | PCS packing | 📦     |
|---------|-----|--------|---------------|-------------|-------|
| YT-7806 | PH0 | 25     | 1/4" (6.3 mm) | 50          | 20/40 |
| YT-7807 | PH1 | 25     | 1/4" (6.3 mm) | 50          | 20/40 |
| YT-7808 | PH2 | 25     | 1/4" (6.3 mm) | 50          | 20/40 |
| YT-7809 | PH3 | 25     | 1/4" (6.3 mm) | 50          | 20/40 |

| YATO    | ⊕   | L (mm) | ⊕             | PCS packing | 📦     |
|---------|-----|--------|---------------|-------------|-------|
| YT-7810 | PZ1 | 25     | 1/4" (6.3 mm) | 50          | 20/40 |
| YT-7811 | PZ2 | 25     | 1/4" (6.3 mm) | 50          | 20/40 |
| YT-7812 | PZ3 | 25     | 1/4" (6.3 mm) | 50          | 20/40 |

5



| YATO    | ⊕   | L (mm) | ⊕             | PCS packing | 📦     |
|---------|-----|--------|---------------|-------------|-------|
| YT-7813 | T8  | 25     | 1/4" (6.3 mm) | 50          | 20/40 |
| YT-7814 | T10 | 25     | 1/4" (6.3 mm) | 50          | 20/40 |
| YT-7815 | T15 | 25     | 1/4" (6.3 mm) | 50          | 20/40 |
| YT-7816 | T20 | 25     | 1/4" (6.3 mm) | 50          | 20/40 |
| YT-7817 | T25 | 25     | 1/4" (6.3 mm) | 50          | 20/40 |
| YT-7818 | T27 | 25     | 1/4" (6.3 mm) | 50          | 20/40 |
| YT-7819 | T30 | 25     | 1/4" (6.3 mm) | 50          | 20/40 |
| YT-7820 | T40 | 25     | 1/4" (6.3 mm) | 50          | 20/40 |

| YATO    | ⊕   | L (mm) | ⊕             | PCS packing | 📦     |
|---------|-----|--------|---------------|-------------|-------|
| YT-7821 | T8  | 25     | 1/4" (6.3 mm) | 50          | 20/40 |
| YT-7822 | T10 | 25     | 1/4" (6.3 mm) | 50          | 20/40 |
| YT-7823 | T15 | 25     | 1/4" (6.3 mm) | 50          | 20/40 |
| YT-7824 | T20 | 25     | 1/4" (6.3 mm) | 50          | 20/40 |
| YT-7825 | T25 | 25     | 1/4" (6.3 mm) | 50          | 20/40 |
| YT-7826 | T27 | 25     | 1/4" (6.3 mm) | 50          | 20/40 |
| YT-7827 | T30 | 25     | 1/4" (6.3 mm) | 50          | 20/40 |
| YT-7828 | T40 | 25     | 1/4" (6.3 mm) | 50          | 20/40 |

| YATO     | ⊕   | L (mm) | ⊕             | PCS packing | 📦     |
|----------|-----|--------|---------------|-------------|-------|
| YT-7829  | 2.0 | 25     | 1/4" (6.3 mm) | 50          | 20/40 |
| YT-7830  | 2.5 | 25     | 1/4" (6.3 mm) | 50          | 20/40 |
| YT-7831  | 3.0 | 25     | 1/4" (6.3 mm) | 50          | 20/40 |
| YT-7832* | 4.0 | 25     | 1/4" (6.3 mm) | 50          | 20/40 |
| YT-7833  | 5.0 | 25     | 1/4" (6.3 mm) | 50          | 20/40 |
| YT-7834  | 6.0 | 25     | 1/4" (6.3 mm) | 50          | 20/40 |

\* - product not for european market  
 \* - produkt nieprzeznaczony na rynek europejski



| YATO    | ⊖   | L (mm) | ⊕             | PCS packing | 📦     |
|---------|-----|--------|---------------|-------------|-------|
| YT-7840 | 3.0 | 50     | 1/4" (6.3 mm) | 50          | 10/20 |
| YT-7841 | 4.0 | 50     | 1/4" (6.3 mm) | 50          | 10/20 |
| YT-7842 | 5.0 | 50     | 1/4" (6.3 mm) | 50          | 10/20 |
| YT-7843 | 5.5 | 50     | 1/4" (6.3 mm) | 50          | 10/20 |
| YT-7844 | 6.0 | 50     | 1/4" (6.3 mm) | 50          | 10/20 |
| YT-7845 | 6.5 | 50     | 1/4" (6.3 mm) | 50          | 10/20 |

| YATO    | ⊕   | L (mm) | ⊕             | PCS packing | 📦     |
|---------|-----|--------|---------------|-------------|-------|
| YT-7846 | PH0 | 50     | 1/4" (6.3 mm) | 50          | 10/20 |
| YT-7847 | PH1 | 50     | 1/4" (6.3 mm) | 50          | 10/20 |
| YT-7848 | PH2 | 50     | 1/4" (6.3 mm) | 50          | 10/20 |
| YT-7849 | PH3 | 50     | 1/4" (6.3 mm) | 50          | 10/20 |

| YATO    | ⊕   | L (mm) | ⊕             | PCS packing | 📦     |
|---------|-----|--------|---------------|-------------|-------|
| YT-7850 | PZ1 | 50     | 1/4" (6.3 mm) | 50          | 10/20 |
| YT-7851 | PZ2 | 50     | 1/4" (6.3 mm) | 50          | 10/20 |
| YT-7852 | PZ3 | 50     | 1/4" (6.3 mm) | 50          | 10/20 |



\* - product not for european market  
 \* - produkt nieprzeznaczony na rynek europejski

| YATO     | ⊕   | L (mm) | ⊕             | PCS packing | 📦     |
|----------|-----|--------|---------------|-------------|-------|
| YT-7853  | T8  | 50     | 1/4" (6.3 mm) | 50          | 10/20 |
| YT-7854  | T10 | 50     | 1/4" (6.3 mm) | 50          | 10/20 |
| YT-7855  | T15 | 50     | 1/4" (6.3 mm) | 50          | 10/20 |
| YT-7856  | T20 | 50     | 1/4" (6.3 mm) | 50          | 10/20 |
| YT-7857  | T25 | 50     | 1/4" (6.3 mm) | 50          | 10/20 |
| YT-7858  | T27 | 50     | 1/4" (6.3 mm) | 50          | 10/20 |
| YT-7859* | T30 | 50     | 1/4" (6.3 mm) | 50          | 10/20 |
| YT-7860  | T40 | 50     | 1/4" (6.3 mm) | 50          | 10/20 |

| YATO    | ⊕   | L (mm) | ⊕             | PCS packing | 📦     |
|---------|-----|--------|---------------|-------------|-------|
| YT-7861 | T8  | 50     | 1/4" (6.3 mm) | 50          | 10/20 |
| YT-7862 | T10 | 50     | 1/4" (6.3 mm) | 50          | 10/20 |
| YT-7863 | T15 | 50     | 1/4" (6.3 mm) | 50          | 10/20 |
| YT-7864 | T20 | 50     | 1/4" (6.3 mm) | 50          | 10/20 |
| YT-7865 | T25 | 50     | 1/4" (6.3 mm) | 50          | 10/20 |
| YT-7866 | T27 | 50     | 1/4" (6.3 mm) | 50          | 10/20 |
| YT-7867 | T30 | 50     | 1/4" (6.3 mm) | 50          | 10/20 |
| YT-7868 | T40 | 50     | 1/4" (6.3 mm) | 50          | 10/20 |

| YATO    | ⊕   | L (mm) | ⊕             | PCS packing | 📦     |
|---------|-----|--------|---------------|-------------|-------|
| YT-7869 | 2.0 | 50     | 1/4" (6.3 mm) | 50          | 10/20 |
| YT-7870 | 2.5 | 50     | 1/4" (6.3 mm) | 50          | 10/20 |
| YT-7871 | 3.0 | 50     | 1/4" (6.3 mm) | 50          | 10/20 |
| YT-7872 | 4.0 | 50     | 1/4" (6.3 mm) | 50          | 10/20 |
| YT-7873 | 5.0 | 50     | 1/4" (6.3 mm) | 50          | 10/20 |
| YT-7874 | 6.0 | 50     | 1/4" (6.3 mm) | 50          | 10/20 |



| YATO    | ⊕   | ⊕   | L (mm) | ⊕             | PCS packing | 📦     |
|---------|-----|-----|--------|---------------|-------------|-------|
| YT-7880 | PH1 | PH1 | 65     | 1/4" (6.3 mm) | 50          | 10/20 |
| YT-7881 | PH2 | PH2 | 65     | 1/4" (6.3 mm) | 50          | 10/20 |
| YT-7882 | PH3 | PH3 | 65     | 1/4" (6.3 mm) | 50          | 10/20 |
| YT-7883 | PH1 | PH2 | 65     | 1/4" (6.3 mm) | 50          | 10/20 |
| YT-7884 | PH2 | PH3 | 65     | 1/4" (6.3 mm) | 50          | 10/20 |

| YATO    | ⊕   | ⊖   | L (mm) | ⊕             | PCS packing | 📦     |
|---------|-----|-----|--------|---------------|-------------|-------|
| YT-7885 | PH1 | 4.5 | 65     | 1/4" (6.3 mm) | 50          | 10/20 |
| YT-7886 | PH2 | 5.5 | 65     | 1/4" (6.3 mm) | 50          | 10/20 |
| YT-7887 | PH3 | 6.5 | 65     | 1/4" (6.3 mm) | 50          | 10/20 |

| YATO    | ⊕   | ⊕   | L (mm) | ⊕             | PCS packing | 📦     |
|---------|-----|-----|--------|---------------|-------------|-------|
| YT-7888 | PH1 | PH1 | 110    | 1/4" (6.3 mm) | 20          | 10/20 |
| YT-7889 | PH2 | PH2 | 110    | 1/4" (6.3 mm) | 20          | 10/20 |
| YT-7890 | PH3 | PH3 | 110    | 1/4" (6.3 mm) | 20          | 10/20 |

# Screwdrivers & screwdriver bits Wkrętaki i końcówki wkrętakowe

**YATO**

GB Screwdriver bit

D Schraubendreherbit

PL Końcówka śrubokrętowa

RUS Бит крестовая

CZ Šroubovaková koncovka

H Csavarhúzóvég

RO Capăt pt. șurubelniță

E Punta de destornilladora

COLOR BOX



AISI  
S2

HRC  
58-62



| YATO    | ⊖   | L (mm) | ⊘ (mm) | PCS packing |       |
|---------|-----|--------|--------|-------------|-------|
| YT-7891 | 5.5 | 30     | 8      | 50          | 10/20 |
| YT-7892 | 6.5 | 30     | 8      | 50          | 10/20 |
| YT-7893 | 8.0 | 30     | 8      | 50          | 10/20 |



| YATO     | ⊕   | L (mm) | ⊘ (mm) | PCS packing |       |
|----------|-----|--------|--------|-------------|-------|
| YT-7894* | PH1 | 30     | 8      | 50          | 10/20 |
| YT-7895  | PH2 | 30     | 8      | 50          | 10/20 |
| YT-7896* | PH3 | 30     | 8      | 50          | 10/20 |



| YATO     | ⊗   | L (mm) | ⊘ (mm) | PCS packing |       |
|----------|-----|--------|--------|-------------|-------|
| YT-7897  | T10 | 30     | 8      | 50          | 10/20 |
| YT-7898  | T15 | 30     | 8      | 50          | 10/20 |
| YT-7899  | T20 | 30     | 8      | 50          | 10/20 |
| YT-7900  | T25 | 30     | 8      | 50          | 10/20 |
| YT-7901  | T27 | 30     | 8      | 50          | 10/20 |
| YT-7902* | T30 | 30     | 8      | 50          | 10/20 |
| YT-7903  | T40 | 30     | 8      | 50          | 10/20 |
| YT-7904  | T45 | 30     | 8      | 50          | 10/20 |
| YT-7905* | T50 | 30     | 8      | 50          | 10/20 |
| YT-7906  | T55 | 30     | 8      | 20          | 10/40 |
| YT-7907  | T60 | 30     | 8      | 20          | 10/20 |



| YATO     | ⊗   | L (mm) | ⊘ (mm) | PCS packing |       |
|----------|-----|--------|--------|-------------|-------|
| YT-7908* | T10 | 30     | 8      | 50          | 10/20 |
| YT-7909  | T15 | 30     | 8      | 50          | 10/20 |
| YT-7910  | T20 | 30     | 8      | 50          | 10/20 |
| YT-7911  | T25 | 30     | 8      | 50          | 10/20 |
| YT-7912  | T27 | 30     | 8      | 50          | 10/20 |
| YT-7913  | T30 | 30     | 8      | 50          | 10/20 |
| YT-7914  | T40 | 30     | 8      | 50          | 10/20 |
| YT-7915  | T45 | 30     | 8      | 50          | 10/20 |
| YT-7916  | T50 | 30     | 8      | 50          | 10/20 |
| YT-7917  | T55 | 30     | 8      | 20          | 10/40 |
| YT-7918  | T60 | 30     | 8      | 20          | 10/20 |



| YATO    | ⊙   | L (mm) | ⊘ (mm) | PCS packing |       |
|---------|-----|--------|--------|-------------|-------|
| YT-7919 | 4.0 | 30     | 8      | 50          | 10/20 |
| YT-7920 | 5.0 | 30     | 8      | 50          | 10/20 |
| YT-7921 | 6.0 | 30     | 8      | 50          | 10/20 |
| YT-7922 | 7.0 | 30     | 8      | 50          | 10/20 |
| YT-7923 | 8.0 | 30     | 8      | 50          | 10/20 |



| YATO    | ⊙   | L (mm) | ⊘ (mm) | PCS packing |       |
|---------|-----|--------|--------|-------------|-------|
| YT-7929 | M5  | 30     | 8      | 50          | 10/20 |
| YT-7930 | M6  | 30     | 8      | 50          | 10/20 |
| YT-7931 | M8  | 30     | 8      | 50          | 10/20 |
| YT-7932 | M10 | 30     | 8      | 20          | 10/40 |
| YT-7933 | M12 | 30     | 8      | 20          | 10/20 |



| YATO    | ⊖   | L (mm) | ⊘ (mm) | PCS packing |       |
|---------|-----|--------|--------|-------------|-------|
| YT-7934 | 5.5 | 70     | 8      | 20          | 10/20 |
| YT-7935 | 6.5 | 70     | 8      | 20          | 10/20 |
| YT-7936 | 8.0 | 70     | 8      | 20          | 10/20 |



| YATO     | ⊕   | L (mm) | ⊘ (mm) | PCS packing |       |
|----------|-----|--------|--------|-------------|-------|
| YT-7937* | PH1 | 70     | 8      | 20          | 10/20 |
| YT-7938  | PH2 | 70     | 8      | 20          | 10/20 |
| YT-7939  | PH3 | 70     | 8      | 20          | 10/20 |



| YATO    | ⊗   | L (mm) | ⊘ (mm) | PCS packing |       |
|---------|-----|--------|--------|-------------|-------|
| YT-7940 | T10 | 70     | 8      | 20          | 10/20 |
| YT-7941 | T15 | 70     | 8      | 20          | 10/20 |
| YT-7942 | T20 | 70     | 8      | 20          | 10/20 |
| YT-7943 | T25 | 70     | 8      | 20          | 10/20 |
| YT-7944 | T27 | 70     | 8      | 20          | 10/20 |
| YT-7945 | T30 | 70     | 8      | 20          | 10/20 |
| YT-7946 | T40 | 70     | 8      | 20          | 10/20 |
| YT-7947 | T45 | 70     | 8      | 20          | 10/20 |
| YT-7948 | T50 | 70     | 8      | 20          | 10/20 |
| YT-7949 | T55 | 70     | 8      | 20          | 5/10  |
| YT-7950 | T60 | 70     | 8      | 20          | 5/10  |



| YATO    | ⊗   | L (mm) | ⊘ (mm) | PCS packing |       |
|---------|-----|--------|--------|-------------|-------|
| YT-7951 | T10 | 70     | 8      | 20          | 10/20 |
| YT-7952 | T15 | 70     | 8      | 20          | 10/20 |
| YT-7953 | T20 | 70     | 8      | 20          | 10/20 |
| YT-7954 | T25 | 70     | 8      | 20          | 10/20 |
| YT-7955 | T27 | 70     | 8      | 20          | 10/20 |
| YT-7956 | T30 | 70     | 8      | 20          | 10/20 |
| YT-7957 | T40 | 70     | 8      | 20          | 10/20 |
| YT-7958 | T45 | 70     | 8      | 20          | 10/20 |
| YT-7959 | T50 | 70     | 8      | 20          | 10/20 |
| YT-7960 | T55 | 70     | 8      | 20          | 5/10  |
| YT-7961 | T60 | 70     | 8      | 20          | 5/10  |



| YATO    | ⊙   | L (mm) | ⊘ (mm) | PCS packing |       |
|---------|-----|--------|--------|-------------|-------|
| YT-7962 | 4.0 | 70     | 8      | 20          | 10/20 |
| YT-7963 | 5.0 | 70     | 8      | 20          | 10/20 |
| YT-7964 | 6.0 | 70     | 8      | 20          | 10/20 |
| YT-7965 | 7.0 | 70     | 8      | 20          | 10/20 |
| YT-7966 | 8.0 | 70     | 8      | 20          | 10/20 |



| YATO    | ⊙   | L (mm) | ⊘ (mm) | PCS packing |       |
|---------|-----|--------|--------|-------------|-------|
| YT-7971 | M5  | 70     | 8      | 20          | 10/20 |
| YT-7972 | M6  | 70     | 8      | 20          | 10/20 |
| YT-7973 | M8  | 70     | 8      | 20          | 10/20 |
| YT-7974 | M10 | 70     | 8      | 20          | 5/10  |
| YT-7975 | M12 | 70     | 8      | 20          | 5/10  |

GB Screwdriver bit

D Schraubendreherbit

PL Końcówka śrubokrętowa

RUS Бит крестовая

CZ Šroubovaková koncovka

H Csavarhúzóvég

RO Capăt pt. șurubelniță

E Punta de destornilladora



- with limiter
- z ogranicznikiem

COLOR BOX



| YATO    | L (mm) | ⊘ (mm)        | PCS packing |       |
|---------|--------|---------------|-------------|-------|
| YT-7980 | 25     | 1/4* (6.3 mm) | 20          | 20/40 |

GB Screwdriver bit  
 D Schraubendreherbit  
 PL Końcówka śrubokrętu  
 RUS Бит крестовая

CZ Šroubováková koncovka  
 H Csavarhúzóvég  
 RO Capăt pt. șurubelniță  
 E Punta de destornilladora

SLIDING CARD



2 PCS  
 1/4"  
 S2  
 6.3 mm

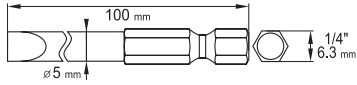
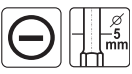

| YATO    | ⊖   | L (mm) | ⬡             | ⊞      |
|---------|-----|--------|---------------|--------|
| YT-0484 | 4.0 | 100    | 1/4" (6.3 mm) | 25/100 |
|         | 5.0 | 100    |               |        |

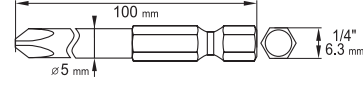
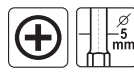

| YATO    | ⊕    | L (mm) | ⬡             | ⊞      |
|---------|------|--------|---------------|--------|
| YT-0459 | PH00 | 100    | 1/4" (6.3 mm) | 25/100 |
|         | PH0  | 100    |               |        |

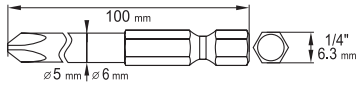
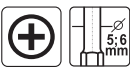

| YATO    | ⊕   | L (mm) | ⬡             | ⊞      |
|---------|-----|--------|---------------|--------|
| YT-0488 | PH1 | 100    | 1/4" (6.3 mm) | 25/100 |
|         | PH2 | 100    |               |        |

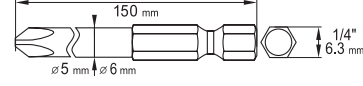
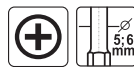

| YATO    | ⊕   | L (mm) | ⬡             | ⊞      |
|---------|-----|--------|---------------|--------|
| YT-0489 | PH1 | 150    | 1/4" (6.3 mm) | 25/100 |
|         | PH2 | 150    |               |        |

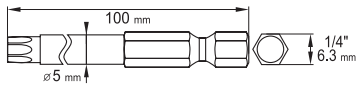
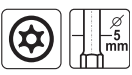

| YATO    | ⊗   | L (mm) | ⬡             | ⊞      |
|---------|-----|--------|---------------|--------|
| YT-0490 | T10 | 100    | 1/4" (6.3 mm) | 25/100 |
|         | T25 | 100    |               |        |

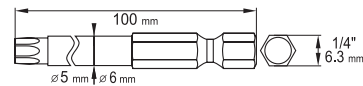
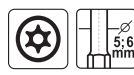

| YATO    | ⊗   | L (mm) | ⬡             | ⊞      |
|---------|-----|--------|---------------|--------|
| YT-0491 | T15 | 100    | 1/4" (6.3 mm) | 25/100 |
|         | T27 | 100    |               |        |
| YT-0492 | T20 | 100    | 1/4" (6.3 mm) | 25/100 |
|         | T30 | 100    |               |        |

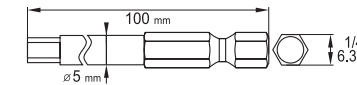

| YATO    | ⊙   | L (mm) | ⬡             | ⊞      |
|---------|-----|--------|---------------|--------|
| YT-0494 | 3.0 | 100    | 1/4" (6.3 mm) | 25/100 |
|         | 5.0 | 100    |               |        |

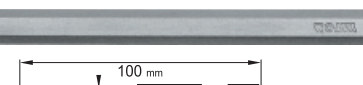
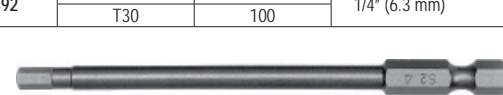

| YATO    | ⊙   | L (mm) | ⬡             | ⊞      |
|---------|-----|--------|---------------|--------|
| YT-0495 | 4.0 | 100    | 1/4" (6.3 mm) | 25/100 |
|         | 6.0 | 100    |               |        |

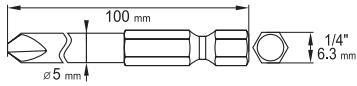

| YATO    | ⊕  | L (mm) | ⬡             | ⊞      |
|---------|----|--------|---------------|--------|
| YT-0493 | #0 | 100    | 1/4" (6.3 mm) | 25/100 |
|         | #1 | 100    |               |        |
| YT-0496 | #1 | 100    | 1/4" (6.3 mm) | 25/100 |
|         | #3 | 100    |               |        |

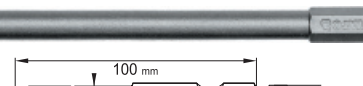
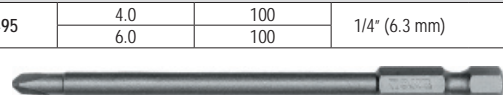

| YATO    | ⊕  | L (mm) | ⬡             | ⊞      |
|---------|----|--------|---------------|--------|
| YT-0497 | #2 | 100    | 1/4" (6.3 mm) | 25/100 |
|         | #4 | 100    |               |        |

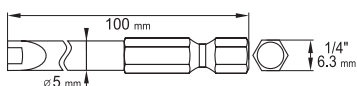

| YATO    | ⊕  | L (mm) | ⬡             | ⊞      |
|---------|----|--------|---------------|--------|
| YT-0498 | #4 | 100    | 1/4" (6.3 mm) | 25/100 |
|         | #8 | 100    |               |        |

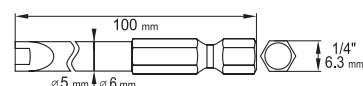

| YATO    | ⊕   | L (mm) | ⬡             | ⊞      |
|---------|-----|--------|---------------|--------|
| YT-0499 | #6  | 100    | 1/4" (6.3 mm) | 25/100 |
|         | #10 | 100    |               |        |



# Screwdrivers & screwdriver bits Wkrętaki i końcówki wkrętakowe



GB Screwdriver bit set  
D Schraubendreherbitsatz  
PL Zestaw końcówek śrubokrętowych  
RUS Набор специальных битов  
CZ Sada bitů  
H Bitkészlet  
RO Truse bit  
E Juego de llaves especiales



○ x14: L=30 mm: H4, H5, H6, H7, H8, H10, H12;  
L=75 mm: H4, H5, H6, H7, H8, H10, H12: AISI S2;  
○ x10: L=30 mm: M5, M6, M8, M10, M12;  
L=75 mm: M5, M6, M8, M10, M12: AISI S2;  
⊕ x14: L=30 mm: T20, T25, T30, T40, T45, T50, T55;  
L=75 mm: T20, T25, T30, T40, T45, T50, T55: AISI S2;  
⊕ x2: 1/2" (12.7 mm): 10 mm, 3/8" (9.5 mm): 10 mm; CrV 6150

21.8 Nm max. AISI S2 HRC 58-62

40 PCS HEX SPLINE TORX

METAL CASE & COLOR BOX

YATO YT-0400 10



7 PCS TORX

⊕ x6: L=30 mm: T25, T30, T40, T45, T50, T55: AISI S2;  
⊕ 1/2" (12.7 mm): 10 mm; CrV 6150

HANGING COLOR BOX



⊕ x14: L=30 mm: T20, T25, T30, T40, T45, T50, T55; L=75 mm: T20, T25, T30, T40, T45, T50, T55: AISI S2;  
⊕ 1/2" (12.7 mm): 10 mm; CrV 6150

15 PCS TORX

METAL CASE & COLOR BOX

YATO YT-0411 20



7 PCS HEX

○ x6: L=30 mm: H4, H5, H6, H8, H10, H12 mm: AISI S2;  
⊕ 1/2" (12.7 mm): 10 mm; CrV 6150

HANGING COLOR BOX



○ x14: L=30 mm: H4, H5, H6, H7, H8, H10, H12 mm: L=75 mm: H4, H5, H6, H7, H8, H10, H12 mm: AISI S2;  
⊕ 1/2" (12.7 mm): 10 mm; CrV 6150

15 PCS HEX

METAL CASE & COLOR BOX

YATO YT-0413 20



6 PCS SPLINE

○ x5: L=30 mm: M5, M6, M8, M10, M12: AISI S2;  
⊕ 1/2" (12.7 mm): 10 mm; CrV 6150

HANGING COLOR BOX



○ x10: L=30 mm: M5, M6, M8, M10, M12: L=75 mm: M5, M6, M8, M10, M12: AISI S2;  
⊕ 1/2" (12.7 mm): 10 mm; CrV 6150

11 PCS SPLINE

METAL CASE & COLOR BOX

YATO YT-0415 20



7 PCS TORX TAMPERPROOF

⊕ x6: L=30 mm: T25, T30, T40, T45, T50, T55: AISI S2;  
⊕ 1/2" (12.7 mm): 10 mm; CrV 6150

HANGING COLOR BOX



⊕ x14: L=30 mm: T20, T25, T30, T40, T45, T50, T55; L=75 mm: T20, T25, T30, T40, T45, T50, T55: AISI S2;  
⊕ 1/2" (12.7 mm): 10 mm; CrV 6150

15 PCS TORX TAMPERPROOF

METAL CASE & COLOR BOX

YATO YT-0417 20



8 PCS RIBE

⊕ x7: L=30 mm: M5, M6, M7, M8, M10, M12, M14: AISI S2;  
⊕ 1/2" (12.7 mm): 10 mm; CrV 6150

HANGING COLOR BOX



⊕ x14: L=30 mm: M6, M7, M8, M9, M10, M12, M14; L=75 mm: M6, M7, M8, M9, M10, M12, M14: AISI S2;  
⊕ 1/2" (12.7 mm): 10 mm; CrV 6150

15 PCS RIBE

METAL CASE & COLOR BOX

YATO YT-0419 20



⊕ x18: L=30 mm: T20, T25, T30, T40, T45, T50, T55, T60, T70: AISI S2; L=75 mm: T20, T25, T30, T40, T45, T50, T55, T60, T70: AISI S2;  
⊕ x22: L=30 mm: M4, M5, M6, M7, M8, M9, M10, M11, M12, M13, M14: AISI S2; L=75 mm: M4, M5, M6, M7, M8, M9, M10, M11, M12, M13, M14: AISI S2;  
⊕ x2: 1/2" (12.7 mm): 10 mm, 3/8" (9.5 mm): 10 mm; CrV 6150



42 PCS RIBE TORX TAMPERPROOF

METAL CASE & COLOR BOX

YATO YT-0420 10

5

- GB Nut setter
- D Magnet-Steckschlüssel mit Adapter
- PL Nasadka magnetyczna do wkrętarek
- RUS Магнитная головка для винтовёрта
- CZ Nástrčný kľúč magnetický do vrtáčky
- H Csavarbehajtó
- RO Cheie tubulara cu prindere tip mandrina
- E Boquilla magnética de destornilladora

L(mm) **48**   CrV 6150

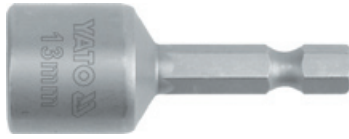

| YATO    | Hex | PCS packing | Box     |
|---------|-----|-------------|---------|
| YT-1501 | 6   | 20          | 200/600 |
| YT-1502 | 7   | 20          | 200/600 |
| YT-1503 | 8   | 20          | 200/600 |
| YT-1505 | 10  | 20          | 200/600 |
| YT-1507 | 12  | 20          | 200/600 |
| YT-1508 | 13  | 20          | 200/600 |

| YATO    | Hex | Box     |
|---------|-----|---------|
| YT-1511 | 6   | 100/200 |
| YT-1512 | 7   | 100/200 |
| YT-1513 | 8   | 100/200 |
| YT-1515 | 10  | 100/200 |
| YT-1517 | 12  | 100/200 |
| YT-1518 | 13  | 100/200 |

- GB Screwdriver bit holder
- D Bithalter
- PL Uchwyt do końcówek śrubokrętowych
- RUS Магнитный держатель
- CZ Držák na šroubovavokovékoncovky
- H Szár a csavarhúzóvégekhez
- RO Capete șurubelniță
- E Mandril para puntas

SLIDING CARD  **1/4"**  
**6.3 mm**

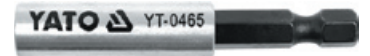

QUICK CONNECT SZYBKO-ZŁĄCZE

STAINLESS STEEL STAL NERDZEWNIA

| YATO    | Hex           | L (mm) | Box    |
|---------|---------------|--------|--------|
| YT-0464 | 1/4" (6.3 mm) | 50     | 20/200 |

| YATO    | Hex           | L (mm) | Box    |
|---------|---------------|--------|--------|
| YT-0465 | 1/4" (6.3 mm) | 60     | 20/200 |



MAGNETIC

ELASTIC COVER

QUICK CONNECT SZYBKO-ZŁĄCZE

STAINLESS STEEL STAL NERDZEWNIA

MAGNETIC

| YATO    | Hex           | L (mm) | Box    |
|---------|---------------|--------|--------|
| YT-0466 | 1/4" (6.3 mm) | 60     | 20/200 |

| YATO    | Hex           | L (mm) | Box    |
|---------|---------------|--------|--------|
| YT-0467 | 1/4" (6.3 mm) | 80     | 20/200 |

| YATO    | Hex           | L (mm) | Box    |
|---------|---------------|--------|--------|
| YT-0468 | 1/4" (6.3 mm) | 60     | 20/200 |

- GB Hex with ball with handle
- D Aufsteckschlüssel
- PL Klucz trzpieniowy z rączką
- RUS Ключ торцевой
- CZ Čepový kľúč
- H Csapkulcs
- RO Chei cu cozi
- E Llave de mandril

SVCM **55**  HRC 55-59

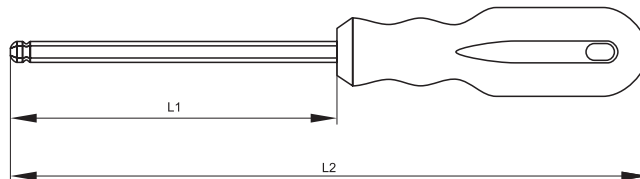

| YATO    | Hex (mm) | L1 (mm) | L2 (mm) | PCS packing | Box |
|---------|----------|---------|---------|-------------|-----|
| YT-1530 | 2.0      | 75      | 175     | 12          | 240 |
| YT-1531 | 2.5      | 75      | 175     | 12          | 240 |
| YT-1532 | 3.0      | 100     | 200     | 12          | 240 |
| YT-1533 | 4.0      | 100     | 205     | 12          | 240 |

| YATO    | Hex (mm) | L1 (mm) | L2 (mm) | PCS packing | Box |
|---------|----------|---------|---------|-------------|-----|
| YT-1534 | 5.0      | 100     | 205     | 12          | 240 |
| YT-1535 | 6.0      | 125     | 242     | 12          | 240 |
| YT-1537 | 8.0      | 150     | 278     | 6           | 120 |
| YT-1539 | 10.0     | 150     | 278     | 6           | 120 |

GB Hex key  
D Sechskant-Stiftschlüssel  
PL Klucz sześciokątny  
RUS Шестигранник  
CZ Imbusový klič  
H Imbisz kulcs  
RO Cheie imbus  
E Llave hexagonal

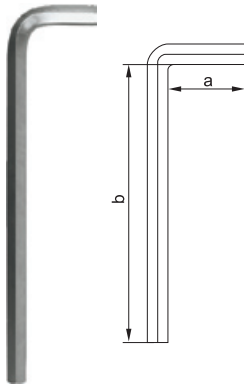

HEX CrV 6150 HRC 52-55

| YATO    | Ø (mm) | a (mm) | b (mm) | PCS packing: |
|---------|--------|--------|--------|--------------|
| YT-0546 | 6      | 24     | 110    | 20/200       |
| YT-0550 | 10     | 37     | 155    | 10/100       |

GB Hex key  
D Sechskant-Stiftschlüssel  
PL Klucz sześciokątny  
RUS Шестигранник

CZ Imbusový klič  
H Imbisz kulcs  
RO Cheie imbus  
E Llave hexagonal

POUCH



CrV 6150

5

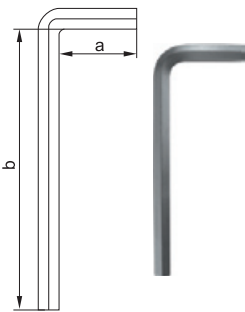

STANDARD HEX

| YATO     | Ø (mm) | a (mm) | b (mm) | PCS packing: |
|----------|--------|--------|--------|--------------|
| YT-5730  | 1.5    | 13     | 45     | 12 20/80     |
| YT-5731  | 2.0    | 15     | 49     | 12 20/80     |
| YT-5732* | 2.5    | 17     | 56     | 12 20/80     |
| YT-5733* | 3.0    | 19     | 62     | 12 20/80     |
| YT-5734* | 4.0    | 23     | 68     | 6 20/80      |
| YT-5735* | 5.0    | 27     | 77     | 6 20/80      |
| YT-5736* | 6.0    | 29     | 90     | 6 20/40      |
| YT-5737  | 7.0    | 34     | 95     | 6 20/40      |
| YT-5738  | 8.0    | 35     | 99     | 6 20/40      |
| YT-5739* | 10.0   | 39     | 109    | 6 20/40      |

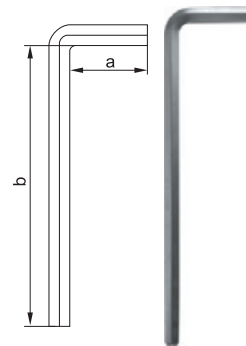

LONG HEX

| YATO     | Ø (mm) | a (mm) | b (mm) | PCS packing: |
|----------|--------|--------|--------|--------------|
| YT-5740  | 1.5    | 13     | 61     | 12 20/80     |
| YT-5741  | 2.0    | 15     | 75     | 12 20/80     |
| YT-5742  | 2.5    | 17     | 84     | 12 20/80     |
| YT-5743  | 3.0    | 18     | 88     | 12 20/80     |
| YT-5744* | 4.0    | 23     | 99     | 6 20/80      |
| YT-5745* | 5.0    | 26     | 115    | 6 20/80      |
| YT-5746* | 6.0    | 31     | 132    | 6 20/40      |
| YT-5747* | 7.0    | 32     | 139    | 6 20/40      |
| YT-5748* | 8.0    | 33     | 150    | 6 20/40      |
| YT-5749* | 10.0   | 37     | 170    | 6 20/40      |
| YT-5750* | 12.0   | 41     | 211    | 3 10/20      |
| YT-5751* | 14.0   | 52     | 238    | 3 10/20      |
| YT-5752* | 16.0   | 59     | 244    | 3 10         |
| YT-5753* | 17.0   | 60     | 250    | 1 10         |
| YT-5754* | 18.0   | 65     | 263    | 1 10         |
| YT-5755* | 19.0   | 68     | 280    | 1 10         |
| YT-5756* | 22.0   | 78     | 329    | 1 10         |

\* - product not for european market

\* - produkt nieprzeznaczony na rynek europejski

GB Hex key  
D Sechskant-Stiftschlüssel  
PL Klucz sześciokątny

RUS Шестигранник  
CZ Imbusový klič  
H Imbisz kulcs

RO Cheie imbus  
E Llave hexagonal

POUCH

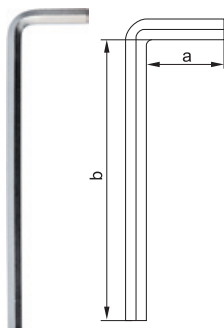

LONG HEX S2 HRC 58-62

\* - product not for european market  
\* - produkt nieprzeznaczony na rynek europejski

| YATO     | Ø (mm) | a (mm) | b (mm) | torque / moment obrotowy (Nm) | PCS packing: |
|----------|--------|--------|--------|-------------------------------|--------------|
| YT-5840* | 1.5    | 14     | 62     | 1.10                          | 12 20/80     |
| YT-5841* | 2.0    | 16     | 75     | 2.31                          | 12 20/80     |
| YT-5842* | 2.5    | 18     | 85     | 5.17                          | 12 20/80     |
| YT-5843* | 3.0    | 20     | 90     | 8.48                          | 12 20/80     |
| YT-5844* | 4.0    | 25     | 100    | 21.37                         | 6 20/80      |
| YT-5845* | 5.0    | 28     | 115    | 42.03                         | 6 20/80      |
| YT-5846* | 6.0    | 32     | 135    | 74.15                         | 6 20/40      |
| YT-5847* | 7.0    | 34     | 140    | 119.04                        | 6 20/40      |
| YT-5848* | 8.0    | 36     | 150    | 163.92                        | 6 20/40      |
| YT-5849* | 10.0   | 40     | 170    | 327.83                        | 6 20/40      |

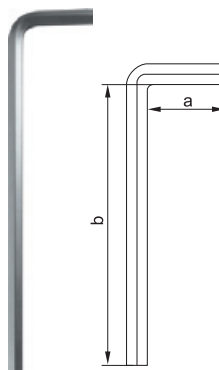

EXTRA LONG HEX CrV 6150

\* - product not for european market  
\* - produkt nieprzeznaczony na rynek europejski

| YATO     | Ø (mm) | a (mm) | b (mm) | PCS packing: |
|----------|--------|--------|--------|--------------|
| YT-5760  | 1.5    | 14     | 89     | 12 20/80     |
| YT-5761  | 2.0    | 16     | 99     | 12 20/80     |
| YT-5762* | 2.5    | 17     | 110    | 12 20/80     |
| YT-5763  | 3.0    | 19     | 124    | 12 20/80     |
| YT-5764  | 4.0    | 23     | 137    | 6 20/80      |
| YT-5765  | 5.0    | 26     | 158    | 6 20/80      |
| YT-5766  | 6.0    | 30     | 177    | 6 10/20      |
| YT-5767  | 7.0    | 32     | 186    | 6 10/20      |
| YT-5768  | 8.0    | 34     | 197    | 6 10/20      |
| YT-5769  | 10.0   | 38     | 221    | 6 10/20      |

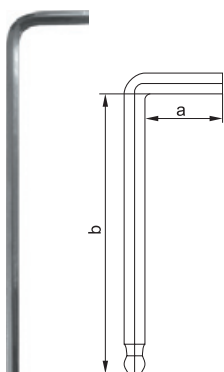

EXTRA LONG HEX WITH BALL S.A.E. 25° CrV 6150

| YATO    | Ø (mm)         | a (mm) | b (mm) | PCS packing: |
|---------|----------------|--------|--------|--------------|
| YT-5770 | 1/16" (1.6 mm) | 14     | 90     | 12 20/80     |
| YT-5771 | 5/64" (2.0 mm) | 16     | 100    | 12 20/80     |
| YT-5772 | 3/32" (2.4 mm) | 17     | 111    | 12 20/80     |
| YT-5773 | 7/64" (2.8 mm) | 18     | 116    | 12 20/80     |
| YT-5774 | 1/8" (3.2 mm)  | 19     | 123    | 12 20/80     |
| YT-5775 | 9/64" (3.6 mm) | 20     | 130    | 12 20/80     |
| YT-5776 | 5/32" (4.0 mm) | 21     | 137    | 6 10/20      |
| YT-5777 | 3/16" (4.8 mm) | 24     | 151    | 6 10/20      |
| YT-5778 | 7/32" (5.6 mm) | 25     | 165    | 6 10/20      |
| YT-5779 | 1/4" (6.3 mm)  | 28     | 183    | 6 10/20      |
| YT-5780 | 5/16" (7.9 mm) | 32     | 202    | 6 10/20      |
| YT-5781 | 3/8" (9.5 mm)  | 35     | 233    | 6 10/20      |

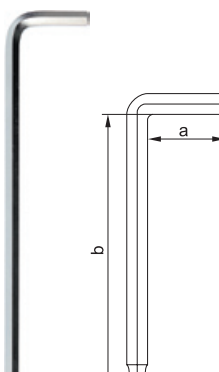

EXTRA LONG HEX WITH BALL S.A.E. S2 HRC 58-62

| YATO     | Ø (mm)         | a (mm) | b (mm) | torque / moment obrotowy (Nm) | PCS packing: |
|----------|----------------|--------|--------|-------------------------------|--------------|
| YT-5851* | 1/16" (1.6 mm) | 13     | 89     | 1.30                          | 12 20/80     |
| YT-5852* | 5/64" (2.0 mm) | 15     | 99     | 2.61                          | 12 20/80     |
| YT-5853* | 3/32" (2.4 mm) | 17     | 111    | 4.60                          | 12 20/80     |
| YT-5854* | 7/64" (2.8 mm) | 18     | 119    | 7.33                          | 12 20/80     |
| YT-5855* | 1/8" (3.2 mm)  | 19     | 125    | 10.69                         | 12 20/80     |
| YT-5856* | 9/64" (3.6 mm) | 21     | 136    | 15.54                         | 12 20/80     |
| YT-5857* | 5/32" (4.0 mm) | 24     | 139    | 23.05                         | 6 10/20      |
| YT-5858* | 3/16" (4.8 mm) | 27     | 159    | 40.00                         | 6 10/20      |
| YT-5859* | 7/32" (5.6 mm) | 30     | 170    | 57.62                         | 6 10/20      |
| YT-5860* | 1/4" (6.3 mm)  | 31     | 179    | 92.53                         | 6 10/20      |
| YT-5861* | 5/16" (7.9 mm) | 35     | 199    | 183.60                        | 6 10/20      |
| YT-5862* | 3/8" (9.5 mm)  | 39     | 223    | 315.79                        | 6 10/20      |

\* - product not for european market

\* - produkt nieprzeznaczony na rynek europejski

GB Hex key  
D Sechskant-Stiftschlüssel  
PL Klucz sześciokątny

RUS Шестигранник  
CZ Imbusový klíč  
H Imbisz kulcs

RO Cheie imbus  
E Llave hexagonal

POUCH

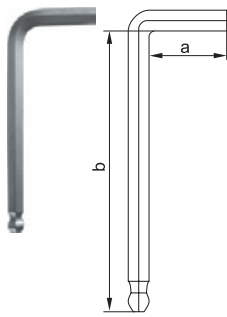

| YATO    | Ø (mm) | a (mm) | b (mm) | PCS packing | Box   |
|---------|--------|--------|--------|-------------|-------|
| YT-5785 | 1.5    | 13     | 45     | 12          | 20/80 |
| YT-5786 | 2.0    | 15     | 49     | 12          | 20/80 |
| YT-5787 | 2.5    | 17     | 56     | 12          | 20/80 |
| YT-5788 | 3.0    | 19     | 62     | 12          | 20/80 |
| YT-5789 | 4.0    | 23     | 70     | 6           | 20/80 |
| YT-5790 | 5.0    | 26     | 77     | 6           | 20/80 |
| YT-5791 | 6.0    | 30     | 91     | 6           | 20/40 |
| YT-5792 | 7.0    | 32     | 95     | 6           | 20/40 |
| YT-5793 | 8.0    | 34     | 98     | 6           | 20/40 |
| YT-5794 | 10.0   | 37     | 111    | 6           | 20/40 |

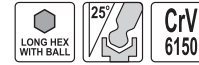
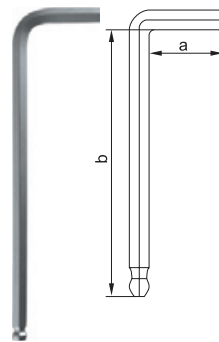

| YATO     | Ø (mm) | a (mm) | b (mm) | PCS packing | Box   |
|----------|--------|--------|--------|-------------|-------|
| YT-5795  | 1.5    | 13     | 62     | 12          | 20/80 |
| YT-5796  | 2.0    | 15     | 75     | 12          | 20/80 |
| YT-5797  | 2.5    | 17     | 85     | 12          | 20/80 |
| YT-5798  | 3.0    | 19     | 89     | 12          | 20/80 |
| YT-5799* | 4.0    | 23     | 99     | 6           | 20/80 |
| YT-5800* | 5.0    | 26     | 115    | 6           | 20/80 |
| YT-5801  | 6.0    | 29     | 135    | 6           | 20/40 |
| YT-5802  | 7.0    | 33     | 140    | 6           | 20/40 |
| YT-5803  | 8.0    | 34     | 150    | 6           | 20/40 |
| YT-5804  | 10.0   | 36     | 172    | 6           | 20/40 |

\* - product not for european market  
\* - produkt nieprzeznaczony na rynek europejski



5

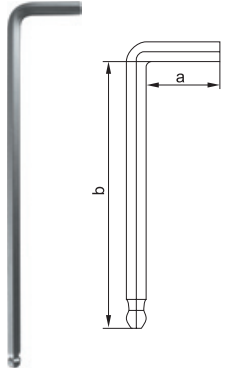

| YATO     | Ø (mm) | a (mm) | b (mm) | PCS packing | Box   |
|----------|--------|--------|--------|-------------|-------|
| YT-5805  | 1.5    | 14     | 89     | 12          | 20/80 |
| YT-5806  | 2.0    | 15     | 99     | 12          | 20/80 |
| YT-5807  | 2.5    | 18     | 110    | 12          | 20/80 |
| YT-5808  | 3.0    | 20     | 124    | 12          | 20/80 |
| YT-5809* | 4.0    | 24     | 138    | 6           | 20/80 |
| YT-5810  | 5.0    | 26     | 158    | 6           | 20/80 |
| YT-5811  | 6.0    | 30     | 179    | 6           | 10/20 |
| YT-5812  | 7.0    | 31     | 187    | 6           | 10/20 |
| YT-5813  | 8.0    | 34     | 198    | 6           | 10/20 |
| YT-5814  | 10.0   | 38     | 220    | 6           | 10/20 |

\* - product not for european market  
\* - produkt nieprzeznaczony na rynek europejski

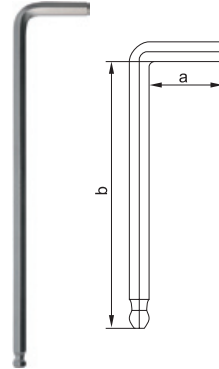

| YATO     | Ø (mm) | a (mm) | b (mm) | torque / moment obrotowy (Nm) | PCS packing | Box   |
|----------|--------|--------|--------|-------------------------------|-------------|-------|
| YT-5863* | 1.5    | 14     | 90     | 1.10                          | 12          | 20/80 |
| YT-5865* | 2.0    | 16     | 100    | 2.31                          | 12          | 20/80 |
| YT-5866* | 2.5    | 18     | 112    | 5.17                          | 12          | 20/80 |
| YT-5867* | 3.0    | 20     | 126    | 8.48                          | 12          | 20/80 |
| YT-5868* | 4.0    | 25     | 140    | 21.37                         | 6           | 20/80 |
| YT-5869* | 5.0    | 28     | 160    | 42.03                         | 6           | 20/80 |
| YT-5870* | 6.0    | 32     | 180    | 74.15                         | 6           | 10/20 |
| YT-5871* | 7.0    | 34     | 190    | 119.04                        | 6           | 10/20 |
| YT-5872* | 8.0    | 36     | 200    | 163.92                        | 6           | 10/20 |
| YT-5873* | 10.0   | 40     | 224    | 327.83                        | 6           | 10/20 |

\* - product not for european market  
\* - produkt nieprzeznaczony na rynek europejski

GB TORX key  
D TORX-Stiftschlüssel  
PL Klucz TORX  
RUS Ключ TORX  
CZ Klíč TORX  
H Kulcs TORX  
RO Cheie TORX  
E Llave TORX

POUCH

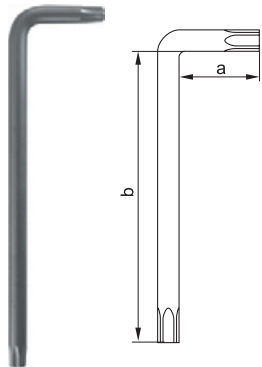

\* - product not for european market  
\* - produkt nieprzeznaczony na rynek europejski



CrV 6150

| YATO     | Ø   | a (mm) | b (mm) | PCS packing | Box   |
|----------|-----|--------|--------|-------------|-------|
| YT-5820  | T6  | 16     | 69     | 12          | 20/80 |
| YT-5821  | T7  | 16     | 73     | 12          | 20/80 |
| YT-5822  | T8  | 16     | 77     | 12          | 20/80 |
| YT-5823  | T9  | 16     | 81     | 12          | 20/80 |
| YT-5824  | T10 | 17     | 86     | 12          | 20/80 |
| YT-5825* | T15 | 18     | 89     | 6           | 20/80 |
| YT-5826* | T20 | 19     | 96     | 6           | 20/80 |
| YT-5827* | T25 | 20     | 102    | 6           | 20/80 |
| YT-5828  | T27 | 22     | 104    | 6           | 20/80 |
| YT-5829* | T30 | 24     | 114    | 6           | 20/80 |
| YT-5830  | T40 | 26     | 127    | 6           | 20/80 |
| YT-5831  | T45 | 27     | 135    | 6           | 20/40 |
| YT-5832  | T50 | 32     | 155    | 6           | 20/40 |
| YT-5833  | T55 | 35     | 164    | 6           | 20/40 |

GB Hex key set  
D Sechskant-Stiftschlüsselsatz  
PL Zestaw kluczy imbusowych

RUS Набор шестигранников  
CZ Imbusové klíče  
H Imbisz kulcs

RO Cheie imbus  
E Juego de llaves hex

PLASTIC HANGER & SLIDING CARD



12 PCS

CrV 6150

S.A.E.

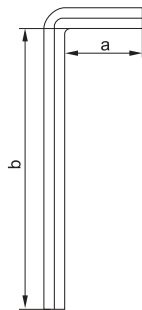

| YATO    | Ø              | a (mm) | b (mm) | Box  |
|---------|----------------|--------|--------|------|
| YT-5835 | 1/16" (1.6 mm) | 14     | 74     | 6/36 |
|         | 5/64" (2.0 mm) | 16     | 79     |      |
|         | 3/32" (2.4 mm) | 17     | 83     |      |
|         | 7/64" (2.8 mm) | 18     | 88     |      |
|         | 1/8" (3.2 mm)  | 19     | 93     |      |
|         | 9/64" (3.6 mm) | 20     | 99     |      |
|         | 5/32" (4.0 mm) | 21     | 105    |      |
|         | 3/16" (4.8 mm) | 24     | 113    |      |
|         | 7/32" (5.6 mm) | 25     | 122    |      |
|         | 1/4" (6.3 mm)  | 28     | 132    |      |
|         | 5/16" (7.9 mm) | 32     | 150    |      |
|         | 3/8" (9.5 mm)  | 35     | 170    |      |



| YATO    | Ø              | a (mm) | b (mm) | Box  |
|---------|----------------|--------|--------|------|
| YT-5836 | 1/16" (1.6 mm) | 14     | 91     | 6/36 |
|         | 5/64" (2.0 mm) | 16     | 100    |      |
|         | 3/32" (2.4 mm) | 17     | 110    |      |
|         | 7/64" (2.8 mm) | 18     | 116    |      |
|         | 1/8" (3.2 mm)  | 19     | 123    |      |
|         | 9/64" (3.6 mm) | 20     | 130    |      |
|         | 5/32" (4.0 mm) | 21     | 132    |      |
|         | 3/16" (4.8 mm) | 24     | 150    |      |
|         | 7/32" (5.6 mm) | 25     | 165    |      |
|         | 1/4" (6.3 mm)  | 28     | 185    |      |
|         | 5/16" (7.9 mm) | 32     | 200    |      |
|         | 3/8" (9.5 mm)  | 35     | 233    |      |

# Screwdrivers & screwdriver bits Wkrętaki i końcówki wkrętakowe



GB Hex key set  
D Sechskant-Stiftschlüsselsatz  
PL Zestaw kluczy imbusowych  
RUS Набор шестигранных

CZ Imbusové klíče  
H Imbisz kulcs  
RO Chei imbus  
E Juego de llaves hex

PLASTIC HANGER  
& SLIDING CARD



12  
PCS

CrV  
6150

S.A.E.

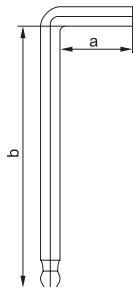

| YATO | Ø              | a (mm) | b (mm) |      |
|------|----------------|--------|--------|------|
|      | 1/16" (1.6 mm) | 14     | 74     | 6/36 |
|      | 5/64" (2.0 mm) | 16     | 79     |      |
|      | 3/32" (2.4 mm) | 17     | 83     |      |
|      | 7/64" (2.8 mm) | 18     | 88     |      |
|      | 1/8" (3.2 mm)  | 19     | 93     |      |
|      | 9/64" (3.6 mm) | 20     | 99     |      |
|      | 5/32" (4.0 mm) | 21     | 105    |      |
|      | 3/16" (4.8 mm) | 24     | 113    |      |
|      | 7/32" (5.6 mm) | 25     | 122    |      |
|      | 1/4" (6.3 mm)  | 28     | 132    |      |
|      | 5/16" (7.9 mm) | 32     | 150    |      |
|      | 3/8" (9.5 mm)  | 35     | 170    |      |



| YATO | Ø              | a (mm) | b (mm) |      |
|------|----------------|--------|--------|------|
|      | 1/16" (1.6 mm) | 14     | 91     | 6/36 |
|      | 5/64" (2.0 mm) | 16     | 100    |      |
|      | 3/32" (2.4 mm) | 17     | 110    |      |
|      | 7/64" (2.8 mm) | 18     | 116    |      |
|      | 1/8" (3.2 mm)  | 19     | 123    |      |
|      | 9/64" (3.6 mm) | 20     | 130    |      |
|      | 5/32" (4.0 mm) | 21     | 132    |      |
|      | 3/16" (4.8 mm) | 24     | 150    |      |
|      | 7/32" (5.6 mm) | 25     | 165    |      |
|      | 1/4" (6.3 mm)  | 28     | 185    |      |
|      | 5/16" (7.9 mm) | 32     | 200    |      |
|      | 3/8" (9.5 mm)  | 35     | 233    |      |

GB Hex key set  
D Sechskant-Stiftschlüsselsatz  
PL Zestaw kluczy imbusowych  
RUS Набор шестигранных

CZ Imbusové klíče  
H Imbisz kulcs  
RO Chei imbus  
E Juego de llaves hex

PLASTIC HANGER  
& SLIDING CARD



S2

HRC  
58-62

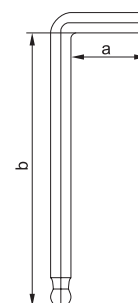
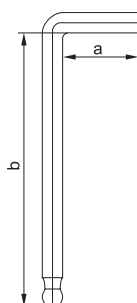
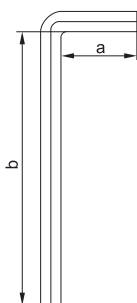

9  
PCS

LONG  
HEX

\* - product not  
for european market  
\* - produkt  
nieprzeznaczony  
na rynek europejski

| YATO | Ø    | a (mm) | b (mm) |      |
|------|------|--------|--------|------|
|      | 1.5  | 14     | 62     | 6/36 |
|      | 2.0  | 16     | 75     |      |
|      | 2.5  | 18     | 85     |      |
|      | 3.0  | 20     | 90     |      |
|      | 4.0  | 25     | 100    |      |
|      | 5.0  | 28     | 115    |      |
|      | 6.0  | 32     | 135    |      |
|      | 8.0  | 36     | 150    |      |
|      | 10.0 | 40     | 170    |      |

9  
PCS

EXTRA LONG  
HEX  
WITH BALL

\* - product not  
for european market  
\* - produkt  
nieprzeznaczony  
na rynek europejski

| YATO | Ø    | a (mm) | b (mm) |      |
|------|------|--------|--------|------|
|      | 1.5  | 14     | 90     | 6/36 |
|      | 2.0  | 16     | 100    |      |
|      | 2.5  | 18     | 112    |      |
|      | 3.0  | 20     | 126    |      |
|      | 4.0  | 25     | 140    |      |
|      | 5.0  | 28     | 160    |      |
|      | 6.0  | 32     | 180    |      |
|      | 8.0  | 36     | 200    |      |
|      | 10.0 | 40     | 224    |      |

12  
PCS

EXTRA LONG  
HEX  
WITH BALL

S.A.E.

25°

\* - product not  
for european market  
\* - produkt  
nieprzeznaczony  
na rynek europejski

| YATO | Ø              | a (mm) | b (mm) |      |
|------|----------------|--------|--------|------|
|      | 1/16" (1.6 mm) | 13     | 89     | 6/36 |
|      | 5/64" (2.0 mm) | 15     | 99     |      |
|      | 3/32" (2.4 mm) | 17     | 111    |      |
|      | 7/64" (2.8 mm) | 18     | 119    |      |
|      | 1/8" (3.2 mm)  | 19     | 125    |      |
|      | 9/64" (3.6 mm) | 21     | 136    |      |
|      | 5/32" (4.0 mm) | 24     | 139    |      |
|      | 3/16" (4.8 mm) | 27     | 159    |      |
|      | 7/32" (5.6 mm) | 30     | 170    |      |
|      | 1/4" (6.3 mm)  | 31     | 179    |      |
|      | 5/16" (7.9 mm) | 35     | 199    |      |
|      | 3/8" (9.5 mm)  | 39     | 223    |      |

GB Hex key set  
 D Sechkant-Stiftschlüsselsatz  
 PL Zestaw kluczy imbusowych  
 RUS Набор шестигранных

CZ Imbusové klíče  
 H Imbisz kulcs  
 RO Chei imbus  
 E Juego de llaves hex

PLASTIC HANGER  
 & SLIDING CARD



HEX  
 CrV  
 6150  
 HRC  
 52-55

9  
 PCS

9  
 PCS

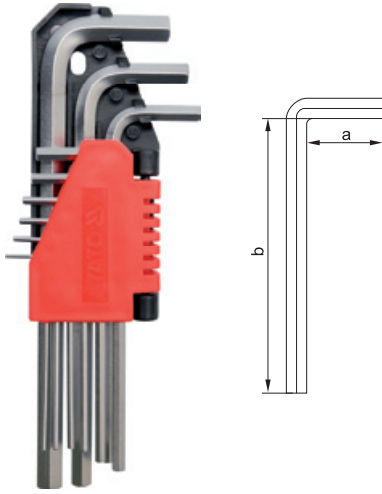

| YATO    | ⌀ (mm) | a (mm) | b (mm) |      |
|---------|--------|--------|--------|------|
| YT-0500 | 1.5    | 15     | 74     | 6/36 |
|         | 2.0    | 16     | 81     |      |
|         | 2.5    | 18     | 88     |      |
|         | 3.0    | 21     | 95     |      |
|         | 4.0    | 23     | 109    |      |
|         | 5.0    | 28     | 121    |      |
|         | 6.0    | 31     | 135    |      |
|         | 8.0    | 35     | 157    |      |
|         | 10.0   | 39     | 174    |      |

| YATO    | ⌀ (mm) | a (mm) | b (mm) |      |
|---------|--------|--------|--------|------|
| YT-0501 | 1.5    | 15     | 90     | 6/36 |
|         | 2.0    | 16     | 96     |      |
|         | 2.5    | 18     | 112    |      |
|         | 3.0    | 21     | 125    |      |
|         | 4.0    | 23     | 142    |      |
|         | 5.0    | 28     | 157    |      |
|         | 6.0    | 31     | 180    |      |
|         | 8.0    | 35     | 201    |      |
|         | 10.0   | 39     | 225    |      |

9  
 PCS

10  
 PCS

| YATO    | ⌀ (mm) | a (mm) | b (mm) |      |
|---------|--------|--------|--------|------|
| YT-0502 | 2.0    | 16     | 81     | 6/36 |
|         | 2.5    | 18     | 88     |      |
|         | 3.0    | 21     | 95     |      |
|         | 4.0    | 23     | 109    |      |
|         | 5.0    | 28     | 121    |      |
|         | 6.0    | 31     | 135    |      |
|         | 7.0    | 33     | 145    |      |
|         | 8.0    | 35     | 157    |      |
|         | 10.0   | 39     | 174    |      |

| YATO    | ⌀ (mm) | a (mm) | b (mm) |      |
|---------|--------|--------|--------|------|
| YT-0508 | 2.0    | 16     | 81     | 6/36 |
|         | 2.5    | 18     | 88     |      |
|         | 3.0    | 21     | 95     |      |
|         | 4.0    | 23     | 109    |      |
|         | 5.0    | 28     | 121    |      |
|         | 6.0    | 31     | 135    |      |
|         | 7.0    | 33     | 145    |      |
|         | 8.0    | 35     | 157    |      |
|         | 10.0   | 39     | 174    |      |
|         | 12.0   | 42     | 180    |      |

9  
 PCS

9  
 PCS

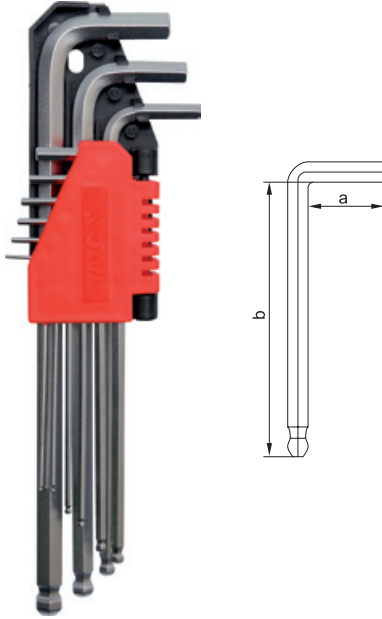

| YATO    | ⌀ (mm) | a (mm) | b (mm) |      |
|---------|--------|--------|--------|------|
| YT-0505 | 1.5    | 15     | 74     | 6/36 |
|         | 2.0    | 16     | 81     |      |
|         | 2.5    | 18     | 88     |      |
|         | 3.0    | 21     | 95     |      |
|         | 4.0    | 23     | 109    |      |
|         | 5.0    | 28     | 121    |      |
|         | 6.0    | 31     | 135    |      |
|         | 8.0    | 35     | 157    |      |
|         | 10.0   | 39     | 174    |      |

| YATO    | ⌀ (mm) | a (mm) | b (mm) |      |
|---------|--------|--------|--------|------|
| YT-0506 | 1.5    | 15     | 90     | 6/36 |
|         | 2.0    | 16     | 96     |      |
|         | 2.5    | 18     | 112    |      |
|         | 3.0    | 21     | 125    |      |
|         | 4.0    | 23     | 142    |      |
|         | 5.0    | 28     | 157    |      |
|         | 6.0    | 31     | 180    |      |
|         | 8.0    | 35     | 201    |      |
|         | 10.0   | 39     | 225    |      |

9  
 PCS

10  
 PCS

| YATO    | ⌀ (mm) | a (mm) | b (mm) |      |
|---------|--------|--------|--------|------|
| YT-0507 | 2.0    | 16     | 81     | 6/36 |
|         | 2.5    | 18     | 88     |      |
|         | 3.0    | 21     | 95     |      |
|         | 4.0    | 23     | 109    |      |
|         | 5.0    | 28     | 121    |      |
|         | 6.0    | 31     | 135    |      |
|         | 7.0    | 33     | 145    |      |
|         | 8.0    | 35     | 157    |      |
|         | 10.0   | 39     | 174    |      |

| YATO    | ⌀ (mm) | a (mm) | b (mm) |      |
|---------|--------|--------|--------|------|
| YT-0509 | 2.0    | 16     | 81     | 6/36 |
|         | 2.5    | 18     | 88     |      |
|         | 3.0    | 21     | 95     |      |
|         | 4.0    | 23     | 109    |      |
|         | 5.0    | 28     | 121    |      |
|         | 6.0    | 31     | 135    |      |
|         | 7.0    | 33     | 145    |      |
|         | 8.0    | 35     | 157    |      |
|         | 10.0   | 39     | 174    |      |
| 12.0    | 42     | 180    |        |      |

GB Hex key set  
 D Sechkant-Stiftschlüsselsatz  
 PL Zestaw kluczy imbusowych  
 RUS Набор шестигранных

CZ Imbusové klíče  
 H Imbisz kulcs  
 RO Chei imbus  
 E Juego de llaves hex

POUCH



HEX  
 CrV  
 6150

8  
 PCS

10  
 PCS



| YATO    | ⌀ (mm) | a (mm) | b (mm) |       |
|---------|--------|--------|--------|-------|
| YT-0503 | 2.0    | 14     | 50     | 12/72 |
|         | 2.5    | 16     | 53     |       |
|         | 3.0    | 17     | 60     |       |
|         | 4.0    | 21     | 66     |       |
|         | 5.0    | 22     | 74     |       |
|         | 6.0    | 27     | 81     |       |
|         | 8.0    | 32     | 93     |       |
| 10.0    | 38     | 104    |        |       |

| YATO    | ⌀ (mm) | a (mm) | b (mm) |       |
|---------|--------|--------|--------|-------|
| YT-0504 | 1.5    | 12     | 43     | 12/72 |
|         | 2.0    | 14     | 50     |       |
|         | 2.5    | 16     | 53     |       |
|         | 3.0    | 17     | 60     |       |
|         | 4.0    | 21     | 66     |       |
|         | 5.0    | 22     | 74     |       |
|         | 6.0    | 27     | 81     |       |
|         | 7.0    | 31     | 86     |       |
|         | 8.0    | 32     | 93     |       |
|         | 10.0   | 38     | 104    |       |

# Screwdrivers & screwdriver bits

## Wkrętaki i końcówki wkrętakowe



- GB Hex key set
- D Sechskant-Stiftschlüsselsatz
- PL Zestaw kluczy imbusowych
- RUS Набор шестигранников
- CZ Imbusové klíče
- H Imbisz kulcs
- RO Chei imbus
- E Juego de llaves hex



**10**  
PCS

HEX

CrV  
6150

HRC  
52-55

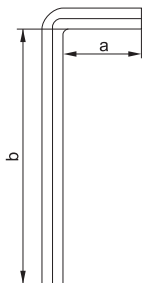

| YATO    | Ø (mm) | a (mm) | b (mm) |   |
|---------|--------|--------|--------|---|
| YT-0519 | 3.0    | 20     | 125    | 5 |
|         | 4.0    | 25     | 140    |   |
|         | 5.0    | 28     | 160    |   |
|         | 5.5    | 30     | 170    |   |
|         | 6.0    | 32     | 180    |   |
|         | 8.0    | 35     | 200    |   |
|         | 10.0   | 42     | 220    |   |
|         | 12.0   | 49     | 250    |   |
|         | 14.0   | 57     | 285    |   |
| 17.0    | 65     | 320    |        |   |

- GB TORX key set
- D TORX-Stiftschlüsselsatz
- PL Zestaw kluczy TORX
- RUS Набор ключей TORX
- CZ Souprava klíčů TORX
- H Kulcskészlet, TORX
- RO Set de chei TORX
- E Juego de llaves TORX

PLASTIC HANGER & SLIDING CARD

**9**  
PCS

TORX TAMPERPROOF

CrV  
6150

HRC  
52-55

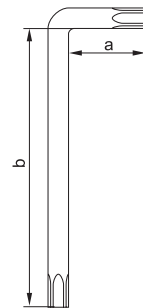

| YATO    | Ø   | a (mm) | b (mm) |      |
|---------|-----|--------|--------|------|
| YT-0511 | T10 | 15     | 72     | 6/36 |
|         | T15 | 16     | 79     |      |
|         | T20 | 17     | 86     |      |
|         | T25 | 21     | 94     |      |
|         | T27 | 24     | 107    |      |
|         | T30 | 27     | 122    |      |
|         | T40 | 32     | 133    |      |
|         | T45 | 36     | 155    |      |
|         | T50 | 38     | 174    |      |

| YATO    | Ø   | a (mm) | b (mm) |      |
|---------|-----|--------|--------|------|
| YT-0512 | T10 | 15     | 78     | 6/36 |
|         | T15 | 16     | 95     |      |
|         | T20 | 19     | 109    |      |
|         | T25 | 23     | 124    |      |
|         | T27 | 26     | 143    |      |
|         | T30 | 27     | 153    |      |
|         | T40 | 32     | 180    |      |
|         | T45 | 36     | 200    |      |
|         | T50 | 41     | 222    |      |

- GB Hex key set
- D Sechskant-Stiftschlüsselsatz
- PL Zestaw kluczy imbusowych
- RUS Набор шестигранников

- CZ Imbusové klíče
- H Imbisz kulcs
- RO Chei imbus
- E Juego de llaves hex

PLASTIC HANGER

HEX

25%

S2

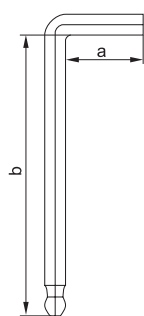

**10**  
PCS

**10**  
PCS

| YATO    | Ø (mm) | a (mm) | b (mm) |       |
|---------|--------|--------|--------|-------|
| YT-0560 | 1.27   | 12     | 73     | 12/48 |
|         | 1.5    | 14     | 76     |       |
|         | 2.0    | 16     | 82     |       |
|         | 2.5    | 18     | 89     |       |
|         | 3.0    | 18     | 99     |       |
|         | 4.0    | 21     | 104    |       |
|         | 5.0    | 27     | 115    |       |
|         | 6.0    | 32     | 138    |       |
|         | 8.0    | 35     | 161    |       |
|         | 10.0   | 38     | 179    |       |

| YATO    | Ø (mm) | a (mm) | b (mm) |       |
|---------|--------|--------|--------|-------|
| YT-0561 | 1.27   | 10     | 78     | 12/48 |
|         | 1.5    | 12     | 89     |       |
|         | 2.0    | 15     | 98     |       |
|         | 2.5    | 17     | 110    |       |
|         | 3.0    | 19     | 124    |       |
|         | 4.0    | 23     | 140    |       |
|         | 5.0    | 28     | 159    |       |
|         | 6.0    | 32     | 179    |       |
|         | 8.0    | 36     | 198    |       |
|         | 10.0   | 50     | 232    |       |

- GB TORX key set
- D TORX-Stiftschlüsselsatz
- PL Zestaw kluczy TORX
- RUS Набор ключей TORX
- CZ Souprava klíčů TORX
- H Kulcskészlet, TORX
- RO Set de chei TORX
- E Juego de llaves TORX



PLASTIC HANGER

TORX TAMPERPROOF

S2

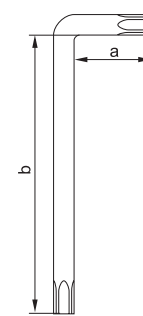

**7**  
PCS

**9**  
PCS

| YATO    | Ø   | a (mm) | b (mm) |       |
|---------|-----|--------|--------|-------|
| YT-0562 | T9  | 18     | 78     | 12/48 |
|         | T10 | 19     | 85     |       |
|         | T15 | 19     | 93     |       |
|         | T20 | 19     | 103    |       |
|         | T25 | 22     | 113    |       |
|         | T27 | 24     | 123    |       |
|         | T30 | 26     | 132    |       |

| YATO    | Ø   | a (mm) | b (mm) |       |
|---------|-----|--------|--------|-------|
| YT-0563 | T10 | 14     | 87     | 12/48 |
|         | T15 | 14     | 97     |       |
|         | T20 | 16     | 108    |       |
|         | T25 | 18     | 123    |       |
|         | T27 | 23     | 137    |       |
|         | T30 | 27     | 158    |       |
|         | T40 | 30     | 177    |       |
|         | T45 | 35     | 197    |       |
|         | T50 | 41     | 216    |       |

# 6

## Pliers & pipe wrenches Szczypce i klucze do rur





|                                  |     |
|----------------------------------|-----|
| <b>Pliers, CrV</b>               |     |
| <b>Szczypce, CrV</b>             |     |
| .....                            | 115 |
| <b>Combination pliers</b>        |     |
| Szczypce uniwersalne.....        | 115 |
| <b>Side cutting pliers</b>       |     |
| Szczypce tnące, boczne.....      | 115 |
| <b>Long nose pliers</b>          |     |
| Szczypce wydłużone, proste.....  | 115 |
| <b>Bent nose pliers</b>          |     |
| Szczypce wydłużone, wygięte..... | 115 |



|                                  |     |
|----------------------------------|-----|
| <b>Long nose pliers</b>          |     |
| Szczypce wydłużone, proste.....  | 118 |
| <b>Bent nose pliers</b>          |     |
| Szczypce wydłużone, wygięte..... | 118 |
| <b>Flat nose pliers</b>          |     |
| Szczypce płaskie.....            | 118 |
| <b>Round nose pliers</b>         |     |
| Szczypce okrągłe.....            | 118 |
| <b>End cutting pliers</b>        |     |
| Szczypce tnące, czołowe.....     | 118 |

|                                     |         |
|-------------------------------------|---------|
| <b>Pliers</b>                       |         |
| <b>Szczypce</b>                     |         |
| .....                               | 115-116 |
| <b>Combination pliers</b>           |         |
| Szczypce uniwersalne.....           | 115     |
| <b>Side cutting pliers</b>          |         |
| Szczypce tnące, boczne.....         | 115     |
| <b>Long nose pliers</b>             |         |
| Szczypce wydłużone, proste.....     | 115     |
| <b>Bent nose pliers</b>             |         |
| Szczypce wydłużone, wygięte.....    | 115     |
| <b>Flat nose pliers</b>             |         |
| Szczypce płaskie.....               | 116     |
| <b>Round nose pliers</b>            |         |
| Szczypce okrągłe.....               | 116     |
| <b>Wire stripping pliers</b>        |         |
| Szczypce do ściągania izolacji..... | 116     |
| <b>End cutting pliers</b>           |         |
| Szczypce tnące, czołowe.....        | 116     |



|                                  |     |
|----------------------------------|-----|
| <b>Mini pliers</b>               |     |
| <b>Szczypce „Mini”</b>           |     |
| .....                            | 119 |
| <b>Combination pliers</b>        |     |
| Szczypce uniwersalne.....        | 119 |
| <b>Side cutting pliers</b>       |     |
| Szczypce tnące, boczne.....      | 119 |
| <b>Long nose pliers</b>          |     |
| Szczypce wydłużone, proste.....  | 119 |
| <b>Bent nose pliers</b>          |     |
| Szczypce wydłużone, wygięte..... | 119 |
| <b>Flat nose pliers</b>          |     |
| Szczypce płaskie.....            | 119 |
| <b>Round nose pliers</b>         |     |
| Szczypce okrągłe.....            | 119 |
| <b>End cutting pliers</b>        |     |
| Szczypce tnące, czołowe.....     | 119 |



|                                     |         |
|-------------------------------------|---------|
| <b>Pliers, CrV</b>                  |         |
| <b>Szczypce, CrV</b>                |         |
| .....                               | 116-117 |
| <b>Combination pliers</b>           |         |
| Szczypce uniwersalne.....           | 116     |
| <b>Side cutting pliers</b>          |         |
| Szczypce tnące, boczne.....         | 116     |
| <b>Long nose pliers</b>             |         |
| Szczypce wydłużone, proste.....     | 116     |
| <b>Bent nose pliers</b>             |         |
| Szczypce wydłużone, wygięte.....    | 117     |
| <b>Flat nose pliers</b>             |         |
| Szczypce płaskie.....               | 117     |
| <b>Round nose pliers</b>            |         |
| Szczypce okrągłe.....               | 117     |
| <b>Wire stripping pliers</b>        |         |
| Szczypce do ściągania izolacji..... | 117     |



|                                 |     |
|---------------------------------|-----|
| <b>Pliers, CrV</b>              |     |
| <b>Szczypce, CrV</b>            |     |
| .....                           | 120 |
| <b>Combination pliers</b>       |     |
| Szczypce uniwersalne.....       | 120 |
| <b>Side cutting pliers</b>      |     |
| Szczypce tnące, boczne.....     | 120 |
| <b>Long nose pliers</b>         |     |
| Szczypce wydłużone, proste..... | 120 |
| <b>End cutting pliers</b>       |     |
| Szczypce tnące, czołowe.....    | 120 |



|                                 |     |
|---------------------------------|-----|
| <b>Pliers</b>                   |     |
| <b>Szczypce</b>                 |     |
| .....                           | 117 |
| <b>Combination pliers</b>       |     |
| Szczypce uniwersalne.....       | 117 |
| <b>Side cutting pliers</b>      |     |
| Szczypce tnące, boczne.....     | 117 |
| <b>Long nose pliers</b>         |     |
| Szczypce wydłużone, proste..... | 117 |



|                                     |     |
|-------------------------------------|-----|
| <b>Insulated pliers</b>             |     |
| <b>Szczypce izolowane</b>           |     |
| .....                               | 121 |
| <b>Combination pliers</b>           |     |
| Szczypce uniwersalne.....           | 121 |
| <b>Side cutting pliers</b>          |     |
| Szczypce tnące, boczne.....         | 121 |
| <b>Long nose pliers</b>             |     |
| Szczypce wydłużone, proste.....     | 121 |
| <b>Bent nose pliers</b>             |     |
| Szczypce wydłużone, wygięte.....    | 121 |
| <b>Wire stripping pliers</b>        |     |
| Szczypce do ściągania izolacji..... | 121 |



|                             |     |
|-----------------------------|-----|
| <b>Mini pliers</b>          |     |
| <b>Szczypce „Mini”</b>      |     |
| .....                       | 118 |
| <b>Combination pliers</b>   |     |
| Szczypce uniwersalne.....   | 118 |
| <b>Side cutting pliers</b>  |     |
| Szczypce tnące, boczne..... | 118 |



|   |     |
|---|-----|
| <b>High Leverage insulated pliers</b>     |     |
| <b>Szczypce izolowane „High Leverage”</b> |     |
| .....                                     | 122 |
| <b>Combination pliers</b>                 |     |
| Szczypce uniwersalne.....                 | 122 |
| <b>Side cutting pliers</b>                |     |
| Szczypce tnące, boczne.....               | 122 |
| <b>Long nose pliers</b>                   |     |
| Szczypce wydłużone, proste.....           | 122 |
| <b>Bent nose pliers</b>                   |     |
| Szczypce wydłużone, wygięte.....          | 122 |



Plastics & cables cutting pliers  
Szcypce do cięcia plastiku i kabli

123 

Side cutting pliers  
Szcypce tnące, boczne..... 123  
Long nose pliers  
Szcypce wydłużone, proste..... 123

Carpenter's pliers & tower pincers  
Obcęgi i szcypce

124 

Carpenter's pliers  
Obcęgi..... 124  
Tower pincers  
Szcypce tynkarskie..... 124

Heavy duty side cutting pliers  
Szcypce tnące, boczne

124 

End cutting pliers  
Szcypce tnące czołowe

124 

Circlip pliers  
Szcypce Segera

125-126 

Lock grip pliers  
Szcypce zaciskowe

127-129 

Lock grip pliers  
Szcypce zaciskowe, uniwersalne..... 127  
Welding locking pliers  
Szcypce zaciskowe, spawalnicze..... 128  
Flat locking pliers  
Szcypce zaciskowe o szerokich szczękach..... 128  
C-type welding locking pliers  
Szcypce zaciskowe, kłamrowe typu „C”..... 128  
Chain locking pliers  
Szcypce zaciskowe z łańcuchem..... 128  
Self-locking multi grip pliers  
Szcypce blacharskie..... 129

Profile connection & forming pliers  
Szcypce do łączenia i kształtowania profili

129 

Water pump pliers  
Szcypce nastawne

130 

Pipe wrenches  
Klucze do rur

130 

Tweezers  
Pęsety

131 

GB Combination pliers  
D Kombinationszange  
PL Szczypce uniwersalne  
RUS Плоскогубцы универсальные

CZ Kleště kombinované  
H Kombináltfogó  
RO Patent universal  
E Alicates universales

160 mm  
180 mm  
200 mm

HRC 44-50 BODY  
HRC 58-62 CUTTER  
CrV 55

DIN 5746



HALF DOUBLE BLISTER

- application: industry
- induction hardening
- przeznaczenie: przemysł
- hartowane indukcyjnie

| YATO    | L (mm) |      |
|---------|--------|------|
| YT-1940 | 160    | 6/60 |
| YT-1941 | 180    | 6/60 |
| YT-1942 | 200    | 6/36 |

GB Diagonal side cutting pliers  
D Seitenschneider  
PL Szczypce tnące boczne  
RUS Бокорезы

CZ Řezací kleště boční  
H Oldal csípőfogó  
RO Olește tăietor  
E Alicates corte lateral

160 mm  
190 mm  
HRC 44-50 BODY

HRC 58-62 CUTTER  
CrV 55  
DIN 5746



HALF DOUBLE BLISTER

- application: industry
- induction hardening
- przeznaczenie: przemysł
- hartowane indukcyjnie

| YATO    | L (mm) |      |
|---------|--------|------|
| YT-1947 | 160    | 6/60 |
| YT-1948 | 190    | 6/60 |

GB Long nose pliers  
D Radiozange  
PL Szczypce wydłużone proste  
RUS Тонкогубцы прямые

CZ Prodloužené kleště rovné  
H Rádiófogó, egyenes  
RO Clește cu vârf ascuțit  
E Alicates de punta

160 mm  
200 mm  
HRC 44-50 BODY

HRC 58-62 CUTTER  
CrV 55  
DIN 5746



HALF DOUBLE BLISTER

- application: industry
- induction hardening
- przeznaczenie: przemysł
- hartowane indukcyjnie

| YATO    | L (mm) |      |
|---------|--------|------|
| YT-1943 | 160    | 6/60 |
| YT-1944 | 200    | 6/60 |

GB Bent nose pliers  
D Seitenszange  
PL Szczypce wydłużone wygięte  
RUS Тонкогубцы изогнутые

CZ Prodloužené kleště ohnuté  
H Rádió - és telefonfogó, hajlított  
RO Clește cu vârf ascuțit îndoit  
E Alicates de punta curvos

160 mm  
200 mm  
HRC 44-50 BODY

HRC 58-62 CUTTER  
CrV 55  
DIN 5746



HALF DOUBLE BLISTER

- application: industry
- induction hardening
- przeznaczenie: przemysł
- hartowane indukcyjnie

| YATO    | L (mm) |      |
|---------|--------|------|
| YT-1945 | 160    | 6/60 |
| YT-1946 | 200    | 6/60 |

GB Combination pliers  
D Kombinationszange  
PL Szczypce uniwersalne  
RUS Плоскогубцы универсальные

CZ Kleště kombinované  
H Kombináltfogó  
RO Patent universal  
E Alicates universales

160 mm  
180 mm  
200 mm

DIN 5746  
NICKEL IRON FINISH



HALF DOUBLE BLISTER

| YATO    | L (mm) |      |
|---------|--------|------|
| YT-2006 | 160    | 6/60 |
| YT-2007 | 180    | 6/60 |
| YT-2008 | 200    | 6/36 |

GB Diagonal side cutting pliers  
D Seitenschneider  
PL Szczypce tnące boczne  
RUS Бокорезы

CZ Řezací kleště boční  
H Oldal csípőfogó  
RO Olește tăietor  
E Alicates corte lateral

160 mm  
180 mm

DIN 5746  
NICKEL IRON FINISH



HALF DOUBLE BLISTER

| YATO    | L (mm) |      |
|---------|--------|------|
| YT-2036 | 160    | 6/60 |
| YT-2037 | 180    | 6/60 |

GB Long nose pliers  
D Radiozange  
PL Szczypce wydłużone proste  
RUS Тонкогубцы прямые

CZ Prodloužené kleště rovné  
H Rádiófogó, egyenes  
RO Clește cu vârf ascuțit  
E Alicates de punta

160 mm  
200 mm

DIN 5746  
NICKEL IRON FINISH



HALF DOUBLE BLISTER

| YATO    | L (mm) |      |
|---------|--------|------|
| YT-2016 | 160    | 6/60 |
| YT-2018 | 200    | 6/60 |

GB Bent nose pliers  
D Seitenszange  
PL Szczypce wydłużone wygięte  
RUS Тонкогубцы изогнутые

CZ Prodloužené kleště ohnuté  
H Rádió - és telefonfogó, hajlított  
RO Clește cu vârf ascuțit îndoit  
E Alicates de punta curvos

160 mm  
200 mm

DIN 5746  
NICKEL IRON FINISH



HALF DOUBLE BLISTER

| YATO    | L (mm) |      |
|---------|--------|------|
| YT-2026 | 160    | 6/60 |
| YT-2028 | 200    | 6/60 |

GB Flat nose pliers  
D Elektriķerflachzange  
PL Szczypce płaskie  
RUS Утконосы

CZ Prodloužené kleště rovné  
H Rádiófogó, egyenes  
RO Clește cu vârf ascuțit  
E Alicates de bocas planas

160 mm DIN 5745 NICKEL IRON FINISH



HALF DOUBLE BLISTER

| YATO    | L (mm) | PCS  |
|---------|--------|------|
| YT-2029 | 160    | 6/60 |

GB Round nose pliers  
D Rundzange  
PL Szczypce okrągłe  
RUS Круглогубцы

CZ Kleště kulaté  
H Kerekcsőrű fogó  
RO Patent rotund  
E Alicates de punta redonda

160 mm DIN 5745 NICKEL IRON FINISH



HALF DOUBLE BLISTER

| YATO    | L (mm) | PCS  |
|---------|--------|------|
| YT-2030 | 160    | 6/60 |

6

GB Wire stripping pliers  
D Abisolierzange  
PL Szczypce do ściągania izolacji  
RUS Пасатижи для зачистки проводов  
CZ Kleště odizolovací na drát  
H Blankoló fogó  
RO Decablator  
E Pinzas pelacables

160 mm DIN 5745 NICKEL IRON FINISH



HALF DOUBLE BLISTER

| YATO    | L (mm) | PCS  |
|---------|--------|------|
| YT-2031 | 160    | 6/60 |

GB End cutting pliers  
D Vornschnyder  
PL Szczypce tnące czolowe  
RUS Кусачки торцевые  
CZ Kleště štípací čelní

H Homlokcsípő fogó  
H Ceste retezat  
E Cortacables frontales

160 mm 180 mm

DIN 5748 NICKEL IRON FINISH



HALF DOUBLE BLISTER

| YATO    | L (mm) | PCS  |
|---------|--------|------|
| YT-2066 | 160    | 6/60 |
| YT-2067 | 180    | 6/60 |

GB Combination pliers  
D Kombinationszange  
PL Szczypce uniwersalne  
RUS Плоскогубцы универсальные

CZ Kleště kombinované  
H Kombináltfogó  
RO Patent universal  
E Alicates universales

160 mm 180 mm 200 mm

CrV HRC 55-62



| YATO    | L (mm) | PCS | PCS |
|---------|--------|-----|-----|
| YT-6600 | 160    | 6   | 60  |
| YT-6601 | 180    | 6   | 60  |
| YT-6602 | 200    | 6   | 36  |

GB Diagonal side cutting pliers  
D Seitenschneider  
PL Szczypce tnące boczne  
RUS Бокорезы

CZ Řezací kleště boční  
H Oldal csípőfogó  
RO Olește tăietor  
E Alicates corte lateral

160 mm 180 mm

CrV HRC 55-62



| YATO    | L (mm) | PCS | PCS |
|---------|--------|-----|-----|
| YT-6610 | 160    | 6   | 60  |
| YT-6611 | 180    | 6   | 60  |

GB Diagonal side cutting pliers  
D Seitenschneider  
PL Szczypce tnące boczne  
RUS Бокорезы

CZ Řezací kleště boční  
H Oldal csípőfogó  
RO Olește tăietor  
E Alicates corte lateral

180 mm CrV HRC 55-62



| YATO    | L (mm) | PCS | PCS |
|---------|--------|-----|-----|
| YT-6612 | 180    | 6   | 60  |

GB Long nose pliers  
D Radiozange  
PL Szczypce wydłużone proste  
RUS Тонкогубцы прямые

CZ Prodloužené kleště rovné  
H Rádiófogó, egyenes  
RO Clește cu vârf ascuțit  
E Alicates de punta

160 mm 200 mm

CrV HRC 55-62



| YATO     | L (mm) | PCS | PCS |
|----------|--------|-----|-----|
| YT-6603* | 160    | 6   | 60  |
| YT-6604* | 200    | 6   | 60  |

\* - product not for european market  
\* - produkt nieprzeznaczony na rynek europejski

GB Bent nose pliers  
D Telefonzange  
PL Szczypce wydłużone wygięte  
RUS Тонкогубцы изогнутые

CZ Prodloužené kleště ohnuté  
H Rádió - és telefonfogó, hajlítót  
RO Clește cu vârf ascuțit  
E Alicates de punta curvos

160 mm 200 mm  
CrV HRC 55-62



\* - product not for european market  
\* - produkt nieprzeznaczony na rynek europejski

| YATO     | L (mm) | PCS packing | Box |
|----------|--------|-------------|-----|
| YT-6605* | 160    | 6           | 60  |
| YT-6606* | 200    | 6           | 60  |

GB Flat nose pliers  
D Elektrikerflachzange  
PL Szczypce płaskie  
RUS Утконосы

CZ Prodloužené kleště rovné  
H Rádiófogó, egyenes  
RO Clește cu vârf ascuțit  
E Alicates de bocas planas

160 mm CrV  
HRC 55-62



\* - product not for european market  
\* - produkt nieprzeznaczony na rynek europejski

| YATO     | L (mm) | PCS packing | Box |
|----------|--------|-------------|-----|
| YT-6607* | 160    | 6           | 60  |

GB Round nose pliers  
D Rundzange  
PL Szczypce okrągłe  
RUS Круглогубцы

CZ Kleště kulaté  
H Kerekcsőrű fogó  
RO Patent rotund  
E Alicates de punta redonda

160 mm CrV  
HRC 55-62



\* - product not for european market  
\* - produkt nieprzeznaczony na rynek europejski

| YATO     | L (mm) | PCS packing | Box |
|----------|--------|-------------|-----|
| YT-6608* | 160    | 6           | 60  |

GB Wire stripping pliers  
D Abisolierzange  
PL Szczypce do ściągania izolacji  
RUS Пасатижи для зачистки проводов  
CZ Kleště odizolovací na drát  
H Blankoló fogó  
RO Decablator  
E Pinzas pelacables

\* - product not for european market  
\* - produkt nieprzeznaczony na rynek europejski

160 mm CrV HRC 55-62

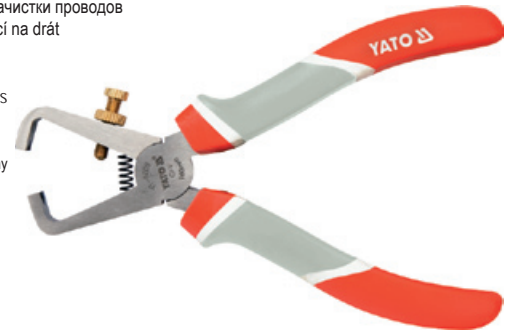

| YATO     | L (mm) | PCS packing | Box |
|----------|--------|-------------|-----|
| YT-6609* | 160    | 6           | 60  |

GB Combination pliers  
D Kombinationszange  
PL Szczypce uniwersalne  
RUS Плоскогубцы универсальные

CZ Kleště kombinované  
H Kombináltfogó  
RO Patent universal  
E Alicates universales

150 mm 200 mm  
HIGH LEVERAGE ZWIĘKSZONA SIŁA NACISKU



| YATO    | L (mm) | Box  |
|---------|--------|------|
| YT-6581 | 150    | 6/60 |
| YT-6582 | 200    | 6/36 |

GB Diagonal side cutting pliers  
D Seitenschneider  
PL Szczypce tnące boczne  
RUS Бокорезы

CZ Řezací kleště boční  
H Oldal csipőfogó  
RO Olește tăietor  
E Alicates corte lateral

150 mm HIGH LEVERAGE ZWIĘKSZONA SIŁA NACISKU



| YATO    | L (mm) | Box  |
|---------|--------|------|
| YT-6583 | 150    | 6/60 |

GB Long nose pliers  
D Radiozange  
PL Szczypce wydłużone proste  
RUS Тонкогубцы прямые

CZ Prodloužené kleště rovné  
H Rádiófogó, egyenes  
RO Clește cu vârf ascuțit  
E Alicates de punta

150 mm 200 mm  
HIGH LEVERAGE ZWIĘKSZONA SIŁA NACISKU



| YATO    | L (mm) | Box  |
|---------|--------|------|
| YT-6586 | 150    | 6/60 |
| YT-6587 | 200    | 6/36 |

GB Combination pliers  
D Kombinationszange  
PL Szczypce uniwersalne  
RUS Плоскогубцы универсальные  
CZ Kleště kombinované

H Kombináltfogó  
RO Patent universal  
E Alicates universales

115 mm

NICKEL IRON FINISH



HALF DOUBLE BLISTER



|             |        |       |
|-------------|--------|-------|
| <b>YATO</b> | L (mm) |       |
| YT-2080     | 115    | 6/120 |

GB Side cutting mini pliers  
D Seitenschneider  
PL Szczypce tnące boczne  
RUS Бокорезы  
CZ Řezací kleště boční

H Oldal csípőfogó  
RO Olește tăietor  
E Alicates corte lateral

115 mm

NICKEL IRON FINISH



HALF DOUBLE BLISTER



|             |        |       |
|-------------|--------|-------|
| <b>YATO</b> | L (mm) |       |
| YT-2081     | 115    | 6/120 |

GB Long nose mini pliers  
D Radiozange  
PL Szczypce wydłużone proste  
RUS Тонкогубцы  
CZ Prodloužené kleště rovné

H Rádiófogó, egyenes  
RO Clește cu vârf ascuțit  
E Alicates de punta

115 mm

NICKEL IRON FINISH



HALF DOUBLE BLISTER



|             |        |       |
|-------------|--------|-------|
| <b>YATO</b> | L (mm) |       |
| YT-2083     | 115    | 6/120 |

GB Bent nose mini pliers  
D Telefenzange  
PL Szczypce wydłużone wygięte  
RUS Тонкогубцы изогнутые  
CZ Prodloužené kleště ohnuté

H Rádió - és telefonfogó hajlított  
RO Clește cu vârf ascuțit îndoit  
E Alicates de punta curvos

115 mm

NICKEL IRON FINISH

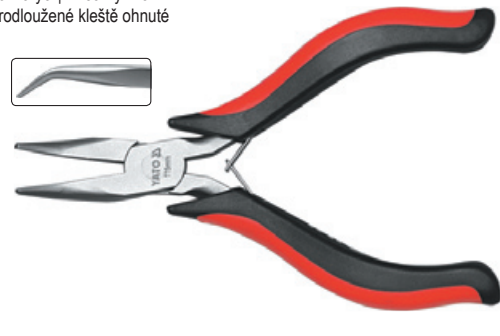

HALF DOUBLE BLISTER



|             |        |       |
|-------------|--------|-------|
| <b>YATO</b> | L (mm) |       |
| YT-2084     | 115    | 6/120 |

GB Flat nose mini pliers  
D Flachzange  
PL Szczypce płaskie  
RUS Утконосы  
CZ Prodloužené kleště rovné

H Rádiófogó, egyenes  
RO Clește cu vârf ascuțit  
E Alicates de bocas planas

115 mm

NICKEL IRON FINISH



HALF DOUBLE BLISTER



|             |        |       |
|-------------|--------|-------|
| <b>YATO</b> | L (mm) |       |
| YT-2085     | 115    | 6/120 |

GB Round nose pliers  
D Rundzange  
PL Szczypce okrągłe  
RUS Круглогубцы  
CZ Kleště kulaté

H Gömbölyfogó  
RO Patent rotund  
E Alicates de punta redonda

115 mm

NICKEL IRON FINISH



HALF DOUBLE BLISTER



|             |        |       |
|-------------|--------|-------|
| <b>YATO</b> | L (mm) |       |
| YT-2086     | 115    | 6/120 |

GB End cutting pliers  
D Vornschneider  
PL Szczypce tnące czolowe  
RUS Кусачки торцевые  
CZ Kleště štípací čelní  
H Homlokcsípő fogó  
RO Clește retezat  
E Cortacables frontales

115 mm

NICKEL IRON FINISH



HALF DOUBLE BLISTER



|             |        |       |
|-------------|--------|-------|
| <b>YATO</b> | L (mm) |       |
| YT-2082     | 115    | 6/120 |

GB Combination mini pliers  
D Kombinationszange  
PL Szczypce elektroniczne uniwersalne  
RUS Плоскогубцы универсальные  
CZ Kleště kombinované  
H Kombináltfogó  
RO Patent universal  
E Alicates universales

115 mm

HRC 55-62



\* - product not for european market  
\* - produkt nieprzeznaczony na rynek europejski



| YATO     | L (mm) | PCS packing | Box |
|----------|--------|-------------|-----|
| YT-6613* | 115    | 6           | 120 |

GB Side cutting mini pliers  
D Seitenschneider  
PL Szczypce elektroniczne tnące boczne  
RUS Бокорезы  
CZ Řezací kleště boční  
H Oldal csípőfogó  
RO Olește tăietor  
E Alicates corte lateral

115 mm

HRC 55-62



\* - product not for european market  
\* - produkt nieprzeznaczony na rynek europejski



| YATO     | L (mm) | PCS packing | Box |
|----------|--------|-------------|-----|
| YT-6614* | 115    | 6           | 120 |

GB Long nose mini pliers  
D Radiozange  
PL Szczypce elektroniczne wydłużone proste  
RUS Тонкогубцы  
CZ Prodloužené kleště rovné  
H Rádiófogó, egyenes  
RO Clește cu vârf ascuțit  
E Alicates de punta

115 mm

HRC 55-62



\* - product not for european market  
\* - produkt nieprzeznaczony na rynek europejski



| YATO     | L (mm) | PCS packing | Box |
|----------|--------|-------------|-----|
| YT-6616* | 115    | 6           | 120 |

GB Bent nose mini pliers  
D Telefonzange  
PL Szczypce elektroniczne wydłużone wygięte  
RUS Тонкогубцы изогнутые  
CZ Prodloužené kleště ohnuté  
H Rádió - és telefonfogó, hajlított  
RO Clește cu vârf ascuțit indoit  
E Alicates de punta curvos

115 mm

HRC 55-62

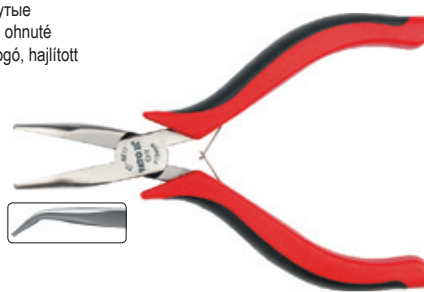

\* - product not for european market  
\* - produkt nieprzeznaczony na rynek europejski



| YATO     | L (mm) | PCS packing | Box |
|----------|--------|-------------|-----|
| YT-6617* | 115    | 6           | 120 |

GB Flat nose mini pliers  
D Flachzange  
PL Szczypce elektroniczne płaskie  
RUS Утконосы  
CZ Prodloužené kleště rovné  
H Rádiófogó, egyenes  
RO Clește cu vârf ascuțit  
E Alicates de bocas planas

115 mm

HRC 55-62



\* - product not for european market  
\* - produkt nieprzeznaczony na rynek europejski



| YATO     | L (mm) | PCS packing | Box |
|----------|--------|-------------|-----|
| YT-6618* | 115    | 6           | 120 |

GB Round nose mini pliers  
D Rundzange  
PL Szczypce elektroniczne okrągłe  
RUS Круглогубцы  
CZ Kleště kulaté  
H Gömbölyőfogó  
RO Patent rotund  
E Alicates de punta redonda

115 mm

HRC 55-62



\* - product not for european market  
\* - produkt nieprzeznaczony na rynek europejski



| YATO     | L (mm) | PCS packing | Box |
|----------|--------|-------------|-----|
| YT-6619* | 115    | 6           | 120 |

GB End cutting mini pliers  
D Vornschnaider  
PL Szczypce elektroniczne tnące czołowe  
RUS Кусачки торцевые  
CZ Kleště štipací čelní  
H Homlokcsípő fogó  
RO Clește rețezat  
E Cortacables frontales

115 mm

HRC 55-62



\* - product not for european market  
\* - produkt nieprzeznaczony na rynek europejski



| YATO     | L (mm) | PCS packing | Box |
|----------|--------|-------------|-----|
| YT-6615* | 115    | 6           | 120 |

GB Combination pliers  
D Kombinationszange  
PL Szczypce uniwersalne  
RUS Плоскогубцы универсальные

CZ Kleště kombinované  
H Kombináltfogó  
RO Patent universal  
E Alicates universales

160 mm 180 mm 200 mm  
CrV HRC 56-62



SLIDING CARD

| YATO    | L (mm) |      |
|---------|--------|------|
| YT-6620 | 160    | 6/60 |
| YT-6621 | 180    | 6/60 |
| YT-6622 | 200    | 6/36 |

GB Diagonal side cutting pliers  
D Seitenschneider  
PL Szczypce tnące boczne  
RUS Бокорезы

CZ Řezací kleště boční  
H Oldal csípőfogó  
RO Olește tăietor  
E Alicates corte lateral

140 mm 160 mm 180 mm  
CrV HRC 56-62



SLIDING CARD

| YATO    | L (mm) |      |
|---------|--------|------|
| YT-6628 | 140    | 6/60 |
| YT-6629 | 160    | 6/60 |
| YT-6630 | 180    | 6/60 |

GB Long nose pliers  
D Radiozange  
PL Szczypce wydłużone proste  
RUS Тонкогубцы прямые

CZ Prodloužené kleště rovné  
H Rádiófogó, egyenes  
RO Clește cu vârf ascuțit  
E Alicates de punta

160 mm 200 mm  
CrV HRC 56-62



SLIDING CARD

| YATO    | L (mm) |      |
|---------|--------|------|
| YT-6623 | 160    | 6/60 |
| YT-6624 | 200    | 6/36 |

GB Long nose pliers  
D Radiozange  
PL Szczypce wydłużone proste  
RUS Тонкогубцы прямые

CZ Prodloužené kleště rovné  
H Rádiófogó, egyenes  
RO Clește cu vârf ascuțit  
E Alicates de punta

160 mm CrV HRC 56-62



SLIDING CARD

| YATO    | L (mm) |      |
|---------|--------|------|
| YT-6625 | 160    | 6/60 |

GB Long nose pliers  
D Radiozange  
PL Szczypce wydłużone proste  
RUS Тонкогубцы прямые

CZ Prodloužené kleště rovné  
H Rádiófogó, egyenes  
RO Clește cu vârf ascuțit  
E Alicates de punta

160 mm CrV HRC 56-62



SLIDING CARD

| YATO    | L (mm) |      |
|---------|--------|------|
| YT-6626 | 160    | 6/60 |

GB End cutting pliers  
D Vornschnaider  
PL Szczypce tnące czolowe  
RUS Кусачки торцевые  
CZ Kleště štípací čelní

H Homlokcsípő fogó  
RO Clește rețezat  
E Cortacables frontales

160 mm CrV HRC 56-62



SLIDING CARD

| YATO    | L (mm) |      |
|---------|--------|------|
| YT-6631 | 160    | 6/60 |



- GB Combination pliers  
D Kombinationszange  
PL Szczypce uniwersalne  
RUS Плоскогубцы универсальные  
CZ Kleště kombinované  
H Kombináltfogó  
RO Patent universal  
E Alicates universales



160 mm 180 mm 200 mm 1000 V DIN 5746 CrV



05 VDE  
CERTIFICATE  
-IEC60900:2004

HALF  
DOUBLE  
BLISTER



| YATO  | L (mm) |  |
|--|--------|---|
| YT-2101  | 160    | 6/60  |
| YT-2102  | 180    | 6/60  |
| YT-2103  | 200    | 6/60  |

- GB Diagonal side cutting pliers  
D Seitenschneider  
PL Szczypce tnące boczne  
RUS Бокорезы  
CZ Řezací kleště boční  
H Oldal csípőfogó  
RO Olește tăietor  
E Alicates corte lateral



160 mm 180 mm 1000 V DIN 5749 CrV



05 VDE  
CERTIFICATE  
-EN60900:2004

HALF  
DOUBLE  
BLISTER



| YATO  | L (mm) |  |
|--|--------|---|
| YT-2109  | 160    | 6/60  |
| YT-2110  | 180    | 6/60  |

- GB Long nose pliers  
D Radiozange  
PL Szczypce wydłużone proste  
RUS Тонкогубцы прямые  
CZ Prodloužené kleště rovné  
H Rádiófogó, egyenes  
RO Clește cu vârf ascuțit  
E Alicates de punta



160 mm 200 mm 1000 V DIN 5745 CrV



05 VDE  
CERTIFICATE  
-EN60900:2004

HALF  
DOUBLE  
BLISTER



| YATO  | L (mm) |  |
|--|--------|---|
| YT-2104  | 160    | 6/60  |
| YT-2105  | 200    | 6/60  |

- GB Bent nose pliers  
D Telefonzange  
PL Szczypce wydłużone wygięte  
RUS Тонкогубцы изогнутые  
CZ Prodloužené kleště ohnuté  
H Rádió - és telefonfogó, hajlított  
RO Clește cu vârf ascuțit îndoit  
E Alicates de punta curvos



200 mm 1000 V DIN 5745 CrV



05 VDE  
CERTIFICATE  
-EN60900:2004

HALF  
DOUBLE  
BLISTER



| YATO  | L (mm) |  |
|--|--------|---|
| YT-2107  | 200    | 6/60  |

- GB Wire stripping pliers  
D Abisolierzange  
PL Szczypce do ściągania izolacji  
RUS Пассажжи для зачистки проводов  
CZ Kleště odizolovací na drát  
H Blankoló fogó  
RO Decablator  
E Pinzas pelacables



160 mm 1000 V DIN 5745 CrV



05 VDE  
CERTIFICATE  
-EN60900:2004

HALF  
DOUBLE  
BLISTER



| YATO  | L (mm) |  |
|--|--------|---|
| YT-2112  | 160    | 6/60  |

GB Combination pliers  
 D Kombinationszange  
 PL Szczypce uniwersalne  
 RUS Плоскогубцы универсальные  
 CZ Kleště kombinované  
 H Kombinálfogó  
 RO Patent universal  
 E Alicates universales



- application: industry
- HIGH LEVERAGE system
  - stronger jaws pressure by 35%
- induction hardening
- przeznaczenie: przemysł
- system HIGH LEVERAGE
  - większa siła nacisku szczęk o 35%
- hartowane indukcyjnie

|  |        |           |          |
|--|--------|-----------|----------|
| 180 mm                                   | 200 mm | 1000 V    | DIN 5746 |
| HIGH LEVERAGE<br>ZWIĘKSZONA SIŁA NACISKU |        | HRC 58-62 | CrV 6140 |

PLASTIC HANGER



05 VDE  
 CERTIFICATE  
 -EN60900:2004

| YATO     | L (mm) |      |
|----------|--------|------|
| YT-2121* | 180    | 4/48 |
| YT-2122* | 200    | 4/48 |

\* - product not for european market  
 \* - produkt nieprzeznaczony na rynek europejski

6

GB Diagonal side cutting pliers  
 D Seitenschneider  
 PL Szczypce tnące boczne  
 RUS Бокорезы  
 CZ Řezací kleště boční  
 H Oldal csípőfogó  
 RO Olește tăietor  
 E Alicates corte lateral



- application: industry
- HIGH LEVERAGE system
  - stronger jaws pressure by 35%
- induction hardening
- przeznaczenie: przemysł
- system HIGH LEVERAGE
  - większa siła nacisku szczęk o 35%
- hartowane indukcyjnie

|  |        |           |          |
|--|--------|-----------|----------|
| 180 mm                                   | 200 mm | 1000 V    | DIN 5746 |
| HIGH LEVERAGE<br>ZWIĘKSZONA SIŁA NACISKU |        | HRC 58-62 | CrV 6140 |

PLASTIC HANGER



05 VDE  
 CERTIFICATE  
 -EN60900:2004

| YATO     | L (mm) |      |
|----------|--------|------|
| YT-2123* | 180    | 4/48 |
| YT-2124* | 200    | 4/48 |

\* - product not for european market  
 \* - produkt nieprzeznaczony na rynek europejski

GB Long nose pliers  
 D Radiozange  
 PL Szczypce wydłużone proste  
 RUS Тонкогубцы прямые  
 CZ Prodloužené kleště rovné  
 H Rádiófogó, egyenes  
 RO Clește cu vârf ascuțit  
 E Alicates de punta



- application: industry
- HIGH LEVERAGE system
  - stronger jaws pressure by 35%
- induction hardening
- przeznaczenie: przemysł
- system HIGH LEVERAGE
  - większa siła nacisku szczęk o 35%
- hartowane indukcyjnie

|  |        |           |          |
|--|--------|-----------|----------|
| 160 mm                                   | 200 mm | 1000 V    | DIN 5746 |
| HIGH LEVERAGE<br>ZWIĘKSZONA SIŁA NACISKU |        | HRC 58-62 | CrV 6140 |

PLASTIC HANGER



05 VDE  
 CERTIFICATE  
 -EN60900:2004

| YATO     | L (mm) |      |
|----------|--------|------|
| YT-2126* | 160    | 4/48 |
| YT-2127* | 200    | 4/48 |

\* - product not for european market  
 \* - produkt nieprzeznaczony na rynek europejski

GB Bent nose pliers  
 D Telefonzange  
 PL Szczypce wydłużone wygięte  
 RUS Тонкогубцы изогнутые  
 CZ Prodloužené kleště ohnuté  
 H Rádió - és telefonfogó, hajlított  
 RO Clește cu vârf ascuțit îndoit  
 E Alicates de punta curvos



- application: industry
- HIGH LEVERAGE system
  - stronger jaws pressure by 35%
- induction hardening
- przeznaczenie: przemysł
- system HIGH LEVERAGE
  - większa siła nacisku szczęk o 35%
- hartowane indukcyjnie

|  |        |           |          |
|--|--------|-----------|----------|
| 160 mm                                   | 200 mm | 1000 V    | DIN 5746 |
| HIGH LEVERAGE<br>ZWIĘKSZONA SIŁA NACISKU |        | HRC 58-62 | CrV 6140 |

PLASTIC HANGER



05 VDE  
 CERTIFICATE  
 -EN60900:2004

| YATO     | L (mm) |      |
|----------|--------|------|
| YT-2128* | 160    | 4/48 |
| YT-2129* | 200    | 4/48 |

\* - product not for european market  
 \* - produkt nieprzeznaczony na rynek europejski

GB Side cutting pliers  
D Seitenschneider  
PL Szczypce tnące boczne  
RUS Бокорезы  
CZ Řezací kleště boční  
H Oldal csípőfogó



125 mm CrV 60  
HRC CUTTER 56-62 HRC BODY 43-48  
FOR PLASTIC max. ∅ 3 mm

SLIDING CARD

|             |        |       |
|-------------|--------|-------|
| <b>YATO</b> | L (mm) |       |
| YT-1950     | 125    | 6/120 |

GB Side cutting pliers  
D Seitenschneider  
PL Szczypce tnące boczne  
RUS Бокорезы  
CZ Řezací kleště boční  
H Oldal csípőfogó

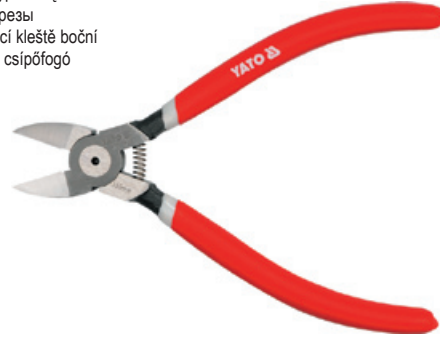

150 mm CrV 60  
HRC CUTTER 56-62 HRC BODY 43-48  
FOR PLASTIC max. ∅ 5 mm

SLIDING CARD

|             |        |       |
|-------------|--------|-------|
| <b>YATO</b> | L (mm) |       |
| YT-1951     | 150    | 6/120 |

GB Side cutting pliers  
D Seitenschneider  
PL Szczypce tnące boczne  
RUS Бокорезы  
CZ Řezací kleště boční  
H Oldal csípőfogó



180 mm CrV 60  
HRC CUTTER 56-62 HRC BODY 43-48  
FOR PLASTIC max. ∅ 6 mm

SLIDING CARD

|             |        |      |
|-------------|--------|------|
| <b>YATO</b> | L (mm) |      |
| YT-1952     | 180    | 6/60 |

GB Side cutting pliers  
D Seitenschneider  
PL Szczypce tnące boczne  
RUS Бокорезы  
CZ Řezací kleště boční  
H Oldal csípőfogó



100 mm CrV 60  
HRC CUTTER 56-62 HRC BODY 43-48  
FOR CABLE CUTTING max. ∅ 1.0 mm  
COPPER max. ∅ 1.8 mm

SLIDING CARD

|             |        |       |
|-------------|--------|-------|
| <b>YATO</b> | L (mm) |       |
| YT-1953     | 100    | 6/120 |

GB Side cutting pliers  
D Seitenschneider  
PL Szczypce tnące boczne  
RUS Бокорезы  
CZ Řezací kleště boční  
H Oldal csípőfogó



125 mm CrV 60  
HRC CUTTER 56-62 HRC BODY 43-48  
FOR CABLE CUTTING max. ∅ 1.2 mm  
COPPER max. ∅ 2.0 mm

SLIDING CARD

|             |        |       |
|-------------|--------|-------|
| <b>YATO</b> | L (mm) |       |
| YT-1954     | 125    | 6/120 |

GB Long nose pliers  
D Radiozange  
PL Szczypce wydłużone proste  
RUS Тонкогубцы прямые  
CZ Prodloužené kleště rovné  
H Rádiófogó, egyenes



125 mm CrV 60  
HRC CUTTER 56-62 HRC BODY 43-48  
STEEL max. ∅ 1.5 mm  
COPPER max. ∅ 2.6 mm

SLIDING CARD

|             |        |       |
|-------------|--------|-------|
| <b>YATO</b> | L (mm) |       |
| YT-1955*    | 125    | 6/120 |

\* - product not for european market  
\* - produkt nieprzeznaczony na rynek europejski

GB Long nose pliers  
D Radiozange  
PL Szczypce wydłużone proste  
RUS Тонкогубцы прямые  
CZ Prodloužené kleště rovné  
H Rádiófogó, egyenes  
RO Clește cu vârf ascuțit  
E Alicates de punta



150 mm CrV 60  
HRC CUTTER 56-62 HRC BODY 43-48  
STEEL max. ∅ 1.5 mm  
COPPER max. ∅ 2.6 mm

SLIDING CARD

|             |        |       |
|-------------|--------|-------|
| <b>YATO</b> | L (mm) |       |
| YT-1956     | 150    | 6/120 |

GB Carpenter's pliers  
D Kneifzange  
PL Obcęgi

RUS Клещи строительные  
CZ Kleště  
H Harapófogó

RO Cleste cuie  
E Tenazas

160 mm 180 mm 200 mm DIN 5748 NICKEL IRON FINISH



HALF DOUBLE BLISTER



| YATO    | L (mm) |      |
|---------|--------|------|
| YT-2046 | 160    | 6/60 |
| YT-2047 | 180    | 6/60 |
| YT-2048 | 200    | 6/60 |

GB Tower pincers  
D Beisszange  
PL Obcęgi tynkarskie

RUS Клещи штукатурные  
CZ Kleště štrpáci čelni  
H Rabitzfogó

RO Cleste pt. cuie  
E Tenazas de enlucido

200 mm 250 mm 275 mm DIN 5748 NICKEL IRON FINISH



HALF DOUBLE BLISTER



| YATO    | L (mm) |      |
|---------|--------|------|
| YT-2058 | 200    | 6/60 |
| YT-2060 | 250    | 6/36 |
| YT-2061 | 275    | 6/36 |

GB Tower pincers  
D Beisszange  
PL Obcęgi tynkarskie

RUS Клещи штукатурные  
CZ Kleště štrpáci čelni  
H Rabitzfogó

RO Cleste pt. cuie  
E Tenazas de enlucido

250 mm HRC 44-50 BODY HRC 58-62 CUTTER CrV 55 DIN 5746



HALF DOUBLE BLISTER



| YATO    | L (mm) |      |
|---------|--------|------|
| YT-1949 | 250    | 6/36 |

GB Heavy duty side cutting pliers  
D Seitenschneider, Schwer Typ  
PL Szczypce tnące boczne  
RUS Бокорезы усиленные  
CZ Řezací kleště boční

H Oldal csípőfogó  
RO Olește tăietor  
E Alicates de corte lateral tipo pesado

180 mm DIN 5749 NICKEL IRON FINISH



HALF DOUBLE BLISTER



| YATO    | L (mm) |      |
|---------|--------|------|
| YT-2039 | 180    | 6/60 |

GB Carpenter's pliers  
D Kneifzange  
PL Obcęgi

RUS Клещи строительные  
CZ Kleště  
H Harapófogó

RO Cleste cuie  
E Tenazas

150 mm 175 mm 200 mm CrV 50 HRC 55-60



COLOR BOX

6 PCS



| YATO    | L (mm) | cold rolled steel (mm)<br>stal walcowana na zimno (mm) | PCS<br>packing |    |
|---------|--------|--|----------------|----|
| YT-2050 | 150    | 1.5  | 6              | 60 |
| YT-2051 | 175    | 1.8  | 6              | 60 |
| YT-2052 | 200    | 2.0  | 6              | 48 |

GB Tower pincers  
D Beisszange  
PL Obcęgi tynkarskie

RUS Клещи штукатурные  
CZ Kleště štrpáci čelni  
H Rabitzfogó

RO Cleste pt. cuie  
E Tenazas de enlucido

200 mm 225 mm 250 mm 275 mm CrV 50 HRC 55-62



COLOR BOX

6 PCS



| YATO     | L (mm) | cold rolled steel (mm)<br>stal walcowana na zimno (mm) | PCS<br>packing |    |
|----------|--------|--|----------------|----|
| YT-2054* | 200    | 1.2  | 6              | 60 |
| YT-2055  | 225    | 1.8  | 6              | 60 |
| YT-2056  | 250    | 2.0  | 6              | 48 |
| YT-2057  | 275    | 2.2  | 6              | 24 |

\* - product not for european market  
\* - produkt nieprzeznaczony na rynek europejski

GB End cutting pliers  
D Vornsneider  
PL Szczypce tnące czołowe

RUS Кусачки торцевые  
CZ Kleště štrpáci čelni  
H Homloksípő fogó

RO Cleste retezat  
E Cortacables frontales

150 mm 175 mm 200 mm CrV 50 HRC 55-60



COLOR BOX

6 PCS











| YATO    | L (mm) | cold rolled steel (mm)<br>stal walcowana na zimno (mm) | PCS<br>packing |    |
|---------|--------|--|----------------|----|
| YT-2062 | 150    | 1.2  | 6              | 60 |
| YT-2063 | 175    | 1.5  | 6              | 48 |
| YT-2064 | 200    | 1.8  | 6              | 48 |

GB Circlip pliers  
D Seegeringzange  
PL Szczypce Segera  
RUS Съёмник стопорных колец

CZ Kleště Segera  
H Seegerfogó belső  
RO Clește Seger  
E Alicates Seger

5 PCS  
160 mm  
Ø mm 10-50

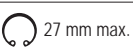

|  |   |            |   |            |
|--|---|------------|---|------------|
|  |  | 23 mm max. |  | 20 mm max. |
|  |  | 28 mm max. |  | 23 mm max. |
|  |  | 30 mm max. |  | 27 mm max. |



SLIDING CARD

| YATO    | L (mm) |  |
|---------|--------|---|
| YT-2130 | 160    | 20/60   |

GB Circlip pliers  
D Seegeringzange  
PL Szczypce Segera  
RUS Съёмник стопорных колец

CZ Kleště Segera  
H Seegerfogó belső  
RO Clește Seger  
E Alicates Seger



180 mm  
HRC 42-48  
CrV 50



| YATO    | L (mm) |  |
|---------|--------|---|
| YT-2136 | 180    | 6/24  |

| YATO    | L (mm) |  |
|---------|--------|---|
| YT-2138 | 180    | 6/24  |



| YATO    | L (mm) |  |
|---------|--------|---|
| YT-2137 | 180    | 6/24  |

| YATO    | L (mm) |  |
|---------|--------|---|
| YT-2139 | 180    | 6/24  |

GB Circlip pliers  
 D Seegeringgzange  
 PL Szczypce Segera  
 RUS Съёмник  
 стопорных колец  
 CZ Kleště Segera  
 H Segerfogó belseő  
 RO Clește Seger  
 E Alicates Seger



150 mm 200 mm  
 CrV NICKEL IRON FINISH



GB Circlip pliers  
 D Seegeringgzange  
 PL Szczypce Segera  
 RUS Съёмник  
 стопорных колец  
 CZ Kleště Segera  
 H Segerfogó belseő  
 RO Clește Seger  
 E Alicates Seger



125 mm 175 mm 225 mm 325 mm  
 NICKEL FINISH CrV



\* - product not for european market  
 \* - produkt nieprzeznaczony na rynek europejski

6

| YATO    | L (mm) | PCS packing |     |
|---------|--------|-------------|-----|
| YT-2140 | 150    | 6           | 120 |
| YT-2144 | 200    | 6           | 60  |

| YATO     | L (mm) |       |
|----------|--------|-------|
| YT-1980* | 125    | 6/120 |
| YT-1984* | 175    | 6/96  |
| YT-1988  | 225    | 6/60  |
| YT-1992  | 325    | 6/48  |



| YATO    | L (mm) | PCS packing |     |
|---------|--------|-------------|-----|
| YT-2141 | 150    | 6           | 120 |
| YT-2145 | 200    | 6           | 60  |



\* - product not for european market  
 \* - produkt nieprzeznaczony na rynek europejski

| YATO     | L (mm) |       |
|----------|--------|-------|
| YT-1981  | 125    | 6/120 |
| YT-1985* | 175    | 6/96  |
| YT-1989  | 225    | 6/60  |
| YT-1993  | 325    | 6/48  |



| YATO    | L (mm) | PCS packing |    |
|---------|--------|-------------|----|
| YT-2142 | 150    | 6           | 60 |
| YT-2146 | 200    | 6           | 60 |



\* - product not for european market  
 \* - produkt nieprzeznaczony na rynek europejski

| YATO     | L (mm) |       |
|----------|--------|-------|
| YT-1982* | 125    | 6/120 |
| YT-1986* | 175    | 6/96  |
| YT-1990  | 225    | 6/60  |
| YT-1994  | 325    | 6/48  |



| YATO    | L (mm) | PCS packing |     |
|---------|--------|-------------|-----|
| YT-2143 | 150    | 6           | 120 |
| YT-2147 | 200    | 6           | 60  |



\* - product not for european market  
 \* - produkt nieprzeznaczony na rynek europejski

| YATO     | L (mm) |       |
|----------|--------|-------|
| YT-1983* | 125    | 6/120 |
| YT-1987* | 175    | 6/96  |
| YT-1991  | 225    | 6/60  |
| YT-1995  | 325    | 6/48  |

GB Lock grip pliers  
D Gripzange  
PL Szczypce Morse'a  
RUS Зажим ручной

CZ Kleště Morse'a  
H Morse fogó  
RO Clește Morse  
E Alicates Morse



140 mm  
240 mm  
180 mm  
WR TYPE







CrV

165 mm

220 mm

CD TYPE

| YATO  | L (mm) |  |
|--|--------|---|
| YT-2151  | 140    | 6/48  |
| YT-2152  | 180    | 6/36  |
| YT-2153  | 240    | 6/36  |



| YATO  | L (mm) |  |
|--|--------|---|
| YT-2155  | 165    | 6/48  |
| YT-2156  | 220    | 6/36  |

GB Locking pliers  
D Klemmzange  
PL Szczypce zaciskowe  
RUS Клещи давяльные



CZ Kleště samosvorné  
H Patentfogó  
RO Clește de strângere  
E Pinzas de tornillo (de apriete)



125 mm

| YATO  | L (mm) |  |
|--|--------|--|
| YT-2449  | 125    | 6/24   |

250 mm



| YATO  | L (mm) |  |
|---|--------|--|
| YT-2453   | 250    | 6/24   |

CrMo

6





180 mm



| YATO  | L (mm) |  |
|---|--------|---|
| YT-2450   | 180    | 6/24  |



150 mm



| YATO  | L (mm) |  |
|--|--------|---|
| YT-2459  | 150    | 6/24  |

250 mm

| YATO  | L (mm) |  |
|---|--------|---|
| YT-2451   | 250    | 6/24  |





180 mm

| YATO  | L (mm) |  |
|---|--------|---|
| YT-2452   | 180    | 6/24  |



225 mm

| YATO  | L (mm) |  |
|--|--------|---|
| YT-2460  | 225    | 6/24  |

GB Locking pliers  
D Klemmzange  
PL Szczypce zaciskowe  
RUS Клещи давяльные  
CZ Kleště samosvorné

H Patentfogó  
RO Clește de strângere  
E Pinzas de tornillo (de apriete)

HALF  
DOUBLE  
BLISTER



CrMo



180  
mm

0-36  
mm

|             |        |      |
|-------------|--------|------|
| <b>YATO</b> | L (mm) |      |
| YT-2472     | 180    | 6/24 |



250  
mm

0-42  
mm

|             |        |      |
|-------------|--------|------|
| <b>YATO</b> | L (mm) |      |
| YT-2473     | 250    | 6/24 |



250  
mm

0-42  
mm

|             |        |      |
|-------------|--------|------|
| <b>YATO</b> | L (mm) |      |
| YT-2476     | 250    | 6/24 |

GB C-type welding locking pliers  
D Klemm- und Klammerzange vom Typ „C“  
PL Szczypce zaciskowe kłamrowe typu „C“  
RUS Клещи давяльные типа „C“

CZ Kleště samosvorné upinací typu „C“  
H „C“ fogó  
RO Clește de strângere cu clemă tip „C“  
E Pinzas de tornillo (de apriete) de grapa tipo „C“

HALF  
DOUBLE  
BLISTER



280  
mm

0-100  
mm

TYPE  
C



|             |        |      |
|-------------|--------|------|
| <b>YATO</b> | L (mm) |      |
| YT-2466     | 280    | 6/24 |



|             |        |      |
|-------------|--------|------|
| <b>YATO</b> | L (mm) |      |
| YT-2468     | 280    | 6/24 |

GB Chain locking pliers  
D Klemmzange mit Kette  
PL Szczypce zaciskowe z łańcuchem  
RUS Клещи давяльные с цепью  
CZ Kleště samosvorné s řetězem  
H Láncos csőfogó  
RO Clește de strângere cu lanț  
E Pinzas de tornillo (de apriete) con cadena

HALF  
DOUBLE  
BLISTER



500  
mm

40 Mn



|             |        |      |
|-------------|--------|------|
| <b>YATO</b> | L (mm) |      |
| YT-2469     | 500    | 6/24 |



GB Self-locking multi grip pliers  
D Grip-Festhaltezeange  
PL Szczypce blacharskie  
RUS Зажим ручной сварочный для закрепления лент и профилей  
CZ Kleště klempířské samodržící  
H Őnzáró rögzítőfogó  
RO Cleste autoblocant pt. tinichigerie  
E Pinzas de chapa

SLIDING CARD



CrMo



200 mm 0-15 mm 70 mm TYPE W

| YATO    | L (mm) |       |
|---------|--------|-------|
| YT-2160 | 200    | 12/24 |



230 mm 0-15 mm 45 mm TYPE JJ

| YATO    | L (mm) |       |
|---------|--------|-------|
| YT-2161 | 230    | 12/24 |



215 mm 0-10 mm 45 mm TYPE LL

| YATO    | L (mm) |       |
|---------|--------|-------|
| YT-2162 | 215    | 12/36 |



210 mm 0-15 mm 25 mm TYPE J

| YATO    | L (mm) |       |
|---------|--------|-------|
| YT-2163 | 210    | 12/36 |



195 mm 0-18 mm 25 mm TYPE L

| YATO    | L (mm) |       |
|---------|--------|-------|
| YT-2164 | 195    | 12/36 |

GB Profile connection pliers  
D Zange zum Verbinden der Profile  
PL Szczypce do łączenia profili  
RUS Щипцы для соединения профилей  
CZ Kleště ke spojování profilů  
H Profilyegesztő fogó  
RO Cleste pt. imbinarea profilelor  
E Pinzas para conectar perfiles

SLIDING CARD

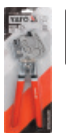

SECTION THICKNESS GRUBOSĆ PROFILU 0,5-0,8 mm



275 mm A380 Al-Ti GR15 BEARING STEEL (PUNCH)

| YATO    | L (mm) |      |
|---------|--------|------|
| YT-5130 | 275    | 6/24 |



345 mm 65 Mn MATERIAL OF PUNCH PUNKTAK

| YATO    | L (mm) |      |
|---------|--------|------|
| YT-5131 | 345    | 6/24 |

GB Profile forming pliers  
D Zange zur Formgebung der Profile  
PL Szczypce do kształtowania profili  
RUS Щипцы для формировки профилей  
CZ Kleště k tvarování profilů  
H Profilformázó fogó  
RO Cleste pt. modelarea profilelor  
E Pinzas para formar perfiles

SLIDING CARD



210 mm



80x35 mm JAWS SZCZEPKI

| YATO    | L (mm) |      |
|---------|--------|------|
| YT-5140 | 210    | 2/12 |



80x35 mm JAWS SZCZEPKI

| YATO    | L (mm) |      |
|---------|--------|------|
| YT-5141 | 210    | 2/12 |



150x35 mm JAWS SZCZEPKI

| YATO    | L (mm) |      |
|---------|--------|------|
| YT-5142 | 210    | 2/12 |

GB Adjustable pliers  
D Verstellbare Kombizange  
PL Szczypce przestawne  
RUS Переставные клещи

CZ Kleště přestavitelné  
H Állítható fogó  
RO Cleste pivot  
E Pinzas ajustables



150 mm  
200 mm  
HRC 45-55

\* - product not for european market  
\* - produkt nieprzeznaczony na rynek europejski



| YATO     | L (mm) | max. working range (mm)<br>max. rozstaw (mm) |      |
|----------|--------|--|------|
| YT-1957  | 150    | 65-70  | 6/60 |
| YT-1958* | 200    | 70-80  | 6/60 |

GB Water pump pliers  
D Wasserpumpenzange  
PL Szczypce nastawne  
RUS Клещи переставные  
CZ Keleště siko

H Vizpumpafagó  
RO Cleste papagal  
E Alicates de fontanero ajustables

250 mm  
300 mm  
CrV



| YATO    | L (mm) |      |
|---------|--------|------|
| YT-2090 | 250    | 6/36 |
| YT-2091 | 300    | 6/36 |

GB Pipe wrench  
D Rohrschlüssel  
PL Klucz do rur

RUS Ключ трубный  
CZ Klíč součásti na trubky

H Csőkulcs  
RO Cheie reglabila pt. tevi  
E Llave para tubos

CrMo

AI



| YATO     | size / rozmiar | max. pipe diameter /<br>max. średnica rury |      |
|----------|----------------|--|------|
| YT-2480* | 10" (250 mm)   | 1" (25 mm)                                 | 6/30 |
| YT-2481  | 12" (300 mm)   | 1.5" (38 mm)                               | 6/18 |
| YT-2482  | 14" (350 mm)   | 2" (50 mm)                                 | 6/12 |
| YT-2483  | 18" (450 mm)   | 2.5" (63 mm)                               | 2/10 |
| YT-2484  | 24" (600 mm)   | 3" (75 mm)                                 | 2/6  |
| YT-2485  | 36" (900 mm)   | 5" (125 mm)                                | 3    |
| YT-2486* | 48" (1200 mm)  | 6" (150 mm)                                | 2    |

\* - product not for european market  
\* - produkt nieprzeznaczony na rynek europejski

GB Pipe wrench  
D Rohrschlüssel  
PL Klucz do rur

RUS Ключ трубный  
CZ Klíč součásti na trubky

H Csőkulcs  
RO Cheie reglabila pt. tevi  
E Llave para tubos

OFFSET TYPE



GB Water pump pliers  
D Wasserpumpenzange  
PL Szczypce nastawne  
RUS Клещи переставные  
CZ Keleště siko

H Vizpumpafagó  
RO Cleste papagal  
E Alicates de fontanero ajustables



250 mm  
NICKEL IRON FINISH



| YATO    | L (mm) |      |
|---------|--------|------|
| YT-2069 | 250    | 6/36 |



| YATO    | L (mm) |      |
|---------|--------|------|
| YT-2070 | 250    | 6/24 |



| YATO     | size / rozmiar | max. pipe diameter /<br>max. średnica rury |      |
|----------|----------------|--|------|
| YT-2487* | 8" (200 mm)    | 3/4" (19 mm)                               | 6/30 |
| YT-2488  | 10" (250 mm)   | 1" (25 mm)                                 | 6/18 |
| YT-2489  | 12" (300 mm)   | 1.5" (38 mm)                               | 6/12 |
| YT-2490  | 14" (350 mm)   | 2" (50 mm)                                 | 2/10 |
| YT-2491  | 18" (450 mm)   | 2.5" (63 mm)                               | 3/6  |
| YT-2492  | 24" (600 mm)   | 3" (75 mm)                                 | 2/4  |
| YT-2493  | 36" (900 mm)   | 5" (125 mm)                                | 1    |
| YT-2494  | 48" (1200 mm)  | 6" (150 mm)                                | 1    |
| YT-2495  | 60" (1500 mm)  | 8" (200 mm)                                | 1    |

GB Pipe wrench  
D Rohrschlüssel  
PL Klucz do rur

RUS Ключ трубный  
CZ Klíč součásti na trubky

H Csőkulcs  
RO Cheie reglabila pt. tevi  
E Llave para tubos

AI HANDLE



| YATO    | size / rozmiar | max. pipe diameter /<br>max. średnica rury |      |
|---------|----------------|--|------|
| YT-2222 | 12" (300 mm)   | 1" (25 mm)                                 | 6/24 |
| YT-2223 | 14" (350 mm)   | 1.5" (38 mm)                               | 4/16 |
| YT-2224 | 18" (450 mm)   | 2" (50 mm)                                 | 3/12 |
| YT-2225 | 24" (600 mm)   | 2.5" (63 mm)                               | 3/6  |

| YATO     | size / rozmiar | max. pipe diameter /<br>max. średnica rury |      |
|----------|----------------|--|------|
| YT-2226* | 10" (250 mm)   | 1.7" (43 mm)                               | 6/24 |

\* - product not for european market  
\* - produkt nieprzeznaczony na rynek europejski

GB Tweezer CZ Pinzeta  
D Pinzette H Csipesz  
PL Pęseta RO Pensetă  
RUS Пинцет E Pinzas

SLIDING  
CARD



302  
STAINLESS  
STEEL  
STAL  
NIEOŻEWNA



ANTI  
MAGNETIC  
ANTYMAG-  
NETYCZNA



ANTIACID  
KWASO-  
ODPORNA



140  
mm HRC  
30

115  
mm HRC  
30



| YATO  | L (mm) |  |
|--|--------|---|
| YT-6903  | 140    | 20/480  |



| YATO  | L (mm) |  |
|--|--------|---|
| YT-6907  | 115    | 20/480  |



180  
mm HRC  
30

170  
mm HRC  
30

| YATO  | L (mm) |  |
|--|--------|---|
| YT-6909  | 180    | 20/480  |



| YATO  | L (mm) |  |
|--|--------|---|
| YT-6910  | 170    | 20/480  |





130  
mm HRC  
40

130  
mm HRC  
40

\* - product not for european market  
\* - produkt nieprzeznaczony na rynek europejski



| YATO  | L (mm) |  |
|--|--------|---|
| YT-6912*   | 130    | 20/480  |



| YATO  | L (mm) |  |
|--|--------|---|
| YT-6913  | 130    | 20/480  |



140  
mm HRC  
40

115  
mm HRC  
40

| YATO  | L (mm) |  |
|--|--------|---|
| YT-6916  | 140    | 20/480  |

| YATO  | L (mm) |  |
|--|--------|---|
| YT-6917  | 115    | 20/480  |







145  
mm HRC  
40

140  
mm HRC  
40

SELF  
CLAMPING  
SAMOZA-  
CIŚKOWA

SELF  
CLAMPING  
SAMOZA-  
CIŚKOWA

| YATO  | L (mm) |  |
|--|--------|---|
| YT-6918  | 145    | 20/480  |

| YATO  | L (mm) |  |
|--|--------|---|
| YT-6920  | 140    | 20/480  |

# 7

## Electrician tools Narzędzia dla elektryków



Crimping pliers & sets  
Szczypcy do zaciskania konektorów i zestawy  
.....134-137



Electrician scissors  
Nożyczki dla elektryków  
.....140



Hydraulic pliers  
Ręczne praski hydrauliczne  
.....137



Cable cutters  
Nożyce do kabli  
.....140



Wire strippers  
Ściągacze izolacji  
.....137-139



Electric meters & voltage testers  
Mierniki elektryczne i próbniki napięcia  
.....141



Cable knives  
Nożyki do kabli  
.....139



Multimeters  
Mierniki  
.....142



Electrical cutters  
Obcinaki elektryczne  
.....140



Electrical insulation tapes & sets  
Taśmy elektroizolacyjne i zestawy  
.....143



- GB Quick interchangeable ratchet crimper set
- D Kabelschuhzange
- PL Zestaw do zaciskania konektorów
- RUS Инструмент для обжима и зачистки проводов
- CZ Kleště pro svěrání zaciskania konektorů
- H Krimpelő fogó
- RO Clește sertizat conectori
- E Pinzas de apretar de conectores



|          |           |  |  |
|----------|-----------|--|--|
| 6<br>PCS | 260<br>mm | 20-10<br>(AWG)<br>0.5-6.0<br>mm² (DIN) | 22-10<br>(AWG)<br>0.5-6.0<br>mm² (DIN) |
| RG<br>6  | RG<br>58  | 20-8<br>(AWG)<br>1.5-10.0<br>mm² (DIN) | 22-12<br>(AWG)<br>0.5-4.0<br>mm² (DIN) |
| RG<br>59 | RG<br>62  |  |  |

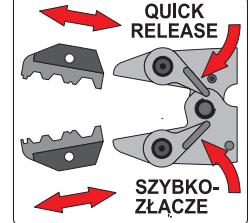

BMC & COLOR SLEEVE

| YATO    | L (mm) |    |
|---------|--------|----|
| YT-2245 | 260    | 10 |

- GB Ratchet crimping pliers
- D Kabelschuhzange
- PL Szczypce do zaciskania konektorów

- RUS Инструмент для обжима и зачистки проводов
- CZ Kleště pro svěrání zaciskania konektorů

- H Krimpelő fogó
- RO Clește sertizat conectori
- E Pinzas de apretar de conectores



7



230 mm

|  |  |
|--|--|
|  | 22-10<br>(AWG)<br>0.5-6.0<br>mm² (DIN) |
|--|--|

| YATO    | L (mm) |      |
|---------|--------|------|
| YT-2296 | 230    | 5/30 |



220 mm

|  |  |
|--|--|
|  | 22-10<br>(AWG)<br>0.5-6.0<br>mm² (DIN) |
|--|--|

| YATO    | L (mm) |      |
|---------|--------|------|
| YT-2246 | 220    | 5/30 |



230 mm

|  |  |
|--|--|
|  | 20-8<br>(AWG)<br>1.5-10.0<br>mm² (DIN) |
|--|--|

| YATO    | L (mm) |      |
|---------|--------|------|
| YT-2297 | 230    | 5/30 |



220 mm

|  |  |
|--|--|
|  | 20-8<br>(AWG)<br>1.5-10.0<br>mm² (DIN) |
|--|--|

| YATO    | L (mm) |      |
|---------|--------|------|
| YT-2247 | 220    | 5/30 |



240 mm

|       |       |
|-------|-------|
| RG 6  | RG 58 |
| RG 59 | RG 62 |

| YATO    | L (mm) |      |
|---------|--------|------|
| YT-2298 | 240    | 5/30 |



220 mm

|       |       |
|-------|-------|
| RG 6  | RG 58 |
| RG 59 | RG 62 |

| YATO    | L (mm) |      |
|---------|--------|------|
| YT-2248 | 220    | 5/30 |



230 mm

|  |  |
|--|--|
|  | 22-12<br>(AWG)<br>0.5-4.0<br>mm² (DIN) |
|--|--|

| YATO    | L (mm) |      |
|---------|--------|------|
| YT-2299 | 230    | 5/30 |



220 mm

|  |  |
|--|--|
|  | 22-12<br>(AWG)<br>0.5-4.0<br>mm² (DIN) |
|--|--|

| YATO    | L (mm) |      |
|---------|--------|------|
| YT-2249 | 220    | 5/30 |

GB Crimping pliers  
D Kabelschuhzange  
PL Szczypce do zaciskania konektorów

RUS Инструмент для обжима  
и зачистки проводов  
CZ Kleště pro svěráni zaciskania konektorů

H Krimpelő fogó  
RO Clește sertizat conectori  
E Pinzas de apretar de conectores



195 mm CAT.5 RJ45 HRC 42-48

195 mm CAT.5 RJ11 RJ12 RJ22 RJ45 HRC 42-48

| YATO    | L (mm) |       |
|---------|--------|-------|
| YT-2242 | 195    | 10/60 |

| YATO    | L (mm) |       |
|---------|--------|-------|
| YT-2244 | 195    | 10/60 |

GB Ratchet crimping pliers  
D Kabelschuhzange  
PL Szczypce do zaciskania konektorów

RUS Инструмент для обжима  
и зачистки проводов  
CZ Kleště pro svěráni zaciskania konektorů

H Krimpelő fogó  
RO Clește sertizat conectori  
E Pinzas de apretar de conectores



230 mm 20-18 (AWG) 0.5-1.0 mm² (DIN) 16-14 (AWG) 1.5-2.5 mm² (DIN) 12-10 (AWG) 4.0-6.0 mm² (DIN)

220 mm 20-18 (AWG) 0.5-1.0 mm² (DIN) 16-14 (AWG) 1.5-2.5 mm² (DIN) 12-10 (AWG) 4.0-6.0 mm² (DIN)

| YATO    | L (mm) |      |
|---------|--------|------|
| YT-2300 | 230    | 5/30 |

| YATO    | L (mm) |      |
|---------|--------|------|
| YT-2250 | 220    | 5/30 |

GB Ratchet crimping pliers  
D Kabelschuhzange  
PL Szczypce do zaciskania konektorów

RUS Инструмент для обжима  
и зачистки проводов  
CZ Kleště pro svěráni zaciskania konektorů

H Krimpelő fogó  
RO Clește sertizat conectori  
E Pinzas de apretar de conectores



220 mm 22-10 (AWG) 0.5-6.0 mm² (DIN)

250 mm 22-10 (AWG) 0.5-6.0 mm² (DIN)

| YATO    | L (mm) |      |
|---------|--------|------|
| YT-2302 | 220    | 5/30 |

| YATO    | L (mm) |      |
|---------|--------|------|
| YT-2251 | 250    | 5/30 |

GB Crimping pliers  
D Kabelschuhzange  
PL Szczypce do zaciskania konektorów  
RUS Инструмент для обжима  
и зачистки проводов

CZ Kleště pro svěráni zaciskania konektorů  
H Krimpelő fogó  
RO Clește sertizat conectori  
E Pinzas de apretar de conectores



180 mm 22-20 (AWG) 0.3-0.5 mm² (DIN) 18-14 (AWG) 1.0-2.0 mm² (DIN) 28-26 (AWG) 0.08-0.12 mm² (DIN) 26-22 (AWG) 0.12-0.3 mm² (DIN) 26-22 (AWG) 0.12-0.3 mm² (DIN)

180 mm 22-20 (AWG) 0.3-0.5 mm² (DIN) 18-14 (AWG) 1.0-2.0 mm² (DIN) 28-26 (AWG) 0.08-0.12 mm² (DIN) 26-22 (AWG) 0.12-0.3 mm² (DIN) 26-22 (AWG) 0.12-0.3 mm² (DIN) 14-10 (AWG) 2.0-6.0 mm² (DIN) 18-16 (AWG) 1.0-1.5 mm² (DIN) 20-22 (AWG) 0.3-0.5 mm² (DIN)

| YATO    | L (mm) |       |
|---------|--------|-------|
| YT-2255 | 180    | 10/60 |

| YATO    | L (mm) |       |
|---------|--------|-------|
| YT-2256 | 180    | 10/60 |

GB Crimping pliers  
D Kabelschuhzange  
PL Szczypce do zaciskania konektorów

RUS Инструмент для обжима  
и зачистки проводов  
CZ Kleště pro svěráni zaciskania konektorů

H Krimpelő fogó  
RO Clește sertizat conectori  
E Pinzas de apretar de conectores

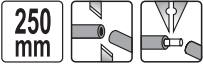

|  |  |  |  |                |
|--|--|--|--|----------------|
| <b>20-10</b><br>(AWG)<br><b>0.5-5.0</b><br>mm <sup>2</sup> (DIN) | <b>20-10</b><br>(AWG)<br><b>0.5-5.0</b><br>mm <sup>2</sup> (DIN) | <b>20-10</b><br>(AWG)<br><b>0.5-5.0</b><br>mm <sup>2</sup> (DIN) | <b>20-10</b><br>(AWG)<br><b>0.5-5.0</b><br>mm <sup>2</sup> (DIN) | <b>M2.6-M5</b> |
|--|--|--|--|----------------|

|             |        |       |
|-------------|--------|-------|
| <b>YATO</b> | L (mm) |       |
| YT-2254     | 250    | 12/48 |

GB Ratchet crimping pliers  
D Kabelschuhzange  
PL Szczypce do zaciskania konektorów

RUS Инструмент для обжима  
и зачистки проводов  
CZ Kleště pro svěráni zaciskania konektorů

H Krimpelő fogó  
RO Clește sertizat conectori  
E Pinzas de apretar de conectores



|                            |                                |
|----------------------------|--------------------------------|
| <b>175</b><br>mm           |                                |
| <b>HRC</b><br><b>44-47</b> | <b>0.2-6.0</b> mm <sup>2</sup> |

|             |        |      |
|-------------|--------|------|
| <b>YATO</b> | L (mm) |      |
| YT-2305     | 175    | 6/36 |



|                            |                                |
|----------------------------|--------------------------------|
| <b>180</b><br>mm           |                                |
| <b>HRC</b><br><b>44-47</b> | <b>0.2-6.0</b> mm <sup>2</sup> |

|             |        |      |
|-------------|--------|------|
| <b>YATO</b> | L (mm) |      |
| YT-2240     | 180    | 6/36 |

GB Crimping pliers  
D Kabelschuhzange  
PL Szczypce do zaciskania konektorów  
RUS Инструмент для обжима и зачистки проводов  
CZ Kleště pro svěráni zaciskania konektorů  
H Krimpelő fogó  
RO Clește sertizat conectori  
E Pinzas de apretar de conectores



|                  |  |                            |             |             |              |            |
|------------------|--|----------------------------|-------------|-------------|--------------|------------|
| <b>200</b><br>mm |  | <b>HRC</b><br><b>42-48</b> | <b>RJ45</b> | <b>RJ11</b> | <b>CAT.5</b> | <b>SK5</b> |
|------------------|--|----------------------------|-------------|-------------|--------------|------------|

|             |        |      |
|-------------|--------|------|
| <b>YATO</b> | L (mm) |      |
| YT-2243     | 200    | 8/48 |

GB Crimping pliers  
D Kabelschuhzange  
PL Szczypce do zaciskania konektorów  
RUS Инструмент для обжима и зачистки проводов  
CZ Kleště pro svěráni zaciskania konektorů  
H Krimpelő fogó  
RO Clește sertizat conectori  
E Pinzas de apretar de conectores



|  |  |
|--|--|
| <b>140</b><br>mm   |  |
| <b>22-10</b><br>(AWG)<br><b>0.2-6.0</b><br>mm <sup>2</sup> (DIN) |  |

|             |        |        |
|-------------|--------|--------|
| <b>YATO</b> | L (mm) |        |
| YT-2271     | 140    | 20/120 |

GB Ratchet crimping pliers  
D Kabelschuhzange  
PL Szczypce do zaciskania konektorów

RUS Инструмент для обжима  
и зачистки проводов  
CZ Kleště pro svěráni zaciskania konektorů

H Krimpelő fogó  
RO Clește sertizat conectori  
E Pinzas de apretar de conectores



|                            |  |
|----------------------------|--|
| <b>195</b><br>mm           |  |
| <b>HRC</b><br><b>44-47</b> | <b>22-14</b><br>(AWG)<br><b>0.5-2.5</b><br>mm <sup>2</sup> (DIN) |

|             |        |      |
|-------------|--------|------|
| <b>YATO</b> | L (mm) |      |
| YT-2307     | 195    | 6/36 |



|                            |  |
|----------------------------|--|
| <b>195</b><br>mm           |  |
| <b>HRC</b><br><b>44-47</b> | <b>22-14</b><br>(AWG)<br><b>0.5-2.5</b><br>mm <sup>2</sup> (DIN) |

|             |        |      |
|-------------|--------|------|
| <b>YATO</b> | L (mm) |      |
| YT-2283     | 195    | 6/36 |



GB Ratchet crimping pliers  
D Kabelschuhzange  
PL Szczypce do zaciskania konektorów  
RUS Инструмент для обжима и зачистки проводов  
CZ Kleště pro svěrání zaciskania konektorů  
H Krimpelő fogó  
RO Clește sertizat conectori  
E Pinzas de apretar de conectores



250 mm  
HRC 44-47  
22-8 (AWG)  
0.5-10.0 mm² (DIN)

|             |        |      |
|-------------|--------|------|
| <b>YATO</b> | L (mm) |      |
| YT-2301     | 250    | 6/36 |



250 mm  
HRC 44-47  
22-8 (AWG)  
0.5-10.0 mm² (DIN)

|             |        |      |
|-------------|--------|------|
| <b>YATO</b> | L (mm) |      |
| YT-2284     | 250    | 6/36 |



230 mm  
CrMo 4140  
HRC 44-48  
22-10 (AWG)  
0.5-6.0 mm² (DIN)

|             |        |      |
|-------------|--------|------|
| <b>YATO</b> | L (mm) |      |
| YT-2285     | 230    | 6/36 |

GB Hydraulic pliers  
D Manuelle Hydraulikpresse  
PL Ręczna praska hydrauliczna  
RUS Ручной гидравлический обжимной инструмент

CZ Ruční hydraulický lis  
H Kézi hydraulikus prés  
RO Presă hidraulică manuală  
E Prensa hidráulica manual



| YATO     | crimping size range / zakres zaciskania (mm) |                | L (mm) | pressure / nacisk (T) | crimping jaws size / rozmiar szczęk zaciskających (mm) |   |
|----------|--|----------------|--------|-----------------------|--|---|
|          | aluminium                                    | copper / miedź |        |                       |  |   |
| YT-22860 | 10-95  | 10-120         | 415    | 8                     | 10; 16; 25; 35; 50; 70; 95; 120                        | 5 |
| YT-22861 | 16-185                                       | 16-240         | 470    | 12                    | 16; 25; 35; 50; 70; 95; 120; 150; 185; 240             | 4 |
| YT-22862 | 16-240                                       | 16-300         | 470    | 18-20                 | 16; 25; 35; 50; 70; 95; 120; 150; 185; 240; 300        | 4 |

GB Universal wire stripper & Ratchet crimping pliers  
D Multifunktion Abisolierzange & Kabelschuhklemmzange  
PL Uniwersalny ściągacz izolacji i szczypce do zaciskania konektorów  
RUS Инструмент для снятия изоляции и зажима проводов  
CZ Univerzální odizolovací klejte & Kleště pro svěrání zaciskania konektorů  
H Blankolo fogo & Krimpelő fogó  
RO Decablator universal & Clește sertizat conectori  
E Extractor de aislado multifunción

|        |           |                                  |                                  |
|--------|-----------|----------------------------------|----------------------------------|
| 205 mm | HRC 52-57 | 24-10 (AWG)<br>0.2-6.0 mm² (DIN) | 22-14 (AWG)<br>0.5-2.5 mm² (DIN) |
|        |           | 22-10 (AWG)<br>1.5-6.0 mm² (DIN) | 12-10 (AWG)<br>4.0-6.0 mm² (DIN) |
|        |           | 7-8 mm                           |                                  |



|             |        |      |
|-------------|--------|------|
| <b>YATO</b> | L (mm) |      |
| YT-2313     | 205    | 5/30 |



|             |        |      |
|-------------|--------|------|
| <b>YATO</b> | L (mm) |      |
| YT-2270     | 205    | 5/30 |

GB Universal wire stripper & Ratchet crimping pliers  
D Multifunktion Abisolierzange & Kabelschuhklemmzange  
PL Uniwersalny ściągacz izolacji i szczypce do zaciskania konektorów  
RUS Инструмент для снятия изоляции и зажима проводов

CZ Univerzální odizolovací klejte & Kleště pro svěrání zaciskania konektorů  
H Blankolo fogo & Krimpelő fogó  
RO Decablator universal & Clește sertizat conectori  
E Extractor de aislado multifunción



|                                  |                                  |  |
|----------------------------------|----------------------------------|--|
| 210 mm                           |                                  |  |
| 22-10 (AWG)<br>0.5-6.0 mm² (DIN) | 24-10 (AWG)<br>0.2-6.0 mm² (DIN) |  |



|             |        |       |
|-------------|--------|-------|
| <b>YATO</b> | L (mm) |       |
| YT-2278     | 210    | 10/60 |

GB Automatic wire stripper  
 D Automatische Abisolierzange  
 PL Automacyjny ściągacz izolacji

RUS Клещи для удаления изоляции  
 CZ Automatický stahovač izolace  
 H Automatikus szigeteléslehúzó

RO Clește automat pt. desizolat  
 E Pelacables automatico

SLIDING CARD



175 mm

10 mm (max)

65Mn  
HRC55



|             |        |       |
|-------------|--------|-------|
| <b>YATO</b> | L (mm) |       |
| YT-2268     | 175    | 10/60 |

195 mm



SK5

20-10 (AWG)  
0.5-6.0 mm<sup>2</sup> (DIN)



|             |        |       |
|-------------|--------|-------|
| <b>YATO</b> | L (mm) |       |
| YT-2275     | 195    | 10/60 |

7

185 mm



SK5

18-12 (AWG)  
1.0-3.2 mm<sup>2</sup> (DIN)



|             |        |      |
|-------------|--------|------|
| <b>YATO</b> | L (mm) |      |
| YT-2316     | 185    | 8/48 |

170 mm



SK5

18-12 (AWG)  
1.0-3.2 mm<sup>2</sup> (DIN)



|             |        |      |
|-------------|--------|------|
| <b>YATO</b> | L (mm) |      |
| YT-2276     | 170    | 8/48 |

GB Wire stripper  
 D Abisolierzange

PL Ściągacz izolacji  
 RUS Съёмник изоляции

CZ Odizolovací klejte  
 H Blankolo fogó

RO Decablator  
 E Extractor de aislado



240 mm

HRC 46-50

22-10 (AWG)  
1.5-6.0 mm<sup>2</sup> (DIN)

22-10 (AWG)  
1.5-6.0 mm<sup>2</sup> (DIN)

22-10 (AWG)  
0.75-6.0 mm<sup>2</sup> (DIN)



|             |        |       |
|-------------|--------|-------|
| <b>YATO</b> | L (mm) |       |
| YT-22930    | 240    | 12/48 |

205 mm

HRC 50-53

RG 6

22-10 (AWG)  
0.64-2.6 mm<sup>2</sup> (DIN)

22-10 (AWG)  
0.64-2.6 mm<sup>2</sup> (DIN)

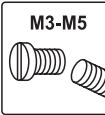

|             |        |             |    |
|-------------|--------|-------------|----|
| <b>YATO</b> | L (mm) | PCS packing |    |
| YT-2292     | 205    | 12          | 72 |

215 mm

HRC 50-53

RG 6

18-10 (AWG)  
1.0-2.5 mm<sup>2</sup> (DIN)

7-8 (mm)

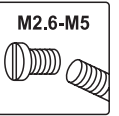

|             |        |             |    |
|-------------|--------|-------------|----|
| <b>YATO</b> | L (mm) | PCS packing |    |
| YT-2293     | 215    | 12          | 72 |

220 mm

HRC 50-53

7 (mm)

22-10 (AWG)  
0.64-2.6 mm<sup>2</sup> (DIN)

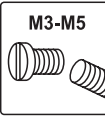

|             |        |             |    |
|-------------|--------|-------------|----|
| <b>YATO</b> | L (mm) | PCS packing |    |
| YT-2295     | 220    | 12          | 72 |

GB Wire stripper  
 D Abisolierzange  
 PL Ściągacz izolacji

RUS Съёмник изоляции  
 CZ Odizolovací klejte  
 H Blankolo fogó

RO Decablator  
 E Extractor de aislado

SLIDING CARD



210 mm



# 310  
# 311  
# 410  
# 411

RG 6



20-8 (AWG)  
0.5-6.0 mm<sup>2</sup> (DIN)

22-10 (AWG)  
0.5-6.0 mm<sup>2</sup> (DIN)

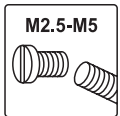

|             |        |       |
|-------------|--------|-------|
| <b>YATO</b> | L (mm) |       |
| YT-2277     | 210    | 10/60 |

GB Wire stripper  
D Abisolierzange  
PL Ściągacz izolacji  
RUS Съёмник изоляции

CZ Odizolovací klejste  
H Blankolo fogo  
RO Decablator  
E Extractor de aislado

SLIDING CARD

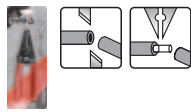

30-16  
(AWG)  
0.25-1.3  
mm (DIN) 160 mm HRC 48-52

| YATO    | L (mm) | PCS packing |
|---------|--------|-------------|
| YT-2266 | 160    | 10/60       |

GB Wire stripper  
D Abisolierzange  
PL Ściągacz izolacji  
RUS Съёмник изоляции

CZ Odizolovací klejste  
H Blankolo fogo  
RO Decablator  
E Extractor de aislado

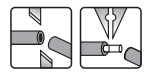

22-10  
(AWG)  
0.64-2.6  
mm<sup>2</sup> (DIN) 165 mm HRC 50-53

| YATO    | L (mm) | PCS packing |
|---------|--------|-------------|
| YT-2294 | 165    | 12 120      |



SLIDING CARD

12 PCS

COLOR BOX



20-10  
(AWG)  
0.8-2.6  
mm (DIN) 160 mm HRC 48-52

| YATO    | L (mm) | PCS packing |
|---------|--------|-------------|
| YT-2319 | 160    | 10/60       |



20-10  
(AWG)  
0.8-2.6  
mm (DIN) M3-M4 180 mm HRC 45-49

| YATO    | L (mm) | PCS packing |
|---------|--------|-------------|
| YT-2273 | 180    | 10/60       |

SLIDING CARD



20-10  
(AWG)  
0.8-2.6  
mm (DIN) 160 mm HRC 48-52

| YATO    | L (mm) | PCS packing |
|---------|--------|-------------|
| YT-2267 | 160    | 10/60       |



22-10  
(AWG)  
0.64-2.6  
mm<sup>2</sup> (DIN) M4-M5 185 mm HRC 50-53

| YATO    | L (mm) | PCS packing |
|---------|--------|-------------|
| YT-2290 | 185    | 12 120      |



SLIDING CARD

12 PCS

COLOR BOX



GB Cable cutter  
D Kabelschere  
PL Szczytce do cięcia przewodów  
RUS Кабелерезы

CZ Elektrické upichováky  
H Kábelvágó  
RO Patent tăietor pt. electrice  
E Tijeras para cables

SLIDING CARD



3.5 mm 170 mm 10.5 mm (max) SK5

| YATO    | L (mm) | PCS packing |
|---------|--------|-------------|
| YT-2279 | 170    | 10/60       |

GB Wire stripper  
D Abisolierzange  
PL Ściągacz izolacji  
RUS Съёмник изоляции  
CZ Odizolovací klejste

H Blankolo fogo  
RO Decablator  
E Extractor de aislado

SLIDING CARD



22-10  
(AWG)  
0.34-6.0  
mm<sup>2</sup> (DIN) 140 mm

| YATO    | L (mm) | PCS packing |
|---------|--------|-------------|
| YT-2272 | 140    | 20/120      |

GB Wire stripper  
D Abisolierzange  
PL Ściągacz izolacji

RUS Съёмник изоляции  
CZ Odizolovací klejste  
H Blankolo fogo  
RO Decablator  
E Extractor de aislado

125 mm 8-13 mm SK5 20-10 (AWG) 0.5-6.0 mm<sup>2</sup> (DIN) RG 6 RG 59



SLIDING CARD

| YATO    | L (mm) | PCS packing |
|---------|--------|-------------|
| YT-2274 | 125    | 15/90       |

GB Cable stripper  
D Kabelmesser  
PL Nożyk do kabli

RUS Нож кабельный  
CZ Nůž na kabele  
H Kábelkés

RO Cuțitaș pt. cabluri  
E Cuchillo

8-28 mm



SLIDING CARD

| YATO    | L (mm) | PCS packing |
|---------|--------|-------------|
| YT-2280 | 190    | 10/100      |

GB Electrical cutter  
D Seitenschneider  
PL Obcinak elektryczny  
RUS Инструмент для обрезки проводов  
CZ Elektrické upichováky  
H Kábelvágó

RO Clește tăietor - electrician  
E Cortacables eléctricos

SLIDING CARD



125 mm

20-18 (AWG)  
0.5-1.5 mm<sup>2</sup> (DIN)

|             |        |        |
|-------------|--------|--------|
| <b>YATO</b> | L (mm) |        |
| YT-2260     | 125    | 15/150 |

125 mm

|             |        |        |
|-------------|--------|--------|
| <b>YATO</b> | L (mm) |        |
| YT-2261     | 125    | 15/150 |



125 mm

3.0 mm<sup>2</sup> (max)

STAINLESS STEEL STAL NERZEWA

|             |        |        |
|-------------|--------|--------|
| <b>YATO</b> | L (mm) |        |
| YT-2262     | 125    | 20/120 |

GB Electrical cutter  
D Seitenschneider  
PL Obcinak elektryczny  
RUS Инструмент для обрезки проводов  
CZ Elektrické upichováky  
H Kábelvágó  
RO Clește tăietor - electrician  
E Cortacables eléctricos

SLIDING CARD 12 PCS COLOR BOX



130 mm

HRC 55-57

|             |        |             |     |
|-------------|--------|-------------|-----|
| <b>YATO</b> | L (mm) | PCS packing |     |
| YT-2263     | 130    | 12          | 120 |



130 mm

HRC 55-57

|             |        |             |     |
|-------------|--------|-------------|-----|
| <b>YATO</b> | L (mm) | PCS packing |     |
| YT-2264     | 130    | 12          | 120 |

GB Electrician scissors  
D Elektrische Schere  
PL Nożyczki dla elektryków  
RUS Ножницы универсальные  
CZ Elektrické nůžky

H Univerzális olló  
RO Foarfece - electrician  
E Tijeras eléctricos

140 mm

STAINLESS STEEL STAL NERZEWA

HRC 52-56



SLIDING CARD



|             |        |        |
|-------------|--------|--------|
| <b>YATO</b> | L (mm) |        |
| YT-1974     | 140    | 12/120 |

GB Ratchet cable cutter  
D Ratschenkabelschneider  
PL Nożyce zapadkowe do kabli  
RUS Кабелерез секторный  
CZ Kleště na kabely, rohatka se západkou

H Racsnis kábelvágó  
RO Clește pt. taiat cablu cu clichet  
E Cortacables de carraca

COLOR BOX



Cu/Al CABLE KABEL

60Si2Mn

HRC 50 CUTTING BLADE OSTRZE TNACE

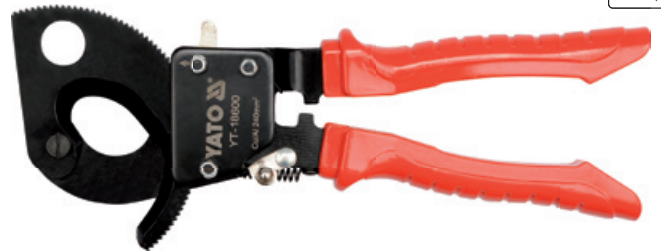

|             |   |        |    |
|-------------|---|--------|----|
| <b>YATO</b> | cutting range / max. przekrój cięcia (mm <sup>2</sup> ) | L (mm) |    |
| YT-18600    | 240   | 300    | 10 |



|             |   |        |    |
|-------------|---|--------|----|
| <b>YATO</b> | cutting range / max. przekrój cięcia (mm <sup>2</sup> ) | L (mm) |    |
| YT-18602    | 380   | 380    | 10 |

GB Cable cutter  
D Kabelschere  
PL Nożyce do kabli  
RUS Кабелерезы  
CZ Elektrické upichováky

H Kábelvágó  
RO Patent tăietor pt. electricie  
E Tijeras para cables

COLOR BOX



STEEL STAL



|             |   |        |    |
|-------------|---|--------|----|
| <b>YATO</b> | cutting range / max. przekrój cięcia (mm <sup>2</sup> ) | L (mm) |    |
| YT-18610    | 125   | 370    | 20 |
| YT-18611    | 250   | 580    | 10 |
| YT-18612    | 500   | 770    | 5  |

GB Voltage tester  
D Spannungsprüfer  
PL Próbnik napięcia  
RUS Отвёртка с передачей

CZ Zkoušeč napětí  
H Fáziskereső  
RO Creion de tensiune  
E Comprobador de corriente

PLASTIC  
HANGER



125-250  
V~



| YATO    | ⊖ | L (mm) | ☐      |
|---------|---|--------|--------|
| YT-2830 | 4 | 190    | 12/144 |

GB Digital voltage tester  
D Spannungsprüfer  
PL Uniwersalny tester elektryczny  
RUS Отвёртка с передачей

CZ Zkoušeč napětí  
H Fáziskereső  
RO Creion de tensiune  
E Comprobador de corriente

SLIDING  
CARD



1.5-9 V  
50-500 Hz

70-250 V

70-600 V

POWER  
ZASILANE  
2x1.5 V  
LR41  
BATTERY\*

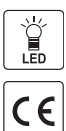

| YATO    | ☐     |
|---------|-------|
| YT-2864 | 6/120 |

GB Digital voltage tester  
D Spannungsprüfer  
PL Uniwersalny tester elektryczny  
RUS Отвёртка с передачей

CZ Zkoušeč napětí  
H Fáziskereső  
RO Creion de tensiune  
E Comprobador de corriente

SLIDING  
CARD



1.5-9 V  
50-500 Hz

70-250 V

70-1000 V

POWER  
ZASILANE  
2x1.5 V  
LR44  
BATTERY\*

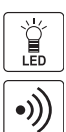

| YATO     | ☐     |
|----------|-------|
| YT-28631 | 6/120 |

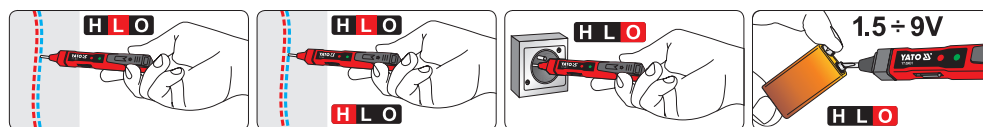

GB Digital voltage tester  
D Digitaler-Spannungsprüfer  
PL Wskaźnik elektryczny  
RUS Тестер напряжения цифровой

CZ Zkoušečka napětí digitální  
H Digitális voltmérő  
RO Tester digital pt. tensiune electrica  
E Indicador eléctrico

SLIDING  
CARD



12-250  
V~

50-500  
Hz

LCD  
DISPLAY

NO BATTERY  
NEEDED  
SE POTREBNA  
BATERII



| YATO    | ☐      |
|---------|--------|
| YT-2861 | 20/500 |



| YATO    | ☐      |
|---------|--------|
| YT-2862 | 20/500 |



| YATO    | ☐     |
|---------|-------|
| YT-2863 | 6/120 |

GB Digital universal multimeter  
 D Universell digital Messgerät  
 PL Cyfrowy miernik uniwersalny  
 RUС Универсальный цифровой измеритель  
 CZ Digitální multimetr univerzální  
 H Digitális multiméter  
 RO Multimetru digital universal  
 E Manómetro digital universal

|                  |                  |                               |
|------------------|------------------|-------------------------------|
| U<br>0-500<br>~V | U<br>0-500<br>~V | I<br>0-5<br>~A                |
| R<br>0-2<br>MΩ   |                  | h <sub>FE</sub><br>PNP<br>NPN |
|                  |                  |                               |



COLOR BOX

|                   |                               |                      |                 |                 |                 |
|-------------------|-------------------------------|----------------------|-----------------|-----------------|-----------------|
| U<br>0-1000<br>~V | U<br>0-750<br>~V              | I<br>0-10<br>~A      | I<br>0-10<br>~A | R<br>0-20<br>MΩ | C<br>0-20<br>μF |
|                   | h <sub>FE</sub><br>PNP<br>NPN | AUTO<br>POWER<br>OFF |                 |                 |                 |



COLOR BOX

|                       |                  |                               |                                 |                      |                   |
|-----------------------|------------------|-------------------------------|---------------------------------|----------------------|-------------------|
| U<br>0-600<br>~V      | U<br>0-600<br>~V | I<br>0-10<br>~A               | I<br>0-10<br>~A                 | R<br>0-20<br>MΩ      | C<br>0-1000<br>μF |
| T<br>-20°+<br>+1000°C |                  | h <sub>FE</sub><br>PNP<br>NPN | AUTO<br>RANGE<br>AUTO<br>ZAKRES | AUTO<br>POWER<br>OFF |                   |
|                       |                  |                               |                                 |                      |                   |



COLOR BOX

7

**YATO**  
 YT-73080 50

**YATO**  
 YT-73082 30

**YATO**  
 YT-73084 44

|                  |                  |                  |                       |                 |                                 |
|------------------|------------------|------------------|-----------------------|-----------------|---------------------------------|
|                  | U<br>0-600<br>~V | U<br>0-600<br>~V | I<br>0-10<br>~A       | I<br>0-10<br>~A | R<br>0-40<br>MΩ                 |
| C<br>0-100<br>μF | f<br>100<br>kHz  |                  | T<br>-20°+<br>+1000°C |                 | AUTO<br>RANGE<br>AUTO<br>ZAKRES |
|                  |                  |                  | AUTO<br>POWER<br>OFF  |                 |                                 |



NYLON CASE & COLOR BOX

|                  |                  |                                 |                       |                 |                    |
|------------------|------------------|---------------------------------|-----------------------|-----------------|--------------------|
| 5 in 1<br>5 w 1  | U<br>0-600<br>~V | U<br>0-600<br>~V                | I<br>0-10<br>~A       | I<br>0-10<br>~A | R<br>0-40<br>MΩ    |
| C<br>0-100<br>μF | f<br>200<br>kHz  |                                 | T<br>-20°+<br>+1000°C |                 | %RH<br>30%+<br>90% |
|                  |                  | AUTO<br>RANGE<br>AUTO<br>ZAKRES | AUTO<br>POWER<br>OFF  |                 |                    |



NYLON CASE & COLOR BOX

|                   |                   |                  |                       |                 |                                 |
|-------------------|-------------------|------------------|-----------------------|-----------------|---------------------------------|
| TRUE<br>RMS       | U<br>0-600<br>~V  | U<br>0-600<br>~V | I<br>0-10<br>~A       | I<br>0-10<br>~A | R<br>0-60<br>MΩ                 |
| C<br>0-4000<br>μF | f<br>9.999<br>MHz |                  | T<br>-20°+<br>+1000°C |                 | AUTO<br>RANGE<br>AUTO<br>ZAKRES |
|                   |                   |                  | AUTO<br>POWER<br>OFF  |                 | USB                             |



COLOR BOX

**YATO**  
 YT-73086 24

**YATO**  
 YT-73087 24

**YATO**  
 YT-73088 20



|                       |                  |                                 |                      |
|-----------------------|------------------|---------------------------------|----------------------|
| U<br>0-600<br>~V      | U<br>0-600<br>~V | I<br>0-600<br>~A                | R<br>0-200<br>MΩ     |
| T<br>-20°+<br>+1000°C |                  | AUTO<br>RANGE<br>AUTO<br>ZAKRES | AUTO<br>POWER<br>OFF |
|                       |                  |                                 |                      |

NYLON CASE & COLOR BOX



**YATO**  
 YT-73091 20

PAPER CARD  
& SHRINK



GB Insulation tape  
D Isolierband  
PL Taśma elektroizolacyjna

RUS Изолянта  
CZ Izolační páska  
H Szigetelőszalag

RO Banda izolatoare  
E Cinta aislante



EN60454-3-1-1/F-PVC/60/R-Tp  
12 mm x 10 m x 0.13 mm  
DIELECTRIC STRENGTH / WYTRZYMAŁOŚĆ DIELEKTRYCZNA > 40 Kv / mm  
ELONGATION / WYDŁUŻENIE > 125%  
FLAME TEST / TEST OGNIOWY < 1 s  
STORE TEMPERATURE / TEMPERATURA SKŁADOWANIA +10°C ~ +40°C  
USING TEMPERATURE / TEMPERATURA UŻYTKOWANIA +5°C ~ +50°C

|             |        |
|-------------|--------|
| <b>YATO</b> |        |
| YT-8152     | 96/384 |



EN60454-3-1-1/F-PVC/60/R-Tp  
19 mm x 20 m x 0.13 mm  
DIELECTRIC STRENGTH / WYTRZYMAŁOŚĆ DIELEKTRYCZNA > 40 Kv / mm  
ELONGATION / WYDŁUŻENIE > 125%  
FLAME TEST / TEST OGNIOWY < 1 s  
STORE TEMPERATURE / TEMPERATURA SKŁADOWANIA +10°C ~ +40°C  
USING TEMPERATURE / TEMPERATURA UŻYTKOWANIA +5°C ~ +50°C

|             |        |
|-------------|--------|
| <b>YATO</b> |        |
| YT-8166     | 72/288 |



10  
PCS

EN60454-3-1-1/F-PVC/60/R-Tp  
12 mm x 10 m x 0.13 mm  
DIELECTRIC STRENGTH / WYTRZYMAŁOŚĆ DIELEKTRYCZNA > 40 Kv / mm  
ELONGATION / WYDŁUŻENIE > 125%  
FLAME TEST / TEST OGNIOWY < 1 s  
STORE TEMPERATURE / TEMPERATURA SKŁADOWANIA +10°C ~ +40°C  
USING TEMPERATURE / TEMPERATURA UŻYTKOWANIA +5°C ~ +50°C

|             |       |
|-------------|-------|
| <b>YATO</b> |       |
| YT-8156     | 10/40 |



10  
PCS

EN60454-3-1-1/F-PVC/60/R-Tp  
19 mm x 20 m x 0.13 mm  
DIELECTRIC STRENGTH / WYTRZYMAŁOŚĆ DIELEKTRYCZNA > 40 Kv / mm  
ELONGATION / WYDŁUŻENIE > 125%  
FLAME TEST / TEST OGNIOWY < 1 s  
STORE TEMPERATURE / TEMPERATURA SKŁADOWANIA +10°C ~ +40°C  
USING TEMPERATURE / TEMPERATURA UŻYTKOWANIA +5°C ~ +50°C

|             |      |
|-------------|------|
| <b>YATO</b> |      |
| YT-8173     | 6/24 |



EN60454-3-1-1/F-PVC/60/R-Tp  
15 mm x 20 m x 0.13 mm  
DIELECTRIC STRENGTH / WYTRZYMAŁOŚĆ DIELEKTRYCZNA > 40 Kv / mm  
ELONGATION / WYDŁUŻENIE > 125%  
FLAME TEST / TEST OGNIOWY < 1 s  
STORE TEMPERATURE / TEMPERATURA SKŁADOWANIA +10°C ~ +40°C  
USING TEMPERATURE / TEMPERATURA UŻYTKOWANIA +5°C ~ +50°C

|             |        |
|-------------|--------|
| <b>YATO</b> |        |
| YT-8159     | 72/288 |



EN60454-3-1-1/F-PVC/60/R-Tp  
25 mm x 20 m x 0.19 mm  
DIELECTRIC STRENGTH / WYTRZYMAŁOŚĆ DIELEKTRYCZNA > 80 Kv / mm  
ELONGATION / WYDŁUŻENIE > 125%  
FLAME TEST / TEST OGNIOWY < 1 s  
STORE TEMPERATURE / TEMPERATURA SKŁADOWANIA +10°C ~ +40°C  
USING TEMPERATURE / TEMPERATURA UŻYTKOWANIA +5°C ~ +50°C

|             |        |
|-------------|--------|
| <b>YATO</b> |        |
| YT-8174     | 48/192 |



EN60454-3-1-1/F-PVC/60/R-Tp  
19 mm x 20 m x 0.13 mm  
DIELECTRIC STRENGTH / WYTRZYMAŁOŚĆ DIELEKTRYCZNA > 40 Kv / mm  
ELONGATION / WYDŁUŻENIE > 125%  
FLAME TEST / TEST OGNIOWY < 1 s  
STORE TEMPERATURE / TEMPERATURA SKŁADOWANIA +10°C ~ +40°C  
USING TEMPERATURE / TEMPERATURA UŻYTKOWANIA +5°C ~ +50°C

|             |        |
|-------------|--------|
| <b>YATO</b> |        |
| YT-8165     | 72/288 |



EN60454-3-1-1/F-PVC/60/R-Tp  
50 mm x 33 m x 0.19 mm  
DIELECTRIC STRENGTH / WYTRZYMAŁOŚĆ DIELEKTRYCZNA > 80 Kv / mm  
ELONGATION / WYDŁUŻENIE > 125%  
FLAME TEST / TEST OGNIOWY < 1 s  
STORE TEMPERATURE / TEMPERATURA SKŁADOWANIA +10°C ~ +40°C  
USING TEMPERATURE / TEMPERATURA UŻYTKOWANIA +5°C ~ +50°C

|             |    |
|-------------|----|
| <b>YATO</b> |    |
| YT-8177     | 48 |

# 8

**Hammers, chisels,  
punches & axes**  
**Młotki, dłuta,  
przecinaki i siekiery**

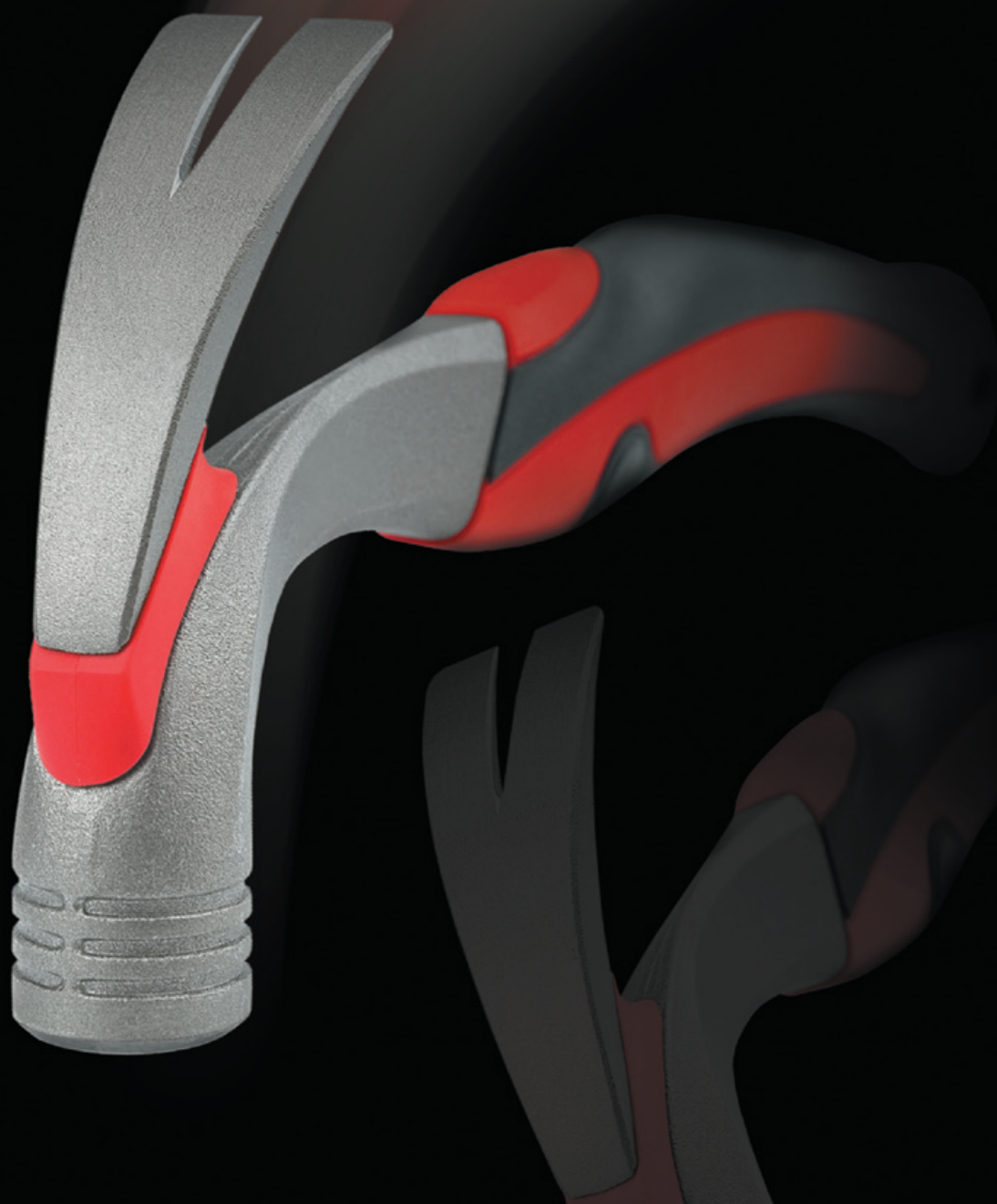



|  |   |     |
|--|---|-----|
| Machinist hammers<br>Młotki ślusarskie |  | 146 |
|--|---|-----|

|  |   |     |
|--|---|-----|
| Dead blow hammers<br>Młotki bezodrzutowe |  | 148 |
|--|---|-----|

|   |   |     |
|---|---|-----|
| Stoning hammers<br>Młotki kamieniarskie |  | 146 |
|---|---|-----|

|  |   |     |
|--|---|-----|
| Ball pein hammers & sets<br>Młotki blacharskie i zestawy |  | 149 |
|--|---|-----|

|   |   |     |
|---|---|-----|
| Hammers with tubular steel handle<br>Młotki z trzonkiem rurowym |  | 147 |
|---|---|-----|

|                                 |   |     |
|---------------------------------|---|-----|
| Claw hammers<br>Młotki szewskie |  | 149 |
|---------------------------------|---|-----|

|   |     |
|---|-----|
| Claw hammers<br>Młotki szewskie.....            | 147 |
| Roofing hammers<br>Młotki ciesielskie.....      | 147 |
| Mason's hammers<br>Młotki murarskie.....        | 147 |
| Plasterer's hatchets<br>Toporki tynkarskie..... | 147 |

|   |   |         |
|---|---|---------|
| Chisels, cold chisels & punches<br>Dłuta, przecinaki i przebijaki |  | 150-152 |
|---|---|---------|

|   |   |     |
|---|---|-----|
| Fully drop forged hammers<br>Młotki monolityczne kute |  | 147 |
|---|---|-----|

|  |     |
|--|-----|
| Wood chisels & sets<br>Dłuta stolarskie i zestawy.....           | 150 |
| Cold chisels<br>Przecinaki.....                                  | 150 |
| Punches<br>Przebijaki.....                                       | 150 |
| Pin punches<br>Wybijaki.....                                     | 151 |
| Punches<br>Punktaki.....   | 151 |
| Cold chisel & punch sets<br>Zestawy przecinaków i punktaków..... | 151 |

|   |     |
|---|-----|
| Claw hammers<br>Młotki szewskie.....            | 147 |
| Roofing hammers<br>Młotki ciesielskie.....      | 147 |
| Mason's hammers<br>Młotki murarskie.....        | 147 |
| Plasterer's hatchets<br>Toporki tynkarskie..... | 147 |

|                       |   |     |
|-----------------------|---|-----|
| Wrecking bars<br>Łomy |  | 153 |
|-----------------------|---|-----|

|                                 |   |     |
|---------------------------------|---|-----|
| Rubber mallets<br>Młotki gumowe |  | 148 |
|---------------------------------|---|-----|

|                  |   |     |
|------------------|---|-----|
| Axes<br>Siekiery |  | 153 |
|------------------|---|-----|

GB Machinist hammer    RUS Молоток слесарный    RO Ciocan de lăcătușerie  
 D Schlosserhammer    CZ Zámečnické kladívko    E Martillo  
 PL Młotek ślusarski    H Vaskalapács

DIN  
1041



| YATO    | m (g) | L (mm) | A (mm) | H (mm) |        |
|---------|-------|--------|--------|--------|--------|
| YT-4491 | 100   | 260    | 15     | 80     | 12/120 |
| YT-4492 | 200   | 280    | 20     | 93     | 6/60   |
| YT-4493 | 300   | 300    | 21     | 103    | 6/60   |
| YT-4494 | 400   | 310    | 23     | 111    | 6/48   |
| YT-4495 | 500   | 320    | 26     | 118    | 6/36   |

| YATO    | m (g) | L (mm) | A (mm) | H (mm) |      |
|---------|-------|--------|--------|--------|------|
| YT-4496 | 600   | 330    | 28     | 119    | 6/36 |
| YT-4497 | 800   | 350    | 31     | 125    | 6/24 |
| YT-4498 | 1000  | 360    | 35     | 132    | 6/24 |
| YT-4499 | 1500  | 380    | 40     | 143    | 6/12 |
| YT-4500 | 2000  | 400    | 45     | 153    | 6/12 |

8



| YATO    | m (g) | L (mm) | A (mm) | H (mm) |        |
|---------|-------|--------|--------|--------|--------|
| YT-4501 | 100   | 260    | 15     | 82     | 12/120 |
| YT-4502 | 200   | 280    | 19     | 95     | 6/60   |
| YT-4503 | 300   | 300    | 23     | 105    | 6/60   |
| YT-4504 | 400   | 310    | 25     | 112    | 6/48   |
| YT-4505 | 500   | 320    | 27     | 118    | 6/36   |

| YATO    | m (g) | L (mm) | A (mm) | H (mm) |      |
|---------|-------|--------|--------|--------|------|
| YT-4506 | 600   | 330    | 29     | 122    | 6/36 |
| YT-4507 | 800   | 350    | 33     | 135    | 6/24 |
| YT-4508 | 1000  | 360    | 36     | 135    | 6/24 |
| YT-4509 | 1500  | 380    | 42     | 145    | 6/12 |
| YT-4510 | 2000  | 400    | 47     | 155    | 6/12 |

GB Safety stoning hammer    RUS Молоток каменщика    RO Ciocan pt. zidarie  
 D Faustel    CZ Palička kovová    E Martillo  
 PL Młotek kamieniarski    H Kőtörő kalapács

DIN  
6475



| YATO    | m (g) | L (mm) | A (mm) | H (mm) |      |
|---------|-------|--------|--------|--------|------|
| YT-4550 | 1000  | 260    | 40     | 95     | 6/24 |
| YT-4551 | 1250  | 260    | 43     | 100    | 6/24 |

| YATO    | m (g) | L (mm) | A (mm) | H (mm) |      |
|---------|-------|--------|--------|--------|------|
| YT-4552 | 1500  | 280    | 45     | 110    | 6/12 |
| YT-4553 | 2000  | 300    | 50     | 120    | 6/12 |

GB Claw hammer  
D Schusterhammer  
PL Młotek szewski  
RUS Молоток гвоздодёр  
CZ Ševcovské kladívko  
H Cipész kalapács  
RO Ciocan de cizmărie  
E Martillo sacador



- high quality steel handle
- forged carbon steel head hardened and tempered
- stalowa rączka
- główka ze stali węglowej, kuta, ulepszona cieplnie

| YATO    | m (g) | L (mm) | A (mm) | H (mm) |      |
|---------|-------|--------|--------|--------|------|
| YT-4560 | 450   | 318    | 30     | 130    | 6/24 |

GB Roofing hammer  
D Latthammer  
Geschmiedet  
PL Młotek ciesielski  
RUS Молоток жестящика  
CZ Tesařské kladívko  
H Ácskalapács  
RO Ciocan de dulgherie  
E Martillo techumbre



- high quality steel handle
- forged carbon steel head hardened and tempered
- stalowa rączka
- główka ze stali węglowej, kuta, ulepszona cieplnie

| YATO    | m (g) | L (mm) | A (mm) | H (mm) |      |
|---------|-------|--------|--------|--------|------|
| YT-4561 | 600   | 318    | 25x25  | 165    | 6/24 |

GB Mason's hammer, type B  
D Berliner Mauerhammer  
PL Młotek murarski berliński  
RUS Молоток каменщика широкий  
CZ Zednické kladívko berlinské



- high quality steel handle
- forged carbon steel head hardened and tempered
- stalowa rączka
- główka ze stali węglowej, kuta, ulepszona cieplnie

| YATO    | m (g) | L (mm) | A (mm) | H (mm) |      |
|---------|-------|--------|--------|--------|------|
| YT-4562 | 600   | 315    | 24x23  | 200    | 6/24 |

GB Mason's hammer, type R  
D Mauerhammer Rheinische Form  
PL Młotek murarski reński  
RUS Молоток каменщика узкий  
CZ Zednické kladívko renské



- high quality steel handle
- forged carbon steel head hardened and tempered
- stalowa rączka
- główka ze stali węglowej, kuta, ulepszona cieplnie

| YATO    | m (g) | L (mm) | A (mm) | H (mm) |      |
|---------|-------|--------|--------|--------|------|
| YT-4563 | 600   | 315    | 23x23  | 170    | 6/24 |

GB Plasterer's hatchet  
D Gipserbeil  
PL Toporek tynkarski  
RUS Топор штукатурный  
CZ Omítací sekýrka  
H Kőműves szekerce  
RO Toporaş de tencuit  
E Hacha enlucido



- high quality steel handle
- forged carbon steel head hardened and tempered
- stalowa rączka
- główka ze stali węglowej, kuta, ulepszona cieplnie

| YATO    | m (g) | L (mm) | A (mm) | H (mm) |      |
|---------|-------|--------|--------|--------|------|
| YT-4564 | 600   | 315    | 25x20  | 175    | 6/24 |

GB Claw hammer  
D Schusterhammer  
PL Młotek szewski  
RUS Молоток гвоздодёр  
CZ Ševcovské kladívko  
H Cipész kalapács  
RO Ciocan de cizmărie  
E Martillo sacador



- high quality steel handle
- forged carbon steel head hardened and tempered
- stalowa rączka
- główka ze stali węglowej, kuta, ulepszona cieplnie

| YATO    | m (g) | L (mm) | A (mm) | H (mm) |      |
|---------|-------|--------|--------|--------|------|
| YT-4570 | 450   | 315    | 30     | 130    | 6/24 |

GB Roofing hammer  
D Latthammer  
Geschmiedet  
PL Młotek ciesielski  
RUS Молоток жестящика



- high quality steel handle
- forged carbon steel head hardened and tempered
- stalowa rączka
- główka ze stali węglowej, kuta, ulepszona cieplnie

| YATO    | m (g) | L (mm) | A (mm) | H (mm) |      |
|---------|-------|--------|--------|--------|------|
| YT-4571 | 600   | 331    | 25x25  | 165    | 6/24 |

GB Mason's hammer, type R  
D Mauerhammer Rheinische Form  
PL Młotek murarski reński  
RUS Молоток каменщика узкий  
CZ Zednické kladívko renské



- high quality steel handle
- forged carbon steel head hardened and tempered
- stalowa rączka
- główka ze stali węglowej, kuta, ulepszona cieplnie

| YATO    | m (g) | L (mm) | A (mm) | H (mm) |      |
|---------|-------|--------|--------|--------|------|
| YT-4573 | 600   | 382    | 25x24  | 158    | 6/24 |

GB Plasterer's hatchet  
D Gipserbeil  
PL Toporek tynkarski  
RUS Топор штукатурный  
CZ Omítací sekýrka  
H Kőműves szekerce  
RO Toporaş de tencuit  
E Hacha enlucido

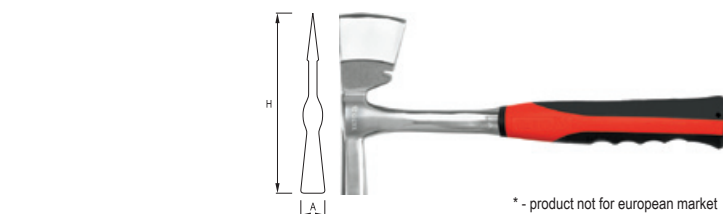

- high quality steel handle
- forged carbon steel head hardened and tempered
- stalowa rączka
- główka ze stali węglowej, kuta, ulepszona cieplnie

\* - product not for european market  
\* - produkt nieprzeznaczony na rynek europejski

| YATO     | m (g) | L (mm) | A (mm) | H (mm) |      |
|----------|-------|--------|--------|--------|------|
| YT-4574* | 600   | 315    | 45x22  | 117    | 6/24 |

GB Rubber mallet with fibreglass, TPR handle  
 D Gummihammer mit Fibreglasstiel  
 PL Młotek gumowy z trzonkiem z włókna szklanego  
 RUS Киянка резиновая со стеклопластиковой ручкой

CZ Pryžové kladívko  
 H Gumikalapács  
 RO Ciocan de cauciuc  
 E Mazo de goma



| YATO    | m (g) | L (mm) | Ø (mm) | H (mm) |      |
|---------|-------|--------|--------|--------|------|
| YT-4594 | 440   | 340    | 50     | 87.5   | 6/36 |

GB Dead blow mallet  
 D Rückschlagsfreier Schonhammer  
 PL Młotek bezodrzutowy  
 RUS Молоток безинерционный  
 CZ Palička nárazová plněná celogumová  
 H Visszarúgás mentes gumikalapács  
 RO Ciocan cu absorbție  
 E Martillo sin reacción

**PU**



| YATO    | m (g) | L (mm) | Ø (mm) | H (mm) |      |
|---------|-------|--------|--------|--------|------|
| YT-4620 | 740   | 300    | 44.5   | 100.0  | 4/24 |
| YT-4622 | 900   | 336    | 53.5   | 100.0  | 4/24 |
| YT-4623 | 1300  | 350    | 59.0   | 118.5  | 3/12 |

GB PU & nylon heads mallet  
 D Schonhammer mit PU & Nylon-Schlagkopf  
 PL Młotek blacharski  
 RUS Молоток рихтовочный  
 CZ Palička klempířská  
 H Vaskalapács  
 RO Ciocan tinichigerie cap PU / nylon  
 E Martillo chapista



**PU NYLON**

| YATO    | m (g) | L (mm) | Ø (mm) | H (mm) |      |
|---------|-------|--------|--------|--------|------|
| YT-4630 | 150   | 250    | 22     | 75     | 6/48 |
| YT-4631 | 250   | 280    | 28     | 85     | 6/36 |
| YT-4632 | 340   | 315    | 35     | 95     | 6/36 |
| YT-4633 | 660   | 350    | 45     | 105    | 6/24 |
| YT-4634 | 1340  | 380    | 60     | 132    | 4/16 |

GB PU head for mallet  
 D Polyurethan Schlagkopf  
 PL Końcówka PU do młotka  
 RUS Наконечник молотка из полиуретана  
 CZ Náhradní koncovka k paličce PU  
 H PU kalapácsfej cserélhető  
 RO Cap PU pt. ciocan tinichigerie  
 E Cabeza PU para martillo chapista

**PU**

**SOFT MIEKKA**

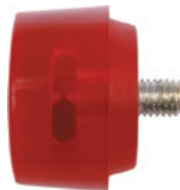

| YATO    | Ø (mm) | for / dla |      |
|---------|--------|-----------|------|
| YT-4635 | 22     | YT-4630   | 6/60 |
| YT-4636 | 28     | YT-4631   | 6/60 |
| YT-4637 | 35     | YT-4632   | 6/60 |
| YT-4638 | 45     | YT-4633   | 6/60 |
| YT-4639 | 60     | YT-4634   | 6/60 |

GB Rubber mallet with wooden handle  
 D Gummihammer mit Holzstiel  
 PL Młotek gumowy z drewnianym trzonkiem  
 RUS Молоток резиновый

CZ Pryžové kladívko  
 H Gumikalapács  
 RO Ciocan de cauciuc  
 E Mazo de goma



| YATO    | m (g) | L (mm) | Ø (mm) | H (mm) |       |
|---------|-------|--------|--------|--------|-------|
| YT-4600 | 230   | 259    | 44     | 71.0   | 12/48 |
| YT-4601 | 340   | 291    | 49     | 79.5   | 12/48 |
| YT-4602 | 370   | 300    | 50     | 87.5   | 6/36  |
| YT-4603 | 580   | 341    | 58     | 96.0   | 6/36  |
| YT-4604 | 780   | 341    | 63     | 117.0  | 6/36  |
| YT-4605 | 980   | 345    | 72     | 122.0  | 6/24  |

GB Dead blow mallet  
 D Rückschlagsfreier Schonhammer  
 PL Młotek bezodrzutowy  
 RUS Молоток безинерционный

CZ Palička nárazová plněná celogumová  
 H Visszarúgás mentes gumikalapács  
 RO Ciocan cu absorbție  
 E Martillo sin reacción

**PU**



| YATO    | m (g) | L (mm) | Ø (mm) | H (mm) |       |
|---------|-------|--------|--------|--------|-------|
| YT-4624 | 265   | 318    | 30.0   | 94     | 10/40 |
| YT-4625 | 430   | 350    | 40.0   | 100    | 6/36  |
| YT-4626 | 490   | 348    | 45.0   | 110    | 6/36  |

GB Nylon head for mallet  
 D Nylon Schlagkopf  
 PL Końcówka nylonowa do młotka  
 RUS Наконечник молотка из твердого нейлона  
 CZ Náhradní koncovka k paličce nylon  
 H Müanyag kalapácsfej cserélhető  
 RO Cap nylon pt. ciocan tinichigerie  
 E Cabeza de nylon para martillo chapista

**NYLON**

**HARD TWARDA**



| YATO    | Ø (mm) | for / dla |      |
|---------|--------|-----------|------|
| YT-4640 | 22     | YT-4630   | 6/60 |
| YT-4641 | 28     | YT-4631   | 6/60 |
| YT-4642 | 35     | YT-4632   | 6/60 |
| YT-4643 | 45     | YT-4633   | 6/60 |
| YT-4644 | 60     | YT-4634   | 6/60 |

- GB Auto body fender set  
D Karosserie-Ausbeulsatz  
PL Komplet młotków blacharskich  
RUS Молотки рихтовочные  
CZ Souprava klempířských kladívek  
H Bádogos kalapács készlet  
RO Set de ciocane de tablă  
E Juego de mazos de hojalatero



7  
PCS



DROP  
FORGED  
KUTE

GENUINE  
HICKORY





BMC  
& COLOR  
SLEEVE



| YATO  | m (g) |  |
|--|-------|---|
| YT-4590  | 4900  | 4   |



- GB Ball pein hammer  
D Ausbeulhammer  
PL Młotek blacharski  
RUS Молоток рихтовочный
- CZ Klempířské kladívko  
H Bádogos kalapács  
RO Ciocan pt. tabla  
E Martillo de hojalatero



| YATO  | m (g) | L (mm) | A (mm) | H (mm) |  |
|--|-------|--------|--------|--------|---|
| YT-4515  | 225   | 280    | 26     | 80     | 6/36  |
| YT-4516  | 450   | 315    | 34     | 100    | 6/24  |
| YT-4517  | 680   | 370    | 36     | 115    | 6/12  |
| YT-4518  | 900   | 380    | 40     | 125    | 6/12  |

- GB Ball pein hammer  
D Ausbeulhammer  
PL Młotek blacharski  
RUS Молоток рихтовочный
- CZ Klempířské kladívko  
H Bádogos kalapács  
RO Ciocan pt. tabla  
E Martillo de hojalatero





| YATO  | m (g) | L (mm) | A (mm) | H (mm) |  |
|--|-------|--------|--------|--------|---|
| YT-4519  | 225   | 295    | 26     | 80     | 6/36  |
| YT-4520  | 450   | 335    | 35     | 100    | 6/24  |
| YT-4521  | 680   | 360    | 36     | 115    | 6/12  |
| YT-4522  | 900   | 380    | 40     | 125    | 6/12  |

- GB Claw hammer  
D Schusterhammer  
PL Młotek szewski  
RUS Молоток гвоздоёр
- CZ Ševcovské kladívko  
H Cipész kalapács  
RO Ciocan de cizmărie  
E Martillo sacador



\* - product not for european market  
\* - produkt nieprzeznaczony na rynek europejski

| YATO  | m (g) | L (mm) | A (mm) | H (mm) |  |
|--|-------|--------|--------|--------|---|
| YT-4523*   | 225   | 290    | 25     | 110    | 6/36  |
| YT-4524*   | 370   | 310    | 32     | 120    | 6/24  |
| YT-4525*   | 450   | 332    | 30     | 135    | 6/24  |
| YT-4526*   | 570   | 329    | 34     | 135    | 6/18  |
| YT-4527*   | 680   | 383    | 34     | 140    | 6/12  |

GB Wood chisel  
D Stechbeitel  
PL Dłuto stolarskie  
RUS Долото

CZ Řezbářské dláto  
H Asztalos véső  
RO Daltă de tâmplărie  
E Cincel para madera

DOUBLE  
BLISTER



CrV  
60  
HRC  
56-62



| YATO    | size / rozmiar (mm) |       |
|---------|---------------------|-------|
| YT-6241 | 8                   | 10/60 |
| YT-6242 | 10                  | 10/60 |
| YT-6243 | 12                  | 10/60 |
| YT-6244 | 14                  | 10/60 |
| YT-6245 | 15                  | 10/60 |
| YT-6246 | 16                  | 10/60 |
| YT-6247 | 18                  | 10/60 |

| YATO    | size / rozmiar (mm) |       |
|---------|---------------------|-------|
| YT-6248 | 20                  | 10/60 |
| YT-6249 | 22                  | 10/60 |
| YT-6251 | 25                  | 10/60 |
| YT-6253 | 28                  | 10/60 |
| YT-6256 | 35                  | 10/60 |
| YT-6258 | 38                  | 10/60 |

GB Chisel set  
D Meißelsatz  
PL Zestaw dłut

RUS Набор зубил  
CZ Sada dlát  
H Hidegvágó készlet

RO Set de dălți  
E Juego de cinceles

4  
PCS  
10 16  
20 25  
mm  
CrV  
60  
HRC  
58-60



DOUBLE  
BLISTER

| YATO    |      |
|---------|------|
| YT-6260 | 5/20 |

GB Chisel set  
D Meißelsatz  
PL Zestaw dłut  
RUS Набор зубил

CZ Sada dlát  
H Hidegvágó készlet  
RO Set de dălți  
E Juego de cinceles

3  
PCS  
CrV  
16 25  
32 mm



PLASTIC  
HANGER

| YATO    |       |
|---------|-------|
| YT-6280 | 10/30 |

4  
PCS  
CrV  
10 12  
16 20  
mm



PLASTIC  
HANGER

| YATO    |      |
|---------|------|
| YT-6281 | 6/24 |

GB Cold chisel with protection  
D Schlitzmeißel mit Handschutz  
PL Przecinak z osłoną  
RUS Зубило с протектором  
CZ Plochý sekáč (z krytem)

H Hidegvágó, lapos (védőfejjel)  
RO Daltă - tăietor plată (cu apărătoare)  
E Cincel plano (con protector)

25x300  
mm  
CrV

76x267  
mm  
CrV



PLASTIC  
HANGER

| YATO    | L (mm) |      |
|---------|--------|------|
| YT-4700 | 300    | 4/24 |

GB Cold chisel with protection  
D Schlitzmeißel mit Handschutz  
PL Przecinak z osłoną  
RUS Зубило с протектором  
CZ Plochý sekáč (z krytem)

H Hidegvágó, lapos (védőfejjel)  
RO Daltă - tăietor plată (cu apărătoare)  
E Cincel plano (con protector)



PLASTIC  
HANGER

| YATO    | L (mm) |      |
|---------|--------|------|
| YT-4701 | 267    | 4/24 |

GB Punch with protection  
D Spitzmeißel mit Handschutz  
PL Przebijak z osłoną  
RUS Скарпель с пластмассовой ручкой  
CZ Zednický průbojník (z krytem)  
H Falvéső (védőfejjel)  
RO Dorn (perforator) pt. perete (cu apărătoare)  
E Cincel de cerrajería con protector

300  
mm  
CrV

6  
PCS  
CHISEL  
12x180 mm  
16x180 mm  
19x180 mm  
PUNCH  
3x180 mm  
3x180 mm  
4x180 mm  
CrV



PLASTIC  
HANGER

| YATO    | L (mm) |      |
|---------|--------|------|
| YT-4705 | 300    | 4/24 |

GB Chisel and punch set  
D Trenmeißel- und Durchtreiber-Satz  
PL Zestaw przecinaków i punktaków z prотектором  
CZ Sekáče a průbojníky  
H Véső és lyukasztó készlet  
RO Set dalti de impact  
E Juego de cinceles de acero templado y punzones



PLASTIC  
HANGER



| YATO    | L (mm) |       |
|---------|--------|-------|
| YT-4710 | 180    | 10/20 |

# Hammers, chisels, punches & axes Młotki, dłuta, przecinaki i siekiery



GB Cold chisel  
D Flachmeißel  
PL Przecinak płaski  
RUS Зубило плоское

CZ Sekáč plochý  
H Laposvágó  
RO Dalta lata  
E Tajadera en frío



| YATO     | L (mm) | chisel width / szerokosc dluta (mm) |        |
|----------|--------|-------------------------------------|--------|
| YT-47147 | 142    | 10.0                                | 20/120 |
| YT-47148 | 152    | 12.5                                | 20/120 |
| YT-47149 | 172    | 16.0                                | 20/120 |



SLIDING CARD

GB Taper punch  
D Durchtreiber  
PL Dobijak stożkowy  
RUS Пробойник конусный

CZ Průbojník  
H Lyukasztó  
RO Dorn conic  
E Retacador de cono



| YATO     | L (mm) | pin diameter / średnica grotu (mm) |        |
|----------|--------|------------------------------------|--------|
| YT-47141 | 150    | 1.5                                | 20/120 |
| YT-47142 | 150    | 3.0                                | 20/120 |
| YT-47143 | 150    | 4.0                                | 20/120 |
| YT-47144 | 150    | 5.0                                | 20/120 |
| YT-47145 | 150    | 6.0                                | 20/120 |
| YT-47146 | 150    | 8.0                                | 20/120 |



SLIDING CARD

GB Taper punch  
D Durchtreiber  
PL Dobijak stożkowy  
RUS Пробойник конусный

CZ Průbojník  
H Lyukasztó  
RO Dorn conic  
E Retacador de cono

SLIDING CARD



| YATO     | L (mm) | center punch / średnica punktaka (mm) |        |
|----------|--------|---------------------------------------|--------|
| YT-47152 | 140    | 2.0                                   | 20/120 |



SLIDING CARD

GB Center punch  
D Körner  
PL Punktak  
RUS Пробойник - керн  
CZ Důlcík

H Pontozó  
RO Punctator  
E Retacador - punzón centrador

SLIDING CARD

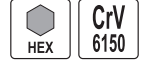

| YATO     | L (mm) | taper point end / średnica stożka (mm) |        |
|----------|--------|--|--------|
| YT-47150 | 100    | 6.0                                    | 20/120 |
| YT-47151 | 112    | 8.0                                    | 20/120 |



SLIDING CARD

GB Pin punch set  
D Splintentreiber Satz

PL Zestaw wybijaków  
RUS Пробойник булавоочный- набор

CZ Sada vyrážeců  
H Csapszegkiütő készlet

RO Set de dornuri  
E Juego de punzones

SLIDING CARD

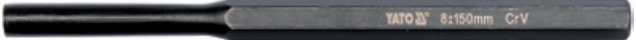
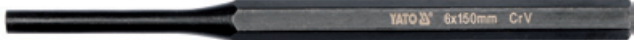
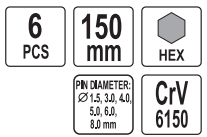

| YATO     | L (mm) |      |
|----------|--------|------|
| YT-47121 | 150    | 6/24 |

GB Chisel set  
D Flachmeißelsatz  
PL Zestaw przecinaków  
RUS Зубила в наборе

CZ Sekáče  
H Hidegvágó  
RO Set dalti zidarie  
E Cinceles

PLASTIC HANGER

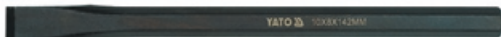

| YATO    |      |
|---------|------|
| YT-4711 | 6/24 |

GB Chisel and punch set  
D Trennmeißel- und Durchtreiber-Satz  
PL Zestaw przecinaków i punktaków  
RUS Зубила, керны и пробойники в наборе  
CZ Sekáče a průbojníky  
H Véső és lyukasztó készlet  
RO Set dalti de impact  
E Juego de cinceles de acero templado y punzones

PLASTIC HANGER

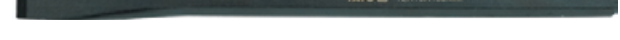
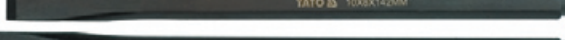
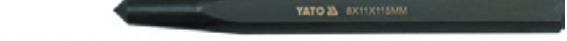
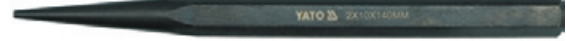
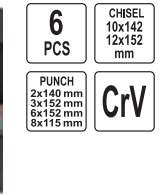

| YATO    |      |
|---------|------|
| YT-4712 | 6/24 |

GB Mini cold chisel and punch set  
 D Trennmeissel- und Durchtreiber-Satz  
 PL Zestaw wybijaków i przycinak  
 RUS Зубила и керны в наборе  
 CZ Sekáče a průbojníky  
 H Véső és lyukasztó készlet  
 RO Set dalți de impact  
 E Juego de cinceles de acero templado y punzones

PLASTIC HANGER



3 PCS  
 125 mm  
 CrV  
 COLD CHISEL: 10 mm  
 PIN PUNCH: 3 mm  
 SOLID PUNCH: 3 mm



**YATO** YT-4713 10/60

GB Chisel and punch set  
 D Trennmeissel- und Durchtreiber-Satz  
 PL Zestaw przycinaków i punktaków  
 RUS Зубила и керны в наборе  
 CZ Sekáče a průbojníky  
 H Véső és lyukasztó készlet  
 RO Set dalți de impact  
 E Juego de cinceles de acero templado y punzones

12 PCS  
 CrV  
 SOLID PUNCH: 4 mm  
 CENTER PUNCH: 90 DEGR. 6 mm 8 mm  
 PIN PUNCH: 1.5 mm 3 mm 4 mm 5 mm 6 mm 8 mm  
 COLD CHISEL: 10 mm 13 mm 16 mm

PLASTIC HANGER



**YATO** YT-4714 10/20

GB Pin punch  
 D Splintentreiber  
 PL Wybijał  
 RUS Пробойник булавочный  
 CZ Vyrážeč  
 H Csapszegkiütő  
 RO Dorn cilindric  
 E Punzón expulsador

SLIDING CARD



150 mm  
 CrV 60  
 PIN DIAMETER:  $\varnothing$  3.8 mm



**YATO** YT-4690 L (mm) 150 20/120

GB Taper punch  
 D Durchtreiber  
 PL Dobijał stożkowy  
 RUS Пробойник конусный  
 CZ Průbojník  
 H Lyukasztó  
 RO Dorn conic  
 E Retacador de cono

SLIDING CARD



120 mm  
 CrV 60  
 CENTER PUNCH:  $\varnothing$  3.3 mm

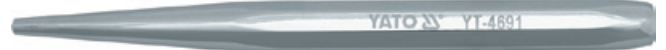

**YATO** YT-4691 L (mm) 120 20/120

GB Center punch  
 D Kömer  
 PL Dobijał punktak  
 RUS Пробойник - керн  
 CZ Důlčik  
 H Pontozó  
 RO Punctator  
 E Retacador - punzón centrador

SLIDING CARD



120 mm  
 CrV 60  
 TAPER POINT END



**YATO** YT-4692 L (mm) 120 20/120

GB Cold chisel  
 D Flach Meissel  
 PL Przycinak płaski  
 RUS Зубило плоское  
 CZ Sekáč plochý  
 H Laposvágó  
 RO Dalta lata  
 E Tajadera en frío

SLIDING CARD



130 mm  
 CrV 60  
 CHISEL WIDTH: 12 mm



**YATO** YT-4693 L (mm) 130 20/120

GB Cape chisel  
 D Kreuzmeissel  
 PL Przycinak prostokątny  
 RUS Зубило "лика"  
 CZ Sekáč křížový  
 H Keresztvágó  
 RO Dalta ascuțita  
 E Tajadera rectangular

SLIDING CARD



130 mm  
 CrV 60  
 CHISEL WIDTH: 5.5 mm



**YATO** YT-4694 L (mm) 130 20/120

GB Chisel and punch set  
 D Trennmeissel- und Durchtreiber-Satz  
 PL Zestaw przycinaków i punktaków  
 RUS Зубила и керны в наборе  
 CZ Sekáče a průbojníky  
 H Véső és lyukasztó készlet  
 RO Set dalți de impact  
 E Juego de cinceles de acero templado y punzones

SLIDING CARD



5 PCS  
 CrV 60  
 PIN PUNCH:  $\varnothing$  3.8 mm  
 TAPER PUNCH:  $\varnothing$  3.3 mm  
 TAPER POINT END  
 COLD CHISEL: 12 mm  
 CAPE CHISEL: 5.5 mm



**YATO** YT-4695 6/24



GB Hexagonal wrecking bar  
D Brechstange  
PL Łom sześciokątny  
RUS Лом-гвоздодёр шестигранный  
CZ Šestiúhlé páčidlo  
H Hatszögű feszítővas  
RO Ranga pt. scos cuie  
E Palanqueta

**DROP FORGED KUTE**



| YATO     | size / rozmiar (mm) |      |
|----------|---------------------|------|
| YT-46800 | 400x18              | 6/12 |
| YT-46801 | 450x18              | 6/12 |
| YT-46802 | 600x18              | 6/12 |
| YT-46803 | 750x18              | 6/12 |
| YT-46804 | 900x18              | 5/10 |

GB Profiled wrecking bar  
D Nageleisen  
PL Łom profilowany  
RUS Лом-гвоздодёр  
CZ Páčidlo  
H Szögkihúzó  
RO Ranga pt. scos cuie  
E Palanqueta

**DROP FORGED KUTE**



| YATO     | size / rozmiar (mm) |      |
|----------|---------------------|------|
| YT-46810 | 350x22x13           | 6/12 |
| YT-46811 | 450x30x17           | 6/12 |
| YT-46812 | 600x30x17           | 4/8  |
| YT-46813 | 750x30x17           | 4/8  |
| YT-46814 | 900x30x17           | 3/6  |

GB Flat wrecking bar  
D Nageleisen spitze  
PL Łom płaski  
RUS Лом плоский  
CZ Páčidlo ploché  
H Lapos feszítővas  
RO Ranga plata  
E Palanqueta

**DROP FORGED KUTE**

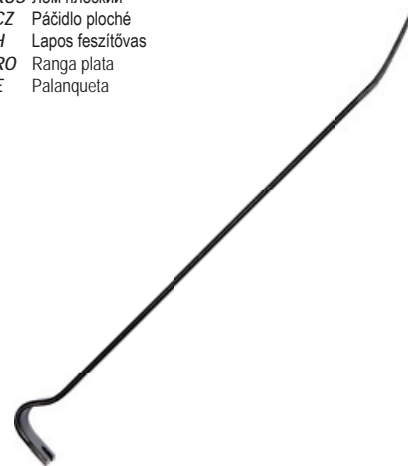

| YATO     | size / rozmiar (mm) |       |
|----------|---------------------|-------|
| YT-46820 | 300x35x6            | 10/30 |
| YT-46821 | 380x35x6            | 10/20 |
| YT-46822 | 450x35x6            | 10/20 |
| YT-46823 | 600x35x6            | 10/20 |

GB Go-through pry bar set  
D Nageleisensatz

PL Zestaw łomów  
RUS Набор ломов

CZ Sada mini páčidel  
H Szögghúzó készlet

RO Set leviere  
E Juego de palancas de hierro

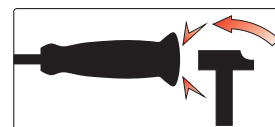

**4 PCS**

- 198x6x6 mm, 110 g
- 304x10x10 mm, 292 g
- 456x10x10 mm, 479 g
- 608x12x12 mm, 745 g

DOUBLE BLISTER

| YATO    |  |     |
|---------|--|-----|
| YT-4730 |  | 3/6 |

GB Axe  
D Beil Hicorystiel

PL Siekiera  
RUS Топор

CZ Sekerka  
H Szekerce

RO Secure  
E Hacha

**DIN 5131 7294**

**GENUINE HICKORY**

Timber wedge and steel ring

Genuine hickory shaft



Forged carbon steel head hardened and tempered

| YATO    | m (g) | L (mm) | DIN  |    |
|---------|-------|--------|------|----|
| YT-8001 | 600   | 360    | 5131 | 24 |
| YT-8002 | 800   | 380    | 5131 | 20 |
| YT-8003 | 1000  | 430    | 5131 | 12 |
| YT-8004 | 1250  | 710    | 7294 | 12 |
| YT-8005 | 1400  | 710    | 7294 | 12 |
| YT-8006 | 1600  | 810    | 7294 | 12 |

GB Axe  
D Beil Hicorystiel

PL Siekiera  
RUS Топор

CZ Sekerka  
H Szekerce

RO Secure  
E Hacha

**GENUINE HICKORY**

Timber wedge and steel ring

Genuine hickory shaft



Forged carbon steel head hardened and tempered

| YATO    | m (g) | L (mm) |   |
|---------|-------|--------|---|
| YT-8011 | 1000  | 515    | 6 |
| YT-8012 | 2000  | 820    | 6 |

# 9

## Clamps, vices & holders Ściski, imadła i wsporniki



Clamps  
Ściski

.....156-157



Magnetic holders  
Wsporniki magnetyczne

.....158

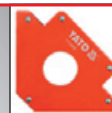

Vices  
Imadła

.....157



- GB F-clamp
- D Schraubzwinde
- PL Ścisk stolarski
- RUS Струбцина
- CZ Truhlářské upínadlo
- H Asztalos szorító
- RO Menghină pt. tâmplărie
- E Tornillo de apriete

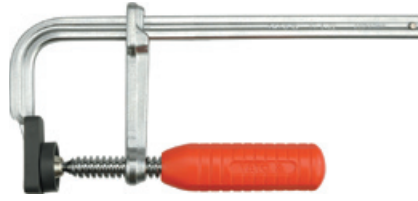

**QUICK ADJUSTMENT SZYBKĄ REGULACJĄ**



**QUICK ADJUSTMENT SZYBKĄ REGULACJĄ**

| YATO    | L (mm) |       |
|---------|--------|-------|
| YT-6401 | 160x80 | 10/30 |
| YT-6402 | 200x80 | 10/30 |
| YT-6403 | 250x80 | 10/30 |
| YT-6404 | 300x80 | 10/30 |
| YT-6405 | 450x80 | 10/20 |

| YATO    | L (mm)  |       |
|---------|---------|-------|
| YT-6406 | 600x80  | 10/20 |
| YT-6407 | 400x120 | 10    |
| YT-6408 | 500x120 | 10    |
| YT-6409 | 600x120 | 10    |
| YT-6410 | 900x120 | 5     |

| YATO    | L (mm)   |    |
|---------|----------|----|
| YT-6412 | 300x120  | 10 |
| YT-6413 | 400x120  | 10 |
| YT-6414 | 500x120  | 5  |
| YT-6415 | 600x120  | 5  |
| YT-6416 | 900x120  | 5  |
| YT-6417 | 1050x120 | 5  |



| YATO    | L (mm) |       |
|---------|--------|-------|
| YT-6440 | 100x50 | 12/60 |
| YT-6441 | 150x50 | 12/48 |
| YT-6442 | 200x50 | 12/48 |
| YT-6443 | 250x50 | 12/48 |
| YT-6444 | 300x50 | 12/48 |
| YT-6445 | 200x80 | 10/20 |
| YT-6446 | 250x80 | 10/20 |
| YT-6447 | 300x80 | 10/20 |

| YATO    | L (mm)   |       |
|---------|----------|-------|
| YT-6448 | 500x80   | 10/20 |
| YT-6449 | 300x120  | 10    |
| YT-6450 | 500x120  | 10    |
| YT-6451 | 800x120  | 6     |
| YT-6452 | 1000x120 | 6     |
| YT-6453 | 1200x120 | 6     |
| YT-6454 | 1500x120 | 6     |

9

- GB Quick release clamp
- D Schnellklemme
- PL Ścisk szybkozaciskowy
- RUS Быстрозажимная струбцина
- CZ Svěrka rychloupínací
- H Gyors asztalos szorító

- RO Clemă cu prindere rapidă
- E Apretador rápido

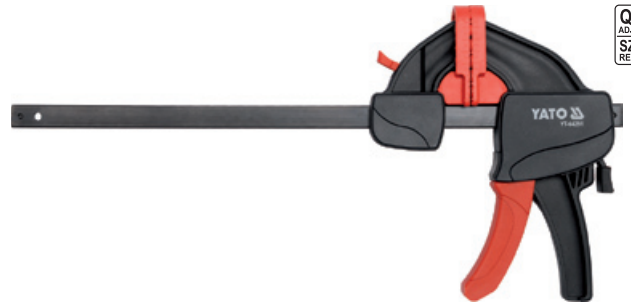

**QUICK ADJUSTMENT SZYBKĄ REGULACJĄ**

| YATO     | L (mm) | max. expand range / max. zasięg rozpięcia (mm) | max. clamping range / max. zasięg ściskania (mm) | max. jaws depth / max. głębokość szczęk (mm) |      |
|----------|--------|--|--|--|------|
| YT-64280 | 200    | 247-515  | 0-203  | 92   | 6/18 |
| YT-64281 | 300    | 247-616  | 0-304  | 92   | 6/12 |
| YT-64282 | 450    | 247-769  | 0-457  | 92   | 6/12 |
| YT-64283 | 600    | 247-921  | 0-609  | 92   | 6/12 |
| YT-64284 | 750    | 247-1074                                       | 0-762  | 92   | 4/8  |

| YATO     | L (mm) | max. expand range / max. zasięg rozpięcia (mm) | max. clamping range / max. zasięg ściskania (mm) | max. jaws depth / max. głębokość szczęk (mm) |      |
|----------|--------|--|--|--|------|
| YT-64290 | 200    | 206-456  | 0-203  | 85   | 6/18 |
| YT-64291 | 300    | 206-557  | 0-304  | 85   | 6/18 |
| YT-64292 | 450    | 206-710  | 0-457  | 85   | 6/12 |
| YT-64293 | 600    | 206-862  | 0-609  | 85   | 6/12 |
| YT-64294 | 750    | 206-1015                                       | 0-762  | 85   | 6/12 |
| YT-64295 | 900    | 206-1167                                       | 0-914  | 85   | 6/12 |

- GB Spring clamp
- D Federklemme
- PL Ścisk sprężynowy
- RUS Струбцина
- CZ Pružinové upínadlo
- H Rugós szorító
- RO Cleste presa pt. lemn
- E Pinza



| YATO     | L (mm) | max. jaws range / max. zasięg szczęk (mm) | max. jaws depth / max. głębokość szczęk (mm) |        |
|----------|--------|---|--|--------|
| YT-64270 | 100    | 42  | 44   | 24/240 |
| YT-64271 | 150    | 55  | 68   | 12/120 |
| YT-64272 | 200    | 79  | 91   | 10/100 |

- GB C-Clamp
- D C-Schraubzwinde
- PL Ścisk typu „C”
- RUS Струбцина типа „С”
- CZ Svěrka tvaru „C”
- H Pillanatszorító
- RO Menghină tip „C”
- E Tornillo tipo „C”



**DROP FORGED KUTE**

| YATO    | size / rozmiar (mm) | force pressure / sila nacisku (kg) |      |
|---------|---------------------|------------------------------------|------|
| YT-6420 | 50                  | 1500                               | 6/30 |
| YT-6421 | 75                  | 1950                               | 6/18 |
| YT-6422 | 100                 | 2980                               | 6/12 |
| YT-6423 | 150                 | 3200                               | 6/12 |
| YT-6424 | 200                 | 3600                               | 6    |

| YATO    | size / rozmiar (mm) | force pressure / sila nacisku (kg) |       |
|---------|---------------------|------------------------------------|-------|
| YT-6426 | 50                  | 450                                | 12/24 |

- GB C-Clamp set  
D Schraubzwingsatz  
PL Zestaw ścisaków typu „C”  
RUS Набор струбцин С-образ  
CZ Svěrka tvaru „C”  
H Pillanatszorító  
RO Set menghine  
E Tornillos tipo „C”



3  
PCS  
DROP  
FORGED  
KUTE

POUCH  
& COLOR BOX



| YATO    | size / rozmiar (mm) | force pressure / siła nacisku (kg) |    |
|---------|---------------------|------------------------------------|----|
| YT-6419 | 25                  | 400                                | 24 |
|         | 50                  | 500                                |    |
|         | 75                  | 800                                |    |

- GB Swivel base bench vice  
D Drehbare Schraubstock  
PL Imadło ślusarskie obrotowe  
RUS Тиски слесарные поворотные  
CZ Zámečnický svěrák otáčivé  
H Satu, lakatos forgó  
RO Menghină rotativă  
E Tornillo de apriete giratorio

COLOR BOX



360°

- GB Swivel base bench vice  
D Drehbare Schraubstock  
PL Imadło ślusarskie obrotowe  
RUS Тиски слесарные поворотные  
CZ Zámečnický svěrák otáčivé  
H Satu, lakatos forgó  
RO Menghină rotativă  
E Tornillo de apriete giratorio

COLOR BOX



360°

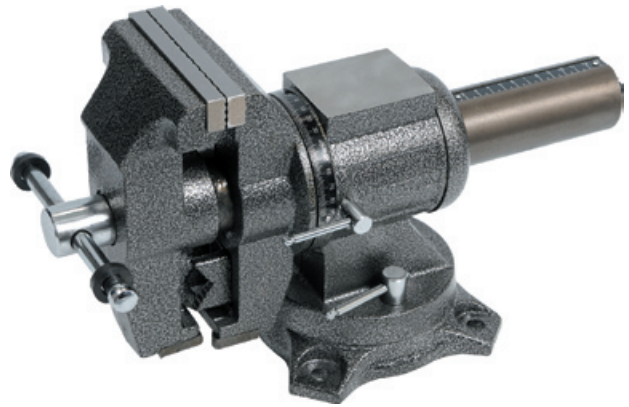

- anvil and changeable jaws made of hardened steel
- kowadełko i wymienne szczęki z hartowanej stali

|  |                 |                        |                          |    |  |   |
|--|-----------------|------------------------|--------------------------|----|--|---|
|  | <b>7</b><br>kg  | <b>YATO</b><br>YT-6501 | weight (kg)<br>waga (kg) | 7  |  | 2 |
|  | <b>10</b><br>kg | <b>YATO</b><br>YT-6502 | weight (kg)<br>waga (kg) | 10 |  | 2 |
|  | <b>15</b><br>kg | <b>YATO</b><br>YT-6503 | weight (kg)<br>waga (kg) | 15 |  | 1 |
|  | <b>21</b><br>kg | <b>YATO</b><br>YT-6504 | weight (kg)<br>waga (kg) | 21 |  | 1 |

- anvil and changeable jaws made of hardened steel
- kowadełko i wymienne szczęki z hartowanej stali

|  |  |  |  |  |                 |                        |                          |    |  |   |
|--|--|--|--|--|-----------------|------------------------|--------------------------|----|--|---|
|  |  |  |  | <b>HRC</b><br><b>45-52</b><br>JAWS/SZCZĘKI | <b>10</b><br>kg | <b>YATO</b><br>YT-6505 | weight (kg)<br>waga (kg) | 10 |  | 1 |
|  |  |  |  | <b>HRC</b><br><b>45-52</b><br>JAWS/SZCZĘKI | <b>20</b><br>kg | <b>YATO</b><br>YT-6506 | weight (kg)<br>waga (kg) | 20 |  | 1 |

- GB Hinged pipe vice  
D Rohrschraubstock  
PL Imadło zaciskowe do rur  
RUS Тиски для труб  
CZ Upinací svěrák na trubky  
H Satu, csőszorító  
RO Menghină pt. țevi  
E Tornillo de apriete para tubos



S55C

COLOR BOX



| YATO    | ∅ (mm) |   |
|---------|--------|---|
| YT-6510 | 60     | 4 |
| YT-6511 | 76     | 2 |
| YT-6512 | 90     | 2 |
| YT-6513 | 110    | 1 |

- GB Adjustable angle welding magnet  
 D Verstellbarer Magnet-Werkstückhalter  
 PL Wspornik magnetyczny spawalniczy regulowany  
 RUS Регулируемый магнит заварки  
 CZ Pohovací magnetický držák ke svařování  
 H Állítható, mágneses, hegesztő támasz  
 RO Dispozitiv magnetic reglabil pt. sudura  
 E Soporte magnético de soldadura, ajustable



DOUBLE BLISTER



| YATO    | (kg)   | mm       |   |
|---------|--------|----------|---|
| YT-0862 | 2x22.5 | 85x65x22 | 6 |

- GB Magnetic welding holder  
 D Magnet-Werkstückhalter  
 PL Kątownik magnetyczny spawalniczy  
 RUS Магнитная струбцина заварки  
 CZ Magnetický uhelník ke svařování  
 H Mágneses, hegesztő szögvas  
 RO Dispozitiv magnetic fixare pt. sudura  
 E Escuadra magnética de soldadura

DOUBLE BLISTER

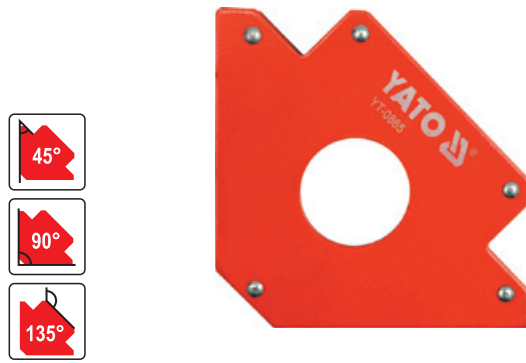

| YATO    | (kg) | mm        |      | YATO    | (kg) | Ø (mm) | mm         |      |
|---------|------|-----------|------|---------|------|--------|------------|------|
| YT-0863 | 11.5 | 82x120x13 | 6/48 | YT-0864 | 22.5 | 18     | 102x155x17 | 6/30 |
|         |      |           |      | YT-0865 | 34.0 | 46     | 122x190x25 | 6/18 |

- GB Magnetic welding holder  
 D Magnet-Werkstückhalter  
 PL Kątownik magnetyczny spawalniczy  
 RUS Магнитная струбцина заварки  
 CZ Magnetický uhelník ke svařování  
 H Mágneses, hegesztő szögvas  
 RO Dispozitiv magnetic fixare pt. sudura  
 E Escuadra magnética de soldadura

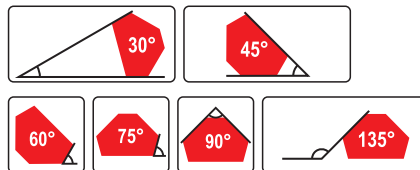

DOUBLE BLISTER



| YATO    | (kg) | mm         |      |
|---------|------|------------|------|
| YT-0866 | 11.5 | 64x95x14   | 6/24 |
| YT-0867 | 34.0 | 111x136x24 | 6/18 |

- GB Magnetic welding holder with switch  
 D Magnet-Werkstückhalter mit Schalter  
 PL Kątownik magnetyczny spawalniczy z wyłącznikiem  
 RUS Магнитный держатель заварки с выключателем  
 CZ Magnetický uhelník ke svařování s vypínačem  
 H Mágneses, hegesztő szögvas, kapcsolóval  
 RO Dispozitiv magnetic fixare pt. sudura cu intreruptor  
 E Escuadra magnética de soldadura, con interruptor

DOUBLE BLISTER

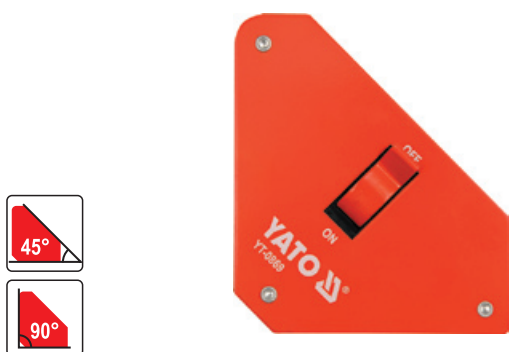

| YATO    | (kg) | mm         |      | YATO    | (kg) | mm         |      |
|---------|------|------------|------|---------|------|------------|------|
| YT-0868 | 13.5 | 85x139x25  | 6/36 | YT-0870 | 13.5 | 107x160x26 | 6/24 |
| YT-0869 | 25.0 | 117x192x32 | 6/18 |         |      |            |      |

Memo

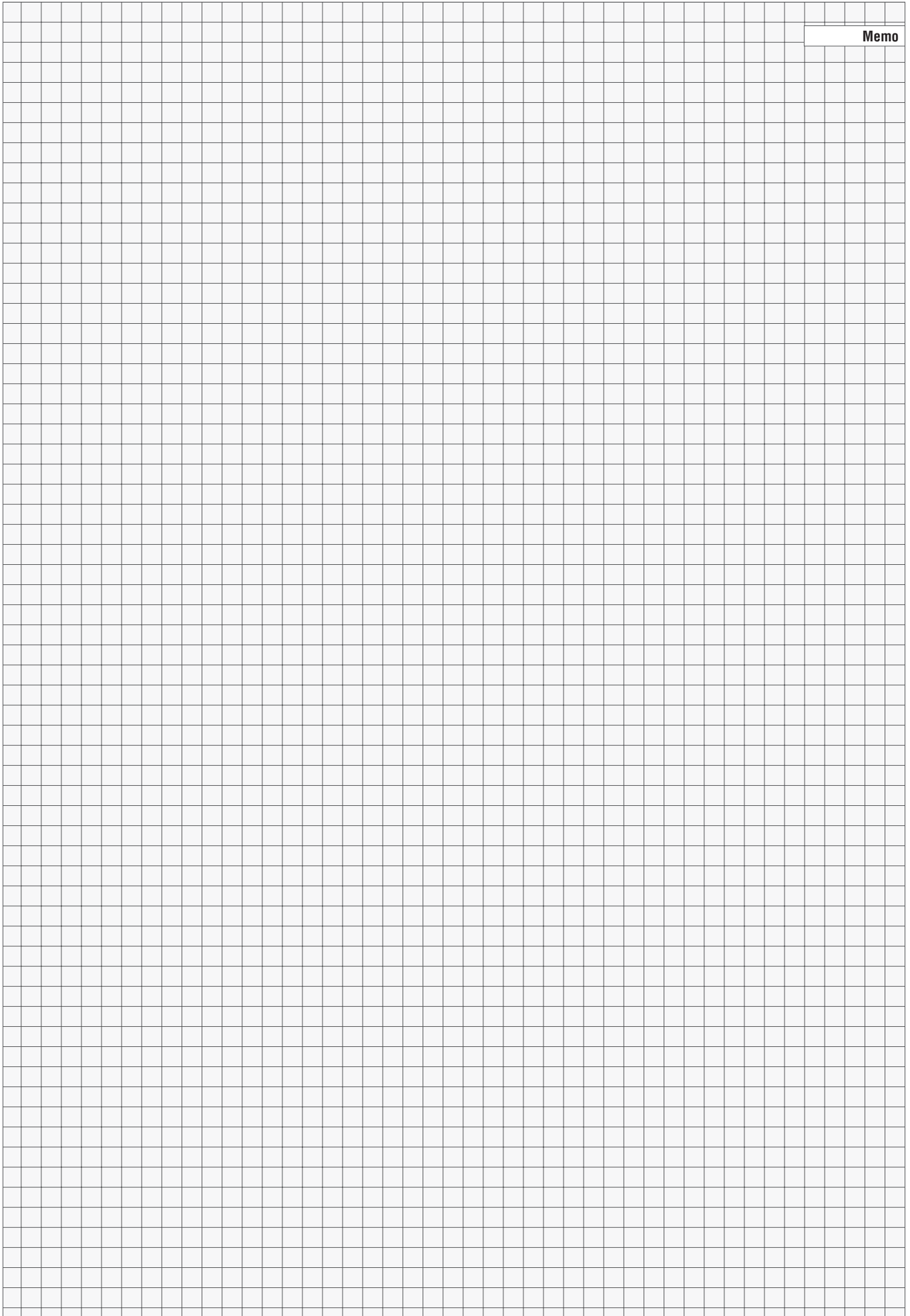

# 10

## Cutting tools Narzędzia tnące

**YATO** 

item number:  
**YT-6068**

**GB** TCT circular saw blade for cutting of wood

**D** Hartmetallbestückt

Kreissägeblatt

für schneiden von Holz

**PL** Pila tarczowa do drewna  
z węglikiem wolframu

**RUS** Пила дисковая по дереву  
(твердый сплав)

210x30x3.2x2.2HW

60T



10000 obr/min

**YATO** 

item number:  
**YT-6068**

**GB** TCT circular saw blade for cutting of wood

**D** Hartmetallbestückt

Kreissägeblatt

für schneiden von Holz

**PL** Pila tarczowa do drewna  
z węglikiem wolframu

**RUS** Пила дисковая по дереву  
(твердый сплав)

**RO** Ferăstrău circular  
cu dinți din wolfram pt. Lemn

210x30x3.2x2.2HW













60T





$n_{max}$  **8 000** obr/min





|  |   |   |   |
|--|---|---|---|
| <b>Drills</b><br>Wiertła   |    | <b>Diamond blades for cutting construction materials</b><br>Tarcze diamentowe do cięcia materiałów budowlanych..... | 176   |
| .....  | 163-169   | <b>Diamond blades for cutting concrete</b><br>Tarcze diamentowe do cięcia betonu.....                               | 176   |
| <b>Twist drill bits HSS, HSS-G &amp; sets</b><br>Wiertła do metalu HSS, HSS-G i zestawy.....                             | 163   | <b>Diamond blades for cutting stone</b><br>Tarcze diamentowe do cięcia kamienia.....                                | 176   |
| <b>Twist drill bits HSS-E Co</b><br>Wiertła do metalu HSS-E Co.....  | 165   | <b>Diamond blades for cutting ceramic tiles</b><br>Tarcze diamentowe do cięcia płytek ceramicznych.....             | 177   |
| <b>SDS masonry drill bits X-TIP</b><br>Wiertła do betonu SDS, z grotem krzyżowym.....                                    | 165   | <b>Diamond blades for cutting ceramic materials</b><br>Tarcze diamentowe do cięcia materiałów ceramicznych.....     | 177   |
| <b>SDS masonry drill bits</b><br>Wiertła do betonu SDS.....  | 166   | <b>Diamond blades for cutting asphalt</b><br>Tarcze diamentowe do cięcia asfaltu.....                               | 177   |
| <b>Masonry drill bits with cylindrical shank &amp; sets</b><br>Wiertła do betonu z uchwytem cylindrycznym i zestawy..... | 166   | <b>Diamond grinding cup wheels</b><br>Diamentowe tacerze szlifierskie do betonu i kamienia.....                     | 177   |
| <b>Flat wood drill bits &amp; sets</b><br>Wiertła łopatkowe do drewna i zestawy.....                                     | 167   | <b>Diamond core drill bits</b><br>Diamentowe wiertła koronowe.....  | 177   |
| <b>Spur wood drill bits</b><br>Wiertła do drewna spiralne.....   | 168   | <b>Tungsten carbide tipped tools</b><br>Narzędzia z ostrzem z węgliku wolframu                                      |    |
| <b>Auger wood drill bits &amp; sets</b><br>Świdry do drewna i zestawy.....   | 168   | .....   | 178   |
| <b>Drills for glass</b><br>Wiertła do szkła.....   | 169   | <b>Tungsten carbide saws for wood</b><br>Tarcze z węglikiem do drewna.....  | 178   |
| <b>Adjustable hand reamers</b><br>Rozwiertaki nastawne   |    | <b>Tungsten carbide saws for aluminium</b><br>Tarcze z węglikiem do aluminium.....                                  | 178   |
| .....  | 169   | <b>Cutting &amp; grinding discs</b><br>Tarcze do cięcia i szlifowania   |    |
| <b>SDS Chisels</b><br>Przecinaki i dłuta SDS   |   | .....   | 178-179   |
| .....  | 169   | <b>Stainless steel cutting discs</b><br>Tarcze do cięcia stali nierdzewnej.....                                     | 178   |
| <b>Hollow drill sets</b><br>Wiertła koronowe do betonu   |  | <b>Metal cutting discs</b><br>Tarcze do cięcia metalu.....  | 178   |
| .....  | 170   | <b>Metal grinding discs</b><br>Tarcze do szlifowania metalu.....  | 179   |
| <b>Bi-metal hole saws</b><br>Otwornice bimetalowe  |  | <b>Stone cutting discs</b><br>Tarcze do cięcia kamienia.....  | 179   |
| .....  | 170-171   | <b>Stone grinding discs</b><br>Tarcze do szlifowania kamienia.....  | 179   |
| <b>Bi-metal hole saws</b><br>Otwornice bimetalowe.....   | 170   | <b>Shears</b><br>Nożyce   |  |
| <b>Arbors for hole saws</b><br>Uchwyty do otwornic bimetalowych.....   | 170   | .....   | 180-184   |
| <b>Hole saw kits</b><br>Zestawy otwornic bimetalowych.....   | 171   | <b>Heavy duty cable cutters</b><br>Nożyce do cięcia przewodów.....  | 180   |
| <b>Taps &amp; dies</b><br>Narzędzia do gwintowania   |  | <b>Tin snips</b><br>Nożyce do blachy.....   | 180   |
| .....  | 172-174   | <b>Steel strap cutters</b><br>Nożyce do cięcia taśm stalowych.....  | 183   |
| <b>Hand taps &amp; sets</b><br>Gwintowniki i zestawy.....  | 170   | <b>Bolt cutters</b><br>Nożyce do prętów.....  | 183   |
| <b>Circular dies</b><br>Narzynki.....  | 173   | <b>Hydraulic cutters &amp; accessories</b><br>Nożyce z siłownikiem hydraulicznym i akcesoria.....                   | 184   |
| <b>Tap wrenches &amp; die holders</b><br>Pokręta do gwintowników i narzynek.....   | 173   | <b>Cable cutters</b><br>Nożyce do kabli.....  | 184   |
| <b>Thread repair sets &amp; accessories</b><br>Zestawy do naprawy gwintów i akcesoria.....                               | 174   | <b>Multifunctional scissors</b><br>Nożyce wielofunkcyjne.....   | 184   |
| <b>Router bits</b><br>Frezy do drewna  |  | <b>Saws &amp; blades</b><br>Piły i brzeszczoty  |  |
| .....  | 175   | .....   | 185-188   |
| <b>Diamond tools</b><br>Narzędzia diamentowe   |  | <b>Hand saws</b><br>Piły do drewna.....   | 185   |
| .....  | 176-177   | <b>Bow saws</b><br>Piły kabłąkowe.....  | 185   |
|  |   | <b>Blades</b><br>Brzeszczoty.....   | 186   |
|  |   | <b>Hacksaw frames</b><br>Piły do metalu.....  | 186   |



|  |         |         |   |
|--|---------|---------|---|
| Hacksaw frame blades<br>Brzeszczoty do metalu.....                                 | 186     | 203-208 |  |
| Jig saw blades<br>Brzeszczoty do wyrzynarek.....                                   | 187     |         |   |
| <b>Abrasive products</b><br><b>Artykuły ściernie</b>                               |         |         |   |
| <b>Brushes, knives &amp; files</b><br><b>Szczotki, noże i pilniki</b>              | 188-202 |         |   |
|   |         |         |   |
| <b>Wire brushes &amp; sets</b><br>Szczotki druciane i zestawy.....                 | 188     |         |   |
| <b>Cup brushes</b><br>Szczotki tarczowe.....                                       | 191     |         |   |
| <b>Knives &amp; blades</b><br>Noże i ostrza.....                                   | 192     |         |   |
| <b>Scissors</b><br>Nożyczki.....   | 195     |         |   |
| <b>Profile gauges</b><br>Wzorniki profili.....                                     | 196     |         |   |
| <b>Punch sets</b><br>Przebijaki do skóry.....                                      | 196     |         |   |
| <b>Cutters</b><br>Obcinaki.....  | 197     |         |   |
| <b>Window scrapers</b><br>Skrobaki do szyb.....                                    | 198     |         |   |
| <b>Scrapers</b><br>Cykliny metalowe.....   | 198     |         |   |
| <b>Steel files &amp; sets</b><br>Pilniki do metalu i zestawy.....                  | 199     |         |   |
| <b>Needle file sets</b><br>Zestawy pilników iglaków.....                           | 200     |         |   |
| <b>Diamond needle files &amp; sets</b><br>Pilniki iglaki diamentowe i zestawy..... | 200     |         |   |
| <b>Rasps &amp; sets</b><br>Tarniki do drewna i zestawy.....                        | 202     |         |   |
|  |         |         | <b>Sand papers</b><br>Papiery ściernie.....   |
|  |         |         | 203   |
|  |         |         | <b>Waterproof sand papers</b><br>Papiery ściernie wodoodporne.....                  |
|  |         |         | 204   |
|  |         |         | <b>Abrasive clothes</b><br>Płótna ściernie.....                                     |
|  |         |         | 205   |
|  |         |         | <b>No end abrasive bands</b><br>Taśmy ściernie bezkońcowe.....                      |
|  |         |         | 205   |
|  |         |         | <b>Flap discs</b><br>Ściernice listkowe.....  |
|  |         |         | 206   |
|  |         |         | <b>Abrasive sheets and discs</b><br>Arkusze i krążki ściernie.....                  |
|  |         |         | 208   |
|  |         |         | <b>Sanding blocks</b><br>Bloki ściernie.....  |
|  |         |         | 208   |

GB Twist drill HSS  
D Metallspiralbohrer HSS  
PL Wiertło do metalu HSS  
RUS Сверло по металлу HSS

CZ Vrták na kov HSS  
H Fúrószár fémhez HSS  
RO Burghiu pt. metal HSS  
E Broca para metal HSS

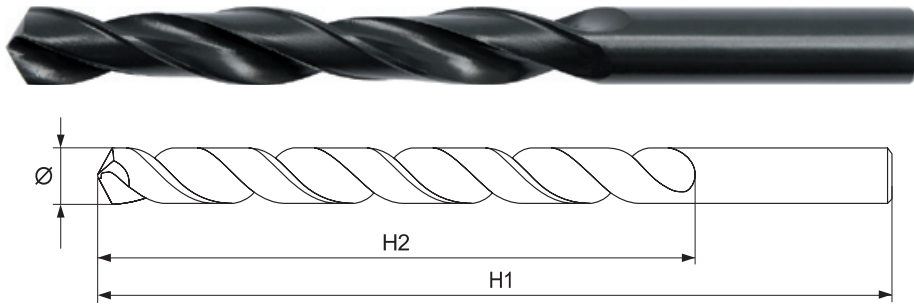
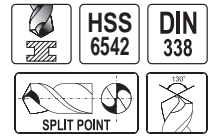

- application: industry
- for precise drilling in steels, cast steels, non-ferrous metals, plastics
- przeznaczenie: przemysł
- do precyzyjnych wierceń w stalach, żeliwach, metalach nieżelaznych, tworzywach sztucznych



| YATO    | Ø (mm) | H1 (mm) | H2 (mm) | RPM <sub>max</sub> | PCS packing |        |
|---------|--------|---------|---------|--------------------|-------------|--------|
| YT-4430 | 1.0    | 34      | 12      | 3800               | 10          | 80/320 |
| YT-4431 | 1.5    | 43      | 20      | 3800               | 10          | 80/320 |
| YT-4432 | 2.0    | 49      | 24      | 4000               | 10          | 80/320 |
| YT-4433 | 2.5    | 57      | 30      | 3200               | 10          | 80/320 |
| YT-4434 | 2.8    | 61      | 33      | 2800               | 10          | 80/320 |
| YT-4435 | 3.0    | 61      | 33      | 2600               | 10          | 80/320 |
| YT-4436 | 3.2    | 65      | 36      | 2500               | 10          | 80/320 |
| YT-4437 | 3.5    | 70      | 39      | 2300               | 10          | 80/320 |
| YT-4438 | 4.0    | 75      | 43      | 2000               | 10          | 80/320 |
| YT-4439 | 4.2    | 75      | 43      | 1900               | 10          | 20/80  |
| YT-4440 | 4.5    | 80      | 47      | 1800               | 10          | 20/80  |
| YT-4441 | 4.8    | 86      | 52      | 1600               | 10          | 20/80  |
| YT-4442 | 5.0    | 86      | 52      | 1600               | 10          | 20/80  |
| YT-4443 | 5.2    | 86      | 52      | 1500               | 10          | 20/80  |
| YT-4444 | 5.5    | 93      | 57      | 1500               | 10          | 20/80  |

| YATO    | Ø (mm) | H1 (mm) | H2 (mm) | RPM <sub>max</sub> | PCS packing |       |
|---------|--------|---------|---------|--------------------|-------------|-------|
| YT-4445 | 6.0    | 93      | 57      | 1300               | 10          | 20/80 |
| YT-4446 | 6.5    | 101     | 63      | 1200               | 10          | 10/40 |
| YT-4447 | 7.0    | 109     | 69      | 1100               | 10          | 10/40 |
| YT-4448 | 7.5    | 109     | 69      | 1100               | 10          | 10/40 |
| YT-4449 | 8.0    | 117     | 75      | 1000               | 10          | 10/40 |
| YT-4450 | 8.5    | 117     | 75      | 900                | 5           | 10/40 |
| YT-4451 | 9.0    | 125     | 81      | 900                | 5           | 10/40 |
| YT-4452 | 9.5    | 125     | 81      | 800                | 5           | 10/40 |
| YT-4453 | 10.0   | 133     | 87      | 800                | 5           | 10/40 |
| YT-4454 | 10.5   | 133     | 87      | 800                | 3           | 10/40 |
| YT-4455 | 11.0   | 142     | 94      | 700                | 3           | 10/40 |
| YT-4456 | 12.0   | 151     | 101     | 700                | 3           | 10/40 |
| YT-4457 | 12.5   | 151     | 101     | 600                | 3           | 10/40 |
| YT-4458 | 13.0   | 151     | 101     | 600                | 3           | 10/40 |

GB Twist drill set  
D Metallspiralbohrersatz  
PL Komplet wiertel do metalu  
RUS Набор сверл по металлу

CZ Souprava vrtáků na kov  
H Fúrószárkészlet fémhez  
RO Set de burghie pt. metal  
E Broca para metal

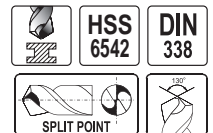

6  
PCS

Ø mm  
2-8

PLASTIC  
HANGING BOX

| YATO    | Ø (mm)           |       |
|---------|------------------|-------|
| YT-4460 | 2; 3; 4; 5; 6; 8 | 15/60 |

10  
PCS

Ø mm  
1-10

PLASTIC  
HANGING BOX

| YATO    | Ø (mm)                        |       |
|---------|-------------------------------|-------|
| YT-4461 | 1; 2; 3; 4; 5; 6; 7; 8; 9; 10 | 20/40 |

19  
PCS

Ø mm  
1-10

PLASTIC  
HANGING BOX

| YATO    | Ø (mm)   |       |
|---------|--|-------|
| YT-4462 | 1.0; 1.5; 2.0; 2.5; 3.0; 3.5; 4.0; 4.5; 5.0; 5.5; 6.0; 6.5; 7.0; 7.5; 8.0; 8.5; 9.0; 9.5; 10.0 | 15/30 |

GB Twist drill HSS-G  
 D Metallspiralbohrer HSS-G  
 PL Wiertło do metalu szlifowane HSS-G  
 RUS Сверло по металлу HSS-G

CZ Vrták na kov HSS-G  
 H Fúrószerű fémhez HSS-G  
 RO Burghiu pt. metal HSS-G  
 E Broca para metal HSS-G

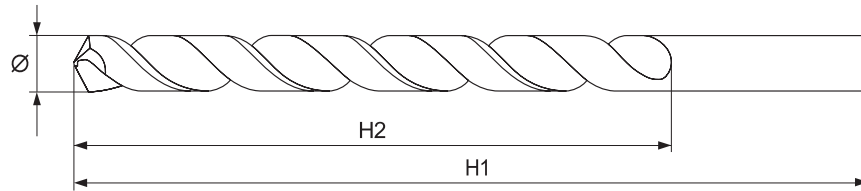

• application: industry  
 • for precise drilling in steels, cast steels, non-ferrous metals, plastics

• przeznaczenie: przemysł  
 • do precyzyjnych wierceń w stalach, żeliwach, metalach nieżelaznych, tworzywach sztucznych

\* - product not for european market  
 \* - produkt nieprzeznaczony na rynek europejski



BLISTER IN CARD

| YATO     | Ø (mm) | H1 (mm) | H2 (mm) | RPM.max. | PCS packing | Box    |
|----------|--------|---------|---------|----------|-------------|--------|
| YT-3900* | 1.0    | 34      | 12      | 4500     | 10          | 80/320 |
| YT-3903  | 1.5    | 40      | 18      | 4500     | 10          | 80/320 |
| YT-3905* | 2.0    | 49      | 24      | 4500     | 10          | 80/320 |
| YT-3910* | 2.5    | 57      | 30      | 3000     | 10          | 80/320 |
| YT-3913  | 2.8    | 61      | 33      | 3000     | 10          | 80/320 |
| YT-3914* | 3.0    | 61      | 33      | 3000     | 10          | 80/320 |
| YT-3916* | 3.2    | 65      | 36      | 3000     | 10          | 80/320 |
| YT-3919* | 3.5    | 70      | 39      | 3000     | 10          | 80/320 |
| YT-3922* | 4.0    | 75      | 43      | 2000     | 10          | 80/320 |
| YT-3924* | 4.2    | 75      | 43      | 2000     | 10          | 20/80  |
| YT-3926* | 4.5    | 80      | 47      | 2000     | 10          | 20/80  |
| YT-3928* | 4.8    | 86      | 52      | 2000     | 10          | 20/80  |
| YT-3930* | 5.0    | 86      | 52      | 2000     | 10          | 20/80  |
| YT-3932* | 5.2    | 86      | 52      | 2000     | 10          | 20/80  |
| YT-3935* | 5.5    | 93      | 57      | 2000     | 10          | 20/80  |

| YATO     | Ø (mm) | H1 (mm) | H2 (mm) | RPM.max. | PCS packing | Box    |
|----------|--------|---------|---------|----------|-------------|--------|
| YT-3938* | 6.0    | 93      | 57      | 1500     | 10          | 20/80  |
| YT-3942* | 6.5    | 101     | 63      | 1500     | 10          | 10/40  |
| YT-3944* | 7.0    | 109     | 69      | 1500     | 10          | 10/40  |
| YT-3945* | 7.5    | 109     | 69      | 1500     | 10          | 10/40  |
| YT-3946* | 8.0    | 117     | 75      | 1500     | 10          | 5/20   |
| YT-3949* | 8.5    | 117     | 75      | 1500     | 5           | 10/40  |
| YT-3950* | 9.0    | 125     | 81      | 1000     | 5           | 10/40  |
| YT-3951* | 9.5    | 125     | 81      | 1000     | 5           | 10/40  |
| YT-3952* | 10.0   | 133     | 87      | 1000     | 5           | 10/40  |
| YT-3954* | 10.5   | 133     | 87      | 1000     | 1           | 40/160 |
| YT-3955* | 11.0   | 142     | 94      | 800      | 1           | 40/160 |
| YT-3957* | 12.0   | 151     | 101     | 800      | 1           | 40/160 |
| YT-3958* | 12.5   | 151     | 101     | 800      | 1           | 40/160 |
| YT-3959* | 13.0   | 151     | 101     | 800      | 1           | 40/160 |

| YATO     | Ø (mm) | PCS packing | Box     |
|----------|--------|-------------|---------|
| YT-3970  | 1.0    | 2           | 120/240 |
| YT-3971* | 1.5    | 2           | 120/240 |
| YT-3973  | 2.0    | 2           | 120/240 |
| YT-3976* | 2.5    | 2           | 120/240 |
| YT-3978  | 3.0    | 2           | 120/240 |
| YT-3980  | 3.5    | 1           | 120/240 |
| YT-3982  | 4.0    | 1           | 120/240 |
| YT-3984  | 4.5    | 1           | 120/240 |
| YT-3986  | 5.0    | 1           | 120/240 |
| YT-3988* | 5.5    | 1           | 120/240 |
| YT-3989  | 6.0    | 1           | 120/240 |
| YT-3990  | 6.5    | 1           | 30/120  |
| YT-3992* | 7.0    | 1           | 60/120  |
| YT-3993* | 7.5    | 1           | 60/120  |
| YT-3994  | 8.0    | 1           | 60/120  |
| YT-3996* | 8.5    | 1           | 60/120  |
| YT-3997* | 9.0    | 1           | 60/120  |
| YT-3998* | 9.5    | 1           | 60/120  |
| YT-3999* | 10.0   | 1           | 60/120  |
| YT-4000* | 10.5   | 1           | 60/120  |
| YT-4001* | 11.0   | 1           | 60/120  |
| YT-4003* | 12.0   | 1           | 50      |
| YT-4005* | 13.0   | 1           | 50      |

GB Twist drill set  
 D Metallspiralbohrersatz  
 PL Komplet szlifowanych wiertel do metalu  
 RUS Набор сверл по металлу

CZ Souprava vrtáků na kov  
 H Fúrószerkészlet fémhez  
 RO Set de burghie pt. metal  
 E Broca para metal



6 PCS

Ø mm 2-8

PLASTIC HANGING BOX

10 PCS

Ø mm 1-10

PLASTIC HANGING BOX

19 PCS

Ø mm 1-10

PLASTIC HANGING BOX

| YATO     | Ø (mm)           | Box   |
|----------|------------------|-------|
| YT-4007* | 2; 3; 4; 5; 6; 8 | 15/60 |

| YATO     | Ø (mm)                        | Box   |
|----------|-------------------------------|-------|
| YT-4008* | 1; 2; 3; 4; 5; 6; 7; 8; 9; 10 | 20/40 |

| YATO     | Ø (mm)   | Box   |
|----------|--|-------|
| YT-4009* | 1.0; 1.5; 2.0; 2.5; 3.0; 3.5; 4.0; 4.5; 5.0; 5.5; 6.0; 6.5; 7.0; 7.5; 8.0; 8.5; 9.0; 9.5; 10.0 | 15/30 |

\* - product not for european market  
 \* - produkt nieprzeznaczony na rynek europejski

GB Twist drill HSS-COBALT CZ Vrták na kov HSS-COBALT  
 D Metalspiralbohrer HSS-COBALT H Fúrószerű fémhez HSS-COBALT  
 PL Wiertło do metalu HSS-COBALT RO Burghiu pt. metal HSS-COBALT  
 RUS Сверло по металлу HSS-COBALT E Broca para metal HSS-COBALT

|                    |   |                                     |
|--------------------|---|-------------------------------------|
| <b>DIN</b><br>338  | <b>HSS-E Co HS6-5-2-5</b><br>(PN-EN ISO 4957:2002(U)) | <b>Rm</b><br>>900 N/mm <sup>2</sup> |
|                    |   |                                     |
| <b>SPLIT POINT</b> |   |                                     |

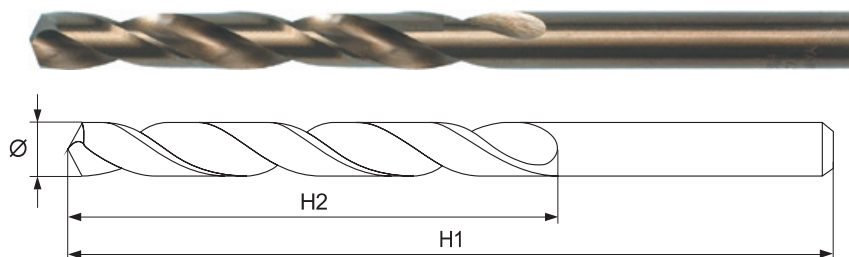

- application: industry
- for precise drilling in hard steels, non-ferrous metals, plastics, stainless steel and acid resistant steel
- resistant to high temperatures

- przeznaczenie: przemysł
- do precyzyjnych wierceń w trudnych materiałach, np. stalach szlachetnych, metalach kolorowych, tworzywach, stalach nierdzewnych i kwasoodpornych
- odporne na działanie wysokiej temperatury

| YATO     | Ø (mm) | H1 (mm) | H2 (mm) | PCS packing: |         |
|----------|--------|---------|---------|--------------|---------|
| YT-4010* | 1.0    | 34      | 12      | 2            | 125/500 |
| YT-4015* | 1.5    | 40      | 18      | 2            | 125/500 |
| YT-4020  | 2.0    | 49      | 24      | 2            | 125/500 |
| YT-4025  | 2.5    | 57      | 30      | 2            | 125/500 |
| YT-4030  | 3.0    | 61      | 33      | 2            | 125/500 |
| YT-4032  | 3.2    | 65      | 36      | 1            | 100/400 |
| YT-4035  | 3.5    | 70      | 39      | 1            | 100/400 |
| YT-4040  | 4.0    | 75      | 43      | 1            | 100/400 |
| YT-4042  | 4.2    | 75      | 43      | 1            | 100/400 |

| YATO    | Ø (mm) | H1 (mm) | H2 (mm) | PCS packing: |         |
|---------|--------|---------|---------|--------------|---------|
| YT-4045 | 4.5    | 80      | 47      | 1            | 100/400 |
| YT-4048 | 4.8    | 86      | 52      | 1            | 100/400 |
| YT-4050 | 5.0    | 86      | 52      | 1            | 100/400 |
| YT-4052 | 5.2    | 86      | 52      | 1            | 100/400 |
| YT-4055 | 5.5    | 93      | 57      | 1            | 100/400 |
| YT-4060 | 6.0    | 93      | 57      | 1            | 100/400 |
| YT-4065 | 6.5    | 101     | 63      | 1            | 75/300  |
| YT-4070 | 7.0    | 109     | 69      | 1            | 75/300  |
| YT-4075 | 7.5    | 109     | 69      | 1            | 75/300  |

\* - product not for european market  
 \* - produkt nieprzeznaczony na rynek europejski

BLISTER  
IN CARD

| YATO    | Ø (mm) | H1 (mm) | H2 (mm) | PCS packing: |        |
|---------|--------|---------|---------|--------------|--------|
| YT-4080 | 8.0    | 117     | 75      | 1            | 75/300 |
| YT-4085 | 8.5    | 117     | 75      | 1            | 75/300 |
| YT-4090 | 9.0    | 125     | 81      | 1            | 75/300 |
| YT-4100 | 10.0   | 133     | 87      | 1            | 75/300 |
| YT-4110 | 11.0   | 142     | 94      | 1            | 75/300 |
| YT-4120 | 12.0   | 151     | 101     | 1            | 75/300 |
| YT-4140 | 14.0   | 160     | 108     | 1            | 25/100 |
| YT-4160 | 16.0   | 178     | 120     | 1            | 25/100 |

GB Masonry drill bit X-TIP CZ Vrták na beton X-TIP RO Burghiu pt. beton X-TIP  
 D Betonspiralbohrer X-TIP H Fúrószerű betonhoz X-TIP  
 PL Wiertło do betonu X-TIP E Broca para hormigón X-TIP

**SDS PLUS** **X-TIP YG-11C**

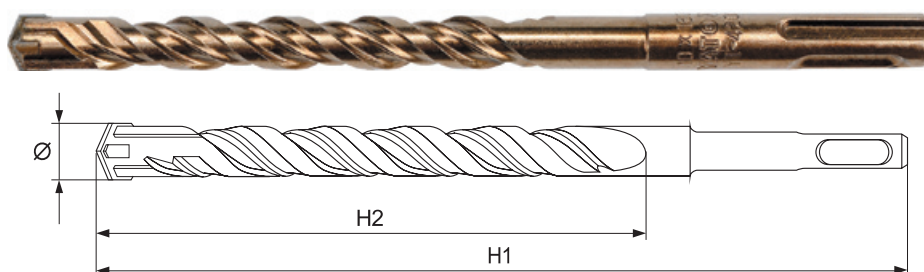

| YATO    | Ø (mm) | H1 (mm) | H2 (mm) | PCS packing: |     |
|---------|--------|---------|---------|--------------|-----|
| YT-4200 | 5      | 110     | 45      | 10           | 300 |
| YT-4201 | 6      | 110     | 45      | 10           | 300 |
| YT-4202 | 6      | 160     | 95      | 10           | 200 |
| YT-4203 | 6      | 210     | 135     | 10           | 150 |
| YT-4204 | 8      | 110     | 45      | 10           | 300 |
| YT-4205 | 8      | 160     | 95      | 10           | 200 |
| YT-4206 | 8      | 210     | 140     | 10           | 150 |
| YT-4207 | 8      | 460     | 370     | 10           | 50  |
| YT-4208 | 8      | 600     | 500     | 10           | 50  |
| YT-4209 | 10     | 160     | 95      | 10           | 150 |
| YT-4210 | 10     | 210     | 140     | 10           | 150 |

| YATO    | Ø (mm) | H1 (mm) | H2 (mm) | PCS packing: |     |
|---------|--------|---------|---------|--------------|-----|
| YT-4211 | 10     | 300     | 220     | 10           | 100 |
| YT-4212 | 10     | 460     | 370     | 10           | 50  |
| YT-4213 | 10     | 600     | 500     | 10           | 50  |
| YT-4214 | 12     | 160     | 95      | 10           | 150 |
| YT-4215 | 12     | 260     | 185     | 10           | 100 |
| YT-4216 | 12     | 460     | 360     | 10           | 50  |
| YT-4217 | 12     | 600     | 490     | 10           | 40  |
| YT-4218 | 14     | 260     | 180     | 10           | 80  |
| YT-4219 | 14     | 460     | 360     | 10           | 40  |
| YT-4220 | 16     | 200     | 125     | 10           | 60  |
| YT-4221 | 16     | 460     | 360     | 10           | 20  |

| YATO    | Ø (mm) | H1 (mm) | H2 (mm) | PCS packing: |    |
|---------|--------|---------|---------|--------------|----|
| YT-4222 | 16     | 600     | 490     | 10           | 20 |
| YT-4223 | 18     | 460     | 360     | 10           | 20 |
| YT-4224 | 18     | 600     | 490     | 10           | 20 |
| YT-4225 | 20     | 460     | 360     | 5            | 20 |
| YT-4226 | 20     | 600     | 490     | 5            | 20 |
| YT-4227 | 22     | 460     | 360     | 5            | 20 |
| YT-4228 | 22     | 600     | 490     | 5            | 20 |
| YT-4229 | 25     | 460     | 360     | 5            | 20 |
| YT-4230 | 25     | 600     | 490     | 5            | 10 |

PLASTIC TUBE  
& PLASTIC HANGER

GB Masonry drill bit  
D Betonspiralbohrer  
PL Wiertło do betonu

RUS Сверло по бетону  
CZ Vrták na beton  
H Fúrószár betonhoz

RO Burghiu pt. beton  
E Broca para hormigón

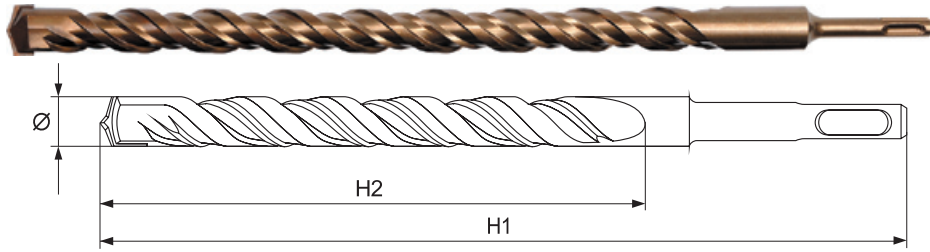

PLASTIC TUBE & PLASTIC HANGER

| YATO    | Ø (mm) | H1 (mm) | H2 (mm) | PCS packing: | Box |
|---------|--------|---------|---------|--------------|-----|
| YT-4161 | 5      | 110     | 45      | 10           | 300 |
| YT-4162 | 6      | 110     | 45      | 10           | 300 |
| YT-4163 | 6      | 160     | 95      | 10           | 200 |
| YT-4164 | 6      | 210     | 140     | 10           | 150 |
| YT-4165 | 8      | 110     | 45      | 10           | 300 |
| YT-4166 | 8      | 160     | 90      | 10           | 200 |
| YT-4167 | 8      | 210     | 140     | 10           | 150 |
| YT-4168 | 8      | 460     | 370     | 10           | 50  |
| YT-4169 | 8      | 600     | 500     | 10           | 50  |
| YT-4170 | 10     | 160     | 95      | 10           | 150 |
| YT-4171 | 10     | 210     | 140     | 10           | 150 |

| YATO    | Ø (mm) | H1 (mm) | H2 (mm) | PCS packing: | Box |
|---------|--------|---------|---------|--------------|-----|
| YT-4172 | 10     | 300     | 220     | 10           | 100 |
| YT-4173 | 10     | 460     | 370     | 10           | 50  |
| YT-4174 | 10     | 600     | 500     | 10           | 50  |
| YT-4175 | 12     | 160     | 85      | 10           | 150 |
| YT-4176 | 12     | 260     | 180     | 10           | 100 |
| YT-4177 | 12     | 460     | 360     | 10           | 50  |
| YT-4178 | 12     | 600     | 490     | 10           | 40  |
| YT-4179 | 14     | 260     | 180     | 10           | 80  |
| YT-4180 | 14     | 460     | 360     | 10           | 40  |
| YT-4181 | 16     | 200     | 125     | 10           | 60  |
| YT-4182 | 16     | 300     | 220     | 10           | 50  |

| YATO    | Ø (mm) | H1 (mm) | H2 (mm) | PCS packing: | Box |
|---------|--------|---------|---------|--------------|-----|
| YT-4183 | 16     | 460     | 360     | 10           | 20  |
| YT-4184 | 16     | 600     | 490     | 10           | 20  |
| YT-4185 | 18     | 460     | 360     | 10           | 20  |
| YT-4186 | 18     | 600     | 490     | 10           | 20  |
| YT-4187 | 20     | 460     | 360     | 5            | 20  |
| YT-4188 | 20     | 600     | 490     | 5            | 20  |
| YT-4189 | 22     | 460     | 360     | 5            | 20  |
| YT-4190 | 22     | 600     | 490     | 5            | 20  |
| YT-4191 | 25     | 460     | 360     | 5            | 20  |
| YT-4192 | 25     | 600     | 490     | 5            | 10  |

GB Masonry drill bit  
D Betonspiralbohrer  
PL Wiertło do betonu  
RUS Сверло по бетону

CZ Vrták na beton  
H Fúrószár betonhoz  
RO Burghiu pt. beton  
E Broca para hormigón

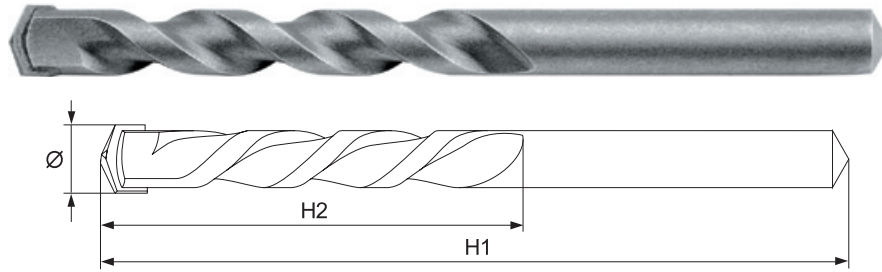
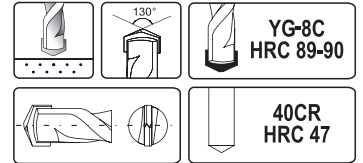

BLISTER IN CARD

| YATO    | Ø (mm) | H1 (mm) | H2 (mm) | Box     |
|---------|--------|---------|---------|---------|
| YT-4361 | 4      | 70      | 35      | 100/400 |
| YT-4362 | 5      | 90      | 50      | 100/400 |
| YT-4363 | 6      | 100     | 60      | 100/400 |
| YT-4364 | 6      | 150     | 100     | 100/400 |
| YT-4367 | 7      | 100     | 60      | 75/300  |
| YT-4369 | 8      | 120     | 80      | 75/300  |
| YT-4370 | 8      | 200     | 140     | 50/150  |

| YATO    | Ø (mm) | H1 (mm) | H2 (mm) | Box    |
|---------|--------|---------|---------|--------|
| YT-4373 | 9      | 120     | 80      | 75/300 |
| YT-4375 | 10     | 120     | 80      | 75/300 |
| YT-4376 | 10     | 200     | 140     | 50/150 |
| YT-4379 | 12     | 150     | 100     | 50/150 |
| YT-4380 | 12     | 200     | 140     | 50/150 |
| YT-4383 | 14     | 180     | 120     | 25/100 |
| YT-4385 | 16     | 180     | 120     | 25/100 |

GB Masonry drill bit set  
D Betonspiralbohrersatz  
PL Komplet wiertło do betonu  
RUS Сверла по бетону в наборе  
CZ Souprava vrtáků do betonu  
H Fúrószárkészlet betonhoz  
RO Set de burghie pt. beton  
E Brocas para hormigón

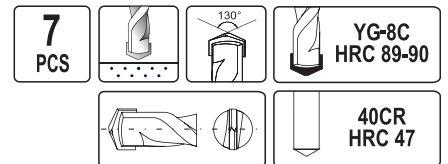

PLASTIC HANGING BOX

| YATO    | Ø (mm)                | Box   |
|---------|-----------------------|-------|
| YT-4390 | 4; 5; 6; 8; 9; 10; 12 | 10/80 |

GB Flat wood drill bit  
D Schaufelbohrer  
PL Wiertło łopatkowe  
do drewna

RUS Перовые сверла  
CZ Plochý vrták  
H Homlokmarós fúró

RO Burghiu plate  
E Broca de aletas

DOUBLE  
BLISTER

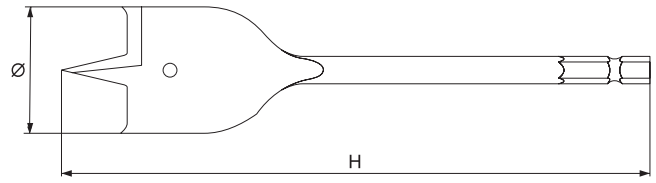

| YATO    | Ø (mm) | H (mm) |        |
|---------|--------|--------|--------|
| YT-3236 | 6      | 152    | 50/400 |
| YT-3237 | 8      | 152    | 50/400 |
| YT-3238 | 10     | 152    | 50/300 |
| YT-3239 | 12     | 152    | 50/300 |
| YT-3240 | 13     | 152    | 50/300 |
| YT-3241 | 14     | 152    | 50/300 |
| YT-3242 | 16     | 152    | 50/300 |
| YT-3243 | 18     | 152    | 50/300 |
| YT-3244 | 20     | 152    | 50/300 |
| YT-3245 | 22     | 152    | 50/300 |

| YATO    | Ø (mm) | H (mm) |        |
|---------|--------|--------|--------|
| YT-3246 | 24     | 152    | 50/300 |
| YT-3247 | 25     | 152    | 50/300 |
| YT-3248 | 26     | 152    | 50/300 |
| YT-3249 | 28     | 152    | 50/300 |
| YT-3250 | 30     | 152    | 50/200 |
| YT-3251 | 32     | 152    | 50/200 |
| YT-3252 | 34     | 152    | 50/200 |
| YT-3253 | 35     | 152    | 50/200 |
| YT-3254 | 38     | 152    | 50/200 |
| YT-3255 | 40     | 152    | 50/200 |

GB Extension for flat wood drill bits  
D Verlängerung für Schaufelbohrer  
PL Przedłużka do wiertel łopatkowych  
RUS Удлинитель для перовых сверл  
CZ Nástavec pro ploché vrtáky  
H Hosszabbító homlokmarós fafúrókhoz  
RO Prelungitor pt. burghie plate  
E Extensión para brocas de aletas

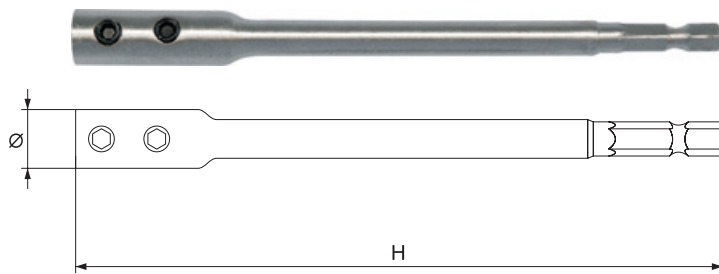

1/4"  
(6,3mm)



| YATO    | Ø (mm) | H (mm) |        |
|---------|--------|--------|--------|
| YT-3256 | 12.2   | 150    | 60/120 |
| YT-3257 | 13.5   | 300    | 30/60  |

GB Flat wood drill bit set  
D Schaufelbohrersatz  
PL Zestaw wiertel łopatkowych  
RUS Набор перовых сверл

CZ Sada ploché vrtáků  
H Homlokmarós fafúró készlet  
RO Set burghie plate  
E Juego de brocas de aletas

6  
PCS

1/4"  
(6,3mm)

GB Flat wood drill bit set  
D Schaufelbohrersatz  
PL Zestaw wiertel łopatkowych  
RUS Набор перовых сверл

CZ Sada ploché vrtáků  
H Homlokmarós fafúró készlet  
RO Set burghie plate  
E Juego de brocas de aletas

8  
PCS

1/4"  
(6,3mm)



POUCH



| YATO    | Ø (mm)                 | H (mm) |       |
|---------|------------------------|--------|-------|
| YT-3258 | 10; 12; 16; 18; 20; 25 | 152    | 25/50 |



PLASTIC  
CASE  
& DOUBLE  
BLISTER



| YATO    | Ø (mm)                         | H (mm) |      |
|---------|--------------------------------|--------|------|
| YT-3259 | 12; 16; 18; 20; 22; 25; 28; 32 | 152    | 5/20 |

GB Spur wood drill bit  
D Spiralbohrer für Holz  
PL Wiertło do drewna spiralne

RUS Спиральное сверло по дереву  
CZ Vrták do dřeva spirálový  
H Csigafúró fához

RO Burghiu spirală pt. lemn  
E Barrena para madera espiral

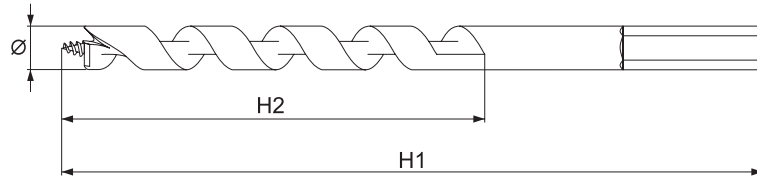

DOUBLE BLISTER

| YATO    | Ø (mm) | H1 (mm) | H2 (mm) | Box    |
|---------|--------|---------|---------|--------|
| YT-4350 | 3      | 60      | 35      | 30/300 |
| YT-4351 | 4      | 75      | 44      | 30/300 |
| YT-4352 | 5      | 85      | 52      | 30/300 |
| YT-4353 | 6      | 90      | 57      | 30/300 |
| YT-4354 | 7      | 100     | 67      | 30/300 |

| YATO    | Ø (mm) | H1 (mm) | H2 (mm) | Box    |
|---------|--------|---------|---------|--------|
| YT-4355 | 8      | 110     | 75      | 30/300 |
| YT-4356 | 10     | 120     | 77      | 30/300 |
| YT-4357 | 12     | 150     | 97      | 15/120 |
| YT-4358 | 13     | 150     | 102     | 15/120 |
| YT-4359 | 16     | 180     | 120     | 15/120 |

GB Auger wood drill bit  
D Holzbohrer  
PL Świdler do drewna

RUS Бур по дереву  
CZ Vrták do dřeva hadovitý  
H Fafúró

RO Burghiu elicoidal pt. lemn  
E Barrena para madera



13mm

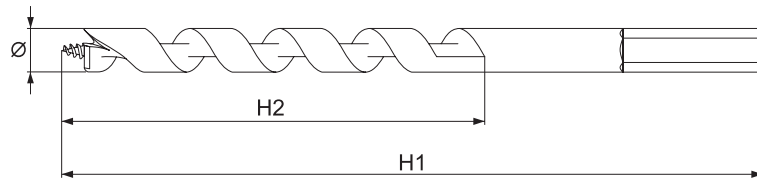

DOUBLE BLISTER

| YATO    | Ø (mm) | H1 (mm) | H1 (mm) | Box    |
|---------|--------|---------|---------|--------|
| YT-3261 | 6      | 191     | 121     | 60/360 |
| YT-3262 | 8      | 191     | 121     | 70/280 |
| YT-3263 | 8      | 400     | 310     | 60/120 |
| YT-3264 | 10     | 191     | 121     | 50/200 |
| YT-3265 | 10     | 400     | 310     | 50/100 |
| YT-3266 | 12     | 191     | 121     | 50/150 |
| YT-3267 | 12     | 400     | 310     | 20/60  |
| YT-3268 | 13     | 191     | 121     | 50/100 |
| YT-3269 | 13     | 400     | 310     | 20/60  |
| YT-3270 | 14     | 191     | 121     | 50/100 |
| YT-3271 | 14     | 400     | 310     | 20/60  |
| YT-3272 | 16     | 191     | 121     | 50/100 |
| YT-3273 | 16     | 400     | 310     | 20/40  |

| YATO    | Ø (mm) | H1 (mm) | H1 (mm) | Box   |
|---------|--------|---------|---------|-------|
| YT-3274 | 18     | 215     | 142     | 40/80 |
| YT-3275 | 18     | 400     | 310     | 20/40 |
| YT-3276 | 20     | 215     | 145     | 20/60 |
| YT-3277 | 20     | 400     | 310     | 20/40 |
| YT-3278 | 22     | 215     | 145     | 20/60 |
| YT-3279 | 22     | 400     | 310     | 10/30 |
| YT-3280 | 24     | 215     | 145     | 20/60 |
| YT-3281 | 24     | 400     | 310     | 6/30  |
| YT-3282 | 25     | 215     | 145     | 20/40 |
| YT-3283 | 25     | 400     | 310     | 5/25  |
| YT-3284 | 26     | 215     | 145     | 10/40 |
| YT-3285 | 26     | 400     | 310     | 10/20 |
| YT-3286 | 28     | 240     | 145     | 9/36  |

| YATO    | Ø (mm) | H1 (mm) | H1 (mm) | Box   |
|---------|--------|---------|---------|-------|
| YT-3287 | 28     | 400     | 310     | 5/20  |
| YT-3288 | 30     | 240     | 170     | 10/30 |
| YT-3289 | 30     | 400     | 310     | 5/10  |
| YT-3290 | 32     | 240     | 170     | 5/25  |
| YT-3291 | 32     | 400     | 310     | 5/15  |
| YT-3292 | 35     | 240     | 170     | 5/20  |
| YT-3293 | 35     | 400     | 310     | 5/10  |
| YT-3294 | 36     | 240     | 170     | 10/20 |
| YT-3295 | 36     | 400     | 310     | 5/10  |
| YT-3296 | 38     | 240     | 170     | 5/15  |
| YT-3297 | 40     | 240     | 170     | 5/15  |

GB Auger wood drill bit set  
D Holzbohrersatz  
PL Zestaw świdrów do drewna  
RUS Набор буров по дереву  
CZ Sada hadovitých vrtáků do dřeva  
H Fafúró készlet  
RO Set de burghie elicoidale pt. lemn  
E Juego de barrenas para madera



WOOD CASE & COLOR BOX

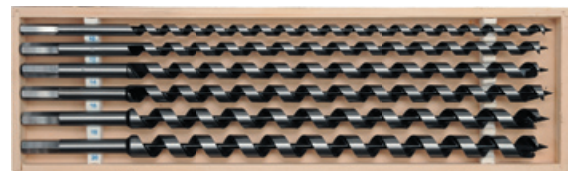

| 6 PCS | 13mm | YATO    | Ø (mm)                 | H (mm) | Box |
|-------|------|---------|------------------------|--------|-----|
|       |      | YT-3299 | 10; 12; 14; 16; 18; 20 | 460    | 8   |

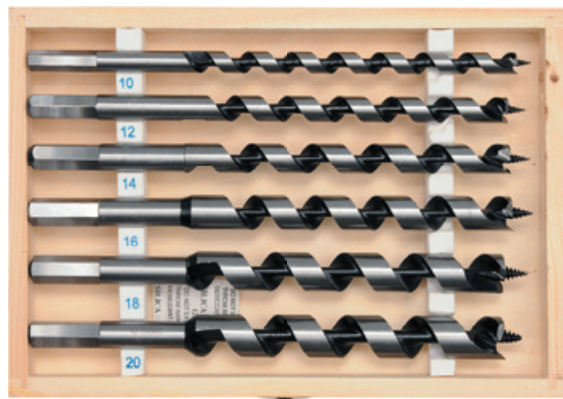

| 6 PCS | 13mm | YATO    | Ø (mm)                 | H (mm) | Box |
|-------|------|---------|------------------------|--------|-----|
|       |      | YT-3298 | 10; 12; 14; 16; 18; 20 | 230    | 15  |

| 6 PCS | SDS PLUS | YATO    | Ø (mm)                 | H (mm) | Box |
|-------|----------|---------|------------------------|--------|-----|
|       |          | YT-3300 | 10; 12; 14; 16; 18; 20 | 200    | 20  |



GB Drill for glass  
D Bohrer für Glas  
PL Wiertło do szkła  
RUS Сверло по стеклу  
CZ Vrták do skla  
H Üvegfüró  
RO Burghiu pt. sticlă  
E Broca para vidrio

YG6X  
HRA  
90



SLIDING  
CARD

| YATO    | Ø (mm) |         | YATO    | Ø (mm) |         |
|---------|--------|---------|---------|--------|---------|
| YT-3725 | 4      | 100/400 | YT-3727 | 8      | 100/400 |
| YT-3726 | 6      | 100/400 | YT-3728 | 10     | 50/200  |

GB Adjustable hand reamer  
D Verstellbare Reibahle  
PL Rozwiertak nastawny  
RUS Регулируемая развертка  
CZ Nastavitelný výstružník  
H Állítható dörzsár  
RO Alezor reglabil  
E Escariador ajustable

HSS  
4241



PLASTIC  
TUBE

| YATO     | working diameter /<br>średnica robocza (mm²) | L (mm) | arbor diameter /<br>średnica trzpienia (mm²) |        | YATO     | working diameter /<br>średnica robocza (mm²) | L (mm) | arbor diameter /<br>średnica trzpienia (mm²) |       |
|----------|--|--------|--|--------|----------|--|--------|--|-------|
| YT-28950 | 7.75-8.5                                     | 107    | 4.5  | 50/200 | YT-28959 | 17-19  | 175    | 10.0   | 20/60 |
| YT-28951 | 8.5-9.25                                     | 112    | 4.5  | 50/200 | YT-28960 | 19-21  | 180    | 11.5   | 20/60 |
| YT-28952 | 9.25-10                                      | 116    | 5.0  | 50/200 | YT-28961 | 21-23  | 193    | 13.5   | 20/40 |
| YT-28953 | 10-10.75                                     | 125    | 5.5  | 50/200 | YT-28962 | 23-26  | 210    | 15.4   | 4/20  |
| YT-28954 | 10.75-11.75                                  | 130    | 6.5  | 50/200 | YT-28963 | 26-29.5                                      | 245    | 17.0   | 4/20  |
| YT-28955 | 11.75-12.75                                  | 135    | 7.5  | 50/150 | YT-28964 | 29.5-33.5                                    | 270    | 19.0   | 4/12  |
| YT-28956 | 12.75-13.75                                  | 140    | 7.5  | 50/150 | YT-28965 | 33.5-38                                      | 310    | 21.0   | 2/10  |
| YT-28957 | 13.75-15.25                                  | 158    | 8.0  | 20/60  | YT-28966 | 38-44  | 345    | 24.0   | 2/10  |
| YT-28958 | 15.25-17                                     | 165    | 9.0  | 20/60  | YT-28967 | 44-54  | 400    | 30.0   | 5     |

GB Point chisel SDS+      RUS Зубило SDS+      RO Punctator SDS+  
D Spitzmeißel SDS+      CZ Sekáč špičák SDS+      E Cincel puntiagudo SDS+  
PL Przecinak SDS+      H Hegyes véső SDS+

4x14  
x250  
mm      SDS  
PLUS      CrV



PLASTIC  
HANGER



| YATO    | L (mm) |      |
|---------|--------|------|
| YT-4720 | 250    | 6/48 |

GB Flat chisel SDS+      RUS Долото узкое SDS+      RO Punctator pt. adancit SDS+  
D Flachmeißel SDS+      CZ Sekáč plochý SDS+      E Cincel plano estrecho SDS+  
PL Dłuto wąskie SDS+      H Lapos véső SDS+

20x14  
x250  
mm      SDS  
PLUS      CrV



PLASTIC  
HANGER



| YATO    | L (mm) |      |
|---------|--------|------|
| YT-4721 | 250    | 6/48 |

GB Hollow chisel SDS+      RUS Бороздник SDS+      RO Punctator pt. adancit SDS+  
D Nutenmeißel SDS+      CZ Sekáč drážkovací SDS+      E Cincel acanalado SDS+  
PL Bruzdownik SDS+      H Horonyvėső SDS+

22x18  
x250  
mm      SDS  
PLUS      CrV



PLASTIC  
HANGER



| YATO    | L (mm) |      |
|---------|--------|------|
| YT-4722 | 250    | 6/48 |

GB Flat chisel SDS+      RUS Долото плоское SDS+      RO Punctator tip dalta SDS+  
D Spatmeißel SDS+      CZ Sekáč plochý SDS+      E Cincel plano SDS+  
PL Dłuto płaskie SDS+      H Széles lapos véső SDS+

40x14  
x250  
mm      SDS  
PLUS      CrV



PLASTIC  
HANGER



| YATO    | L (mm) |      |
|---------|--------|------|
| YT-4723 | 250    | 6/48 |

GB Hollow drill set H Koronafúró falhoz  
 D Bohrkrona RO Burghiu cu coroană  
 PL Wiertło koronowe do betonu pt. beton  
 RUS Свёрла по бетону корончатые E Broca widia para muro  
 CZ Korunový vrták na zed'

COLOR BOX

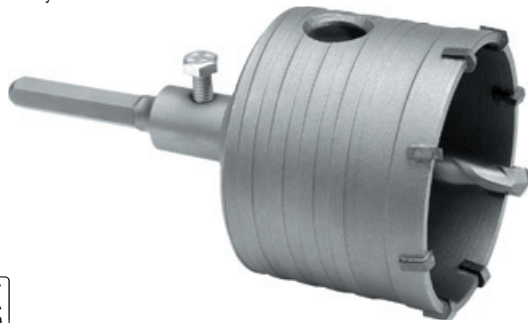

**HEX**  
12mm

**SDS PLUS**

| YATO    | Ø (mm) | TCT | Box |
|---------|--------|-----|-----|
| YT-4400 | 65     | 6   | 24  |
| YT-4401 | 80     | 8   | 20  |

| YATO    | Ø (mm) | TCT | Box |
|---------|--------|-----|-----|
| YT-4402 | 65     | 6   | 24  |
| YT-4403 | 80     | 8   | 20  |

GB Bi-metal hole saw  
 D Bimetall-Lochsäge  
 PL Otwornica bimetalowa  
 RUS Ножовка к отверстиям би-металлическая  
 CZ Vrtací korunka bimetalová  
 H Bi-metál koronafúró  
 RO Găurătorii bimetalici  
 E Sierra de marquetería bi-metálica

- application: industry
- to drill holes in stainless steels, cast steels, aluminium, wood, plastics
- cutting depth: 40 mm
- przeznaczenie: przemysł
- do wycinania otworów w stalach nierdzewnych, żelazie, aluminium, drewnie, tworzywach sztucznych
- głębokość cięcia: 40 mm

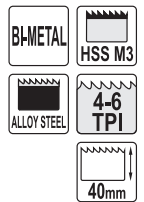
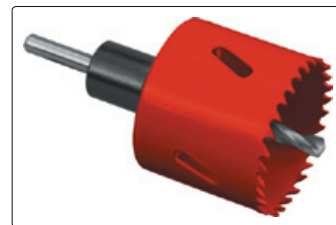

PLASTIC HANGER

| YATO    | Ø (mm) | thread / gwint | Box    |
|---------|--------|----------------|--------|
| YT-3303 | 19     | 1/2" (12.5 mm) | 25/100 |
| YT-3304 | 20     | 1/2" (12.5 mm) | 25/100 |
| YT-3306 | 22     | 1/2" (12.5 mm) | 25/100 |
| YT-3308 | 25     | 1/2" (12.5 mm) | 25/100 |
| YT-3311 | 29     | 1/2" (12.5 mm) | 25/100 |
| YT-3313 | 32     | 5/8" (16 mm)   | 25/100 |
| YT-3315 | 35     | 5/8" (16 mm)   | 25/100 |
| YT-3317 | 38     | 5/8" (16 mm)   | 25/100 |
| YT-3318 | 40     | 5/8" (16 mm)   | 25/100 |
| YT-3321 | 44     | 5/8" (16 mm)   | 25/100 |

| YATO    | Ø (mm) | thread / gwint | Box    |
|---------|--------|----------------|--------|
| YT-3322 | 46     | 5/8" (16 mm)   | 25/100 |
| YT-3323 | 48     | 5/8" (16 mm)   | 25/100 |
| YT-3324 | 51     | 5/8" (16 mm)   | 25/100 |
| YT-3327 | 57     | 5/8" (16 mm)   | 25/50  |
| YT-3329 | 60     | 5/8" (16 mm)   | 25/50  |
| YT-3330 | 64     | 5/8" (16 mm)   | 25/50  |
| YT-3332 | 67     | 5/8" (16 mm)   | 25/50  |
| YT-3333 | 68     | 5/8" (16 mm)   | 25/50  |
| YT-3334 | 70     | 5/8" (16 mm)   | 25/50  |
| YT-3336 | 76     | 5/8" (16 mm)   | 25/50  |

| YATO    | Ø (mm) | thread / gwint | Box   |
|---------|--------|----------------|-------|
| YT-3338 | 83     | 5/8" (16 mm)   | 25/50 |
| YT-3343 | 95     | 5/8" (16 mm)   | 25/50 |
| YT-3345 | 102    | 5/8" (16 mm)   | 10/20 |
| YT-3346 | 105    | 5/8" (16 mm)   | 10/20 |
| YT-3349 | 114    | 5/8" (16 mm)   | 10/20 |
| YT-3350 | 121    | 5/8" (16 mm)   | 10/20 |
| YT-3351 | 127    | 5/8" (16 mm)   | 10/20 |
| YT-3353 | 140    | 5/8" (16 mm)   | 10/20 |

GB Arbor for hole saw  
 D Halterung für Lochsägen  
 PL Uchwyt do otwornic  
 RUS Рукоятка к ножовке

CZ Šroubový unášec pro vrtací korunky  
 H Befogószár a koronafúróhoz  
 RO Dispozitiv de antrenare pt. găurătorii bimetalici

E Mango para las sierras de marquetería

**HEX** **SDS PLUS**



| YATO    | SDS+ / HEX        | Box    |
|---------|-------------------|--------|
| YT-3370 | HEX 7/16" (11 mm) | 25/100 |
| YT-3373 | SDS+              | 25/100 |

| YATO    | SDS+ / HEX        | Box    |
|---------|-------------------|--------|
| YT-3371 | HEX 7/16" (11 mm) | 25/100 |
| YT-3372 | HEX 7/16" (11 mm) | 25/50  |
| YT-3374 | SDS+              | 25/50  |

GB Pilot drill RUS Свёрло пилот RO Burghiu pilot  
 D Pilotbohrer CZ Sříedící vrták E Broca piloto  
 PL Wiertło pilot H Központfúró

**HSS**



| YATO    | Ø (mm) | H (mm) | Box    |
|---------|--------|--------|--------|
| YT-3376 | 6.0    | 75     | 25/100 |

| YATO    | Ø (mm) | H (mm) | Box    |
|---------|--------|--------|--------|
| YT-3377 | 6.0    | 100    | 25/100 |

- GB Electrician's hole saw kit  
D Lochsägensatz für Elektriker  
PL Zestaw otwornic dla elektryków  
RUS Набор ножовок к отверстиям для электриков  
CZ Sada vrtacích korunek pro elektřikáře  
H Koronafúró készlet villanyszerelőknek  
RO Set de găuritori pt. electricieni  
E Juego de sierras de marquetería para electricistas

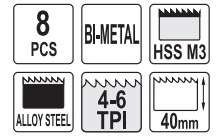

BMC & COLOR SLEEVE

| YATO    | Ø (mm)                 |    |
|---------|------------------------|----|
| YT-3380 | 22; 29; 35; 44; 67; 73 | 10 |

- GB Combination hole saw kit  
D Universal-Lochsägensatz  
PL Uniwersalny zestaw otwornic  
RUS Универсальный набор ножовок к отверстиям  
CZ Univerzální sada vrtacích korunek  
H Univerzális koronafúró készlet  
RO Set univesal de găuritori  
E Juego universal de sierras de marquetería

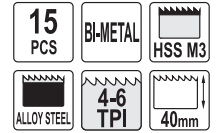

BMC & COLOR SLEEVE

| YATO    | Ø (mm)                                     |   |
|---------|--|---|
| YT-3381 | 19; 22; 25; 32; 35; 38; 44; 51; 57; 64; 76 | 5 |

- GB Automotive hole saw kit  
D Lochsägensatz für die Kraftfahrzeugtechnik  
PL Zestaw otwornic dla motoryzacji  
RUS Автомобильный набор ножовок к отверстиям  
CZ Sada vrtacích korunek pro automobilizmus  
H Koronafúró készlet az autópár számára  
RO Set de găuritori pt. motorizare  
E Juego de sierras de marquetería para la industria automotriz

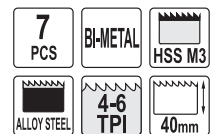

BMC & COLOR SLEEVE

| YATO    | Ø (mm)             |    |
|---------|--------------------|----|
| YT-3382 | 19; 22; 25; 29; 32 | 20 |

GB Hand tap  
 D Handgewindebohrer  
 PL Gwintownik ręczny  
 RUS Ручный метчик  
 CZ Závrtník  
 H Menetfúró  
 RO Tarozí  
 E Machos de roscar



SLIDING CARD



**3**  
PCS

**DIN 352**

**HSS M2**

**3-STAGE TAPPING**  
GWINTOWANIE 3-STOPNIOWE

**METRIC COARSE**  
GWINT METRYCZNY GRUBOZWOJNY

| YATO    | size x pitch<br>rozmiar x skok gwintu | thread length (mm)<br>długość gwintu (mm) | L (mm) | shank diameter (mm)<br>średnica trzonu (mm) | PCS<br>packing: | weight (g)<br>waga (g) |         |
|---------|---------------------------------------|---|--------|---|-----------------|------------------------|---------|
| YT-2930 | M3x0.5                                | 11  | 40     | 3.5   | 3               | 25                     | 100/400 |
| YT-2931 | M4x0.7                                | 13  | 45     | 4.5   | 3               | 35                     | 50/200  |
| YT-2932 | M5x0.8                                | 16  | 50     | 6.0   | 3               | 45                     | 60/240  |
| YT-2933 | M6x1.0                                | 19  | 50     | 6.0   | 3               | 45                     | 60/240  |
| YT-2934 | M7x1.0                                | 19  | 50     | 6.0   | 3               | 55                     | 75/300  |
| YT-2935 | M8x1.25                               | 22  | 56     | 6.0   | 3               | 60                     | 50/200  |
| YT-2937 | M10x1.5                               | 24  | 70     | 7.0   | 3               | 85                     | 50/200  |
| YT-2939 | M12x1.75                              | 29  | 75     | 9.0   | 3               | 125                    | 50/200  |

| YATO    | size x pitch<br>rozmiar x skok gwintu | thread length (mm)<br>długość gwintu (mm) | L (mm) | shank diameter (mm)<br>średnica trzonu (mm) | PCS<br>packing: | weight (g)<br>waga (g) |       |
|---------|---------------------------------------|---|--------|---|-----------------|------------------------|-------|
| YT-2940 | M14x2.0                               | 30  | 80     | 10.5  | 3               | 200                    | 20/80 |
| YT-2941 | M16x2.0                               | 32  | 80     | 11.0  | 3               | 235                    | 20/80 |
| YT-2942 | M18x2.5                               | 40  | 95     | 12.0  | 3               | 345                    | 20/80 |
| YT-2943 | M20x2.5                               | 40  | 95     | 14.0  | 3               | 445                    | 10/40 |
| YT-2926 | M22x2.5                               | 40  | 100    | 18.0  | 3               | 600                    | 10/40 |
| YT-2927 | M24x3.0                               | 50  | 110    | 18.0  | 3               | 700                    | 15/30 |
| YT-2928 | M27x3.0                               | 50  | 110    | 20.0  | 3               | 950                    | 15/30 |
| YT-2929 | M30x3.5                               | 56  | 125    | 22.0  | 3               | 1100                   | 10/20 |

GB Machine tap  
 D Maschinengewindebohrer  
 PL Gwintownik maszynowy  
 RUS Машинный метчик  
 CZ Strojní závitník

**DIN 371M**

**HSS M2**

**1-STAGE TAPPING**  
GWINTOWANIE 1-STOPNIOWE

**METRIC COARSE**  
GWINT METRYCZNY GRUBOZWOJNY

GB Machine tap  
 D Maschinengewindebohrer  
 PL Gwintownik maszynowy  
 RUS Машинный метчик  
 CZ Strojní závitník

**DIN 376**

**HSS M2**

**1-STAGE TAPPING**  
GWINTOWANIE 1-STOPNIOWE

**METRIC COARSE**  
GWINT METRYCZNY GRUBOZWOJNY



SLIDING CARD



SLIDING CARD



| YATO    | size x pitch<br>rozmiar x skok gwintu | thread length (mm)<br>długość gwintu (mm) | L (mm) | shank diameter (mm)<br>średnica trzonu (mm) | weight (g)<br>waga (g) |         |
|---------|---------------------------------------|---|--------|---|------------------------|---------|
| YT-2950 | M3x0.5                                | 11  | 56     | 3.5   | 15                     | 100/400 |
| YT-2951 | M4x0.7                                | 13  | 63     | 4.5   | 20                     | 100/400 |
| YT-2952 | M5x0.8                                | 16  | 70     | 6.0   | 25                     | 60/240  |
| YT-2953 | M6x1.0                                | 19  | 80     | 6.0   | 30                     | 50/200  |
| YT-2954 | M7x1.0                                | 19  | 80     | 7.1   | 35                     | 30/120  |
| YT-2955 | M8x1.25                               | 22  | 90     | 8.0   | 45                     | 50/200  |
| YT-2956 | M10x1.5                               | 24  | 100    | 10.0  | 65                     | 50/200  |

| YATO    | size x pitch<br>rozmiar x skok gwintu | thread length (mm)<br>długość gwintu (mm) | L (mm) | shank diameter (mm)<br>średnica trzonu (mm) | weight (g)<br>waga (g) |        |
|---------|---------------------------------------|---|--------|---|------------------------|--------|
| YT-2944 | M12x1.75                              | 29  | 110    | 9.0   | 70                     | 25/100 |
| YT-2945 | M14x2.0                               | 30  | 110    | 11.0  | 110                    | 25/100 |
| YT-2946 | M16x2.0                               | 32  | 110    | 12.0  | 120                    | 25/100 |
| YT-2947 | M18x2.5                               | 34  | 125    | 14.0  | 200                    | 25/100 |
| YT-2948 | M20x2.5                               | 34  | 140    | 16.0  | 260                    | 25/100 |
| YT-2949 | M22x2.5                               | 34  | 140    | 18.0  | 340                    | 20/80  |
| YT-2957 | M24x3.0                               | 38  | 160    | 18.0  | 400                    | 15/60  |
| YT-2958 | M27x3.0                               | 38  | 160    | 20.0  | 500                    | 15/60  |
| YT-2959 | M30x3.5                               | 45  | 180    | 22.0  | 700                    | 15/60  |

10

GB Taps and dies set  
 D Gewindeschneidwerkzeug-Satz  
 PL Zestaw narzędzi i gwintowników  
 RUS Набор плашек и метчиков  
 CZ Souprava závitníků  
 a kruhových závitových čelistí  
 H Menetfúró és menetvágó készlet  
 RO Set de tarozí și filiere  
 E Juego de machos de roscar y cojinetes



METAL CASE & COLOR BOX

**HSS**

**44**  
PCS

DIN223  
DIN225  
DIN352  
DIN1814



| YATO    | size / rozmiar               |   |
|---------|------------------------------|---|
| YT-2978 | M3; M4; M5; M6; M8; M10; M12 | 4 |



**32**  
PCS

DIN223  
DIN352

| YATO    | size / rozmiar               |    |
|---------|------------------------------|----|
| YT-2975 | M3; M4; M5; M6; M8; M10; M12 | 10 |

**56**  
PCS

DIN223  
DIN225  
DIN352  
DIN1814



| YATO    | size / rozmiar                                   |   |
|---------|--|---|
| YT-2979 | M3; M4; M5; M6; M8; M10; M12; M14; M16; M18; M20 | 2 |

GB Taps set  
D Gewindeschneidwerkzeug-Satz  
PL Zestaw gwintowników  
RUS Набор метчиков  
CZ Souprava závitníků  
H Menetfűrő készlet  
RO Set de tarozi  
E Juego de machos de roscar



29  
PCS

DIN338  
DIN352  
DIN1814



21  
PCS

DIN  
352

| YATO    | size / rozmiar               |    |
|---------|------------------------------|----|
| YT-2976 | M3; M4; M5; M6; M8; M10; M12 | 20 |

| YATO    | size / rozmiar               |    |
|---------|------------------------------|----|
| YT-2977 | M3; M4; M5; M6; M8; M10; M12 | 12 |

GB Circular die  
D Schneideisen  
PL Narzynka  
RUS Плашка

CZ Kruhov závitov  
čelist  
H Menetvg

RO Filier  
E Cojinete  
de roscar



SLIDING  
CARD



| YATO    | size x pitch<br>rozmiar x skok gwintu | outside diameter (mm)<br>średnica zewnętrzna (mm) | thickness (mm)<br>grubość (mm) | weight (g)<br>waga (g) |         |
|---------|---------------------------------------|---|--------------------------------|------------------------|---------|
| YT-2961 | M4x0.7                                | 20  | 5                              | 20                     | 125/500 |
| YT-2962 | M5x0.8                                | 20  | 7                              | 20                     | 100/400 |
| YT-2963 | M6x1.0                                | 20  | 7                              | 20                     | 100/400 |
| YT-2964 | M7x1.0                                | 25  | 9                              | 35                     | 100/200 |
| YT-2965 | M8x1.25                               | 25  | 9                              | 35                     | 100/400 |
| YT-2967 | M10x1.5                               | 30  | 11                             | 50                     | 70/280  |
| YT-2969 | M12x1.75                              | 38  | 14                             | 90                     | 60/240  |
| YT-2970 | M14x2.0                               | 38  | 14                             | 95                     | 63/252  |

| YATO    | size x pitch<br>rozmiar x skok gwintu | outside diameter (mm)<br>średnica zewnętrzna (mm) | thickness (mm)<br>grubość (mm) | weight (g)<br>waga (g) |        |
|---------|---------------------------------------|---|--------------------------------|------------------------|--------|
| YT-2971 | M16x2.0                               | 45  | 18                             | 160                    | 50/200 |
| YT-2972 | M18x2.5                               | 45  | 18                             | 160                    | 50/200 |
| YT-2973 | M20x2.5                               | 45  | 18                             | 150                    | 50/200 |
| YT-2960 | M22x2.5                               | 55  | 22                             | 300                    | 20/80  |
| YT-2966 | M24x3.0                               | 55  | 22                             | 300                    | 20/80  |
| YT-2968 | M27x3.0                               | 65  | 25                             | 400                    | 15/60  |
| YT-2974 | M30x3.5                               | 65  | 25                             | 400                    | 15/60  |

10

GB T-handle tap wrench  
D Werkzeughalter für Gewinde  
PL Pokrętko typu „T”  
do gwintowników  
RUS Рукоятка типа „Т”  
к гаечному ключу  
CZ Vratidlo na závitníky typ „T”  
H Menetfűr befog T-nyel  
RO Port tarod cu maner  
E Llave giramachos „T”



SLIDING  
CARD



| YATO    | size / rozmiar | L (mm) |       |
|---------|----------------|--------|-------|
| YT-2986 | M3-M8          | 70     | 20/80 |
| YT-2987 | M5-M10         | 80     | 20/80 |
| YT-2988 | M6-M12         | 90     | 20/80 |

GB Ratchet tap wrench  
D Werkzeughalter  
PL Grzechotka do gwintownika  
RUS Трещетка для метчика  
CZ Řečtačka na závitník  
H Racsnis hajtszr menetfűrhoz  
RO Port tarod  
E Carraca para macho  
de roscar



SLIDING  
CARD



| YATO    | size / rozmiar | L (mm) |       |
|---------|----------------|--------|-------|
| YT-2989 | M3-M10         | 85     | 20/80 |
| YT-2997 | M3-M10         | 250    | 20/80 |
| YT-2990 | M5-M12         | 100    | 20/80 |
| YT-2991 | M5-M12         | 300    | 20/40 |

GB Die handle  
D Schneideisenhalter  
PL Oprawa do narzynek

RUS Плашкодержатель  
CZ Závitov objímka  
H Menetvg tart

RO Portfilier  
E Portacoinete

DIN  
225



SLIDING  
CARD



| YATO    | size / rozmiar | ∅ (mm) | L (mm) |        |
|---------|----------------|--------|--------|--------|
| YT-2980 | M3-M4          | 20x5   | 200    | 25/100 |
| YT-2981 | M4.5-M6        | 20x7   | 200    | 25/100 |
| YT-2982 | M7-M9          | 25x9   | 224    | 25/100 |
| YT-2983 | M10-M11        | 30x11  | 280    | 25/50  |
| YT-2984 | M12-M14        | 38x14  | 315    | 15/30  |
| YT-2985 | M16-M20        | 45x18  | 450    | 10/20  |

GB Tap wrench  
D Werkzeughalter für Gewinde  
PL Pokrętko do gwintowników

RUS Вороток для метчиков  
CZ Ovldac kolečka na závitník  
H Hajtszr menetfűrhoz

RO Cheie (mner) pt. tarod  
E Llave giramachos

DIN  
1814



SLIDING  
CARD



| YATO    | size / rozmiar | L (mm) |        |
|---------|----------------|--------|--------|
| YT-2995 | M1-M8          | 125    | 50/200 |
| YT-2996 | M3-M10         | 180    | 25/100 |
| YT-2992 | M3-M12         | 200    | 25/100 |
| YT-2993 | M4-M12         | 280    | 25/100 |
| YT-2994 | M5-M20         | 375    | 20/40  |

- GB Thread repair set  
 D Reparatursatz für Gewinde  
 PL Zestaw do naprawy gwintów  
 RUS Набор для ремонта резьбы
- CZ Souprava na opravu závitů  
 H Menejtávító készlet  
 RO Set pt. reparare filete  
 E Juego para reparar roscas



HSS 4341  
 STAINLESS STEEL STAL NERDZEWA

METAL BOX & COLOR BOX



88 PCS

| YATO    | size / rozmiar      |      |
|---------|---------------------|------|
| YT-1769 | M6 x 1.0 x 10.8 mm  | 5/10 |
|         | M8 x 1.25 x 10.8 mm |      |
|         | M10 x 1.5 x 13.5 mm |      |

10



131 PCS

| YATO    | size / rozmiar       |      |
|---------|----------------------|------|
| YT-1763 | M5 x 0.8 x 6.7 mm    | 5/10 |
|         | M6 x 1.0 x 10.8 mm   |      |
|         | M8 x 1.25 x 10.8 mm  |      |
|         | M10 x 1.5 x 13.5 mm  |      |
|         | M12 x 1.75 x 16.3 mm |      |

- GB Wire threads  
 D Spiraleinlagen für Gewindereparatur  
 PL Wkłady spiralne do naprawy gwintów  
 RUS Метчики и сверла для ремонта резьбы
- CZ Spirálové vložky na opravu závitů  
 H Menejtávító betétek  
 RO Inserții spirală pt. reparare filete  
 E Elementos espirales para reparar roscas

for / dla: YT-1763, YT-1769

STAINLESS STEEL STAL NERDZEWA



POLYBAG WITH HEADER

| YATO    | size / rozmiar       | PCS packing |        |
|---------|----------------------|-------------|--------|
| YT-1764 | M5 x 0.8 x 6.7 mm    | 20          | 50/250 |
| YT-1765 | M6 x 1.0 x 10.8 mm   | 20          | 50/250 |
| YT-1766 | M8 x 1.25 x 10.8 mm  | 20          | 50/200 |
| YT-1767 | M10 x 1.5 x 13.5 mm  | 15          | 25/100 |
| YT-1768 | M12 x 1.75 x 16.3 mm | 10          | 25/100 |

- GB Router bit set
- D Oberfräusersatz
- PL Zestaw frezów do drewna
- RUS Набор фрез по дереву
- CZ Souprava frézů do dřeva
- H Medtjio frezj kompletas
- RO Set de freze pt. lemn
- E Juego de frezas para madera



ALUMINIUM CASE & COLOR SLEEVE



±0.08 mm

YG6X  
HSS-Co  
HSS-ER  
HSS-ER

Ø8mm

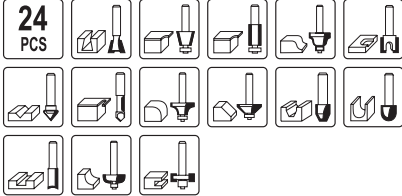

24  
PCS

YATO  
YT-6801 10

| Router bit parameter     |      |      |      |      |      |      |      |      |      |      |      |      |
|--------------------------|------|------|------|------|------|------|------|------|------|------|------|------|
| Shank diameter [mm]      | 8    | 8    | 8    | 8    | 8    | 8    | 8    | 8    | 8    | 8    | 8    | 8    |
| Length [mm]              | 42.0 | 47.0 | 47.0 | 43.5 | 50.0 | 51.5 | 51.0 | 52.0 | 58.0 | 51.5 | 58.0 | 56.5 |
| Router bit diameter [mm] | 12.7 | 12.7 | 9.5  | 12.7 | 12.7 | 9.5  | 12.7 | 16.0 | 6.35 | 6.35 | 9.5  | 12.7 |
| Cutting edge length [mm] | 12.7 | 14.8 | 11.6 | 13.0 | 12.5 | 20.0 | 20.0 | 9.5  | 19.5 | 20.0 | 24.5 | 25.0 |
| Curvature radius [mm]    | -    | -    | -    | -    | -    | 4.75 | 6.35 | -    | -    | -    | -    | -    |
| Bearing diameter [mm]    | -    | -    | -    | -    | -    | -    | -    | 12.7 | -    | -    | -    | -    |
| Angle [°]                | -    | 15   | 10   | -    | 45   | -    | -    | 15   | -    | -    | -    | -    |

| Router bit parameter     |      |      |      |      |      |      |      |      |      |      |      |      |
|--------------------------|------|------|------|------|------|------|------|------|------|------|------|------|
| Shank diameter [mm]      | 8    | 8    | 8    | 8    | 8    | 8    | 8    | 8    | 8    | 8    | 8    | 8    |
| Length [mm]              | 52.0 | 65.0 | 51.0 | 51.5 | 53.5 | 57.5 | 50.5 | 53.5 | 52.0 | 55.0 | 50.0 | 54.0 |
| Router bit diameter [mm] | 19.0 | 12.7 | 19.0 | 22.0 | 26.0 | 32.0 | 22.0 | 28.5 | 27.0 | 30.0 | 32.0 | 32.0 |
| Cutting edge length [mm] | 20.4 | 25.0 | 9.5  | 10.0 | 11.5 | 16.5 | 9.72 | 13.5 | 12.3 | 14.0 | 6.35 | 12.7 |
| Curvature radius [mm]    | -    | -    | 3.2  | 4.76 | 6.35 | 9.5  | 6.35 | 9.5  | 4.0  | -    | -    | -    |
| Bearing diameter [mm]    | -    | 12.7 | -    | 12.7 | 12.7 | 12.7 | 9.5  | 9.5  | 9.5  | 12.7 | 12.7 | 12.7 |
| Angle [°]                | -    | -    | -    | -    | -    | -    | -    | -    | -    | 45   | -    | -    |

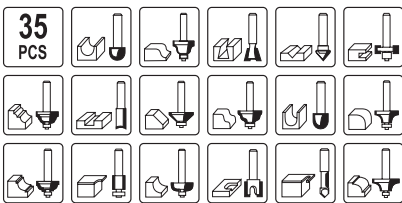

35  
PCS

YATO  
YT-6803 10

| Router bit parameter     |       |      |      |      |      |      |      |       |      |      |      |      |      |      |      |      |      |      |
|--------------------------|-------|------|------|------|------|------|------|-------|------|------|------|------|------|------|------|------|------|------|
| Shank diameter [mm]      | 8     | 8    | 8    | 8    | 8    | 8    | 8    | 8     | 8    | 8    | 8    | 8    | 8    | 8    | 8    | 8    | 8    | 8    |
| Length [mm]              | 43.0  | 38.0 | 38.0 | 50.5 | 42.0 | 43.5 | 51.5 | 49.5  | 51.5 | 58.0 | 58.5 | 56.5 | 52.0 | 58.0 | 53.5 | 66.0 | 53.0 | 65.0 |
| Router bit diameter [mm] | 6.35  | 12.7 | 12.7 | 12.7 | 12.7 | 12.7 | 14.3 | 3.175 | 6.35 | 9.5  | 12.7 | 12.7 | 19.0 | 6.35 | 9.5  | 9.5  | 12.7 | 12.7 |
| Cutting edge length [mm] | 6.0   | 9.5  | 9.5  | 18.0 | 12.7 | 13.0 | 12.3 | 13.0  | 20.0 | 24.5 | 20.3 | 25.0 | 20.4 | 19.5 | 15.0 | 26.0 | 15.0 | 25.0 |
| Curvature radius [mm]    | 3.175 | 6.35 | -    | 6.35 | -    | -    | -    | -     | -    | -    | -    | -    | -    | -    | -    | -    | -    | -    |
| Bearing diameter [mm]    | -     | -    | -    | -    | -    | -    | -    | -     | -    | -    | -    | -    | -    | -    | 9.5  | 9.5  | 12.7 | 12.7 |
| Angle [°]                | -     | -    | 45   | -    | -    | 10   | 14   | -     | -    | -    | -    | -    | -    | -    | -    | -    | -    | -    |

  

| Router bit parameter     |      |      |      |      |      |      |      |      |      |      |      |      |       |      |      |      |      |   |
|--------------------------|------|------|------|------|------|------|------|------|------|------|------|------|-------|------|------|------|------|---|
| Shank diameter [mm]      | 8    | 8    | 8    | 8    | 8    | 8    | 8    | 8    | 8    | 8    | 8    | 8    | 8     | 8    | 8    | 8    | -    |   |
| Length [mm]              | 65.5 | 55.0 | 51.0 | 55.0 | 50.0 | 52.5 | 54.0 | 55.5 | 60.0 | 60.0 | 56.0 | 60.0 | 52.5  | 58.0 | 53.5 | 57.5 | 61.0 | - |
| Router bit diameter [mm] | 19.0 | 30.0 | 26.0 | 32.0 | 32.0 | 32.0 | 32.0 | 32.0 | 32.0 | 38.0 | 32.0 | 38.0 | 26.0  | 38.0 | 26.0 | 32.0 | 38.0 | - |
| Cutting edge length [mm] | 26.0 | 14.0 | 9.7  | 13.3 | 6.35 | 8.0  | 9.5  | 15.0 | 18.5 | 20.0 | 16.0 | 19.0 | 12.5  | 17.8 | 11.5 | 16.5 | 20.8 | - |
| Curvature radius [mm]    | -    | -    | 6.35 | 9.5  | -    | -    | -    | 8.0  | 4.76 | 12.7 | 4.76 | 6.35 | 3.175 | 6.35 | 6.35 | 9.5  | 12.7 | - |
| Bearing diameter [mm]    | 19.0 | 12.7 | 12.7 | 12.7 | 12.7 | 12.7 | 12.7 | 9.5  | 12.7 | 9.5  | 9.5  | 9.5  | 9.5   | 9.5  | 12.7 | 12.7 | 12.7 | - |
| Angle [°]                | -    | 45   | -    | -    | -    | -    | -    | -    | -    | -    | -    | -    | -     | -    | -    | -    | -    | - |

GB Diamond blade  
 D Diamant-Trennscheibe  
 PL Tarcza diamentowa  
 RUS Отрезной алмазный диск  
 CZ Diamantový kotouč

H Gyémántkorong  
 RO Disc cu diamant  
 E Disco de diamante

DOUBLE BLISTER

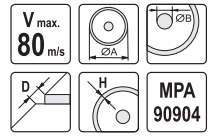

- application: concrete, brick, tile, masonry, stone
- przeznaczenie: beton utwardzony, cegła, granit, mur, kamień

- application: ceramic, glaze, glass, porcelain
- przeznaczenie: płytki ceramiczne, glazura, płytki kamienne, szkło, porcelana

- application: concrete, brick, tile, masonry, stone, sandstone
- przeznaczenie: beton utwardzony, cegła, granit, mur, kamień, piaskowiec

| YATO      | ∅A (mm) | ∅B (mm) | R.P.M.max. | D (mm) | H (mm) | Box    |
|-----------|---------|---------|------------|--------|--------|--------|
| YT-60009* | 100     | 16.0    | 14000      | 2.1    | 8.0    | 20/200 |
| YT-6002   | 115     | 22.2    | 12000      | 2.1    | 8.0    | 20/200 |
| YT-6003   | 125     | 22.2    | 11000      | 2.2    | 8.0    | 20/160 |
| YT-6004   | 180     | 22.2    | 8000       | 2.5    | 8.0    | 15/60  |
| YT-6005   | 230     | 22.2    | 6500       | 2.7    | 8.0    | 10/40  |

| YATO    | ∅A (mm) | ∅B (mm) | R.P.M.max. | D (mm) | H (mm) | Box    |
|---------|---------|---------|------------|--------|--------|--------|
| YT-6011 | 110     | 22.2    | 12000      | 2.0    | 5.3    | 20/200 |
| YT-6012 | 115     | 22.2    | 12000      | 2.1    | 5.3    | 20/200 |
| YT-6013 | 125     | 22.2    | 11000      | 2.2    | 5.3    | 20/160 |
| YT-6014 | 180     | 22.2    | 8000       | 2.5    | 5.3    | 15/60  |
| YT-6015 | 230     | 22.2    | 6500       | 2.7    | 5.3    | 10/40  |
| YT-6016 | 180     | 25.4    | 8000       | 2.2    | 5.3    | 15/60  |
| YT-6017 | 200     | 25.4    | 8000       | 2.2    | 5.3    | 10/40  |

| YATO    | ∅A (mm) | ∅B (mm) | R.P.M.max. | D (mm) | H (mm) | Box    |
|---------|---------|---------|------------|--------|--------|--------|
| YT-6022 | 115     | 22.2    | 12000      | 2.4    | 8.0    | 20/200 |
| YT-6023 | 125     | 22.2    | 11000      | 2.6    | 8.0    | 20/160 |
| YT-6024 | 180     | 22.2    | 8000       | 2.8    | 8.0    | 15/60  |
| YT-6025 | 230     | 22.2    | 6500       | 3.1    | 8.0    | 10/40  |

\* - product not for european market  
 \* - produkt nieprzeznaczony na rynek europejski

10

GB Diamond blade  
 D Diamant-Trennscheibe  
 PL Tarcza diamentowa  
 RUS Отрезной алмазный диск  
 CZ Diamantový kotouč

H Gyémántkorong  
 RO Disc cu diamant  
 E Disco de diamante



DOUBLE BLISTER



PAPER ENVELOPE



- application: concrete, reinforced concrete, clinkier, brick
- przeznaczenie: beton, beton zbrojony, klinkier, cegła

- application: concrete, reinforced concrete, clinkier, brick
- przeznaczenie: beton, beton zbrojony, klinkier, cegła

| YATO    | ∅A (mm) | ∅B (mm) | R.P.M.max. | D (mm) | H (mm) | Box |
|---------|---------|---------|------------|--------|--------|-----|
| YT-5953 | 300     | 25.4    | 5100       | 3.0    | 10.0   | 10  |
| YT-5954 | 350     | 25.4    | 4300       | 3.2    | 10.0   | 5   |
| YT-5955 | 400     | 25.4    | 3800       | 3.6    | 10.0   | 5   |

| YATO    | ∅A (mm) | ∅B (mm) | R.P.M.max. | D (mm) | H (mm) | Box |
|---------|---------|---------|------------|--------|--------|-----|
| YT-5956 | 450     | 25.4    | 3400       | 3.8    | 10.0   | 5   |



DOUBLE BLISTER



PAPER ENVELOPE



- application: natural stone, artificial stone
- przeznaczenie: kamień naturalny, kamień sztuczny

- application: natural stone, artificial stone
- przeznaczenie: kamień naturalny, kamień sztuczny

| YATO    | ∅A (mm) | ∅B (mm) | R.P.M.max. | D (mm) | H (mm) | Box |
|---------|---------|---------|------------|--------|--------|-----|
| YT-5963 | 300     | 25.4    | 5100       | 3.0    | 10.0   | 10  |
| YT-5964 | 350     | 25.4    | 4300       | 3.2    | 10.0   | 5   |
| YT-5965 | 400     | 25.4    | 3800       | 3.6    | 10.0   | 5   |

| YATO    | ∅A (mm) | ∅B (mm) | R.P.M.max. | D (mm) | H (mm) | Box |
|---------|---------|---------|------------|--------|--------|-----|
| YT-5966 | 450     | 25.4    | 3400       | 3.8    | 10.0   | 5   |



GB Diamond blade  
D Diamant-Trennscheibe  
PL Tarcza diamentowa  
RUS Отрезной алмазный диск  
CZ Diamantový kotouč

H Gyémántkorong  
RO Disc cu diamant  
E Disco de diamante



DOUBLE BLISTER



DOUBLE BLISTER



• application: ceramic tiles,  
thin natural stone tiles, glaze, glass, porcelain

• przeznaczenie: płytki ceramiczne, cienkie płytki z naturalnego kamienia, glazura, szkło, porcelana

• application: ceramic materials

• przeznaczenie: materiały ceramiczne

| YATO    | ∅A (mm) | ∅B (mm) | R.P.M.max. | D (mm) | H (mm) | ☐  |
|---------|---------|---------|------------|--------|--------|----|
| YT-5973 | 250     | 25.4    | 6100       | 1.8    | 10.0   | 20 |
| YT-5974 | 300     | 25.4    | 5100       | 2.1    | 10.0   | 10 |
| YT-5975 | 350     | 25.4    | 4300       | 2.4    | 10.0   | 5  |

| YATO    | ∅A (mm) | ∅B (mm) | R.P.M.max. | D (mm) | H (mm) | ☐  |
|---------|---------|---------|------------|--------|--------|----|
| YT-5982 | 250     | 25.4    | 6100       | 2.6    | 10.0   | 20 |
| YT-5983 | 300     | 25.4    | 5100       | 3.2    | 10.0   | 10 |
| YT-5984 | 350     | 25.4    | 4300       | 3.2    | 10.0   | 5  |



• application: asphalt, checker brick, silicate, chamotte, fresh concrete materials, other ceramic building materials

• przeznaczenie: asfalt, cegła „kratówka”, silikaty, szamot, świeży beton, inne ściernalne materiały budowlane

DOUBLE BLISTER



• application: asphalt, checker brick, silicate, chamotte, fresh concrete materials, other ceramic building materials

• przeznaczenie: asfalt, cegła „kratówka”, silikaty, szamot, świeży beton, inne ściernalne materiały budowlane

PAPER ENVELOPE



| YATO    | ∅A (mm) | ∅B (mm) | R.P.M.max. | D (mm) | H (mm) | ☐  |
|---------|---------|---------|------------|--------|--------|----|
| YT-5991 | 300     | 25.4    | 5100       | 3.2    | 10.0   | 10 |
| YT-5992 | 350     | 25.4    | 4300       | 3.2    | 10.0   | 5  |

| YATO    | ∅A (mm) | ∅B (mm) | R.P.M.max. | D (mm) | H (mm) | ☐ |
|---------|---------|---------|------------|--------|--------|---|
| YT-5994 | 450     | 25.4    | 3400       | 3.6    | 10.0   | 5 |

GB Diamond grinding cup wheel  
D Diamant-Schleifopf Schleifteller  
PL Tarcza szlifierska diamentowa  
RUS Алмазный диск шлифовальный  
CZ Diamantový brusný kotouč  
H Gyémánt csiszoló kúpos  
RO Disc cupa diamantat pt. slefuit  
E Disco diamante de lijar

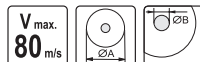

HANGING COLOR BOX



• application: concrete, clinker, natural stone  
• przeznaczenie: beton, klinkier, kamień naturalny

| YATO    | ∅A (mm) | ∅B (mm) | R.P.M.max. | segment size (mm) | ☐  |
|---------|---------|---------|------------|-------------------|----|
| YT-6030 | 125     | 22.2    | 12200      | 5.0x7.5           | 20 |
| YT-6031 | 180     | 22.2    | 8500       | 5.0x7.5           | 10 |
| YT-6032 | 125     | 22.2    | 12200      | 4.5x20.0          | 20 |
| YT-6033 | 180     | 22.2    | 8500       | 5.0x20.0          | 10 |

GB Diamond core bit drilling holes for sockets  
D Diamant-Bohrkrone  
PL Diamantowe wiertło koronowe  
RUS Алмазное сверло корончатое  
CZ Diamantový korunkový vrták  
H Gyémánt fúrókorona  
RO Carota diamantata pt. beton  
E Corona con broca diamante



COLOR BOX



| YATO    | ∅ (mm) | R.P.M.max. | segment size (mm) | ☐  |
|---------|--------|------------|-------------------|----|
| YT-6045 | 68     | 1030       | 3.5x10x24         | 24 |
| YT-6046 | 82     | 850        | 3.5x10x24         | 20 |

**GB** TCT circular saw blade for wood  
**D** Kreissägeblatt HM-Bestückt  
**PL** Piła tarczowa do drewna z węglikiem wolframu

**RUS** Диск пильный с карбидом вольфрама  
**CZ** Kotoučová píla na dřevo z karbidem wolframu  
**H** Wolframkarbidos körfűrész fához

**RO** Ferăstrău circular cu dinți din wolfram pt. lemn  
**E** Disco de sierra con carbono de tungsteno

DOUBLE BLISTER



- application: for cutting wood and plastics
- przeznaczenie: do cięcia drewna, płyt drewnopochodnych, tworzyw sztucznych

| YATO    | Ø (mm) | d (mm) | R.P.M.max. | D (mm) | thickness of blade / grubość ostrza | T  | Box   |
|---------|--------|--------|------------|--------|-------------------------------------|----|-------|
| YT-6050 | 130    | 16.0   | 10000      | 2.8    | 2.0                                 | 24 | 25/50 |
| YT-6052 | 140    | 20.0   | 10000      | 2.8    | 2.0                                 | 16 | 25/50 |
| YT-6053 | 140    | 16.0   | 10000      | 2.8    | 2.0                                 | 30 | 25/50 |
| YT-6055 | 160    | 20.0   | 9500       | 2.8    | 2.0                                 | 18 | 25/50 |
| YT-6056 | 160    | 30.0   | 9500       | 2.8    | 2.0                                 | 24 | 25/50 |
| YT-6057 | 160    | 30.0   | 9500       | 2.8    | 2.0                                 | 36 | 25/50 |
| YT-6058 | 160    | 20.0   | 9500       | 2.8    | 2.0                                 | 48 | 25/50 |
| YT-6060 | 184    | 30.0   | 9000       | 3.2    | 2.2                                 | 24 | 25/50 |
| YT-6061 | 184    | 30.0   | 9000       | 3.2    | 2.2                                 | 40 | 25/50 |
| YT-6062 | 184    | 30.0   | 9000       | 3.2    | 2.2                                 | 50 | 25/50 |
| YT-6063 | 185    | 20.0   | 9000       | 2.4    | 1.4                                 | 18 | 25/50 |
| YT-6065 | 200    | 30.0   | 8000       | 3.2    | 2.2                                 | 24 | 10/20 |
| YT-6066 | 205    | 18.0   | 6000       | 3.2    | 2.0                                 | 24 | 10/20 |
| YT-6067 | 210    | 30.0   | 8000       | 3.2    | 2.2                                 | 40 | 10/20 |
| YT-6068 | 210    | 30.0   | 8000       | 3.2    | 2.2                                 | 60 | 10/20 |

| YATO     | Ø (mm) | d (mm) | R.P.M.max. | D (mm) | thickness of blade / grubość ostrza | T  | Box   |
|----------|--------|--------|------------|--------|-------------------------------------|----|-------|
| YT-6069* | 245    | 15.9   | 6000       | 2.8    | 2.0                                 | 40 | 10/20 |
| YT-6070  | 250    | 30.0   | 6000       | 3.2    | 2.2                                 | 24 | 10/20 |
| YT-6071  | 250    | 30.0   | 6000       | 3.2    | 2.2                                 | 40 | 10/20 |
| YT-6072  | 250    | 30.0   | 6000       | 3.2    | 2.2                                 | 60 | 10/20 |
| YT-6075  | 300    | 30.0   | 6000       | 3.2    | 2.2                                 | 24 | 10    |
| YT-6076  | 300    | 30.0   | 5000       | 3.2    | 2.2                                 | 40 | 10    |
| YT-6077  | 300    | 30.0   | 5000       | 3.2    | 2.2                                 | 60 | 10    |
| YT-6078  | 300    | 30.0   | 5000       | 3.2    | 2.2                                 | 96 | 10    |
| YT-6080  | 350    | 30.0   | 4500       | 3.5    | 2.5                                 | 28 | 10    |
| YT-6081  | 350    | 30.0   | 4500       | 3.5    | 2.5                                 | 40 | 10    |
| YT-6082  | 350    | 30.0   | 4500       | 3.5    | 2.5                                 | 54 | 10    |
| YT-6083  | 350    | 30.0   | 4500       | 3.5    | 2.5                                 | 84 | 10    |
| YT-6085  | 400    | 30.0   | 4000       | 3.8    | 2.8                                 | 32 | 10    |
| YT-6086  | 400    | 30.0   | 4000       | 3.8    | 2.8                                 | 60 | 10    |

\* - product not for european market  
 \* - produkt nieprzeznaczony na rynek europejski

**GB** TCT circular saw blade for aluminium  
**D** Hartmetallbestückt Kreissägeblatt für Aluminium  
**PL** Piła tarczowa do aluminium z węglikiem wolframu

**RUS** Диск пильный по алюминию  
**CZ** Kotoučová píla na hliník s karbidem wolframu  
**H** Wolframkarbidos körfűrészslap, alumíniumhoz

**RO** Disc circular pt. aluminiu  
**E** Disco de sierra con carbono

DOUBLE BLISTER

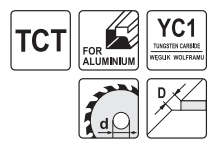

- application: for cutting aluminium profiles, laminates, plexi, corian and other plastics
- negative angle of teeth
- przeznaczenie: do cięcia profili aluminiowych, laminatów, plexi, korianu, tworzyw sztucznych
- negatywny kąt natarcia zębów

| YATO    | Ø (mm) | d (mm) | R.P.M.max. | D (mm) | thickness of blade / grubość ostrza | T   | Box   |
|---------|--------|--------|------------|--------|-------------------------------------|-----|-------|
| YT-6091 | 200    | 30     | 8000       | 3.0    | 2.2                                 | 60  | 10/20 |
| YT-6093 | 210    | 30     | 8000       | 3.0    | 2.2                                 | 72  | 10/20 |
| YT-6095 | 250    | 30     | 6000       | 3.0    | 2.2                                 | 100 | 10/20 |

| YATO    | Ø (mm) | d (mm) | R.P.M.max. | D (mm) | thickness of blade / grubość ostrza | T   | Box |
|---------|--------|--------|------------|--------|-------------------------------------|-----|-----|
| YT-6097 | 300    | 30     | 5000       | 3.0    | 2.2                                 | 100 | 10  |
| YT-6099 | 350    | 30     | 4500       | 3.2    | 2.5                                 | 100 | 10  |

**GB** Metal cutting disc  
**D** Trennscheibe für Metall  
**PL** Tarcza do cięcia metalu

**RUS** Диск отрезной по металлу  
**CZ** Kotouč pro řezání kovu  
**H** Vágókorong fémhez

**RO** Disc debitat metale  
**E** Disco cortador para metalo

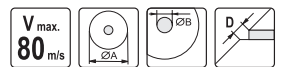

INOX

INOX

- depressed center
- wypukła

| YATO      | ØA (mm) | ØB (mm) | D (mm) | R.P.M.max. | PCS packing | Box    |
|-----------|---------|---------|--------|------------|-------------|--------|
| YT-61009* | 100     | 16      | 1.0    | 15200      | 5           | 25/200 |
| YT-6101   | 115     | 22      | 1.2    | 13200      | 5           | 25/200 |
| YT-6102   | 115     | 22      | 2.5    | 13200      | 5           | 25/200 |
| YT-6103   | 125     | 22      | 1.2    | 12200      | 5           | 25/200 |
| YT-6104   | 125     | 22      | 2.5    | 12200      | 5           | 25/200 |
| YT-6105   | 180     | 22      | 1.5    | 8600       | 5           | 25/50  |
| YT-6106   | 180     | 22      | 2.5    | 8600       | 5           | 25/100 |
| YT-6107   | 230     | 22      | 2.0    | 6500       | 5           | 25/50  |
| YT-6108   | 230     | 22      | 3.2    | 6500       | 5           | 25/50  |
| YT-61091* | 355     | 25.4    | 3.5    | 4400       | 5           | 25/50  |

| YATO    | ØA (mm) | ØB (mm) | D (mm) | R.P.M.max. | PCS packing | Box    |
|---------|---------|---------|--------|------------|-------------|--------|
| YT-5940 | 115     | 22      | 2.5    | 13200      | 5           | 25/200 |
| YT-5941 | 115     | 22      | 3.2    | 13200      | 5           | 25/200 |
| YT-5942 | 125     | 22      | 2.5    | 12200      | 5           | 25/200 |
| YT-5943 | 125     | 22      | 3.2    | 12200      | 5           | 25/200 |
| YT-5944 | 180     | 22      | 3.2    | 8600       | 5           | 25/50  |
| YT-5945 | 230     | 22      | 3.2    | 6500       | 5           | 25/50  |

| YATO    | ØA (mm) | ØB (mm) | D (mm) | R.P.M.max. | PCS packing | Box    |
|---------|---------|---------|--------|------------|-------------|--------|
| YT-5920 | 115     | 22      | 1.2    | 13200      | 5           | 25/200 |
| YT-5921 | 115     | 22      | 2.5    | 13200      | 5           | 25/200 |
| YT-5922 | 115     | 22      | 3.2    | 13200      | 5           | 25/200 |
| YT-5923 | 125     | 22      | 1.2    | 12200      | 5           | 25/200 |
| YT-5924 | 125     | 22      | 2.5    | 12200      | 5           | 25/200 |
| YT-6110 | 125     | 22      | 3.2    | 12200      | 5           | 25/200 |
| YT-5925 | 180     | 22      | 1.5    | 8600       | 5           | 25/50  |
| YT-5926 | 180     | 22      | 2.5    | 8600       | 5           | 25/50  |
| YT-6111 | 180     | 22      | 3.2    | 8600       | 5           | 25/100 |
| YT-5927 | 230     | 22      | 2.0    | 6500       | 5           | 25/50  |
| YT-6112 | 230     | 22      | 3.2    | 6500       | 5           | 25/50  |
| YT-6113 | 300     | 32      | 3.2    | 5100       | 5           | 25     |
| YT-6122 | 305     | 22      | 3.5    | 5100       | 5           | 10/20  |
| YT-6136 | 350     | 32      | 3.5    | 4400       | 5           | 25     |
| YT-6137 | 400     | 32      | 4.0    | 3800       | 5           | 25     |

\* - product not for european market  
 \* - produkt nieprzeznaczony na rynek europejski

GB Metal cutting disc  
D Trennscheibe für Metall  
PL Tarcza do cięcia metalu  
RUS Диск отрезной по металлу  
CZ Kotouč pro řezání kovu  
H Vágókorong fémhez  
RO Disc debitat metale  
E Disco cortador para metalo

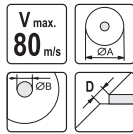

GB Metal grinding disc  
D Metall-Schleifscheibe  
PL Tarcza do szlifowania metalu  
RUS Круги для шлифования по металлу

CZ Kotouč pro broušení kovu  
H Vágókorong fémhez  
RO Disc pt. șlefuit metal  
E Disco cortador para metalo

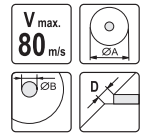

• depressed center • wypukła

| YATO    | ∅A (mm) | ∅B (mm) | D (mm) | R.P.M.max | PCS packing | Box    |
|---------|---------|---------|--------|-----------|-------------|--------|
| YT-6114 | 115     | 22      | 2.5    | 13200     | 5           | 25/200 |
| YT-6115 | 115     | 22      | 3.2    | 13200     | 5           | 25/200 |
| YT-6116 | 125     | 22      | 2.5    | 12200     | 5           | 25/200 |
| YT-6117 | 125     | 22      | 3.2    | 12200     | 5           | 25/200 |
| YT-6119 | 180     | 22      | 3.2    | 8600      | 5           | 25/100 |
| YT-6120 | 230     | 22      | 3.2    | 6500      | 5           | 25/50  |

• depressed center • wypukła

| YATO    | ∅A (mm) | ∅B (mm) | D (mm) | R.P.M.max | PCS packing | Box    |
|---------|---------|---------|--------|-----------|-------------|--------|
| YT-6121 | 115     | 22      | 6.0    | 13200     | 5           | 25/100 |
| YT-6123 | 115     | 22      | 8.0    | 13200     | 5           | 25/100 |
| YT-6124 | 125     | 22      | 6.0    | 12200     | 5           | 30/120 |
| YT-6126 | 125     | 22      | 8.0    | 12200     | 5           | 25/100 |
| YT-6138 | 180     | 22      | 6.8    | 8600      | 5           | 15/30  |
| YT-6139 | 180     | 22      | 8.0    | 8600      | 5           | 15/30  |
| YT-6125 | 230     | 22      | 6.0    | 6500      | 5           | 5/30   |
| YT-6127 | 230     | 22      | 8.0    | 6500      | 5           | 15/30  |

**INOX**

• depressed center • wypukła

| YATO    | ∅A (mm) | ∅B (mm) | D (mm) | R.P.M.max | PCS packing | Box    |
|---------|---------|---------|--------|-----------|-------------|--------|
| YT-5946 | 115     | 22      | 6.0    | 13200     | 5           | 25/100 |
| YT-5947 | 125     | 22      | 6.8    | 12200     | 5           | 25/100 |
| YT-5948 | 180     | 22      | 6.8    | 8600      | 5           | 15/30  |
| YT-5949 | 230     | 22      | 6.8    | 6500      | 5           | 15/30  |

GB Stone cutting disc  
D Trennscheibe für Stein  
PL Tarcza do cięcia kamienia  
RUS Диск отрезной по камню

CZ Kotouč pro řezání kamene  
H Vágókorong kőhöz  
RO Disc pt. tăiat piatră  
E Disco cortador de piedra

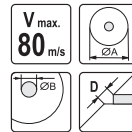

GB Stone grinding disc  
D Stein-schleifscheibe  
PL Tarcza do szlifowania kamienia  
RUS Диск для шлифования по камню  
CZ Kotouč pro broušení kamene  
H Csiszolókorong kőhöz  
RO Disc pt. șlefuit piatră  
E Disco cortador de piedra

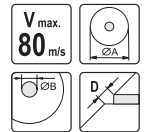

• depressed center • wypukła

| YATO    | ∅A (mm) | ∅B (mm) | D (mm) | R.P.M.max | PCS packing | Box    |
|---------|---------|---------|--------|-----------|-------------|--------|
| YT-5930 | 115     | 22      | 1.5    | 13200     | 5           | 25/200 |
| YT-5931 | 115     | 22      | 3.2    | 13200     | 5           | 25/200 |
| YT-5932 | 125     | 22      | 1.5    | 12200     | 5           | 25/200 |
| YT-5933 | 125     | 22      | 3.2    | 12200     | 5           | 25/200 |
| YT-5934 | 180     | 22      | 3.2    | 8600      | 5           | 25/50  |
| YT-5935 | 230     | 22      | 3.2    | 6500      | 5           | 25/50  |
| YT-5936 | 300     | 22      | 3.5    | 5100      | 5           | 25     |
| YT-5937 | 350     | 22      | 4.0    | 4400      | 5           | 25     |

| YATO    | ∅A (mm) | ∅B (mm) | D (mm) | R.P.M.max | PCS packing | Box    |
|---------|---------|---------|--------|-----------|-------------|--------|
| YT-6128 | 115     | 22      | 3.2    | 13200     | 5           | 25/200 |
| YT-6129 | 125     | 22      | 3.2    | 12200     | 5           | 25/200 |
| YT-6130 | 180     | 22      | 3.2    | 8600      | 5           | 25/100 |
| YT-6131 | 230     | 22      | 3.2    | 6500      | 5           | 25/50  |

• depressed center • wypukła

| YATO    | ∅A (mm) | ∅B (mm) | D (mm) | R.P.M.max | PCS packing | Box    |
|---------|---------|---------|--------|-----------|-------------|--------|
| YT-6132 | 115     | 22      | 6.0    | 13200     | 5           | 25/100 |
| YT-6133 | 125     | 22      | 6.8    | 12200     | 5           | 25/100 |
| YT-6134 | 180     | 22      | 6.8    | 8600      | 5           | 15/30  |
| YT-6135 | 230     | 22      | 6.8    | 6500      | 5           | 15/30  |

- GB Cable cutter  
 D Kabelschere  
 PL Szczypce do cięcia przewodów  
 RUS Кабелерезы  
 CZ Elektrické upichováky  
 H Kábelvágó  
 RO Patent tăietor pt. electrice  
 E Tijeras para cables

SLIDING CARD



|  |   |                  |
|--|---|------------------|
|  | <b>160 mm</b>   | <b>210 mm</b>    |
|  | <b>240 mm</b>   | <b>HRC 55-60</b> |
|  | <b>CrV 50</b><br>DROP FORGED STEEL<br>STAL KUTA NA ZBIWNO |                  |



- application: for copper and aluminium electric cables
- przeznaczenie: do cięcia miedzianych i aluminiumowych kabli

| YATO    | L (mm) | max. Ø (mm) |      |
|---------|--------|-------------|------|
| YT-1966 | 160    | 6           | 6/60 |
| YT-1967 | 210    | 7           | 6/60 |
| YT-1968 | 240    | 8           | 6/48 |

- GB Heavy duty cable cutter  
 D Schwere Drahtschere  
 PL Wzmocnione nożyce do cięcia przewodów  
 RUS Кабелерезы  
 CZ Elektrické upichováky  
 H Kábelvágó  
 RO Patent tăietor pt. electrice  
 E Tijeras para cables

SLIDING CARD



|  |   |                  |
|--|---|------------------|
|  | <b>240 mm</b>   | <b>HRC 55-60</b> |
|  | <b>CrV 50</b><br>DROP FORGED STEEL<br>STAL KUTA NA ZBIWNO |                  |



- application: for copper and aluminium electric cables
- przeznaczenie: do cięcia miedzianych i aluminiumowych kabli

| YATO    | L (mm) | max. Ø (mm) |      |
|---------|--------|-------------|------|
| YT-1969 | 240    | 9           | 6/48 |

- GB Heavy duty cable cutter  
 D Schwere Drahtschere  
 PL Wzmocnione nożyce do cięcia przewodów  
 RUS Кабелерезы  
 CZ Elektrické upichováky  
 H Kábelvágó  
 RO Patent tăietor pt. electrice  
 E Tijeras para cables

SLIDING CARD



|  |   |   |             |
|--|---|---|-------------|
|  | <b>230 mm</b>                           | <b>HRC 58-61</b>                                      | <b>CrMo</b> |
|  | <b>Lever for increase cutting power</b> | <b>Ideal for copper and aluminium electric cables</b> |             |



| YATO    | L (mm) | max. Ø (mm) |      |
|---------|--------|-------------|------|
| YT-1933 | 230    | 9           | 6/36 |

- GB Tin snips  
 D Blechscher  
 PL Nożyce do cięcia blachy  
 RUS Ножницы по металлу  
 CZ Nůžky na plech  
 H Lemezvágó olló  
 RO Foarfece pt. tablă  
 E Tijeras para chapas

SLIDING CARD



|   |                  |   |
|---|------------------|---|
| <b>S55C</b><br>DROP FORGED STEEL<br>STAL KUTA NA ZBIWNO | <b>HRC 55-60</b> | <b>HIGH FREQUENCY HARDENING</b><br>HARTOWANIE IMPULSOWE |
|---|------------------|---|



| YATO    | L (mm) | cutting length (mm) | cutting capacities (mm) |                   |                  |                     |      |
|---------|--------|---------------------|-------------------------|-------------------|------------------|---------------------|------|
|         |        |                     | copper                  | cold-rolled steel | hard steel HRC35 | stainless steel 304 |      |
| YT-1963 | 200    | 40                  | 1.5                     | 1.0               | 0.6              | 0.6                 | 6/36 |
| YT-1964 | 250    | 60                  | 1.8                     | 1.2               | 0.8              | 0.8                 | 6/24 |
| YT-1965 | 300    | 75                  | 2.0                     | 1.4               | 0.8              | 0.8                 | 6/12 |

- GB Tin snips  
 D Blechscher  
 PL Nożyce do cięcia blachy  
 RUS Ножницы по металлу  
 CZ Nůžky na plech  
 H Lemezvágó olló  
 RO Foarfece pt. tablă  
 E Tijeras para chapas

SLIDING CARD



|   |                  |   |
|---|------------------|---|
| <b>S55C</b><br>DROP FORGED STEEL<br>STAL KUTA NA ZBIWNO | <b>HRC 55-60</b> | <b>HIGH FREQUENCY HARDENING</b><br>HARTOWANIE IMPULSOWE |
|---|------------------|---|



| YATO    | L (mm) | cutting length (mm) | cutting capacities (mm) |                   |                  |                     |      |
|---------|--------|---------------------|-------------------------|-------------------|------------------|---------------------|------|
|         |        |                     | copper                  | cold-rolled steel | hard steel HRC35 | stainless steel 304 |      |
| YT-1970 | 260    | 42                  | 2.0                     | 1.4               | 1.0              | 1.0                 | 6/36 |

- GB Tin snips  
 D Blechscher  
 PL Nożyce do cięcia blachy  
 RUS Ножницы по металлу  
 CZ Nůžky na plech  
 H Lemezvágó olló  
 RO Foarfece pt. tablă  
 E Tijeras para chapas

SLIDING CARD



COLOR BOX

6 PCS



|   |                  |   |
|---|------------------|---|
| <b>S55C</b><br>DROP FORGED STEEL<br>STAL KUTA NA ZBIWNO | <b>HRC 55-60</b> | <b>HIGH FREQUENCY HARDENING</b><br>HARTOWANIE IMPULSOWE |
|---|------------------|---|



| YATO    | L (mm) | cutting length (mm) | cutting capacities (mm) |                   |                  |                     | PCS (packing) |    |
|---------|--------|---------------------|-------------------------|-------------------|------------------|---------------------|---------------|----|
|         |        |                     | copper                  | cold-rolled steel | hard steel HRC35 | stainless steel 304 |               |    |
| YT-1971 | 200    | 40                  | 1.5                     | 1.0               | 0.6              | 0.6                 | 6             | 36 |
| YT-1972 | 260    | 53                  | 1.8                     | 1.2               | 0.8              | 0.8                 | 6             | 36 |
| YT-1973 | 310    | 62                  | 2.0                     | 1.4               | 0.8              | 0.8                 | 6             | 12 |

GB Tin snips  
D Blechscherer  
PL Nożyce do cięcia blachy  
RUS Ножницы по металлу  
CZ Nůžky na plech  
H Lemezvágo olló  
RO Foarfece pt. tablă  
E Tijeras para chapas



HRC  
60-62

DIN  
6438

CrMo

INCREASE CUTTING POWER  
ZWIĘKSZONA SIŁA CIĘCIA

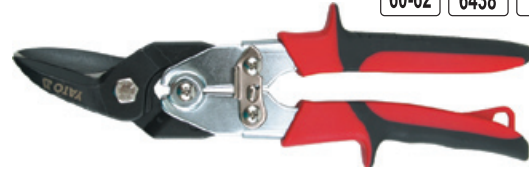

LEFT CUT  
CIĘCIE LEWE

| YATO    | L (mm) | cutting length (mm) | cutting capacities (mm) |                   |                  |                     | 6/36 |
|---------|--------|---------------------|-------------------------|-------------------|------------------|---------------------|------|
|         |        |                     | copper                  | cold-rolled steel | hard steel HRC35 | stainless steel 304 |      |
| YT-1910 | 260    | 35                  | 1.80                    | 1.50              | 1.00             | 0.90                | 6/36 |



RIGHT CUT  
CIĘCIE PRAWO



STRAIGHT CUT  
CIĘCIE PROSTE

| YATO    | L (mm) | cutting length (mm) | cutting capacities (mm) |                   |                  |                     | 6/36 |
|---------|--------|---------------------|-------------------------|-------------------|------------------|---------------------|------|
|         |        |                     | copper                  | cold-rolled steel | hard steel HRC35 | stainless steel 304 |      |
| YT-1911 | 260    | 35                  | 1.80                    | 1.50              | 1.00             | 0.90                | 6/36 |

| YATO    | L (mm) | cutting length (mm) | cutting capacities (mm) |                   |                  |                     | 6/36 |
|---------|--------|---------------------|-------------------------|-------------------|------------------|---------------------|------|
|         |        |                     | copper                  | cold-rolled steel | hard steel HRC35 | stainless steel 304 |      |
| YT-1912 | 260    | 35                  | 1.80                    | 1.50              | 1.00             | 0.90                | 6/36 |



LEFT CUT  
CIĘCIE LEWE



RIGHT CUT  
CIĘCIE PRAWO

| YATO    | L (mm) | cutting length (mm) | cutting capacities (mm) |                   |                  |                     | 6/36 |
|---------|--------|---------------------|-------------------------|-------------------|------------------|---------------------|------|
|         |        |                     | copper                  | cold-rolled steel | hard steel HRC35 | stainless steel 304 |      |
| YT-1915 | 235    | 30                  | 1.50                    | 1.20              | 1.00             | 0.70                | 6/36 |

| YATO    | L (mm) | cutting length (mm) | cutting capacities (mm) |                   |                  |                     | 6/36 |
|---------|--------|---------------------|-------------------------|-------------------|------------------|---------------------|------|
|         |        |                     | copper                  | cold-rolled steel | hard steel HRC35 | stainless steel 304 |      |
| YT-1916 | 235    | 30                  | 1.50                    | 1.20              | 1.00             | 0.70                | 6/36 |



LEFT CUT  
CIĘCIE LEWE



RIGHT CUT  
CIĘCIE PRAWO

| YATO    | L (mm) | cutting length (mm) | cutting capacities (mm) |                   |                  |                     | 6/36 |
|---------|--------|---------------------|-------------------------|-------------------|------------------|---------------------|------|
|         |        |                     | copper                  | cold-rolled steel | hard steel HRC35 | stainless steel 304 |      |
| YT-1918 | 260    | 32                  | 1.80                    | 1.50              | 1.00             | 0.90                | 6/36 |

| YATO    | L (mm) | cutting length (mm) | cutting capacities (mm) |                   |                  |                     | 6/36 |
|---------|--------|---------------------|-------------------------|-------------------|------------------|---------------------|------|
|         |        |                     | copper                  | cold-rolled steel | hard steel HRC35 | stainless steel 304 |      |
| YT-1919 | 260    | 32                  | 1.80                    | 1.50              | 1.00             | 0.90                | 6/36 |



STRAIGHT CUT  
CIĘCIE PROSTE



STRAIGHT CUT  
CIĘCIE PROSTE

| YATO    | L (mm) | cutting length (mm) | cutting capacities (mm) |                   |                  |                     | 6/36 |
|---------|--------|---------------------|-------------------------|-------------------|------------------|---------------------|------|
|         |        |                     | copper                  | cold-rolled steel | hard steel HRC35 | stainless steel 304 |      |
| YT-1922 | 290    | 75                  | 1.10                    | 0.94              | 0.70             | 0.53                | 6/36 |

| YATO    | L (mm) | cutting length (mm) | cutting capacities (mm) |                   |                  |                     | 6/36 |
|---------|--------|---------------------|-------------------------|-------------------|------------------|---------------------|------|
|         |        |                     | copper                  | cold-rolled steel | hard steel HRC35 | stainless steel 304 |      |
| YT-1923 | 230    | 25                  | 2.00                    | 1.60              | 1.20             | 1.20                | 6/36 |

GB Tin snips  
D Blechscherer  
PL Nożyce do cięcia blachy  
RUS Ножницы по металлу  
CZ Nůžky na plech

H Lemezvágo olló  
RO Foarfece pt. tablă  
E Tijeras para chapas



HRC  
56-62

CrMo

INCREASE CUTTING POWER  
ZWIĘKSZONA SIŁA CIĘCIA

SERRATED EDGES  
ZĄBOWANA KRAWĘDZ  
OSTRY  
HIGH FREQUENCY HARDENING  
HARTOWANIE MŁYSOWE



LEFT CUT  
CIĘCIE LEWE

| YATO    | L (mm) | cutting length (mm) | cutting capacities (mm) |                   |                  |                     | 6/36 |
|---------|--------|---------------------|-------------------------|-------------------|------------------|---------------------|------|
|         |        |                     | copper                  | cold-rolled steel | hard steel HRC35 | stainless steel 304 |      |
| YT-1960 | 250    | 40                  | 2.00                    | 1.50              | 1.00             | 0.80                | 6/36 |



RIGHT CUT  
CIĘCIE PRAWO

| YATO    | L (mm) | cutting length (mm) | cutting capacities (mm) |                   |                  |                     | 6/36 |
|---------|--------|---------------------|-------------------------|-------------------|------------------|---------------------|------|
|         |        |                     | copper                  | cold-rolled steel | hard steel HRC35 | stainless steel 304 |      |
| YT-1961 | 250    | 40                  | 2.00                    | 1.50              | 1.00             | 0.80                | 6/36 |



STRAIGHT CUT  
CIĘCIE PROSTE

| YATO    | L (mm) | cutting length (mm) | cutting capacities (mm) |                   |                  |                     | 6/36 |
|---------|--------|---------------------|-------------------------|-------------------|------------------|---------------------|------|
|         |        |                     | copper                  | cold-rolled steel | hard steel HRC35 | stainless steel 304 |      |
| YT-1962 | 250    | 45                  | 2.00                    | 1.50              | 1.00             | 0.80                | 6/36 |

- GB Tin snips  
 D Blechscherer  
 PL Nożyce do cięcia blachy  
 RUS Ножницы по металлу
- CZ Nůžky na plech  
 H Lemezvágó olló  
 RO Foarfece pt. tablă  
 E Tijeras para chapas



HRC 58-60



HRC 58-61

| YATO    | L (mm) | cutting length (mm) | cutting capacities (mm) |                   |                  |                     | 6/36 |
|---------|--------|---------------------|-------------------------|-------------------|------------------|---------------------|------|
|         |        |                     | copper                  | cold-rolled steel | hard steel HRC35 | stainless steel 304 |      |
| YT-1920 | 260    | 42                  | 1.20                    | 1.00              | 0.60             | 0.50                | 6/36 |

| YATO    | L (mm) | cutting length (mm) | cutting capacities (mm) |                   |                  |                     | 6/36 |
|---------|--------|---------------------|-------------------------|-------------------|------------------|---------------------|------|
|         |        |                     | copper                  | cold-rolled steel | hard steel HRC35 | stainless steel 304 |      |
| YT-1924 | 254    | 52                  | 0.94                    | 0.78              | 0.60             | 0.45                | 6/36 |

- GB Tin snips  
 D Blechscherer  
 PL Nożyce do cięcia blachy  
 RUS Ножницы по металлу  
 CZ Nůžky na plech
- H Lemezvágó olló  
 RO Foarfece pt. tablă  
 E Tijeras para chapas



LEFT CUT  
 CIECIE LEWE



RIGHT CUT  
 CIECIE PRAWE

| YATO    | L (mm) | cutting length (mm) | cutting capacities (mm) |                   |                  |                     | 6/24 |
|---------|--------|---------------------|-------------------------|-------------------|------------------|---------------------|------|
|         |        |                     | copper                  | cold-rolled steel | hard steel HRC35 | stainless steel 304 |      |
| YT-1900 | 260    | 30                  | 0.94                    | 0.78              | 0.60             | 0.45                | 6/24 |

| YATO    | L (mm) | cutting length (mm) | cutting capacities (mm) |                   |                  |                     | 6/24 |
|---------|--------|---------------------|-------------------------|-------------------|------------------|---------------------|------|
|         |        |                     | copper                  | cold-rolled steel | hard steel HRC35 | stainless steel 304 |      |
| YT-1901 | 260    | 30                  | 0.94                    | 0.78              | 0.60             | 0.45                | 6/24 |



LEFT CUT  
 CIECIE LEWE



STRAIGHT CUT  
 CIECIE PROSTE

| YATO    | L (mm) | cutting length (mm) | cutting capacities (mm) |                   |                  |                     | 6/24 |
|---------|--------|---------------------|-------------------------|-------------------|------------------|---------------------|------|
|         |        |                     | copper                  | cold-rolled steel | hard steel HRC35 | stainless steel 304 |      |
| YT-1902 | 300    | 50                  | 0.94                    | 0.78              | 0.60             | 0.45                | 6/24 |

| YATO    | L (mm) | cutting length (mm) | cutting capacities (mm) |                   |                  |                     | 6/36 |
|---------|--------|---------------------|-------------------------|-------------------|------------------|---------------------|------|
|         |        |                     | copper                  | cold-rolled steel | hard steel HRC35 | stainless steel 304 |      |
| YT-1925 | 225    | 52                  | 0.94                    | 0.78              | 0.60             | 0.45                | 6/36 |

- GB Tin snips  
 D Blechscherer  
 PL Nożyce do cięcia blachy  
 RUS Ножницы по металлу  
 CZ Nůžky na plech  
 H Lemezvágó olló  
 RO Foarfece pt. tablă  
 E Tijeras para chapas



LEFT CUT  
 CIECIE LEWE



RIGHT CUT  
 CIECIE PRAWE

| YATO    | L (mm) | cutting length (mm) | cutting capacities (mm) |                   |                  |                     | 6/36 |
|---------|--------|---------------------|-------------------------|-------------------|------------------|---------------------|------|
|         |        |                     | copper                  | cold-rolled steel | hard steel HRC35 | stainless steel 304 |      |
| YT-1913 | 225    | 30                  | 0.78                    | 0.53              | 0.46             | 0.36                | 6/36 |

| YATO    | L (mm) | cutting length (mm) | cutting capacities (mm) |                   |                  |                     | 6/36 |
|---------|--------|---------------------|-------------------------|-------------------|------------------|---------------------|------|
|         |        |                     | copper                  | cold-rolled steel | hard steel HRC35 | stainless steel 304 |      |
| YT-1914 | 225    | 30                  | 0.78                    | 0.53              | 0.46             | 0.36                | 6/36 |

- GB Portable notchers  
D Schere zum Ausschneiden von Ecken  
PL Nożyce do wycinania naroży  
RUS Ножницы для наружных углов
- CZ Nůžky na vystřihování rohů  
H Sarokkivágó olló  
RO Foarfeca pt. taierea colturilor  
E Tijera para esquinas

300 mm 90°

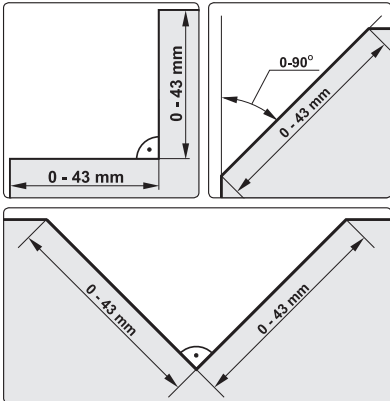

| YATO    | L (mm) |    |
|---------|--------|----|
| YT-1939 | 300    | 15 |

- GB Steel strap cutter  
D Stahlgurtblechscherer  
PL Nożyce do cięcia taśmy stalowej  
RUS Ножницы для резки стальной ленты
- CZ Nůžky na plech  
H Lemezvágó olló  
RO Foarfeca pt. tablă  
E Tijeras para bandejas de acero



HRC 58-61

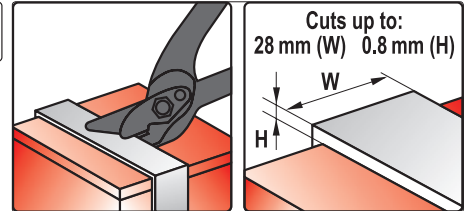

| YATO    | L (mm) | cutting length (mm) | cutting capacities (mm) |                   |                  |                     |      |
|---------|--------|---------------------|-------------------------|-------------------|------------------|---------------------|------|
|         |        |                     | copper                  | cold-rolled steel | hard steel HRC35 | stainless steel 304 |      |
| YT-1930 | 305    | 28                  | -                       | 1.00              | 0.80             | 0.60                | 6/24 |

- GB Bolt cutter  
D Drahtschere  
PL Nożyce do prętów  
RUS Болторез
- CZ Nůžky na tyče  
H Kábelvágó olló  
RO Foarfeca pt. bare  
E Cortavarillas

HRC 56-61 CrMo



| YATO    | size / rozmiar | max. Ø (mm) soft / miękki | max. Ø (mm) medium / średnio twardy |    |
|---------|----------------|---------------------------|-------------------------------------|----|
| YT-1843 | 12" (300 mm)   | 5                         | 4                                   | 20 |
| YT-1844 | 14" (350 mm)   | 7                         | 5                                   | 10 |
| YT-1845 | 18" (450 mm)   | 8                         | 6                                   | 10 |
| YT-1846 | 24" (600 mm)   | 10                        | 8                                   | 6  |
| YT-1847 | 30" (750 mm)   | 13                        | 10                                  | 4  |
| YT-1848 | 36" (900 mm)   | 16                        | 12                                  | 3  |
| YT-1849 | 42" (1050 mm)  | 19                        | 14                                  | 2  |

- GB Bolt cutter  
D Drahtschere  
PL Nożyce do prętów  
RUS Болторез
- CZ Nůžky na tyče  
H Kábelvágó olló  
RO Foarfeca pt. bare  
E Cortavarillas

CrMo



| YATO    | size / rozmiar | max. Ø (mm) |      | YATO    | size / rozmiar | max. Ø (mm) |   |
|---------|----------------|-------------|------|---------|----------------|-------------|---|
| YT-1851 | 14" (350 mm)   | 6           | 6/24 | YT-1854 | 30" (750 mm)   | 12          | 6 |
| YT-1852 | 18" (450 mm)   | 7           | 6/12 | YT-1855 | 36" (900 mm)   | 14          | 4 |
| YT-1853 | 24" (600 mm)   | 10          | 2/12 | YT-1856 | 42" (1050 mm)  | 16          | 2 |

GB Hydraulic cutter  
 D Manueller Hydraulikschneider  
 PL Ręczny obcinak hydrauliczny  
 RUS Ручной гидравлический резак  
 CZ Rucni hydraulický odřezávač  
 H Kézi hidraulikus betonacélvágó  
 RO Cutit pt. retezat tevi  
 E Cortadora hidráulica manual



STEEL  
STAL

BMC  
& COLOR  
SLEEVE



| YATO     | cutting diameter /<br>średnica cięcia (mm²) | L (mm) | pressure / nacisk (T) |   |
|----------|---|--------|-----------------------|---|
| YT-22870 | 4-12  | 430    | 6                     | 5 |
| YT-22871 | 4-16  | 430    | 8                     | 5 |
| YT-22872 | 4-20  | 515    | 13                    | 4 |

GB Heads for hydraulic cutter  
 D Austauschmesser für Hydraulikschneider  
 PL Noże wymienne do obcinaka hydraulicznego

RUS Сменные ножи для гидравлического резака  
 CZ Vyměnitelné nože do hydraulického odřezávače  
 H Cserekes a hidraulikus betonacélvágóhoz

RO Lame schimbabile pt. cutit pt. retezat tevi  
 E Cuchillas intercambiables para cortadora hidráulica

2  
PCS



| YATO     | for / dla | size / rozmiar (mm) |        |
|----------|-----------|---------------------|--------|
| YT-22873 | YT-22870  | 12                  | 10/100 |
| YT-22874 | YT-22871  | 16                  | 10/100 |
| YT-22875 | YT-22872  | 20                  | 10/100 |

GB Ratchet cable cutter  
 D Ratschenkabelschneider  
 PL Nożyce zapadkowe do kabli

RUS Кабелерез секторный  
 CZ Kleště na kabely, rohatka se západkou  
 H Racsnis kábelvágó

RO Cleste pt. taiat cablu cu clichet  
 E Cortacables de carraca

COLOR BOX



Cu/Al  
CABLE  
KABEL

60Si2Mn

HRC 50  
CUTTING BLADE  
OSTRZE TNAČE

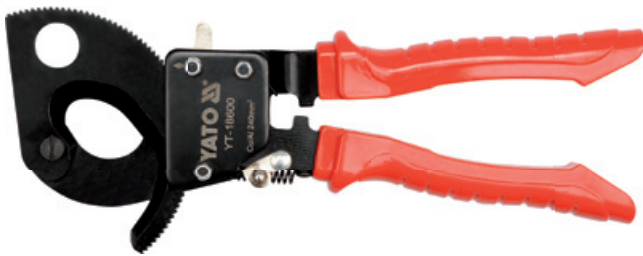

| YATO     | cutting range /<br>max. przekrój cięcia (mm²) | L (mm) |    |
|----------|---|--------|----|
| YT-18600 | 240   | 300    | 10 |

| YATO     | cutting range /<br>max. przekrój cięcia (mm²) | L (mm) |    |
|----------|---|--------|----|
| YT-18602 | 380   | 380    | 10 |

GB Cable cutter  
 D Kabelschere  
 PL Nożyce do kabli  
 RUS Кабелерезы  
 CZ Elektrické upichovky

H Kábelvágó  
 RO Patent tăietor pt. electric  
 E Tijeras para cables



COLOR BOX



STEEL  
STAL

| YATO     | cutting range /<br>max. przekrój cięcia (mm²) | L (mm) |    |
|----------|---|--------|----|
| YT-18610 | 125   | 370    | 20 |
| YT-18611 | 250   | 580    | 10 |
| YT-18612 | 500   | 770    | 5  |

GB Multi function scissors  
 D Multifunktionsmesser  
 PL Nożyce wielofunkcyjne  
 RUS Ножницы многофункциональные  
 CZ Víceúčelové nůžky  
 H Többfunkciós olló  
 RO Foarfece multifuncțional  
 E Tijeras multifuncionales



65  
mm

3Cr13  
STAINLESS  
STEEL  
STAL  
NERDZEWNA

HRC  
50-54



| YATO    | L (mm) |       |
|---------|--------|-------|
| YT-1976 | 65     | 12/72 |



GB Hand saw for wood  
D Handsäge  
PL Pila platnica do drewna  
RUS Пила по дереву  
CZ Pila na dřevo platnice  
H Fafűrész, egyenes  
RO Ferăstrău pt. lemn  
E Serrucho para madera



COLOR SLEEVE

Mn 65  
7T  
inch  
1.6 mm  
0.9 mm  
HRC 50-54

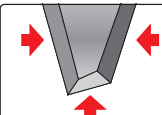

3 CUTTING EDGES  
60% FASTER CUTTING  
3 KRAWĘDZIE TNĄCE  
O 60% SZYBSZE CIĘCIE



| YATO    | L (mm) | Box   |
|---------|--------|-------|
| YT-3101 | 400    | 12/48 |
| YT-3102 | 450    | 10/40 |
| YT-3103 | 500    | 10/40 |



PTFE  
COATED

| YATO    | L (mm) | Box   |
|---------|--------|-------|
| YT-3106 | 400    | 12/48 |
| YT-3107 | 450    | 10/40 |
| YT-3108 | 500    | 10/40 |

GB Back saw  
D Rückssäge  
PL Pila grzbietnica  
RUS Пила для стусла  
CZ Pila hřebenovka  
H Kézifűrész  
RO Ferăstrău coadă de vulpe  
E Serrucho de costilla

300 mm  
Mn 65  
12T  
inch  
1.2 mm  
0.8 mm  
HRC 50-54



COLOR SLEEVE



| YATO    | L (mm) | Box   |
|---------|--------|-------|
| YT-3130 | 300    | 12/60 |

GB Compass saw  
D Stichsäge  
PL Pila otwornica  
RUS Выкружная пила  
CZ Pila otvornice

H Lyukfűrész  
RO Ferăstrău coadă de șoarece  
E Serrucho de punta

300 mm  
Mn 65  
7T  
inch  
1.6 mm  
0.9 mm  
HRC 50-54



COLOR SLEEVE

| YATO    | L (mm) | Box   |
|---------|--------|-------|
| YT-3133 | 300    | 12/60 |

GB Wallboard saw  
D Gipsäge  
PL Pila do gipsów  
RUS Ножовка по гипсокартону

CZ Pila na sádru  
H Gipsfűrész  
RO Ferăstrău pt. ghips  
E Serrucho para cartón yeso

150 mm  
Mn 65  
7T  
inch  
2.0 mm  
1.5 mm  
HRC 50-54



COLOR SLEEVE

| YATO    | L (mm) | Box   |
|---------|--------|-------|
| YT-3134 | 150    | 12/60 |

GB Bow saw  
D Bügelsäge  
PL Pila kabiłkowa  
RUS Лучковая пила

CZ Oblouková pila  
H Keretes fűrész  
RO Ferăstrău de curbură  
E Sierra de arco



2  
FUNCTION

FOR WOOD  
AND METAL  
DO DREWNA  
I METALU

| YATO    | L (mm) | Box   |
|---------|--------|-------|
| YT-3200 | 300    | 12/24 |

GB Plastic mitre box with dovetail saw  
D Kunststoffschneidladen mit Säge  
PL Plastikowa skrzynka uciosowa z pilą  
RUS Стусло пластмассовое с пилой  
CZ Přípravek na řezání úhlů s pilkou  
H Gërbevágó műanyagládá hód farkú fűrészszel  
RO Pasuitor + cutie  
E Guía de ingletar y sierra



COLOR  
BOX

350 mm  
Mn 65  
12T  
inch  
1.2 mm  
0.8 mm  
HRC 50-54

ABS

300x140  
x70mm



| YATO    | L (mm) | Box |
|---------|--------|-----|
| YT-3150 | 350    | 10  |

COLOR  
SLEEVE



HCS  
65



FOR WOOD  
DO DREWNA

\* - product not for european market  
\* - produkt nieprzeznaczony na rynek europejski

| YATO     | L (mm) | Box   |
|----------|--------|-------|
| YT-3201  | 450    | 12/24 |
| YT-3202  | 530    |       |
| YT-3203  | 610    |       |
| YT-3204  | 760    |       |
| YT-3206* | 910    |       |

GB Blade for dry wood  
 D Trockenholzsägeblatt für Handsäge  
 PL Brzeszczot do drewna suchego  
 RUS Лезвие для работы по сухому дереву  
 CZ Pílový list na suché dřevo  
 H Fűrészlap száraz fához  
 RO Lama pt. lemn uscat  
 E Hoja de sierra para madera seca

HCS  
65

DRY  
WOOD  
DREWNO  
SUCHE



COLOR SLEEVE

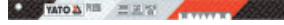

| YATO    | L (mm) |        |
|---------|--------|--------|
| YT-3220 | 300    | 50/200 |
| YT-3221 | 450    |        |
| YT-3222 | 530    |        |
| YT-3223 | 610    |        |
| YT-3224 | 760    |        |
| YT-3225 | 910    |        |

GB Blade for wet wood  
 D Nassholzsägeblatt für Handsäge  
 PL Brzeszczot do drewna mokrego  
 RUS Лезвие для работы по влажному дереву  
 CZ Pílový list na mokré dřevo  
 H Fűrészlap nedves fához  
 RO Lama pt. lemn verde  
 E Hoja de sierra para madera mojada

HCS  
65

WET  
WOOD  
DREWNO  
MOKRE



COLOR SLEEVE



\* - product not for european market  
 \* - produkt nieprzeznaczony na rynek europejski

| YATO     | L (mm) |        |
|----------|--------|--------|
| YT-3230  | 300    | 50/200 |
| YT-3231  | 450    |        |
| YT-3232  | 530    |        |
| YT-3233  | 610    |        |
| YT-3234  | 760    |        |
| YT-3235* | 910    |        |

GB Hacksaw frame  
 D Metallbogensäge  
 PL Piła do metalu  
 RUS Пила по металлу  
 CZ Pílka na železo  
 H Fémfűrész  
 RO Ferăstrău cu cadru metalic  
 E Sierra de metalo



COLOR SLEEVE



\* - product not for european market  
 \* - produkt nieprzeznaczony na rynek europejski

|           | L (mm) |     |
|-----------|--------|-----|
| YT-31631* | 150    | 300 |

10



|         | L (mm) |    |
|---------|--------|----|
| YT-3160 | 300    | 10 |



|         | L (mm) |      |
|---------|--------|------|
| YT-3161 | 300    | 6/36 |



|         | L (mm) |      |
|---------|--------|------|
| YT-3163 | 300    | 5/20 |

GB Hacksaw frame blade  
 D Metallsägeblatt  
 PL Brzeszczot do metalu

RUS Полотно по металлу  
 CZ Pílový list na kovy  
 H Fémfűrész lap

RO Panza fierastrau pt. metal  
 E Hoja de sierra para metalo

300  
mm

12  
mm



PLASTIC HANGER



|         | L (mm) | W (mm) | TPI |   |        |
|---------|--------|--------|-----|---|--------|
| YT-3460 | 300    | 12     | 24  | 5 | 10/200 |

|         | L (mm) | W (mm) | TPI |   |        |
|---------|--------|--------|-----|---|--------|
| YT-3461 | 300    | 12     | 24  | 2 | 20/500 |

|         | L (mm) | W (mm) | TPI |   |        |
|---------|--------|--------|-----|---|--------|
| YT-3462 | 300    | 12     | 24  | 2 | 20/500 |

# Cutting tools Narzędzia tnące

GB Jig saw blades  
D Stichsägeblätter  
PL Brzeszczoty do wyrzynarki

RUS Полотно для электр. станка  
CZ Pilový list do přímočaré pily  
H Dekopírlap

RO Lama fierastrau pendular  
E Recambio sierra de calar

BLISTER  
CARD



|         | L (mm) | working length (mm) | thickness (mm) | TPI |        |
|---------|--------|---------------------|----------------|-----|--------|
| YT-3400 | 100    | 75                  | 1.27           | 6   | 50/250 |



|         | L (mm) | working length (mm) | thickness (mm) | TPI |        |
|---------|--------|---------------------|----------------|-----|--------|
| YT-3401 | 100    | 75                  | 1.3            | 10  | 50/250 |



|         | L (mm) | working length (mm) | thickness (mm) | TPI |        |
|---------|--------|---------------------|----------------|-----|--------|
| YT-3402 | 100    | 75                  | 1.2            | 8   | 50/250 |



|         | L (mm) | working length (mm) | thickness (mm) | TPI |        |
|---------|--------|---------------------|----------------|-----|--------|
| YT-3403 | 100    | 75                  | 1.3            | 6   | 50/250 |



|         | L (mm) | working length (mm) | thickness (mm) | TPI |        |
|---------|--------|---------------------|----------------|-----|--------|
| YT-3404 | 100    | 75                  | 1.3            | 10  | 50/250 |



|         | L (mm) | working length (mm) | thickness (mm) | TPI |        |
|---------|--------|---------------------|----------------|-----|--------|
| YT-3405 | 100    | 75                  | 1.3            | 6   | 50/250 |



|         | L (mm) | working length (mm) | thickness (mm) | TPI |        |
|---------|--------|---------------------|----------------|-----|--------|
| YT-3407 | 75     | 50                  | 1.0            | 13  | 50/250 |



|         | L (mm) | working length (mm) | thickness (mm) | TPI  |        |
|---------|--------|---------------------|----------------|------|--------|
| YT-3408 | 115    | 90                  | 1.3            | 13-8 | 50/250 |



|         | L (mm) | working length (mm) | thickness (mm) | TPI |        |
|---------|--------|---------------------|----------------|-----|--------|
| YT-3409 | 115    | 90                  | 1.3            | 8   | 50/250 |



|         | L (mm) | working length (mm) | thickness (mm) | TPI |        |
|---------|--------|---------------------|----------------|-----|--------|
| YT-3410 | 100    | 75                  | 1.4            | 6   | 50/250 |



|         | L (mm) | working length (mm) | thickness (mm) | TPI |        |
|---------|--------|---------------------|----------------|-----|--------|
| YT-3411 | 100    | 75                  | 1.0            | 8   | 25/250 |



|         | L (mm) | working length (mm) | thickness (mm) | TPI |        |
|---------|--------|---------------------|----------------|-----|--------|
| YT-3412 | 75     | 50                  | 1.0            | 21  | 25/250 |



|         | L (mm) | working length (mm) | thickness (mm) | TPI |        |
|---------|--------|---------------------|----------------|-----|--------|
| YT-3413 | 75     | 50                  | 1.0            | 12  | 25/250 |



|         | L (mm) | working length (mm) | thickness (mm) | TPI |        |
|---------|--------|---------------------|----------------|-----|--------|
| YT-3414 | 75     | 50                  | 1.0            | 32  | 25/250 |



|         | L (mm) | working length (mm) | thickness (mm) | TPI   |        |
|---------|--------|---------------------|----------------|-------|--------|
| YT-3415 | 100    | 75                  | 1.0            | 24-10 | 25/250 |



|         | L (mm) | working length (mm) | thickness (mm) | TPI |        |
|---------|--------|---------------------|----------------|-----|--------|
| YT-3416 | 130    | 106                 | 1.0            | 21  | 25/250 |



|         | L (mm) | working length (mm) | thickness (mm) | TPI  |        |
|---------|--------|---------------------|----------------|------|--------|
| YT-3417 | 130    | 106                 | 1.27           | 10-5 | 25/250 |



|         | L (mm) | working length (mm) | thickness (mm) | TPI |        |
|---------|--------|---------------------|----------------|-----|--------|
| YT-3421 | 75     | 50                  | 1.2            | -   | 25/250 |



|         | L (mm) | working length (mm) | thickness (mm) | TPI |        |
|---------|--------|---------------------|----------------|-----|--------|
| YT-3430 | 91.5   | 74.5                | 1.3            | 10  | 25/250 |



|         | L (mm) | working length (mm) | thickness (mm) | TPI |        |
|---------|--------|---------------------|----------------|-----|--------|
| YT-3431 | 91.5   | 74.5                | 1.2            | 8   | 25/250 |



|         | L (mm) | working length (mm) | thickness (mm) | TPI |        |
|---------|--------|---------------------|----------------|-----|--------|
| YT-3432 | 91.5   | 74.5                | 1.3            | 6   | 25/250 |



|         | L (mm) | working length (mm) | thickness (mm) | TPI |        |
|---------|--------|---------------------|----------------|-----|--------|
| YT-3433 | 91.5   | 74.5                | 1.3            | 10  | 25/250 |



|         | L (mm) | working length (mm) | thickness (mm) | TPI  |        |
|---------|--------|---------------------|----------------|------|--------|
| YT-3434 | 108    | 91                  | 1.3            | 12-8 | 25/250 |



|         | L (mm) | working length (mm) | thickness (mm) | TPI |        |
|---------|--------|---------------------|----------------|-----|--------|
| YT-3435 | 100    | 83                  | 1.27           | 6   | 25/250 |

GB Jig saw blades  
D Sticksägeblätter  
PL Brzeszczoty do wyrzynarki

RUS Полотно для электр. станка  
CZ Pilový list do přímočaré pily  
H Dekopírlap

RO Lama fierastrau pendular  
E Recambio sierra de calar

BLISTER CARD



|         | L (mm) | working length (mm) | thickness (mm) | TPI       |
|---------|--------|---------------------|----------------|-----------|
| YT-3440 | 70     | 53                  | 1.0            | 21 25/250 |

|         | L (mm) | working length (mm) | thickness (mm) | TPI       |
|---------|--------|---------------------|----------------|-----------|
| YT-3441 | 70     | 53                  | 1.0            | 12 25/250 |

|         | L (mm) | working length (mm) | thickness (mm) | TPI       |
|---------|--------|---------------------|----------------|-----------|
| YT-3442 | 70     | 53                  | 1.0            | 36 25/250 |



|         | L (mm) | working length (mm) | thickness (mm) | TPI          |
|---------|--------|---------------------|----------------|--------------|
| YT-3443 | 91.5   | 74.5                | 1.0            | 21-16 25/250 |

|         | L (mm) | working length (mm) | thickness (mm) | TPI         |
|---------|--------|---------------------|----------------|-------------|
| YT-3444 | 127    | 110                 | 1.2            | 10-5 25/250 |



|         | L (mm) | working length (mm) | thickness (mm) | TPI |
|---------|--------|---------------------|----------------|-----|
| YT-3445 | 100    | 75                  | 1.3            | 10  |
|         | 100    | 75                  | 1.3            | 6   |
|         | 100    | 75                  | 1.27           | 10  |
|         | 75     | 50                  | 1.0            | 32  |
|         | 75     | 57                  | 1.0            | 12  |

10

GB Steel wire brush  
D Stahldrahtbürste  
PL Szczotka druciana

RUS Щетка стальная  
CZ Drátěný kartáč  
H Drótkefe

RO Perie de sârmă  
E Cepillo de acero



|         | rows / rzędy |
|---------|--------------|
| YT-6353 | 3 12/120     |
| YT-6354 | 4 12/120     |
| YT-6355 | 5 12/120     |
| YT-6356 | 6 12/120     |

|         | rows / rzędy |
|---------|--------------|
| YT-6357 | 3 12/72      |
| YT-6358 | 4 12/72      |
| YT-6359 | 5 12/72      |
| YT-6360 | 6 12/72      |

GB Steel wire brush  
D Stahldrahtbürste  
PL Szczotka druciana

RUS Щетка стальная  
CZ Drátěný kartáč  
H Drótkefe

RO Perie de sârmă  
E Cepillo de acero



|         | rows / rzędy | L (mm)       |
|---------|--------------|--------------|
| YT-6328 | 3            | 35x100 12/72 |

|         | rows / rzędy | L (mm)       |
|---------|--------------|--------------|
| YT-6329 | 3            | 35x100 12/72 |

## Cutting tools Narzędzia tnące

GB Steel wire brush PL Szczotka druciana CZ Drátěný kartáč RO Perie de sârmă  
D Stahlrahtbürste RUS Щетка стальная H Drótkefe E Cepillo de acero

TIED  
ON CARD



|         | rows / rzędy | L (mm) |       |
|---------|--------------|--------|-------|
| YT-6330 | 3            | 340    | 12/72 |

|         | rows / rzędy | L (mm) |       |
|---------|--------------|--------|-------|
| YT-6331 | 3            | 340    | 12/72 |



|         | rows / rzędy | L (mm) |       |
|---------|--------------|--------|-------|
| YT-6332 | 4            | 260    | 12/72 |

|         | rows / rzędy | L (mm) |       |
|---------|--------------|--------|-------|
| YT-6333 | 4            | 290    | 12/72 |



|         | rows / rzędy | L (mm) |       |
|---------|--------------|--------|-------|
| YT-6334 | 6            | 180x65 | 12/60 |

|         | rows / rzędy | L (mm) |       |
|---------|--------------|--------|-------|
| YT-6335 | 3            | 340    | 12/72 |



|         | rows / rzędy | L (mm) |       |
|---------|--------------|--------|-------|
| YT-6336 | 3            | 340    | 12/72 |

|         | rows / rzędy | L (mm) |        |
|---------|--------------|--------|--------|
| YT-6337 | 3            | 180    | 24/144 |



|         | rows / rzędy | L (mm) |       |
|---------|--------------|--------|-------|
| YT-6338 | 4            | 260    | 12/72 |

|         | rows / rzędy | L (mm) |       |
|---------|--------------|--------|-------|
| YT-6339 | 4            | 290    | 12/72 |



|         | rows / rzędy | L (mm) |        |
|---------|--------------|--------|--------|
| YT-6340 | 5            | 180    | 24/120 |

|         | rows / rzędy | L (mm) |       |
|---------|--------------|--------|-------|
| YT-6341 | 3            | 340    | 12/72 |

GB Steel wire brush PL Szczotka druciana CZ Drátěný kartáč RO Perie de sârmă  
 D Stahldrahtbürste RUS Щетка стальная H Drótkefe E Cepillo de acero

TIED  
ON CARD



|         | rows / rzędy | L (mm) |       |
|---------|--------------|--------|-------|
| YT-6342 | 3            | 340    | 12/72 |

|         | rows / rzędy | L (mm) |        |
|---------|--------------|--------|--------|
| YT-6343 | 3            | 180    | 24/144 |



|         | rows / rzędy | L (mm) |       |
|---------|--------------|--------|-------|
| YT-6344 | 4            | 260    | 12/72 |

|         | rows / rzędy | L (mm) |       |
|---------|--------------|--------|-------|
| YT-6345 | 4            | 290    | 12/72 |



|         | rows / rzędy | L (mm) |        |
|---------|--------------|--------|--------|
| YT-6346 | 5            | 180    | 24/120 |

|         | rows / rzędy | L (mm) |       |
|---------|--------------|--------|-------|
| YT-6347 | 6            | 180x65 | 12/60 |



|         | rows / rzędy | L (mm) |       |
|---------|--------------|--------|-------|
| YT-6348 | 4            | 290    | 12/72 |

|         | rows / rzędy | L (mm) |        |
|---------|--------------|--------|--------|
| YT-6349 | 5            | 180    | 24/120 |



|         | rows / rzędy | L (mm) |       |
|---------|--------------|--------|-------|
| YT-6350 | 6            | 180x65 | 12/60 |

GB Plastic handle wire brush set  
 D Bürstensatz  
 PL Komplet szczotek drucianych  
 RUS Щетки - набор  
 CZ Drátěný kartáče  
 H Kefekészlet  
 RO Perii  
 E Juego de 3 cepillos



SLIDING  
CARD

|         | rows / rzędy | L (mm) |        |
|---------|--------------|--------|--------|
| YT-6351 | 3            | 180    | 24/144 |

## Cutting tools Narzędzia tnące

GB Cup brush with shaft  
D Stahldraht-Topfbürste  
PL Szczotka czolowa z trzpieniem

RUS Щетка "чашка" со стержнем  
CZ Čelní kartáč drátěný se stopkou  
H Homlok drótkefe, nyéllel

RO Perie frontală pt. bormasina  
E Cepillo de copa con mandril

SLIDING  
CARD



|         | (mm) |      |       |
|---------|------|------|-------|
| YT-4750 | 75   | 4500 | 12/96 |

|         | (mm) |      |       |
|---------|------|------|-------|
| YT-4751 | 75   | 4500 | 12/96 |

|         | (mm) |      |       |
|---------|------|------|-------|
| YT-4752 | 75   | 6000 | 12/72 |

GB Cup brush with shaft set  
D Drahtbürste mit Einspannschaft  
PL Szczotki druciane z trzpieniem  
RUS Щетки проволочные со стержнем  
CZ Drátěný kartáč se stopkou  
H Drótkefe, csapós  
RO Perii de sarmă cu tijă  
E Cepillos de alambre con espiga



SLIDING  
CARD



|         | (mm) |      |       |
|---------|------|------|-------|
| YT-4755 | 20   | 6000 | 12/60 |
|         | 50   | 7500 |       |
|         | 50   | 4500 |       |

GB Circular brush with shaft  
D Stahldraht-Scheibenbürste  
PL Szczotka tarczowa z trzpieniem

RUS Щетка круговая со стержнем  
CZ Okružní kartáč drátěný se stopkou  
H Tarcás drótkefe, nyéllel

RO Perie rotundă pt. bormasina  
E Cepillo redondo

SLIDING  
CARD



|         | (mm) |      |       |
|---------|------|------|-------|
| YT-4757 | 100  | 4500 | 12/96 |

|         | (mm) |      |       |
|---------|------|------|-------|
| YT-4758 | 100  | 4500 | 12/96 |

|         | (mm) |       |        |
|---------|------|-------|--------|
| YT-4759 | 75   | 20000 | 10/100 |

GB Circular brush  
D Stahldraht-Scheibenbürste  
PL Szczotka tarczowa z gwintem

RUS Щетка круговая  
CZ Okružní kartáč drátěný  
H Tarcás drótkefe

RO Perie rotundă pt. bormasina  
E Cepillo redondo

COLOR  
BOX



|         | (mm) |       |      |
|---------|------|-------|------|
| YT-4761 | 100  | 12500 | 8/64 |

|         | (mm) |       |      |
|---------|------|-------|------|
| YT-4763 | 100  | 12500 | 8/64 |

|         | (mm) |       |      |
|---------|------|-------|------|
| YT-4764 | 125  | 10000 | 8/48 |

GB Cup brush  
D Stahldraht-Topfbürste  
PL Szczotka czolowa z gwintem

RUS Щетка "чашка"  
CZ Čelní kartáč drátěný  
H Homlok drótkefe

RO Perie frontală  
E Cepillo de copa

COLOR  
BOX



|         | (mm) |      |      |
|---------|------|------|------|
| YT-4766 | 100  | 8500 | 4/32 |

|         | (mm) |       |       |
|---------|------|-------|-------|
| YT-4767 | 60   | 12500 | 10/80 |

|         | (mm) |       |      |
|---------|------|-------|------|
| YT-4768 | 75   | 11000 | 6/36 |

|         | (mm) |      |      |
|---------|------|------|------|
| YT-4769 | 100  | 8500 | 4/16 |

- GB Electrician's knife  
 D Montagemesser  
 PL Nóż składany monterski  
 RUS Нож складной
- CZ Montážní nůž  
 H Szerelőkés  
 RO Cuțit pt. decablat  
 E Cuchillo de montaje

SLIDING  
CARD



|         |      |         |      |
|---------|------|---------|------|
| YT-7600 | 6/96 | YT-7601 | 6/96 |
|---------|------|---------|------|

- GB Folding knife with bits  
 D Klappmesser  
 PL Nóż składany z bitami  
 RUS Нож складной
- CZ Kapesní nůž  
 H Zsebkés  
 RO Briceag  
 E Navaja

BLISTER  
CARD



3, 4 mm;  
PH1, PH2;

3, 4 mm;  
T10, T20

|          |      |
|----------|------|
| YT-76031 | 4/40 |
|----------|------|

- GB Folding knife  
 D Klappmesser  
 PL Nóż składany
- RUS Нож складной  
 CZ Kapesní nůž  
 H Zsebkés
- RO Briceag  
 E Navaja

SLIDING  
CARD



|          |       |
|----------|-------|
| YT-76050 | 12/72 |
|----------|-------|



|          |        |
|----------|--------|
| YT-76051 | 12/120 |
|----------|--------|



|          |        |
|----------|--------|
| YT-76052 | 12/120 |
|----------|--------|



Cutting tools  
Narzędzia tnące

- GB Multi knife
- D Klappmesser
- PL Nóż wielofunkcyjny
- RUS Нож складной
- CZ Kapesní nůž
- H Zsebkés
- RO Briceag
- E Navaja



SLIDING  
CARD

YT-76030

12/96

- GB Multi knife
- RUS Нож складной
- RO Briceag
- D Klappmesser
- CZ Kapesní nůž
- E Navaja
- PL Narzędzie wielofunkcyjne
- H Zsebkés

BLISTER  
CARD



YT-76040

10/100

YT-76041

12/48



YT-76042

12/48

YT-76043

6/36

GB Cutter knife  
D Universalmesser  
PL Nożyk z ostrzem trapezowym

RUS Ножи универсальные  
CZ Univerzální nůž  
H Univerzális kés

RO Cuțit universal  
E Cutter con filo trapezoidal



TRY ME  
DOUBLE  
BLISTER



DOUBLE  
BLISTER



|         |           |      |
|---------|-----------|------|
|         | (mm)      |      |
| YT-7520 | 61x33x0.5 | 6/48 |

|         |           |      |
|---------|-----------|------|
|         | (mm)      |      |
| YT-7522 | 61x33x0.5 | 6/48 |



SLIDING  
CARD



COLOR BOX



|         |           |      |
|---------|-----------|------|
|         | (mm)      |      |
| YT-7523 | 61x33x0.5 | 6 48 |

GB Cutter knife  
D Universalmesser  
PL Nożyk z ostrzem trapezowym

RUS Ножи универсальные  
CZ Univerzální nůž  
H Univerzális kés

RO Cuțit universal  
E Cutter con filo trapezoidal



DOUBLE  
BLISTER



DOUBLE  
BLISTER



|         |           |       |
|---------|-----------|-------|
|         | (mm)      |       |
| YT-7532 | 61x33x0.5 | 12/72 |

|         |           |       |
|---------|-----------|-------|
|         | (mm)      |       |
| YT-7534 | 61x33x0.5 | 12/72 |

GB Utility knife  
D Universalmesser  
PL Nożyk z łamanym ostrzem  
RUS Нож универсальный

CZ Nůž na tapety  
H Tapétaolító  
RO Cuțitaș pt. tapet  
E Cuchillo para papel de empapelar

SLIDING  
CARD



|         |       |        |
|---------|-------|--------|
|         | (mm)  |        |
| YT-7500 | 9x0.4 | 24/240 |

|         |        |        |
|---------|--------|--------|
|         | (mm)   |        |
| YT-7501 | 18x0.4 | 12/120 |



|         |        |       |
|---------|--------|-------|
|         | (mm)   |       |
| YT-7571 | 9x0.4  | 20/80 |
| YT-7581 | 18x0.4 | 20/80 |

|         |        |      |
|---------|--------|------|
|         | (mm)   |      |
| YT-7510 | 25x0.7 | 6/48 |

## Cutting tools Narzędzia tnące

GB Utility knife  
D Universalmesser  
PL Nożyk z łamanym ostrzem

RUS Нож универсальный  
CZ Nůž na tapety  
H Tapétaolló

RO Cuțitaș pt. tapet  
E Cuchillo para papel de empapelar

SLIDING  
CARD



|         | (mm)   |        |
|---------|--------|--------|
| YT-7511 | 9x0.4  | 24/288 |
| YT-7512 | 18x0.5 | 12/96  |

|         | (mm)   |        |
|---------|--------|--------|
| YT-7504 | 9x0.4  | 24/240 |
| YT-7505 | 18x0.5 | 24/240 |



|         | (mm)   |        |
|---------|--------|--------|
| YT-7506 | 9x0.4  | 24/240 |
| YT-7507 | 18x0.5 | 12/144 |

|         | (mm)   |        |
|---------|--------|--------|
| YT-7502 | 9x0.4  | 24/240 |
| YT-7503 | 18x0.5 | 12/144 |



|         | (mm)   |        |
|---------|--------|--------|
| YT-7508 | 9x0.4  | 12/144 |
| YT-7509 | 18x0.5 | 12/96  |

GB Spare blades  
D Abbrechklingen  
PL Ostrza zapasowe  
RUS Лезвия для универсальных  
ножей

CZ Lomené ostří náhradní  
H Törhető tartalékpenge  
RO Lame de rezervă rupte  
E Fila partido de recambio

PLASTIC  
BOX  
& SLIDING  
CARD



|         | (mm)   |      |
|---------|--------|------|
| YT-7530 | 25x0.7 | 6/48 |



|         | (mm)      |        |
|---------|-----------|--------|
| YT-7531 | 61x33x0.5 | 24/144 |



|         | (mm)   |        |
|---------|--------|--------|
| YT-7528 | 9x0.4  | 24/144 |
| YT-7529 | 18x0.5 | 24/144 |

GB Spare blades  
D Abbrechklingen  
PL Ostrza zapasowe  
RUS Лезвия для универсальных  
ножей

CZ Lomené ostří náhradní  
H Törhető tartalékpenge  
RO Lame de rezervă rupte  
E Fila partido de recambio

PLASTIC  
BOX  
& SLIDING  
CARD



|         | (mm)   |        |
|---------|--------|--------|
| YT-7524 | 9x0.4  | 24/240 |
| YT-7525 | 18x0.5 | 24/144 |



|         | (mm)      |        |
|---------|-----------|--------|
| YT-7527 | 61x33x0.5 | 24/144 |

GB Electrician scissors  
D Elektrische Schere  
PL Nożyczki dla elektryków  
RUS Ножницы универсальные  
CZ Elektrické nůžky

H Univerzális olló  
RO Foarfece - electrician  
E Tijeras eléctricos

GB Scissors  
D Haushaltsschere  
PL Nożyczki  
RUS Ножницы

CZ Nůžky  
H Olló  
RO Foarfece  
E Tijeras



SLIDING  
CARD



SLIDING  
CARD



|         | L (mm) |        |
|---------|--------|--------|
| YT-1974 | 140    | 12/120 |

|          | L (mm) |        |
|----------|--------|--------|
| YT-19763 | 170    | 12/120 |
| YT-19764 | 190    | 12/120 |
| YT-19765 | 215    | 12/120 |
| YT-19766 | 245    | 12/120 |
| YT-19767 | 300    | 12/120 |

- GB Glass oil cutter  
 D Glasschneider  
 PL Nóż olejowy do szkła  
 RUS Стеклорез масляный
- CZ Řezák na sklo  
 H Olajkés üveghez  
 RO Diamant pt. taiat stricla cu ulei
- E Cuchillo de aceite para cristalinación

SLIDING CARD



|         | L (mm) |       |
|---------|--------|-------|
| YT-7560 | 177    | 6/120 |

|         | L (mm) |       |
|---------|--------|-------|
| YT-7561 | 178    | 6/120 |

- GB Scriber for glass, ceramics and metal  
 D Reißnadel für Glas, Keramik und Metall  
 PL Rysik do szkła, ceramiki i metalu
- RUS Штихель для стекла, керамика и металла  
 CZ Rýsovací jehla na sklo, keramiku a kov  
 H Karttű üveghez, kerámiához és fémhez
- RO Ac de trasat pt. sticlă, ceramică și metal  
 E Trazador para vidrio, cerámica y metal

SLIDING CARD



|         | L (mm) |       |
|---------|--------|-------|
| YT-3740 | 140    | 6/240 |

- GB Double edge trimmer  
 D Kantentrimmer  
 PL Dwustronny nóż do odcinania oklein  
 RUS Двусторонний нож для мебельной пленки
- CZ Orezávací nuž na hrany lamina  
 H Kétélű vágó  
 RO Rindea pt. finisaje  
 E Cuchillo de doble filo para cortar chapas de madera



SLIDING CARD



|         | L (mm) |  |
|---------|--------|--|
| YT-5710 | 6/48   |  |

- GB Profile gauge  
 D Profilmuster  
 PL Wzornik profili
- RUS Шаблон профилей  
 CZ Profilová šablona  
 H Profilsablon
- RO Șablon profile  
 E Plantilla de perfiles

SLIDING CARD



|         | L (mm) |       |
|---------|--------|-------|
| YT-3735 | 125    | 24/72 |

|         | L (mm) |       |
|---------|--------|-------|
| YT-3736 | 260    | 10/40 |

- GB Punch set  
 D Lederlocher-set  
 PL Przebijaki do skóry  
 RUS Набор пробойников для кожи  
 CZ Sada průbojníků na kůži  
 H Bőrlükasztó készlet  
 RO Set preducele  
 E Juego de perforar en piel

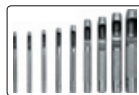

POUCH & COLOR BOX



|         | size / rozmiar                               |    |
|---------|--|----|
| YT-3590 | 2.5; 3.0; 4.0; 5.0; 6.0; 7.0; 8.0; 9.0; 10.0 | 50 |

|         | size / rozmiar  |    |
|---------|---|----|
| YT-3591 | 2.0; 2.5; 3.2; 4.0; 4.8; 5.5; 6.4; 8.0; 9.5; 11.1; 12.7; 14.0; 15.8; 19.0; 22.0 | 10 |

## Cutting tools Narzędzia tnące

GB PVC pipe cutter  
D PVC Rohrabscneider  
PL Obcinak do rur PCV  
RUS Труборез для ПВХ труб

CZ Řezač PVC trubek  
H Csővágó olló PVC csövekhez  
RO Clește pt. tăiat țevi din PVC  
E Cortatubos PVC

SLIDING  
CARD



|         | max. (mm) |      |
|---------|-----------|------|
| YT-2230 | 35        | 6/48 |

|         | max. (mm) |      |
|---------|-----------|------|
| YT-2231 | 42        | 6/48 |



|         | max. (mm) |      |
|---------|-----------|------|
| YT-2228 | 51        | 6/24 |

|         | max. (mm) |      |
|---------|-----------|------|
| YT-2229 | 64        | 6/24 |

GB Pipe cutter  
D Rohrabscneider  
PL Obcinak do rur  
RUS Труборез для труб  
CZ Řezač trubek  
H Csővágó olló  
csövekhez  
RO Clește pt. tăiat țevi  
E Cortatubos

COLOR BOX



|         | 3/8"-1-5/8" (10-40 mm) |    |
|---------|------------------------|----|
| YT-2232 |                        | 20 |

|         | 1/4"-7/4" (6-45 mm) |    |
|---------|---------------------|----|
| YT-2233 |                     | 25 |



|         | 1/2"-5/2" (14-63 mm) |    |
|---------|----------------------|----|
| YT-2234 |                      | 25 |

|         | 2"-5" (50-127 mm) |    |
|---------|-------------------|----|
| YT-2235 |                   | 10 |

GB Window scraper  
D Fensterabstreicher  
PL Skrobak do szyb

RUS Скребок для стекла  
CZ Škrabák na skla  
H Kaparó üveghez

RO Răzuitor pt. geamuri  
E Rascador de cristales

HALF  
DOUBLE  
BLISTER



| L (mm)  |     |       |
|---------|-----|-------|
| YT-7550 | 300 | 10/60 |



| L (mm)  |         |       |
|---------|---------|-------|
| YT-7551 | 390-600 | 10/60 |

10

GB Scraper  
D Ziehklinge  
PL Cyklina  
RUS Цикля

CZ Škrabka na parkety  
H Simitógyalu  
RO Honuitor  
E Raspador

HALF  
DOUBLE  
BLISTER



| L (mm)  |     |      |
|---------|-----|------|
| YT-5702 | 240 | 6/48 |



| L (mm)  |     |      |
|---------|-----|------|
| YT-5703 | 250 | 6/48 |



| L (mm)  |     |      |
|---------|-----|------|
| YT-5704 | 290 | 6/48 |

## Cutting tools Narzędzia tnące

GB Steel file  
D Werkstatt-Feile  
PL Piłnik do metalu  
RUS Напильник слесарный

CZ Zámeňický pilník  
H Lakatos reszelő  
RO Pila de lăcătușerie  
E Lima para metal

PLASTIC  
HANGER



| #       | L (mm) |     |       |
|---------|--------|-----|-------|
| YT-6223 | 1      | 250 | 20/80 |
| YT-6180 | 2      | 150 | 20/80 |
| YT-6185 | 2      | 200 | 20/80 |
| YT-6228 | 2      | 250 | 20/80 |
| YT-6190 | 2      | 300 | 10/40 |
| YT-6233 | 3      | 250 | 20/80 |

| #       | L (mm) |     |       |
|---------|--------|-----|-------|
| YT-6224 | 1      | 250 | 20/80 |
| YT-6181 | 2      | 150 | 20/80 |
| YT-6186 | 2      | 200 | 20/80 |
| YT-6229 | 2      | 250 | 20/80 |
| YT-6191 | 2      | 300 | 10/40 |



| #       | L (mm) |     |       |
|---------|--------|-----|-------|
| YT-6225 | 1      | 250 | 20/80 |
| YT-6182 | 2      | 150 | 20/80 |
| YT-6187 | 2      | 200 | 20/80 |
| YT-6230 | 2      | 250 | 20/80 |
| YT-6192 | 2      | 300 | 10/40 |
| YT-6234 | 3      | 250 | 20/80 |

| #       | L (mm) |     |       |
|---------|--------|-----|-------|
| YT-6226 | 1      | 250 | 20/80 |
| YT-6183 | 2      | 150 | 20/80 |
| YT-6188 | 2      | 200 | 20/80 |
| YT-6231 | 2      | 250 | 20/80 |
| YT-6193 | 2      | 300 | 10/40 |
| YT-6235 | 3      | 250 | 20/80 |



| #       | L (mm) |     |       |
|---------|--------|-----|-------|
| YT-6227 | 1      | 250 | 20/80 |
| YT-6184 | 2      | 150 | 20/80 |
| YT-6189 | 2      | 200 | 20/80 |
| YT-6232 | 2      | 250 | 20/80 |
| YT-6194 | 2      | 300 | 10/40 |
| YT-6236 | 3      | 250 | 20/80 |

GB Steel file set  
D Werkstatt-Feilen  
PL Piłniki do metalu  
RUS Набор напильников слесарных

CZ Zámeňické pilníky  
H Lakatos reszelő  
RO Pile de lăcătușerie  
E Juego de limas para metal

SLIDING  
CARD



|         |       |
|---------|-------|
| YT-6237 | 10/20 |
|---------|-------|

|         |      |
|---------|------|
| YT-6238 | 5/10 |
|---------|------|

|         |      |
|---------|------|
| YT-6239 | 5/10 |
|---------|------|

GB Needle file set  
 D Nadelfeilsatz  
 PL Zestaw pilników iglaków  
 RUS Набор напильников надфили

CZ Sada jehlových pilníků  
 H Túreszelő készlet  
 RO Set pile conice  
 E Juego de limas de aguja

POUCH

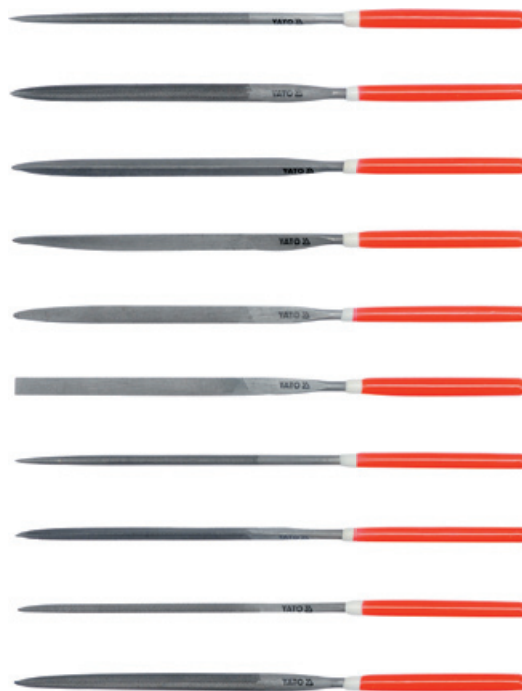

|         | working length /<br>długość robocza (mm) | mm    |        |
|---------|--|-------|--------|
| YT-6160 | 65                                       | 3x140 | 50/200 |
| YT-6161 | 75                                       | 4x160 | 25/100 |
| YT-6162 | 85                                       | 5x180 | 25/100 |

|         | working length /<br>długość robocza (mm) | mm    |        |
|---------|--|-------|--------|
| YT-6163 | 65                                       | 3x140 | 25/100 |
| YT-6164 | 75                                       | 4x160 | 25/100 |
| YT-6165 | 85                                       | 5x180 | 25/50  |

GB Diamond needle file  
 D Diamant-Nadelfeile  
 PL Pilnik iglak diamentowy  
 RUS Надфиль алмазный

CZ Diamantový jehlový pilník  
 H Gyémánt túreszelő  
 RO Pila diamentata  
 E Lima de aguja adiamantada

SLIDING  
CARD



|         | grit /<br>ziarnistość | coating length /<br>długość nasypu (mm) | mm    |          |
|---------|-----------------------|---|-------|----------|
| YT-6140 | 150                   | 50                                      | 3x140 | 120/1200 |
| YT-6147 | 150                   | 50                                      | 4x160 | 80/800   |
| YT-6152 | 150                   | 70                                      | 5x180 | 45/450   |

|         | grit /<br>ziarnistość | coating length /<br>długość nasypu (mm) | mm    |          |
|---------|-----------------------|---|-------|----------|
| YT-6141 | 150                   | 50                                      | 3x140 | 120/1200 |
| YT-6148 | 150                   | 50                                      | 4x160 | 80/800   |
| YT-6153 | 150                   | 70                                      | 5x180 | 45/450   |

|         | grit /<br>ziarnistość | coating length /<br>długość nasypu (mm) | mm    |          |
|---------|-----------------------|---|-------|----------|
| YT-6142 | 150                   | 50                                      | 3x140 | 120/1200 |
| YT-6149 | 150                   | 50                                      | 4x160 | 80/800   |
| YT-6154 | 150                   | 70                                      | 5x180 | 45/450   |

GB Diamond needle file set  
 D Diamant-Nadelfeilsatz  
 PL Zestaw pilników diamentowych iglaków  
 RUS Набор надфилей алмазных

CZ Sada diamentových jehlových pilníků  
 H Gyémánt túreszelő készlet  
 RO Set pile diamentate  
 E Juego de limas de aguja adiamantadas

POUCH



|         | grit /<br>ziarnistość | coating length /<br>długość nasypu (mm) | mm    |        |
|---------|-----------------------|---|-------|--------|
| YT-6143 | 150                   | 50                                      | 3x140 | 40/400 |
| YT-6150 | 150                   | 50                                      | 4x160 | 30/300 |
| YT-6155 | 150                   | 70                                      | 5x180 | 15/150 |

|         | grit /<br>ziarnistość | coating length /<br>długość nasypu (mm) | mm    |        |
|---------|-----------------------|---|-------|--------|
| YT-6156 | 150                   | 70                                      | 5x180 | 10/100 |



# Cutting tools Narzędzia tnące

- GB Diamond needle file set  
 D Diamant-Nadelfeilsatz  
 PL Zestaw pilników diamentowych iglaków  
 RUS Набор надфилей алмазных
- CZ Sada diamantových jehlových pilníků  
 H Gyémánt tűreszelő készlet  
 RO Set pile diamantate  
 E Juego de limas de aguja adiamantadas

POUCH

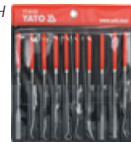

|         | grit /<br>ziarnistość | coating length /<br>długość nasypu (mm) | mm    |        |
|---------|-----------------------|---|-------|--------|
| YT-6144 | 150                   | 50                                      | 3x140 | 12/120 |

|         | grit /<br>ziarnistość | coating length /<br>długość nasypu (mm) | mm    |        |
|---------|-----------------------|---|-------|--------|
| YT-6145 | 150                   | 25                                      | 3x140 | 12/120 |



|         | grit /<br>ziarnistość | coating length /<br>długość nasypu (mm) | mm    |        |
|---------|-----------------------|---|-------|--------|
| YT-6146 | 150                   | 30                                      | 3x140 | 12/120 |

|         | grit /<br>ziarnistość | coating length /<br>długość nasypu (mm) | mm    |      |
|---------|-----------------------|---|-------|------|
| YT-6151 | 150                   | 50                                      | 4x160 | 9/90 |

GB Wood rasp  
 D Holzraspel  
 PL Tarnik do drewna  
 RUS Рашлиля для дерева

CZ Rašple do dřeva  
 H Fareszelő  
 RO Raspe  
 E Escarpelo para madera

PLASTIC  
 HANGER



| #       |    |       |
|---------|----|-------|
| YT-6219 | 45 | 12/72 |



| #       |    |       |
|---------|----|-------|
| YT-6220 | 45 | 12/72 |



| #       |    |       |
|---------|----|-------|
| YT-6221 | 45 | 12/72 |

10

GB Wood rasp set  
 D Holzraspelsatz  
 PL Tarniki do drewna  
 RUS Рашлили для дерева  
 CZ Sada rašplí do dřeva

H Fareszelő  
 RO Set raspe  
 E Juego de escarpelos para madera

SLIDING  
 CARD



| #       |    |      |
|---------|----|------|
| YT-6222 | 45 | 5/20 |

# Cutting tools Narzędzia tnące

GB Sand paper PL Papier ścierny CZ Smirkový papír RO Hârtie abrazivă  
D Schleifpapier RUS Наждачная бумага H Csiszolópapír E Papel de lija

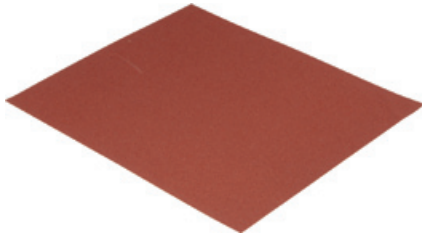

POLYBAG



- application: paint, lacquer, filler, wood
- abrasive: aluminium oxide
- bond: synthetic resin
- backing: C
- coating: semi-open
- zastosowanie: farby, lakiery, szpachle, drewno
- ścierniwo: tlenek aluminium
- spoiwo: żywica syntetyczna
- podkład: C
- nasyp półotwarty



- application: paint, lacquer, filler, wood
- abrasive: aluminium oxide
- bond: synthetic resin
- backing: D
- coating: semi-open
- zastosowanie: farby, lakiery, szpachle, drewno
- ścierniwo: tlenek aluminium
- spoiwo: żywica syntetyczna
- podkład: D
- nasyp półotwarty

|         | grit / ziarnistość | size / rozmiar (mm) |    |     |
|---------|--------------------|---------------------|----|-----|
| YT-8350 | 40                 | 230x280             | 50 | 500 |
| YT-8351 | 60                 | 230x280             | 50 | 500 |
| YT-8352 | 80                 | 230x280             | 50 | 500 |
| YT-8353 | 100                | 230x280             | 50 | 500 |
| YT-8354 | 120                | 230x280             | 50 | 500 |
| YT-8355 | 150                | 230x280             | 50 | 500 |
| YT-8356 | 180                | 230x280             | 50 | 500 |
| YT-8357 | 220                | 230x280             | 50 | 500 |
| YT-8358 | 240                | 230x280             | 50 | 500 |

|         | grit / ziarnistość | size / rozmiar |       |  |
|---------|--------------------|----------------|-------|--|
| YT-8449 | 40                 | 93 mm x 5 m    | 12/48 |  |
| YT-8450 | 60                 | 93 mm x 5 m    | 12/48 |  |
| YT-8451 | 80                 | 93 mm x 5 m    | 12/48 |  |
| YT-8452 | 100                | 93 mm x 5 m    | 12/48 |  |
| YT-8453 | 120                | 93 mm x 5 m    | 12/48 |  |
| YT-8454 | 150                | 93 mm x 5 m    | 12/48 |  |
| YT-8455 | 180                | 93 mm x 5 m    | 12/48 |  |
| YT-8456 | 240                | 93 mm x 5 m    | 12/48 |  |
| YT-8457 | 320                | 93 mm x 5 m    | 12/48 |  |



POLYBAG WITH HEADER



- application: paint, lacquer, filler, wood
- abrasive: aluminium oxide
- bond: synthetic resin
- backing: D
- coating: semi-open
- zastosowanie: farby, lakiery, szpachle, drewno
- ścierniwo: tlenek aluminium
- spoiwo: żywica syntetyczna
- podkład: D
- nasyp półotwarty

- application: paint, lacquer, filler, wood
- abrasive: aluminium oxide
- bond: synthetic resin
- backing: D
- coating: semi-open
- zastosowanie: farby, lakiery, szpachle, drewno
- ścierniwo: tlenek aluminium
- spoiwo: żywica syntetyczna
- podkład: D
- nasyp półotwarty

|         | grit / ziarnistość | size / rozmiar (mm) |   |        |
|---------|--------------------|---------------------|---|--------|
| YT-8370 | 40                 | 115x280             | 5 | 24/240 |
| YT-8371 | 60                 | 115x280             | 5 | 24/240 |
| YT-8372 | 80                 | 115x280             | 5 | 24/240 |
| YT-8373 | 100                | 115x280             | 5 | 24/240 |
| YT-8374 | 120                | 115x280             | 5 | 24/240 |
| YT-8375 | 150                | 115x280             | 5 | 24/240 |
| YT-8376 | 180                | 115x280             | 5 | 24/240 |
| YT-8377 | 240                | 115x280             | 5 | 24/240 |
| YT-8378 | 320                | 115x280             | 5 | 24/240 |

|         | grit / ziarnistość | size / rozmiar |       |  |
|---------|--------------------|----------------|-------|--|
| YT-8440 | 40                 | 115 mm x 5 m   | 12/48 |  |
| YT-8441 | 60                 | 115 mm x 5 m   | 12/48 |  |
| YT-8442 | 80                 | 115 mm x 5 m   | 12/48 |  |
| YT-8443 | 100                | 115 mm x 5 m   | 12/48 |  |
| YT-8444 | 120                | 115 mm x 5 m   | 12/48 |  |
| YT-8445 | 150                | 115 mm x 5 m   | 12/48 |  |
| YT-8446 | 180                | 115 mm x 5 m   | 12/48 |  |
| YT-8447 | 240                | 115 mm x 5 m   | 12/48 |  |
| YT-8448 | 320                | 115 mm x 5 m   | 12/48 |  |



POLYBAG



- application: paint, lacquer, filler, wood
- abrasive: aluminium oxide
- bond: synthetic resin
- backing: D
- coating: semi-open
- zastosowanie: farby, lakiery, szpachle, drewno
- ścierniwo: tlenek aluminium
- spoiwo: żywica syntetyczna
- podkład: D
- nasyp półotwarty

- application: paint, lacquer, filler, wood
- abrasive: aluminium oxide
- bond: synthetic resin
- backing: D
- coating: semi-open
- zastosowanie: farby, lakiery, szpachle, drewno
- ścierniwo: tlenek aluminium
- spoiwo: żywica syntetyczna
- podkład: D
- nasyp półotwarty

|         | grit / ziarnistość | size / rozmiar (mm) |    |     |
|---------|--------------------|---------------------|----|-----|
| YT-8360 | 40                 | 230x280             | 50 | 500 |
| YT-8361 | 60                 | 230x280             | 50 | 500 |
| YT-8362 | 80                 | 230x280             | 50 | 500 |
| YT-8363 | 100                | 230x280             | 50 | 500 |
| YT-8364 | 120                | 230x280             | 50 | 500 |
| YT-8365 | 150                | 230x280             | 50 | 500 |
| YT-8366 | 180                | 230x280             | 50 | 500 |
| YT-8367 | 240                | 230x280             | 50 | 500 |
| YT-8368 | 320                | 230x280             | 50 | 500 |

|         | grit / ziarnistość | size / rozmiar |   |  |
|---------|--------------------|----------------|---|--|
| YT-8458 | 40                 | 115 mm x 50 m  | 2 |  |
| YT-8459 | 60                 | 115 mm x 50 m  | 2 |  |
| YT-8460 | 80                 | 115 mm x 50 m  | 2 |  |
| YT-8461 | 100                | 115 mm x 50 m  | 2 |  |
| YT-8462 | 120                | 115 mm x 50 m  | 2 |  |
| YT-8463 | 150                | 115 mm x 50 m  | 2 |  |
| YT-8464 | 180                | 115 mm x 50 m  | 2 |  |
| YT-8465 | 240                | 115 mm x 50 m  | 2 |  |
| YT-8466 | 320                | 115 mm x 50 m  | 2 |  |

GB Sand paper PL Papier ścierny CZ Smirkový papír RO Hârtie abrazivă  
 D Schleifpapier RUS Наждачная бумага H Csiszolópapír E Papel de lija



- application: paint, lacquer, filler, wood
- abrasive: aluminium oxide
- bond: synthetic resin
- backing: F
- coating: closed

- zastosowanie: farby, lakiery, szpachle, drewno
- ścierniwo: tlenek aluminium
- spoiwo: żywica syntetyczna
- podkład: F
- nasyp pełny

- application: paint, lacquer, filler, wood
- abrasive: aluminium oxide
- bond: synthetic resin
- backing: F
- coating: closed

- zastosowanie: farby, lakiery, szpachle, drewno
- ścierniwo: tlenek aluminium
- spoiwo: żywica syntetyczna
- podkład: F
- nasyp pełny

|         | grit / ziarnistość | size / rozmiar |   |
|---------|--------------------|----------------|---|
| YT-8480 | 80                 | 150 mm x 50 m  | 2 |
| YT-8481 | 100                | 150 mm x 50 m  | 2 |
| YT-8482 | 120                | 150 mm x 50 m  | 2 |

|         | grit / ziarnistość | size / rozmiar |   |
|---------|--------------------|----------------|---|
| YT-8483 | 40                 | 200 mm x 50 m  | 2 |
| YT-8484 | 60                 | 200 mm x 50 m  | 2 |
| YT-8485 | 80                 | 200 mm x 50 m  | 2 |
| YT-8486 | 120                | 200 mm x 50 m  | 2 |

10

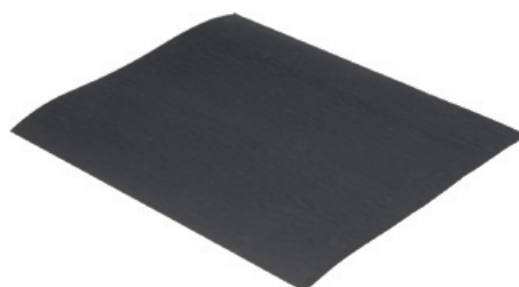

- application: paint, lacquer, filler
- abrasive: silicon carbide
- bond: synthetic resin
- backing: C
- coating: closed

- zastosowanie: farby, lakiery, szpachle
- ścierniwo: węglík krzemu
- spoiwo: żywica syntetyczna
- podkład: C
- nasyp pełny



- application: paint, lacquer, filler
- abrasive: silicon carbide
- bond: synthetic resin
- backing: A
- coating: closed

- zastosowanie: farby, lakiery, szpachle
- ścierniwo: węglík krzemu
- spoiwo: żywica syntetyczna
- podkład: A
- nasyp pełny



|         | grit / ziarnistość | size / rozmiar (mm) |    |     |
|---------|--------------------|---------------------|----|-----|
| YT-8400 | 60                 | 230x280             | 50 | 500 |
| YT-8401 | 80                 | 230x280             | 50 | 500 |
| YT-8402 | 100                | 230x280             | 50 | 500 |
| YT-8403 | 120                | 230x280             | 50 | 500 |
| YT-8404 | 150                | 230x280             | 50 | 500 |

|         | grit / ziarnistość | size / rozmiar (mm) |    |     |
|---------|--------------------|---------------------|----|-----|
| YT-8405 | 180                | 230x280             | 50 | 500 |
| YT-8406 | 220                | 230x280             | 50 | 500 |
| YT-8407 | 240                | 230x280             | 50 | 500 |
| YT-8408 | 280                | 230x280             | 50 | 500 |
| YT-8409 | 320                | 230x280             | 50 | 500 |
| YT-8410 | 360                | 230x280             | 50 | 500 |
| YT-8411 | 400                | 230x280             | 50 | 500 |
| YT-8412 | 500                | 230x280             | 50 | 500 |
| YT-8413 | 600                | 230x280             | 50 | 500 |
| YT-8414 | 800                | 230x280             | 50 | 500 |
| YT-8415 | 1000               | 230x280             | 50 | 500 |
| YT-8416 | 1200               | 230x280             | 50 | 500 |
| YT-8417 | 1500               | 230x280             | 50 | 500 |
| YT-8418 | 2000               | 230x280             | 50 | 500 |

POLYBAG



GB Abrasive cloth sheet CZ Brunsné plátno  
D Schleifgewebe blatt H Csiszolóvászon lap  
PL Plótno ściernie arkusz RO Coli panza abraziva  
RUS Шлифовальное полотно E Hojas de pano abrasivo



- application: metal, wood
- abrasive: aluminium oxide
- bond: semi-resin
- backing: J
- coating: close
- zastosowanie: metal, drewno
- ścierniwo: tlenek aluminium
- spoiwo: żywica
- podkład: J
- nasyp pełny

|          | grit / ziarnistość | size / rozmiar (mm) |    |     |
|----------|--------------------|---------------------|----|-----|
| YT-83160 | 36                 | 230x280             | 50 | 250 |
| YT-83161 | 40                 | 230x280             | 50 | 250 |
| YT-83162 | 60                 | 230x280             | 50 | 250 |
| YT-83163 | 80                 | 230x280             | 50 | 250 |
| YT-83164 | 100                | 230x280             | 50 | 250 |
| YT-83165 | 120                | 230x280             | 50 | 500 |
| YT-83166 | 150                | 230x280             | 50 | 500 |
| YT-83167 | 180                | 230x280             | 50 | 500 |
| YT-83168 | 220                | 230x280             | 50 | 500 |
| YT-83169 | 240                | 230x280             | 50 | 500 |

GB Abrasive cloth roll CZ Brunsné plátno role RO Rola panza abraziva  
D Schleifgewebe rolle H Csiszolóvászon tekercs E Rollo de pano abrasivo



- application: metal, wood
- abrasive: aluminium oxide
- bond: semi-resin
- backing: J
- coating: close
- zastosowanie: metal, drewno
- ścierniwo: tlenek aluminium
- spoiwo: żywica
- podkład: J
- nasyp pełny
- application: metal, wood
- abrasive: aluminium oxide
- bond: semi-resin
- backing: J
- coating: close
- zastosowanie: metal, drewno
- ścierniwo: tlenek aluminium
- spoiwo: żywica
- podkład: J
- nasyp pełny
- application: metal, wood
- abrasive: aluminium oxide
- bond: semi-resin
- backing: J
- coating: close
- zastosowanie: metal, drewno
- ścierniwo: tlenek aluminium
- spoiwo: żywica
- podkład: J
- nasyp pełny

|          | grit / ziarnistość | size / rozmiar |   |
|----------|--------------------|----------------|---|
| YT-83180 | 36                 | 150 mm x 30 m  | 2 |
| YT-83181 | 40                 | 150 mm x 30 m  | 2 |

|          | grit / ziarnistość | size / rozmiar |   |
|----------|--------------------|----------------|---|
| YT-83182 | 50                 | 150 mm x 50 m  | 2 |
| YT-83183 | 60                 | 150 mm x 50 m  | 2 |
| YT-83184 | 80                 | 150 mm x 50 m  | 2 |
| YT-83185 | 100                | 150 mm x 50 m  | 2 |
| YT-83186 | 120                | 150 mm x 50 m  | 2 |
| YT-83187 | 150                | 150 mm x 50 m  | 2 |
| YT-83188 | 180                | 150 mm x 50 m  | 2 |
| YT-83189 | 220                | 150 mm x 50 m  | 2 |
| YT-83190 | 240                | 150 mm x 50 m  | 2 |

|          | grit / ziarnistość | size / rozmiar |   |
|----------|--------------------|----------------|---|
| YT-83200 | 24                 | 200mm x 30 m   | 2 |
| YT-83201 | 36                 | 200mm x 30 m   | 2 |
| YT-83202 | 40                 | 200mm x 30 m   | 2 |
| YT-83203 | 50                 | 200mm x 30 m   | 2 |
| YT-83204 | 60                 | 200mm x 30 m   | 2 |
| YT-83205 | 80                 | 200mm x 30 m   | 2 |
| YT-83206 | 100                | 200mm x 30 m   | 2 |
| YT-83207 | 120                | 200mm x 30 m   | 2 |
| YT-83208 | 150                | 200mm x 30 m   | 2 |
| YT-83209 | 180                | 200mm x 30 m   | 2 |
| YT-83210 | 220                | 200mm x 30 m   | 2 |
| YT-83211 | 240                | 200mm x 30 m   | 2 |

GB No end abrasive band CZ Brusny pas RO Curea abraziva  
D Schleifband H Csiszoló szalag E Banda abrasiva sin fin



- application: metal, wood
- abrasive: aluminium oxide
- bond: synthetic resin
- coating: close
- zastosowanie: metal, drewno
- ścierniwo: tlenek aluminium
- spoiwo: żywica syntetyczna
- nasyp pełny
- application: metal, wood
- abrasive: aluminium oxide
- bond: synthetic resin
- coating: close
- zastosowanie: metal, drewno
- ścierniwo: tlenek aluminium
- spoiwo: żywica syntetyczna
- nasyp pełny
- application: metal, wood
- abrasive: aluminium oxide
- bond: synthetic resin
- coating: close
- zastosowanie: metal, drewno
- ścierniwo: tlenek aluminium
- spoiwo: żywica syntetyczna
- nasyp pełny

|          | grit / ziarnistość | size / rozmiar (mm) |   |       |
|----------|--------------------|---------------------|---|-------|
| YT-83220 | 36                 | 75x457              | 5 | 20/60 |
| YT-83221 | 40                 | 75x457              | 5 | 20/60 |
| YT-83222 | 60                 | 75x457              | 5 | 20/60 |
| YT-83223 | 80                 | 75x457              | 5 | 20/60 |
| YT-83224 | 100                | 75x457              | 5 | 20/60 |
| YT-83225 | 120                | 75x457              | 5 | 20/60 |
| YT-83226 | 150                | 75x457              | 5 | 20/60 |

|          | grit / ziarnistość | size / rozmiar (mm) |   |       |
|----------|--------------------|---------------------|---|-------|
| YT-83227 | 36                 | 75x533              | 5 | 20/60 |
| YT-83228 | 40                 | 75x533              | 5 | 20/60 |
| YT-83229 | 60                 | 75x533              | 5 | 20/60 |
| YT-83230 | 80                 | 75x533              | 5 | 20/60 |
| YT-83231 | 100                | 75x533              | 5 | 20/60 |
| YT-83232 | 120                | 75x533              | 5 | 20/60 |
| YT-83233 | 150                | 75x533              | 5 | 20/60 |

|          | grit / ziarnistość | size / rozmiar (mm) |   |       |
|----------|--------------------|---------------------|---|-------|
| YT-83234 | 36                 | 100x610             | 5 | 10/30 |
| YT-83235 | 40                 | 100x610             | 5 | 10/30 |
| YT-83236 | 60                 | 100x610             | 5 | 10/30 |
| YT-83237 | 80                 | 100x610             | 5 | 20/60 |
| YT-83238 | 100                | 100x610             | 5 | 20/60 |
| YT-83239 | 120                | 100x610             | 5 | 20/60 |
| YT-83240 | 150                | 100x610             | 5 | 20/60 |

GB Flap disc – regular shape  
D Fächerschleifscheibe - Gerade  
PL Ściernica listkowa talerzowa płaska  
RUS Круг лепестковый тарельчатый



- application: metal
- abrasive: aluminium oxide
- bond: synthetic resin
- backing: fibreglass
- zastosowanie: metal
- ścierniwo: tlenek aluminium
- spoiwo: żywica syntetyczna
- podkład: włókno szklane

| grit /<br>ziarnistość | size / rozmiar<br>(mm) |          |        |
|-----------------------|------------------------|----------|--------|
| YT-83251              | 36                     | 115x22.4 | 50/200 |
| YT-83252              | 40                     | 115x22.4 | 50/200 |
| YT-83253              | 60                     | 115x22.4 | 50/200 |
| YT-83254              | 80                     | 115x22.4 | 50/200 |
| YT-83255              | 100                    | 115x22.4 | 50/200 |
| YT-83256              | 120                    | 115x22.4 | 50/200 |

CZ Lamelový brusný kotouč  
H Lamellás csiszoló normál  
RO Disc lamelar frontal  
E Discos de paño abrasivo

GB Flap disc – regular shape  
D Fächerschleifscheibe - Gerade  
PL Ściernica listkowa talerzowa płaska  
RUS Круг лепестковый тарельчатый



- application: metal
- abrasive: aluminium oxide
- bond: synthetic resin
- backing: fibreglass
- zastosowanie: metal
- ścierniwo: tlenek aluminium
- spoiwo: żywica syntetyczna
- podkład: włókno szklane

| grit /<br>ziarnistość | size / rozmiar<br>(mm) |          |        |
|-----------------------|------------------------|----------|--------|
| YT-83271              | 36                     | 125x22.4 | 25/100 |
| YT-83272              | 40                     | 125x22.4 | 25/100 |
| YT-83273              | 60                     | 125x22.4 | 50/200 |
| YT-83274              | 80                     | 125x22.4 | 50/200 |
| YT-83275              | 100                    | 125x22.4 | 50/200 |
| YT-83276              | 120                    | 125x22.4 | 50/200 |

GB Flap disc – depressed shape  
D Fächerschleifscheibe - Gewölbt  
PL Ściernica listkowa talerzowa wypukła  
RUS Круг лепестковый тарельчатый



- application: metal
- abrasive: aluminium oxide
- bond: synthetic resin
- backing: fibreglass
- zastosowanie: metal
- ścierniwo: tlenek aluminium
- spoiwo: żywica syntetyczna
- podkład: włókno szklane

| grit /<br>ziarnistość | size / rozmiar<br>(mm) |          |        |
|-----------------------|------------------------|----------|--------|
| YT-83281              | 36                     | 115x22.4 | 50/200 |
| YT-83282              | 40                     | 115x22.4 | 50/200 |
| YT-83283              | 60                     | 115x22.4 | 50/200 |
| YT-83284              | 80                     | 115x22.4 | 50/200 |
| YT-83285              | 100                    | 115x22.4 | 50/200 |
| YT-83286              | 120                    | 115x22.4 | 50/200 |

CZ Lamelový brusný kotouč - vypouklý  
H Lamellás csiszoló dőntött  
RO Disc lamelar frontal depresat  
E Discos de paño abrasivo centro embudido

GB Flap disc – depressed shape  
D Fächerschleifscheibe - Gewölbt  
PL Ściernica listkowa talerzowa wypukła  
RUS Круг лепестковый тарельчатый



- application: metal
- abrasive: aluminium oxide
- bond: synthetic resin
- backing: fibreglass
- zastosowanie: metal
- ścierniwo: tlenek aluminium
- spoiwo: żywica syntetyczna
- podkład: włókno szklane

| grit /<br>ziarnistość | size / rozmiar<br>(mm) |          |        |
|-----------------------|------------------------|----------|--------|
| YT-83291              | 36                     | 125x22.4 | 25/100 |
| YT-83292              | 40                     | 125x22.4 | 25/100 |
| YT-83293              | 60                     | 125x22.4 | 50/200 |
| YT-83294              | 80                     | 125x22.4 | 50/200 |
| YT-83295              | 100                    | 125x22.4 | 50/200 |
| YT-83296              | 120                    | 125x22.4 | 50/200 |

GB Flap disc – regular shape  
D Fächerschleifscheibe - Gerade  
PL Ściernica listkowa talerzowa płaska  
RUS Круг лепестковый тарельчатый  
CZ Lamelový brusný kotouč



- application: metal, inox
- abrasive: zirconia aluminium oxide
- bond: synthetic resin
- backing: fibreglass
- zastosowanie: metal, stal nierdzewna
- ścierniwo: tlenek aluminium / dwutlenek cyrkonu
- spoiwo: żywica syntetyczna
- podkład: włókno szklane

| grit /<br>ziarnistość | size / rozmiar<br>(mm) |          |        |
|-----------------------|------------------------|----------|--------|
| YT-83301              | 36                     | 115x22.4 | 50/200 |
| YT-83302              | 40                     | 115x22.4 | 50/200 |
| YT-83303              | 60                     | 115x22.4 | 50/200 |
| YT-83304              | 80                     | 115x22.4 | 50/200 |
| YT-83305              | 100                    | 115x22.4 | 50/200 |
| YT-83306              | 120                    | 115x22.4 | 50/200 |

H Lamellás csiszoló normál  
RO Disc lamelar frontal  
E Discos de paño abrasivo

GB Flap disc – regular shape  
D Fächerschleifscheibe - Gerade  
PL Ściernica listkowa talerzowa płaska  
RUS Круг лепестковый тарельчатый  
CZ Lamelový brusný kotouč



- application: metal, inox
- abrasive: zirconia aluminium oxide
- bond: synthetic resin
- backing: fibreglass
- zastosowanie: metal, stal nierdzewna
- ścierniwo: tlenek aluminium / dwutlenek cyrkonu
- spoiwo: żywica syntetyczna
- podkład: włókno szklane

| grit /<br>ziarnistość | size / rozmiar<br>(mm) |          |        |
|-----------------------|------------------------|----------|--------|
| YT-83311              | 36                     | 125x22.4 | 25/100 |
| YT-83312              | 40                     | 125x22.4 | 25/100 |
| YT-83313              | 60                     | 125x22.4 | 25/100 |
| YT-83314              | 80                     | 125x22.4 | 50/200 |
| YT-83315              | 100                    | 125x22.4 | 50/200 |
| YT-83316              | 120                    | 125x22.4 | 50/200 |

H Lamellás csiszoló dőntött  
RO Disc lamelar frontal depresat  
E Discos de paño abrasivo centro embudido

GB Flap disc – depressed shape  
D Fächerschleifscheibe - Gewölbt  
PL Ściernica listkowa talerzowa wypukła  
RUS Круг лепестковый тарельчатый  
CZ Lamelový brusný kotouč - vypouklý



- application: metal, inox
- abrasive: zirconia aluminium oxide
- bond: synthetic resin
- backing: fibreglass
- zastosowanie: metal, stal nierdzewna
- ścierniwo: tlenek aluminium / dwutlenek cyrkonu
- spoiwo: żywica syntetyczna
- podkład: włókno szklane

| grit /<br>ziarnistość | size / rozmiar<br>(mm) |          |        |
|-----------------------|------------------------|----------|--------|
| YT-83321              | 36                     | 115x22.4 | 50/200 |
| YT-83322              | 40                     | 115x22.4 | 50/200 |
| YT-83323              | 60                     | 115x22.4 | 50/200 |
| YT-83324              | 80                     | 115x22.4 | 50/200 |
| YT-83325              | 100                    | 115x22.4 | 50/200 |
| YT-83326              | 120                    | 115x22.4 | 50/200 |

H Lamellás csiszoló dőntött  
RO Disc lamelar frontal depresat  
E Discos de paño abrasivo centro embudido

GB Flap disc – depressed shape  
D Fächerschleifscheibe - Gewölbt  
PL Ściernica listkowa talerzowa wypukła  
RUS Круг лепестковый тарельчатый  
CZ Lamelový brusný kotouč - vypouklý



- application: metal, inox
- abrasive: zirconia aluminium oxide
- bond: synthetic resin
- backing: fibreglass
- zastosowanie: metal, stal nierdzewna
- ścierniwo: tlenek aluminium / dwutlenek cyrkonu
- spoiwo: żywica syntetyczna
- podkład: włókno szklane

| grit /<br>ziarnistość | size / rozmiar<br>(mm) |          |        |
|-----------------------|------------------------|----------|--------|
| YT-83331              | 36                     | 125x22.4 | 25/100 |
| YT-83332              | 40                     | 125x22.4 | 25/100 |
| YT-83333              | 60                     | 125x22.4 | 25/100 |
| YT-83334              | 80                     | 125x22.4 | 50/200 |
| YT-83335              | 100                    | 125x22.4 | 50/200 |
| YT-83336              | 120                    | 125x22.4 | 50/200 |

H Lamellás csiszoló dőntött  
RO Disc lamelar frontal depresat  
E Discos de paño abrasivo centro embudido

## Cutting tools Narzędzia tnące

GB Flap wheel with shaft  
D Fächerschleifmop mit Schaft  
PL Ściernica listkowa trzpieniowa

RUS Круг лепестковый со шпинделем  
CZ Lamelový kotouč s hřídelí  
H Legyező csiszoló csapos

RO Perie abraziva circulara cu tija  
E Rueda laminar en tela abrasiva



- application: metal
- abrasive: aluminium oxide
- bond: synthetic resin
- zastosowanie: metal
- ścierniwo: tlenek aluminium
- spoiwo: żywica syntetyczna

| grit / ziarnistość | size / rozmiar (mm) |               |
|--------------------|---------------------|---------------|
| YT-83351           | 40                  | 40x20x6 10/60 |
| YT-83352           | 60                  | 40x20x6 10/60 |
| YT-83353           | 80                  | 40x20x6 10/60 |
| YT-83354           | 100                 | 40x20x6 10/60 |
| YT-83355           | 120                 | 40x20x6 10/60 |
| YT-83356           | 150                 | 40x20x6 10/60 |



- application: metal
- abrasive: aluminium oxide
- bond: synthetic resin
- zastosowanie: metal
- ścierniwo: tlenek aluminium
- spoiwo: żywica syntetyczna

| grit / ziarnistość | size / rozmiar (mm) |               |
|--------------------|---------------------|---------------|
| YT-83361           | 40                  | 60x30x6 10/60 |
| YT-83362           | 60                  | 60x30x6 10/60 |
| YT-83363           | 80                  | 60x30x6 10/60 |
| YT-83364           | 100                 | 60x30x6 10/60 |
| YT-83365           | 120                 | 60x30x6 10/60 |
| YT-83366           | 150                 | 60x30x6 10/60 |



- application: metal
- abrasive: aluminium oxide
- bond: synthetic resin
- zastosowanie: metal
- ścierniwo: tlenek aluminium
- spoiwo: żywica syntetyczna

| grit / ziarnistość | size / rozmiar (mm) |               |
|--------------------|---------------------|---------------|
| YT-83371           | 40                  | 80x30x6 10/60 |
| YT-83372           | 60                  | 80x30x6 10/60 |
| YT-83373           | 80                  | 80x30x6 10/60 |
| YT-83374           | 100                 | 80x30x6 10/60 |
| YT-83375           | 120                 | 80x30x6 10/60 |
| YT-83376           | 150                 | 80x30x6 10/60 |



- application: metal
- abrasive: aluminium oxide
- bond: synthetic resin
- zastosowanie: metal
- ścierniwo: tlenek aluminium
- spoiwo: żywica syntetyczna

| grit / ziarnistość | size / rozmiar (mm) |               |
|--------------------|---------------------|---------------|
| YT-83381           | 40                  | 80x40x6 10/60 |
| YT-83382           | 60                  | 80x40x6 10/60 |
| YT-83383           | 80                  | 80x40x6 10/60 |
| YT-83384           | 100                 | 80x40x6 10/60 |
| YT-83385           | 120                 | 80x40x6 10/60 |
| YT-83386           | 150                 | 80x40x6 10/60 |

GB Flap wheel with shaft  
D Fächerschleifmop mit Schaft  
PL Ściernica listkowa trzpieniowa  
RUS Круг лепестковый со шпинделем  
CZ Lamelový kotouč s hřídelí

H Legyező csiszoló csapos  
RO Perie abraziva circulara cu tija  
E Rueda laminar en tela abrasiva



- application: metal
- abrasive: aluminium oxide
- bond: synthetic resin

- zastosowanie: metal
- ścierniwo: tlenek aluminium
- spoiwo: żywica syntetyczna

- application: metal
- abrasive: aluminium oxide
- bond: synthetic resin

- zastosowanie: metal
- ścierniwo: tlenek aluminium
- spoiwo: żywica syntetyczna

- application: metal
- abrasive: aluminium oxide
- bond: synthetic resin

- zastosowanie: metal
- ścierniwo: tlenek aluminium
- spoiwo: żywica syntetyczna

| grit / ziarnistość | size / rozmiar (mm) |               |
|--------------------|---------------------|---------------|
| YT-83390           | 60                  | 50x30x6 10/60 |
| YT-83391           | 100                 | 50x30x6 10/60 |
| YT-83392           | 150                 | 50x30x6 10/60 |
| YT-83393           | 200                 | 50x30x6 10/60 |

| grit / ziarnistość | size / rozmiar (mm) |               |
|--------------------|---------------------|---------------|
| YT-83394           | 60                  | 60x50x6 10/60 |
| YT-83395           | 100                 | 60x50x6 10/60 |
| YT-83396           | 150                 | 60x50x6 10/60 |
| YT-83397           | 200                 | 60x50x6 10/60 |

| grit / ziarnistość | size / rozmiar (mm) |               |
|--------------------|---------------------|---------------|
| YT-83398           | 60                  | 80x50x6 10/60 |
| YT-83399           | 100                 | 80x50x6 10/60 |
| YT-83400           | 150                 | 80x50x6 10/60 |
| YT-83401           | 200                 | 80x50x6 10/60 |

GB Abrasive disc  
D Schleifpapier zum Gummiteiler  
PL Krążek ścierny  
RUS Круг шлифовальный  
CZ Brusný kotouč  
H Csiszolótárcsa  
RO Disc abraziv  
E Juego de discos abrasivos

TIED ON CARD



- application: metal, wood
- abrasive: aluminium oxide
- bond: synthetic resin
- backing: C
- coating: semi-open
- zastosowanie: metal, drewno
- ścierniwo: tlenek aluminium
- spoiwo: żywica syntetyczna
- podkład: C
- nasyp półotwarty



|          | grit /<br>ziarnistość | (mm) |        |
|----------|-----------------------|------|--------|
| YT-83420 | 36                    | 115  | 50/200 |
| YT-83421 | 40                    | 115  | 50/200 |
| YT-83422 | 60                    | 115  | 50/200 |
| YT-83423 | 80                    | 115  | 50/200 |
| YT-83424 | 100                   | 115  | 50/200 |
| YT-83425 | 120                   | 115  | 50/200 |
| YT-83426 | 150                   | 115  | 50/200 |
| YT-83427 | 180                   | 115  | 50/200 |
| YT-83428 | 220                   | 115  | 50/200 |

GB Abrasive disc  
D Schleifpapier zum Gummiteiler  
PL Krążek ścierny  
RUS Круг шлифовальный  
CZ Brusný kotouč  
H Csiszolótárcsa  
RO Disc abraziv  
E Juego de discos abrasivos

TIED ON CARD



- application: metal, wood
- abrasive: aluminium oxide
- bond: synthetic resin
- backing: C
- coating: semi-open
- zastosowanie: metal, drewno
- ścierniwo: tlenek aluminium
- spoiwo: żywica syntetyczna
- podkład: C
- nasyp półotwarty



|          | grit /<br>ziarnistość | (mm) |        |
|----------|-----------------------|------|--------|
| YT-83430 | 36                    | 125  | 50/200 |
| YT-83431 | 40                    | 125  | 50/200 |
| YT-83432 | 60                    | 125  | 50/200 |
| YT-83433 | 80                    | 125  | 50/200 |
| YT-83434 | 100                   | 125  | 50/200 |
| YT-83435 | 120                   | 125  | 50/200 |
| YT-83436 | 150                   | 125  | 50/200 |
| YT-83437 | 180                   | 125  | 50/200 |
| YT-83438 | 220                   | 125  | 50/200 |

GB Abrasive disc with holes  
D Schleifpapier zum Gummiteiler mit lochen  
PL Krążek ścierny z otworami  
RUS Круг шлифовальный перфорированный с липучкой  
CZ Brusný kotouč z otvorama  
H Fibertárcsa lyukakkal tépőzárás  
RO Disc abraziv cu orificii  
E Juego de discos abrasivos con agujeros

TIED ON CARD



- application: metal, wood
- abrasive: aluminium oxide
- bond: synthetic resin
- backing: C
- coating: semi-open
- zastosowanie: metal, drewno
- ścierniwo: tlenek aluminium
- spoiwo: żywica syntetyczna
- podkład: C
- nasyp półotwarty



|          | grit /<br>ziarnistość | (mm) |        |
|----------|-----------------------|------|--------|
| YT-83440 | 36                    | 115  | 50/200 |
| YT-83441 | 40                    | 115  | 50/200 |
| YT-83442 | 60                    | 115  | 50/200 |
| YT-83443 | 80                    | 115  | 50/200 |
| YT-83444 | 100                   | 115  | 50/200 |
| YT-83445 | 120                   | 115  | 50/200 |
| YT-83446 | 150                   | 115  | 50/200 |
| YT-83447 | 180                   | 115  | 50/200 |
| YT-83448 | 220                   | 115  | 50/200 |

GB Abrasive disc with holes  
D Schleifpapier zum Gummiteiler mit lochen  
PL Krążek ścierny z otworami  
RUS Круг шлифовальный перфорированный с липучкой  
CZ Brusný kotouč z otvorama  
H Fibertárcsa lyukakkal tépőzárás  
RO Disc abraziv cu orificii  
E Juego de discos abrasivos con agujeros

TIED ON CARD



- application: metal, wood
- abrasive: aluminium oxide
- bond: synthetic resin
- backing: C
- coating: semi-open
- zastosowanie: metal, drewno
- ścierniwo: tlenek aluminium
- spoiwo: żywica syntetyczna
- podkład: C
- nasyp półotwarty



|          | grit /<br>ziarnistość | (mm) |        |
|----------|-----------------------|------|--------|
| YT-83450 | 36                    | 125  | 50/200 |
| YT-83451 | 40                    | 125  | 50/200 |
| YT-83452 | 60                    | 125  | 50/200 |
| YT-83453 | 80                    | 125  | 50/200 |
| YT-83454 | 100                   | 125  | 50/200 |
| YT-83455 | 120                   | 125  | 50/200 |
| YT-83456 | 150                   | 125  | 50/200 |
| YT-83457 | 180                   | 125  | 50/200 |
| YT-83458 | 220                   | 125  | 50/200 |

GB Abrasive sheet with holes  
D Schleifgewebe-scheiben mit lochen  
PL Arkusz ścierny z otworami  
RUS Шлифовальная перфорированная бумага для виброшлифмашинки  
CZ Brusné archy z otvorama  
H Csiszoló lap lyukakkal  
RO Coale (foi) abrazive cu orificii  
E Ojas abrasivas con agujeros

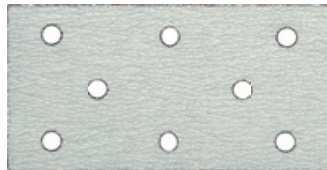

- application: paint, lacquer, filler
- abrasive: aluminium oxide
- bond: synthetic resin
- backing: C
- coating: semi-open
- zastosowanie: farby, lakiery, szpachle
- ścierniwo: tlenek aluminium
- spoiwo: żywica syntetyczna
- podkład: C
- nasyp półotwarty

TIED ON CARD



|          | grit /<br>ziarnistość | size /<br>rozmiar<br>(mm) |        |
|----------|-----------------------|---------------------------|--------|
| YT-83480 | 40                    | 93x180                    | 25/100 |
| YT-83481 | 60                    | 93x180                    | 25/100 |
| YT-83482 | 80                    | 93x180                    | 25/100 |
| YT-83483 | 100                   | 93x180                    | 25/100 |
| YT-83484 | 120                   | 93x180                    | 25/100 |
| YT-83485 | 150                   | 93x180                    | 50/200 |
| YT-83486 | 180                   | 93x180                    | 50/200 |
| YT-83487 | 220                   | 93x180                    | 50/200 |
| YT-83488 | 240                   | 93x180                    | 50/200 |

GB Abrasive sheet with holes  
D Schleifgewebe-scheiben mit lochen  
PL Arkusz ścierny z otworami  
RUS Шлифовальная перфорированная бумага для виброшлифмашинки  
CZ Brusné archy z otvorama  
H Csiszoló lap lyukakkal  
RO Coale (foi) abrazive cu orificii  
E Ojas abrasivas con agujeros

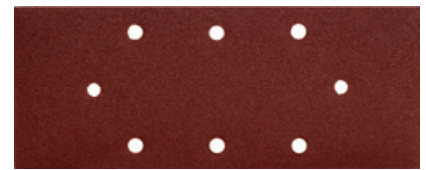

- application: metal, wood
- abrasive: aluminium oxide
- bond: synthetic resin
- backing: C
- coating: semi-open
- zastosowanie: metal, drewno
- ścierniwo: tlenek aluminium
- spoiwo: żywica syntetyczna
- podkład: C
- nasyp półotwarty

TIED ON CARD



|          | grit /<br>ziarnistość | size /<br>rozmiar<br>(mm) |        |
|----------|-----------------------|---------------------------|--------|
| YT-83490 | 40                    | 93x230                    | 25/100 |
| YT-83491 | 60                    | 93x230                    | 25/100 |
| YT-83492 | 80                    | 93x230                    | 25/100 |
| YT-83493 | 100                   | 93x230                    | 25/100 |
| YT-83494 | 120                   | 93x230                    | 25/100 |
| YT-83495 | 150                   | 93x230                    | 25/100 |
| YT-83496 | 180                   | 93x230                    | 25/100 |
| YT-83497 | 220                   | 93x230                    | 25/100 |
| YT-83498 | 240                   | 93x230                    | 25/100 |

GB Sanding block  
D Handschleifer  
PL Blok ścierny  
RUS Брусок для шлифования  
CZ Brusný blok  
H Suport smirghel  
RO Csiszolóblokk  
E Bloque abrasivo



TIED ON CARD



|         | mm      |      |
|---------|---------|------|
| YT-5320 | 223x85  | 6/36 |
| YT-5321 | 223x105 | 6/36 |



Memo

# 11

## Hydraulic tools Narzędzia hydrauliczne



## Hydraulic tools Narzędzia hydrauliczne

Ratchet die stock sets  
Komplety gwintownic ręcznych

212



Water pump pliers  
Szczypcy nastawne

213



Accessories for ratchet die stock  
Akcesoria do gwintownic ręcznych

212



Pipe cutters  
Obcinaki do rur

214



Pipe wrenches  
Klucze do rur

212-213



Hand flaring tools sets  
Praski do rozszerzania rur

215



- GB Ratchet die stock
- D Handgewindebohrer
- PL Gwintownica ręczna
- RUS Ручный метчик
- CZ Závitník
- H Menetfűrő
- RO Tarozii
- E Machos de rosca



BMC & COLOR SLEEVE

| size / rozmiar |   |  |   |
|----------------|---|--|---|
| YT-2900        | 1/4" (6.3 mm); 3/8" (10.0 mm); 1/2" (12.5 mm); 3/4" (19.0 mm); 1" (25.0 mm); 5/4" (32.0 mm) |  | 4 |

- GB Spare knives for ratchet die stock
- D Rohrgewinde-Schneidbacken
- PL Noże zapasowe do gwintownicy ręcznej
- RUS Запасные ножи для оправки
- CZ Náhradní nože do ručního závitofezu
- H Tartalék kések, racsnis csömenetvágóhoz
- RO Cutit de rezerva pt. filiera
- E Filos de recambio para terraja de mano



POLYBAG WITH HEADER

| size / rozmiar |                |   |        |
|----------------|----------------|---|--------|
| YT-2910        | 1/4" (6.3 mm)  | 4 | 50/200 |
| YT-2911        | 3/8" (10.0 mm) | 4 | 50/200 |
| YT-2912        | 1/2" (12.5 mm) | 4 | 50/200 |
| YT-2913        | 3/4" (19.0 mm) | 4 | 50/200 |
| YT-2914        | 1" (25.0 mm)   | 4 | 50/200 |

- GB Spare head for ratchet die stock
- D Rohrgewinde-Schneidköpfe
- PL Głowica zapasowa do gwintownicy ręcznej
- RUS Запасная оправка для нарезания трубной резьбы
- CZ Náhradní hlava pro ruční závitofez
- H Tartalék fej, racsnis csömenetvágóhoz
- RO Cap de rezerva pt. placa filetat cu clichet
- E Cabeza de recambio para terraja de mano



COLOR BOX

| size / rozmiar |                |  |       |
|----------------|----------------|--|-------|
| YT-2916        | 1/4" (6.3 mm)  |  | 10/40 |
| YT-2917        | 3/8" (10.0 mm) |  | 10/40 |
| YT-2918        | 1/2" (12.5 mm) |  | 10/40 |
| YT-2919        | 3/4" (19.0 mm) |  | 10/40 |
| YT-2920        | 1" (25.0 mm)   |  | 10/40 |
| YT-2921        | 5/4" (32.0 mm) |  | 10/40 |

11

- GB Adjustable pipe wrench
- D Rohrschlüssel
- PL Klucz nastawny do rur
- RUS Ключ трубный переставной
- CZ Nastavitelný klíč na trubky
- H Állítható csőkulcs
- RO Cheie reglabilă pt. țevi
- E Llave para tubos tipo Inglesa



COLOR BOX



| max. pipe diameter / max. średnica rury |              |     |  | L (mm) |  |
|---|--------------|-----|--|--------|--|
| YT-2210                                 | 1" (25 mm)   | 320 |  | 24     |  |
| YT-2211                                 | 1.5" (38 mm) | 420 |  | 18     |  |
| YT-2212                                 | 2" (50 mm)   | 560 |  | 12     |  |

- GB Adjustable pipe wrench
- D Rohrschlüssel
- PL Klucz nastawny do rur
- RUS Ключ трубный переставной
- CZ Nastavitelný klíč na trubky
- H Állítható csőkulcs
- RO Cheie reglabilă pt. țevi
- E Llave para tubos tipo Inglesa



COLOR BOX



| max. pipe diameter / max. średnica rury |              |     |  | L (mm) |  |
|---|--------------|-----|--|--------|--|
| YT-2213                                 | 1" (25 mm)   | 330 |  | 24     |  |
| YT-2214                                 | 1.5" (38 mm) | 415 |  | 18     |  |
| YT-2215                                 | 2" (50 mm)   | 530 |  | 12     |  |

- GB Adjustable pipe wrench
- D Rohrschlüssel
- PL Klucz nastawny do rur
- RUS Ключ трубный переставной
- CZ Nastavitelný klíč na trubky
- H Állítható csőkulcs
- RO Cheie reglabilă pt. țevi
- E Llave para tubos tipo Inglesa



COLOR BOX



| max. pipe diameter / max. średnica rury |              |     |  | L (mm) |  |
|---|--------------|-----|--|--------|--|
| YT-2216                                 | 1" (25 mm)   | 330 |  | 24     |  |
| YT-2217                                 | 1.5" (38 mm) | 420 |  | 18     |  |
| YT-2218                                 | 2" (50 mm)   | 535 |  | 12     |  |

## Hydraulic tools Narzędzia hydrauliczne

GB Pipe wrench  
D Rohrschlüssel  
PL Klucz do rur

RUS Ключ трубный  
CZ Klič součásti na trubky

H Csőkulcs  
RO Cheie reglabila pt. tevi  
E Llave para tubos



| size / rozmiar | max. pipe diameter / max. średnica rury |                   |
|----------------|---|-------------------|
| YT-2480*       | 10" (250 mm)                            | 1" (25 mm) 6/30   |
| YT-2481        | 12" (300 mm)                            | 1.5" (38 mm) 6/18 |
| YT-2482        | 14" (350 mm)                            | 2" (50 mm) 6/12   |
| YT-2483        | 18" (450 mm)                            | 2.5" (63 mm) 2/10 |
| YT-2484        | 24" (600 mm)                            | 3" (75 mm) 2/6    |
| YT-2485        | 36" (900 mm)                            | 5" (125 mm) 3     |
| YT-2486*       | 48" (1200 mm)                           | 6" (150 mm) 2     |

\* - product not for european market  
\* - produkt nieprzeznaczony na rynek europejski



| size / rozmiar | max. pipe diameter / max. średnica rury |                   |
|----------------|---|-------------------|
| YT-2487*       | 8" (200 mm)                             | 3/4" (19 mm) 6/30 |
| YT-2488        | 10" (250 mm)                            | 1" (25 mm) 6/18   |
| YT-2489        | 12" (300 mm)                            | 1.5" (38 mm) 6/12 |
| YT-2490        | 14" (350 mm)                            | 2" (50 mm) 2/10   |
| YT-2491        | 18" (450 mm)                            | 2.5" (63 mm) 3/6  |
| YT-2492        | 24" (600 mm)                            | 3" (75 mm) 2/4    |
| YT-2493        | 36" (900 mm)                            | 5" (125 mm) 1     |
| YT-2494        | 48" (1200 mm)                           | 6" (150 mm) 1     |
| YT-2495        | 60" (1500 mm)                           | 8" (200 mm) 1     |

GB Pipe wrench  
D Rohrschlüssel  
PL Klucz do rur

RUS Ключ трубный  
CZ Klič součásti na trubky

H Csőkulcs  
RO Cheie reglabila pt. tevi  
E Llave para tubos



| size / rozmiar | max. pipe diameter / max. średnica rury |                   |
|----------------|---|-------------------|
| YT-2201        | 10" (250 mm)                            | 1" (25 mm) 6/36   |
| YT-2203        | 14" (350 mm)                            | 1.5" (38 mm) 4/16 |
| YT-2204        | 18" (450 mm)                            | 2" (50 mm) 3/12   |
| YT-2205        | 24" (600 mm)                            | 2.5" (63 mm) 3/6  |
| YT-2206        | 36" (900 mm)                            | 4" (100 mm) 2/4   |

GB Pipe wrench  
D Rohrschlüssel  
PL Klucz do rur

RUS Ключ трубный  
CZ Klič součásti na trubky

H Csőkulcs  
RO Cheie reglabila pt. tevi  
E Llave para tubos



| size / rozmiar | max. pipe diameter / max. średnica rury |                   |
|----------------|---|-------------------|
| YT-2222        | 12" (300 mm)                            | 1" (25 mm) 6/24   |
| YT-2223        | 14" (350 mm)                            | 1.5" (38 mm) 4/16 |
| YT-2224        | 18" (450 mm)                            | 2" (50 mm) 3/12   |
| YT-2225        | 24" (600 mm)                            | 2.5" (63 mm) 3/6  |

| size / rozmiar | max. pipe diameter / max. średnica rury |                   |
|----------------|---|-------------------|
| YT-2226*       | 10" (250 mm)                            | 1.7" (43 mm) 6/24 |

\* - product not for european market  
\* - produkt nieprzeznaczony na rynek europejski

GB Adjustable pliers  
D Verstellbare Kombizange  
PL Szczypce przestawne  
RUS Переставные клещи

CZ Kleště přestavitelné  
H Állítható fogó  
RO Cleste pivot  
E Pinzas ajustables



\* - product not for european market  
\* - produkt nieprzeznaczony na rynek europejski



| L (mm)   | max. working range / max. rozstaw (mm) |            |
|----------|--|------------|
| YT-1957  | 150                                    | 65-70 6/60 |
| YT-1958* | 200                                    | 70-80 6/60 |

GB Water pump pliers  
D Wasserpumpenzange  
PL Szczypce nastawne  
RUS Клещи переставные  
CZ Keleště siko

H Vizpumpafagó  
RO Cleste papagal  
E Alicates de fontanero ajustables



| L (mm)  |          |
|---------|----------|
| YT-2090 | 250 6/36 |
| YT-2091 | 300 6/36 |

GB Water pump pliers  
D Wasserpumpenzange  
PL Szczypce nastawne  
RUS Клещи переставные  
CZ Keleště siko

H Vizpumpafagó  
RO Cleste papagal  
E Alicates de fontanero ajustables



| L (mm)  |          |
|---------|----------|
| YT-2069 | 250 6/36 |



| L (mm)  |          |
|---------|----------|
| YT-2070 | 250 6/24 |

GB PVC pipe cutter  
 D PVC Rohrabscneider  
 PL Obcinak do rur PCV  
 RUS Труборез для ПВХ труб

CZ Řezač PVC trubek  
 H Csővágó olló PVC csövekhez  
 RO Clește pt. tăiat țevi din PVC  
 E Cortatubos PVC

SLIDING  
 CARD



|         | max. (mm) |      |
|---------|-----------|------|
| YT-2230 | 35        | 6/48 |

|         | max. (mm) |      |
|---------|-----------|------|
| YT-2231 | 42        | 6/48 |



|         | max. (mm) |      |
|---------|-----------|------|
| YT-2228 | 51        | 6/24 |

|         | max. (mm) |      |
|---------|-----------|------|
| YT-2229 | 64        | 6/24 |

GB Pipe cutter  
 D Rohrabscneider  
 PL Obcinak do rur  
 RUS Труборіз для труб  
 CZ Řezač trubek  
 H Csővágó olló csövekhez  
 RO Clește pt. tăiat țevi  
 E Cortatubos

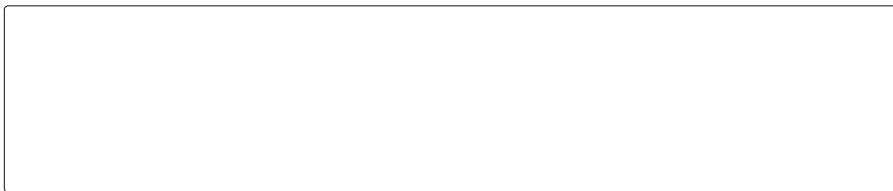

COLOR BOX



|         | 3/8"-1-5/8" (10-40 mm) |    |
|---------|------------------------|----|
| YT-2232 |                        | 20 |

|         | 1/4"-7/4" (6-45 mm) |    |
|---------|---------------------|----|
| YT-2233 |                     | 25 |



|         | 1/2"-5/2" (14-63 mm) |    |
|---------|----------------------|----|
| YT-2234 |                      | 25 |

|         | 2"-5" (50-127 mm) |    |
|---------|-------------------|----|
| YT-2235 |                   | 10 |

## Hydraulic tools Narzędzia hydrauliczne

- GB** Hand flaring tools set  
**D** Handpresse zum Aufweiten von Rohren  
**PL** Praska do ręcznego rozszerzania rur  
**RUS** Пресс для ручного расширения труб
- CZ** Přípravek na ruční rozšiřování konců trubek  
**H** Kézi csőtágító  
**RO** Presă manuală pt. lățirea țevilor  
**E** Prensa para la elongación manual de tubos

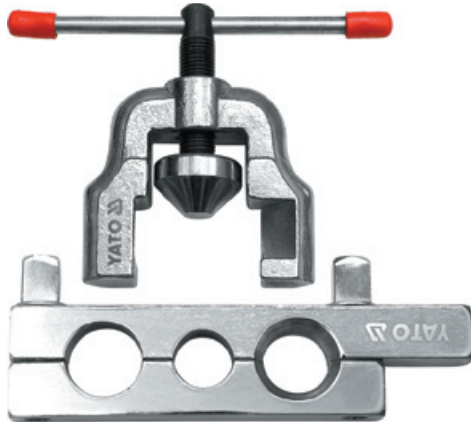

COLOR BOX

|         | (mm)       |    |
|---------|------------|----|
| YT-2181 | 19; 22; 25 | 20 |
| YT-2182 | 22; 25; 28 | 20 |

- GB** Hand flaring tools set  
**D** Handpresse zum Aufweiten von Rohren  
**PL** Praska do ręcznego rozszerzania rur  
**RUS** Пресс для ручного расширения труб
- CZ** Přípravek na ruční rozšiřování konců trubek  
**H** Kézi csőtágító  
**RO** Presă manuală pt. lățirea țevilor  
**E** Prensa para la elongación manual de tubos



BMC & COLOR SLEEVE

|         | (mm)                               |    |
|---------|------------------------------------|----|
| YT-2180 | 3; 5; 6; 8; 10; 12; 14; 15; 16; 19 | 10 |

- GB** Hand flaring tools set  
**D** Zange zum Aufweiten von Rohrenden von Hand  
**PL** Szczypce do kielichowania ręcznego  
**RUS** Щипцы для формирования раструбов вручную
- CZ** Kleště na ruční hrdlování konců trubek  
**H** Csőtágító fogó  
**RO** Clește pt. manșonare manuală  
**E** Pinzas para abocinamiento manual de tubos



BMC & COLOR SLEEVE

|         | size / rozmiar   |   |
|---------|--|---|
| YT-2183 | 1/2" (12.7 mm); 5/8" (15.9 mm); 3/4" (19.0 mm); 7/8" (22.2 mm); 1" (25.4 mm); 9/8" (28.6 mm) | 5 |

# 12

## Fastening tools Narzędzia do łączenia



**YATO**  
YATO S.A. Spółka z ograniczoną odpowiedzialnością  
ul. Słowackiego 12, 17-100 Suwałki, woj. podlaskie, Polska  
NIP: 525-200-10-10, REGON: 141907, KRS: 0000430202  
Sąd Rejestrowy: Sąd Rejestrowy w Suwałkach, Krajowy Rejestr Sądowy  
Krajowa Izba Gospodarcza, Sąd Gospodarczy, Krajowy Rejestr Sądowy  
Krajowa Izba Gospodarcza, Sąd Gospodarczy, Krajowy Rejestr Sądowy

Item number: YF-0922  
P<sub>max</sub> = 8bar 1/4" 1.9 Kg  
CE  
YATO S.A. Spółka z ograniczoną odpowiedzialnością  
ul. Słowackiego 12, 17-100 Suwałki, woj. podlaskie, Polska  
NIP: 525-200-10-10, REGON: 141907, KRS: 0000430202  
Sąd Rejestrowy: Sąd Rejestrowy w Suwałkach, Krajowy Rejestr Sądowy  
Krajowa Izba Gospodarcza, Sąd Gospodarczy, Krajowy Rejestr Sądowy



Hand riveters & rivets  
Nitownice ręczne i nity

218-220



Mini palm nailers  
Młotki pneumatyczne do gwoździ

223



Hand riveters

Nitownice ręczne..... 218

Lazy tong riveters

Nitownice ręczne, dźwigniowe..... 218

Hand nut tools

Nitownice do nitonakrętek..... 219

Aluminium blind rivets

Nity aluminiowe..... 220

Gas framing nailers & accessories  
Gwoździarki gazowe i akcesoria

223



Foam guns

Pistolety do pianki

224



Pneumatic riveters

Nitownice pneumatyczne

220



Caulking guns

Wyciskacze do mas

224-225



Staple guns & staples

Zszywacze i zszywki

221



Burners & soldering tools

Palniki i lutownice

225-226



Staple guns

Zszywacze..... 221

Staple removers

Rozszywacze..... 221

Staples

Zszywki..... 221

Nails

Gwoździe..... 221

Glue guns

Pistolety do klejenia

227



Pneumatic stitching & nailing machines

Zszywacze i gwoździarki pneumatyczne

222-223



Pneumatic staplers

Zszywacze pneumatyczne..... 222

Pneumatic nailers

Gwoździarki pneumatyczne..... 222

Staples

Zszywki..... 223

Nails

Gwoździe..... 223

- GB Hand riveter  
 D Blindnietzange  
 PL Nitownica ręczna  
 RUS Заклепочник  
 CZ Ruční nýtovačka
- H Kézi popszegecshűző  
 RO Presă de nituit manuală  
 E Remachadora de mano



|         | (mm)               | L (mm) |      |
|---------|--------------------|--------|------|
| YT-3600 | 2.4; 3.2; 4.0; 4.8 | 280    | 6/24 |

|         | (mm)               | L (mm) |      |
|---------|--------------------|--------|------|
| YT-3601 | 2.4; 3.2; 4.0; 4.8 | 250    | 6/24 |

- GB Hand riveter  
 D Blindnietzange  
 PL Nitownica ręczna  
 RUS Заклепочник
- CZ Ruční nýtovačka  
 H Kézi popszegecshűző  
 RO Presă de nituit manuală  
 E Remachadora de mano



|          | (mm)               | L (mm) |    |
|----------|--------------------|--------|----|
| YT-36012 | 2.4; 3.2; 4.0; 4.8 | 200    | 30 |

- GB Hand riveter  
 D Blindnietzange  
 PL Nitownica ręczna z głowicą obrotową  
 RUS Заклепочник  
 CZ Ruční nýtovačka  
 H Kézi popszegecshűző  
 RO Presă de nituit manuală  
 E Remachadora de mano



|          | (mm)               | L (mm) |       |
|----------|--------------------|--------|-------|
| YT-36011 | 2.4; 3.2; 4.0; 4.8 | 253    | 12/36 |

12

- GB Lazy tongue riveter  
 D Blindnietzange  
 PL Nitownica dźwigniowa  
 RUS Заклепочник  
 CZ Nýtovačka páková
- H Emeltyűs popszegecshűző  
 RO Pclește pt. popnituri  
 E Remachadora de palanca



|         | (mm)                    | L (mm) |    |
|---------|-------------------------|--------|----|
| YT-3609 | 3.2; 4.0; 4.8; 6.0; 6.4 | 330    | 16 |

- GB Lazy tongue riveter  
 D Blindnietzange  
 PL Nitownica dźwigniowa z głowicą obrotową  
 RUS Заклепочник
- CZ Nýtovačka páková  
 H Emeltyűs popszegecshűző  
 RO Pclește pt. popnituri  
 E Remachadora de palanca



|          | (mm)               | L (mm) |    |
|----------|--------------------|--------|----|
| YT-36092 | 3.2; 4.0; 4.8; 6.4 | 328    | 12 |

- GB Lazy tongue riveter  
D Blindnietzange  
PL Nitownica dźwigniowa  
RUS Заклепочник  
CZ Nýtovačka páková
- H Emeltyűs popszegecshűző  
RO Pclește pt. popnituri  
E Remachadora de palanca



|          | (mm)                    | L (mm) |
|----------|-------------------------|--------|
| YT-36095 | 2.4; 3.2; 4.0; 4.8; 6.4 | 380 12 |

- GB Lazy tongue riveter  
D Blindnietzange  
PL Nitownica dźwigniowa  
RUS Заклепочник  
CZ Nýtovačka páková
- H Emeltyűs popszegecshűző  
RO Pclește pt. popnituri  
E Remachadora de palanca



|         | (mm)                    | L (mm) |
|---------|-------------------------|--------|
| YT-3610 | 3.2; 4.0; 4.8; 6.0; 6.4 | 525 12 |

- GB Hand nut tool  
D Blindnietzange  
PL Nitownica ręczna do nitonakrętek  
RUS Заклепочник  
CZ Nýtovačka páková
- H Emeltyűs popszegecshűző  
RO Pclește pt. popnituri  
E Remachadora de palanca



|         | size / rozmiar      | L (mm) |
|---------|---------------------|--------|
| YT-3613 | M4; M5; M6; M8; M10 | 440 10 |

- GB Hand nut tool  
D Blindnietzange  
PL Nitownica ręczna do nitonakrętek
- RUS Заклепочник  
CZ Nýtovačka páková  
H Emeltyűs popszegecshűző
- RO Pclește pt. popnituri  
E Remachadora de palanca



|         | size / rozmiar       | L (mm) |
|---------|----------------------|--------|
| YT-3612 | M5; M6; M8; M10; M12 | 330 5  |

GB Hand nut tool  
 D Blindnietzange  
 PL Nitownica ręczna do nitonakrętek  
 RUS Заклепочник  
 CZ Nýtovačka páková

H Emeltyűs popszegecshűző  
 RO Pclește pt. popnituri  
 E Remachadora de palanca



BMC & COLOR SLEEVE



|          | size / rozmiar       | L (mm) |
|----------|----------------------|--------|
| YT-36119 | M5; M6; M8; M10; M12 | 338 6  |

GB Hand nut tool  
 D Blindnietzange  
 PL Nitownica ręczna do nitonakrętek  
 RUS Заклепочник  
 CZ Nýtovačka páková

H Emeltyűs popszegecshűző  
 RO Pclește pt. popnituri  
 E Remachadora de palanca



BMC & COLOR SLEEVE



|          | size / rozmiar               | L (mm) |
|----------|------------------------------|--------|
| YT-36129 | M3; M4; M5; M6; M8; M10; M12 | 410 5  |

GB Aluminium blind rivets  
 D Aluminiumblindnieten  
 PL Nity aluminiowe

RUS Алюминиевые заклёпки  
 CZ Hliníkové nýty  
 H Alu popszegecs

RO Nituri din aluminiu  
 E Remaches de aluminio



DOUBLE BLISTER



|         | (mm) | L (mm)        |
|---------|------|---------------|
| YT-3630 | 3.2  | 6.4 50 12/48  |
| YT-3631 | 3.2  | 9.6 50 12/48  |
| YT-3632 | 3.2  | 12.7 50 12/48 |
| YT-3634 | 4.0  | 6.4 50 12/48  |
| YT-3635 | 4.0  | 9.6 50 12/48  |
| YT-3636 | 4.0  | 12.7 50 12/48 |

|         | (mm) | L (mm)        |
|---------|------|---------------|
| YT-3637 | 4.0  | 19.0 50 12/48 |
| YT-3639 | 4.8  | 6.4 50 12/48  |
| YT-3640 | 4.8  | 9.6 50 12/48  |
| YT-3641 | 4.8  | 12.7 50 12/48 |
| YT-3642 | 4.8  | 19.0 50 12/48 |

12

GB Pneumatic riveting machine  
 D Pneumatische Nietvorrichtung  
 PL Nitownica pneumatyczna  
 RUS Пневматический заклепочник

CZ Pneumatická nýtovačka  
 H Pneumatikus popszegecshűző  
 RO Presa pneumatica de nituri  
 E Máquina remachadora

COLOR BOX



- application: industry
- przeznaczenie: przemysł

- application: industry
- przeznaczenie: przemysł

|         | (mm)               | L (mm) | F (kg) | F (N)   |
|---------|--------------------|--------|--------|---------|
| YT-3617 | 2.4; 3.2; 4.0; 4.8 | 14     | 850    | 8335 10 |

|         | (mm)                    | L (mm) | F (kg) | F (N)   |
|---------|-------------------------|--------|--------|---------|
| YT-3618 | 2.4; 3.2; 4.0; 4.8; 6.4 | 16     | 1389   | 13620 6 |

## Fastening tools Narzędzia do łączenia

GB Staple gun  
D Tacker  
PL Zszywacz tapicerski  
RUS Стенпеп  
CZ Čalounická sešivačka  
H Kárpitos tűzőgép  
RO Capsator tapiterie  
E Grapadora de tapicero

DOUBLE  
BLISTER



YT-7000

12/24



YT-7001

12/24



YT-7003

6/24



YT-7007

12/24

GB Staple gun  
D Tacker  
PL Zszywacz tapicerski  
RUS Стенпеп  
CZ Čalounická sešivačka  
H Kárpitos tűzőgép

RO Capsator tapiterie  
E Grapadora de tapicero

NORMAL-MAX IMPACT FUNCTION



DOUBLE  
BLISTER



staples size / rozmiar zszywek (mm)

|         |                   |      |
|---------|-------------------|------|
| YT-7005 | 10.6x6.0-16.0x1.2 | 6/24 |
| YT-7006 | 11.3x6.0-16.0x0.7 | 6/24 |

GB Hammer tacker  
D Hammer-Tacker  
PL Zszywacz młotkowy

RUS Crennep  
CZ Čalounická sešivačka  
H Kárpitos tűzőgép

RO Capsator tapiterie  
E Grapadora de martillo



DOUBLE  
BLISTER



YT-7004

10/20

GB Staple remover  
D Klammern abwender  
PL Rozszywacz  
RUS Скобуудалитель  
CZ Rozešivač  
H Kapocskiszedő  
RO Extractor capse  
E Quitagrapas



SLIDING  
CARD



YT-7011

25/100

GB Staples  
D Heftklammern  
PL Zszywki  
RUS Скобы

CZ Sešivky  
H Tűzőkapocs  
RO Capse tapiterie  
E Grapas

HANGING  
COLOR  
BOX



for / dla: YT-7000, YT-7001,  
YT-7003, YT-7004, YT-7005

|         | L (mm) |      |        |
|---------|--------|------|--------|
| YT-7022 | 6      | 1000 | 50/200 |
| YT-7023 | 8      | 1000 | 50/200 |
| YT-7024 | 10     | 1000 | 50/100 |
| YT-7025 | 12     | 1000 | 50/100 |
| YT-7026 | 14     | 1000 | 50/100 |

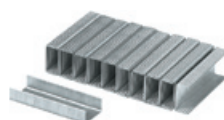

for / dla: YT-7006, YT-7007

|         | L (mm) |      |        |
|---------|--------|------|--------|
| YT-7050 | 4      | 1000 | 60/480 |
| YT-7051 | 6      | 1000 | 60/360 |
| YT-7052 | 8      | 1000 | 60/300 |
| YT-7053 | 10     | 1000 | 60/240 |
| YT-7054 | 12     | 1000 | 50/200 |
| YT-7055 | 14     | 1000 | 40/160 |

GB Nails for staple gun  
D Nageln für Yato Tacker  
PL Gwoździe do zszywacza  
RUS Гвозди для степлера  
CZ Hřebíky na sešivačku  
H Szegeka tűzőgéphez  
RO Cuie pt. capsator  
E Clavos para grapadoras

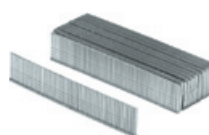

HANGING  
COLOR  
BOX



for / dla: YT-7000, YT-7001

|         | L (mm) |      |        |
|---------|--------|------|--------|
| YT-7032 | 10     | 1000 | 50/200 |
| YT-7033 | 12     | 1000 | 50/200 |
| YT-7034 | 14     | 1000 | 50/200 |

GB Pneumatic stitching machine  
 D Drucklufthefter  
 PL Zszywacz pneumatyczny  
 RUS Пневматический сшиватель  
 CZ Pneumatická sešivačka  
 H Pneumatikus tűzőgép  
 RO Capsator pneumatic  
 E Engrapadora pneumática



BMC  
& COLOR  
SLEEVE



- application: industry, construction
- przeznaczenie: przemysł, budownictwo

|         |   |
|---------|---|
| YT-0920 | 5 |
|---------|---|

GB Pneumatic nailing machine  
 D Druckluftnagelgerät  
 PL Gwoździarka pneumatyczna  
 RUS Пневматическая гвоздильная машина  
 CZ Pneumatický nastřelovač hřebíků  
 H Pneumatikus szögbelövő  
 RO Capsator pneumatic  
 E Maquina pneumática para clavar clavos



BMC  
& COLOR  
SLEEVE



\* - product not for european market  
 \* - produkt nieprzeznaczony na rynek europejski

- application: industry, construction
- przeznaczenie: przemysł, budownictwo

|          |   |
|----------|---|
| YT-0922* | 5 |
|----------|---|

GB Pneumatic nailing machine  
 D Druckluftnagelgerät  
 PL Gwoździarka pneumatyczna  
 RUS Пневматическая гвоздильная машина  
 CZ Pneumatický nastřelovač hřebíků  
 H Pneumatikus szögbelövő  
 RO Capsator pneumatic  
 E Maquina pneumática para clavar clavos



BMC  
& COLOR  
SLEEVE



- application: industry, construction
- przeznaczenie: przemysł, budownictwo

|         |   |
|---------|---|
| YT-0921 | 5 |
|---------|---|

GB Pneumatic nailing machine  
 D Druckluftnagelgerät  
 PL Gwoździarka pneumatyczna  
 RUS Пневматическая гвоздильная машина  
 CZ Pneumatický nastřelovač hřebíků  
 H Pneumatikus szögbelövő  
 RO Capsator pneumatic  
 E Maquina pneumática para clavar clavos



BMC  
& COLOR  
SLEEVE



- application: industry, construction
- przeznaczenie: przemysł, budownictwo

|         |   |
|---------|---|
| YT-0923 | 2 |
|---------|---|

## Fastening tools Narzędzia do łączenia

GB Staples  
D Heftklammern  
PL Zszywki  
RUS Сшивки  
CZ Spony  
H Tűzőkapocs  
RO Capse  
E Grapas

for / dla: YT-0920 COLOR BOX



|         | L (mm) |     |
|---------|--------|-----|
| YT-0930 | 8      | 100 |
| YT-0931 | 16     | 50  |
| YT-0932 | 25     | 50  |

GB Nails CZ Hřebíky  
D Nägel H Szeg  
PL Gwoździe RO Cuie  
RUS Гвозди E Clavos



for / dla: YT-0921

COLOR BOX



|         | L (mm) |    |
|---------|--------|----|
| YT-0941 | 50     | 20 |
| YT-0942 | 64     | 20 |



for / dla: YT-0922  
COLOR BOX



|         | L (mm) |    |
|---------|--------|----|
| YT-0938 | 38     | 20 |
| YT-0939 | 50     | 20 |
| YT-0940 | 64     | 20 |



for / dla: YT-0923, YT-0927

COLOR BOX



|         | L (mm) |    |
|---------|--------|----|
| YT-0935 | 50     | 10 |
| YT-0936 | 75     | 10 |
| YT-0937 | 90     | 10 |

GB Mini palm nailer  
D Drucklufthammer für Nägel  
PL Młotek pneumatyczny do gwoździ  
RUS Пневматический молоток  
для забивания гвоздей  
CZ Pneumatická hřebíkovačka  
H Pneumatikus szögbeütő kalapács  
RO Ciocan pneumatic pt. cuie  
E Maquina pneumática  
para clavar clavos



COLOR BOX



|         |    |
|---------|----|
| YT-0925 | 20 |
|---------|----|

GB Gas framing nailer CZ Plynová nastřelovačka hřebíků  
D Gas-nagler H Gáztechnológiás szögbeütő  
PL Gwoździarka gazowa RO Capsator cu gaz  
RUS Газовая гвоздильная машина E Clavadora de gas

GB Gas pipe  
D Gaspatrone  
PL Tuba gazowa  
RUS Баллончик с газом  
CZ Plynová bombička  
H Gáz patron  
RO Recipient cu gaz  
E Tubo de gas



fits to / pasuje do:  
YATO, PASLODE,  
HITACHI, SENCOR,  
POWERS, MAX, BEA

BMC  
& COLOR  
SLEEVE



|         |   |
|---------|---|
| YT-0927 | 2 |
|---------|---|

|         |     |
|---------|-----|
| YT-0929 | 120 |
|---------|-----|

GB Foam gun  
 D Farbspritzpistole  
 PL Pistolet do pianki montażowej  
 RUS Пистолет для нанесения полиуретановой пены

CZ Pistole na montážní pěnu  
 H Felrakó pisztoly, poliurethán habhoz  
 RO Pistol pt. spumă

E Pistola para espuma de montaje de metalo

COLOR BOX



|         |       |
|---------|-------|
| YT-6740 | 10/20 |
|---------|-------|

|         |       |
|---------|-------|
| YT-6741 | 10/20 |
|---------|-------|



|         |       |
|---------|-------|
| YT-6742 | 10/20 |
|---------|-------|

|         |    |
|---------|----|
| YT-6743 | 20 |
|---------|----|



|         |    |
|---------|----|
| YT-6744 | 20 |
|---------|----|

|         |    |
|---------|----|
| YT-6745 | 20 |
|---------|----|

12

GB Caulking gun  
 D Kartuschenpistole  
 PL Wyciskacz do mas

RUS Пистолет для герметика  
 CZ Protlačovač na hmoty  
 H Masszakinyomó

RO Pistol silicon  
 E Pistola para masilla



|         |        |       |
|---------|--------|-------|
|         | L (mm) |       |
| YT-6751 | 225    | 10/20 |

|         |        |       |
|---------|--------|-------|
|         | L (mm) |       |
| YT-6752 | 225    | 10/20 |



|         |        |      |
|---------|--------|------|
|         | L (mm) |      |
| YT-6753 | 225    | 6/12 |

|         |        |       |
|---------|--------|-------|
|         | L (mm) |       |
| YT-6754 | 225    | 10/20 |



# Fastening tools Narzędzia do łączenia

- GB Caulking gun  
D Kartuschenpistole  
PL Wyciskacz do mas
- RUS Пистолет для герметика  
CZ Protlačovač na hmoty  
H Masszakinyomó
- RO Pistol silicon  
E Pistola para masilla



|         | L (mm) |       |
|---------|--------|-------|
| YT-6750 | 225    | 20/40 |

|         | L (mm) |       |
|---------|--------|-------|
| YT-6755 | 225    | 10/20 |



|         | L (mm) |      |
|---------|--------|------|
| YT-6756 | 215    | 6/12 |

|         | L (mm) |       |
|---------|--------|-------|
| YT-6757 | 200    | 10/20 |

- GB Butane torch  
D Gasbrenner  
PL Palnik gazowy  
RUS Газовая горелка  
CZ Plynový hořák  
H Gázégő  
RO Arzător de gaz  
E Soplete de gas



HANGING  
COLOR BOX



|         |      |
|---------|------|
| YT-6700 | 6/24 |
|---------|------|

- GB Butane soldering tool  
D Gaslötkolben  
PL Lutownica gazowa  
RUS Паяльник газовый  
CZ Plynová pájka
- H Forrasztópisztoly ceruza  
bután gáz üzemű  
RO Surubelnita sudura cu gaz  
E Microsoldador de butano portátil

SLIDING  
CARD



|         |       |
|---------|-------|
| YT-6705 | 12/72 |
|---------|-------|



|         |       |
|---------|-------|
| YT-6706 | 12/48 |
|---------|-------|

GB Soldering iron  
D LötKolben  
PL Lutownica oporowa

RUS Электропаяльник  
CZ Pájka odporová  
H Forrasztópáka

RO Ciocan de lipit  
E Soldador de resistencia

HANGING  
DISPLAY  
COLOR BOX



|         | W  | working temp. of soldering tip (°C) | dimensions of soldering tip (mm) |    |
|---------|----|-------------------------------------|----------------------------------|----|
| YT-8271 | 30 | 400                                 | ø3.8 x 70                        | 16 |
| YT-8272 | 60 | 500                                 | ø6.0 x 78                        | 16 |
| YT-8273 | 80 | 520                                 | ø6.8 x 64                        | 16 |

GB Soldering iron  
D LötKolben  
PL Lutownica oporowa

RUS Электропаяльник  
CZ Pájka odporová  
H Forrasztópáka

RO Ciocan de lipit  
E Soldador de resistencia

SLIDING  
CARD



|          | W  | working temp. of soldering tip (°C) | dimensions of soldering tip (mm) |      |
|----------|----|-------------------------------------|----------------------------------|------|
| YT-8250* | 30 | 300                                 | R0.3 x ø3.8 x 70.8               | 6/60 |
| YT-8251* | 40 | 320                                 | R0.5 x ø4.9 x 75.5               | 6/60 |
| YT-8252* | 50 | 340                                 | R0.5 x ø5.9 x 76.5               | 6/60 |
| YT-8253* | 60 | 350                                 | R0.5 x ø5.9 x 76.5               | 6/60 |

\* - product not for european market  
\* - produkt nieprzeznaczony na rynek europejski



|          | W  | working temp. of soldering tip (°C) | dimensions of soldering tip (mm) |      |
|----------|----|-------------------------------------|----------------------------------|------|
| YT-8254* | 15 | 300                                 | R0.3 x ø6.4 x 42.7               | 6/60 |
| YT-8255* | 25 | 320                                 | R0.3 x ø6.4 x 42.7               | 6/60 |
| YT-8256* | 35 | 350                                 | R0.5 x ø8.0 x 57.0               | 6/60 |

GB Heater core  
D Heizeinsatz  
PL Wkład grzejny  
RUS Обогревательный вкладыш

CZ Topná vložka  
H Fűtőbetét  
RO Cartuş de încălzit  
E Elemento de calentamiento

POLYBAG  
& COLOR  
LABEL



|          | W  | working temp. of soldering tip (°C) | dimensions of soldering tip (mm) |         | for / dla |  |
|----------|----|-------------------------------------|----------------------------------|---------|-----------|--|
| YT-8257* | 30 | 400                                 | ø3.8 x 70.8                      | YT-8250 | 20/200    |  |
| YT-8258* | 40 | 420                                 | ø4.9 x 75.5                      | YT-8251 | 20/200    |  |
| YT-8259* | 50 | 440                                 | ø5.9 x 76.5                      | YT-8252 | 20/200    |  |
| YT-8260* | 60 | 450                                 | ø5.9 x 76.5                      | YT-8253 | 20/200    |  |

\* - product not for european market  
\* - produkt nieprzeznaczony na rynek europejski



|          | W  | working temp. of soldering tip (°C) | dimensions of soldering tip (mm) |         | for / dla |  |
|----------|----|-------------------------------------|----------------------------------|---------|-----------|--|
| YT-8261* | 15 | 400                                 | ø6.4 x 42.7                      | YT-8254 | 20/200    |  |
| YT-8262* | 25 | 420                                 | ø6.4 x 42.7                      | YT-8255 | 20/200    |  |
| YT-8263* | 35 | 450                                 | ø8.0 x 57.0                      | YT-8256 | 20/200    |  |

\* - product not for european market  
\* - produkt nieprzeznaczony na rynek europejski

GB Soldering tip  
D Lötspitze  
PL Grot do lutownicy

RUS Наконечник паяльника  
CZ Hrot do letovačky  
H Pákahegy

RO Vârf pt. ciocanul de lipit  
E Pico soldador

POLYBAG  
& COLOR  
LABEL



|          | W  | working temp. of soldering tip (°C) | dimensions of soldering tip (mm) |         | for / dla |  |
|----------|----|-------------------------------------|----------------------------------|---------|-----------|--|
| YT-8264* | 30 | 400                                 | R0.3 x ø3.8 x 70.8               | YT-8250 | 10/100    |  |
| YT-8265* | 40 | 420                                 | R0.5 x ø4.9 x 75.5               | YT-8251 | 10/100    |  |
| YT-8266* | 50 | 440                                 | R0.5 x ø5.9 x 76.5               | YT-8252 | 10/100    |  |
| YT-8267* | 60 | 450                                 | R0.5 x ø5.9 x 76.5               | YT-8253 | 10/100    |  |

\* - product not for european market  
\* - produkt nieprzeznaczony na rynek europejski



|          | W  | working temp. of soldering tip (°C) | dimensions of soldering tip (mm) |         | for / dla |  |
|----------|----|-------------------------------------|----------------------------------|---------|-----------|--|
| YT-8268* | 15 | 400                                 | R0.3 x ø6.4 x 42.7               | YT-8254 | 20/200    |  |
| YT-8269* | 25 | 420                                 | R0.3 x ø6.4 x 42.7               | YT-8255 | 20/200    |  |
| YT-8270* | 35 | 450                                 | R0.5 x ø8.0 x 57.0               | YT-8256 | 20/200    |  |

\* - product not for european market  
\* - produkt nieprzeznaczony na rynek europejski

GB Desoldering pump  
D Entlötsaugpumpe  
PL Odsysacz do cyny  
RUS Шприц для удаления припоя

CZ Odpájecí sací pumpa  
H Ónszipantó  
RO Pompa fluidor  
E Bomba desoldadora

SLIDING  
CARD



|          |         |
|----------|---------|
| YT-82742 | 100/400 |
|----------|---------|



|          |         |
|----------|---------|
| YT-82743 | 100/200 |
|----------|---------|



|          |        |
|----------|--------|
| YT-82744 | 50/100 |
|----------|--------|

GB Transformer soldering gun  
D Lötpistole  
PL Lutownica transformatorowa  
RUS Паяльник электрический  
CZ Transformátorová páječka

H Forrasztópáka  
RO Aparat de lipit letcon cu transformator  
E Soldador transformador



BMC  
& COLOR  
SLEEVE



|         | W   |    |
|---------|-----|----|
| YT-8245 | 180 | 10 |

## Fastening tools Narzędzia do łączenia

- GB Electric glue gun  
D Heissklebepistole  
PL Pistolet do klejenia  
RUS Пистолет для клея  
CZ Pistole na lepení  
H Ragasztópisztoly  
RO Pistol pt. lipit  
E Pistola de cola



COLOR  
BOX

|          | W        |       |
|----------|----------|-------|
| YT-82401 | 35 (400) | 12/24 |

- GB Electric glue gun  
D Heissklebepistole  
PL Pistolet do klejenia  
RUS Пистолет для клея  
CZ Pistole na lepení  
H Ragasztópisztoly  
RO Pistol pt. lipit  
E Pistola de cola



DOUBLE  
BLISTER

|          | W  |       |
|----------|----|-------|
| YT-8240* | 40 | 12/48 |
| YT-8241* | 60 | 12/48 |

- \* - product not for european market  
\* - produkt nieprzeznaczony na rynek europejski

- GB Cordless glue gun  
D Heissklebepistole  
PL Akumulatorowy  
pistolet do klejenia  
RUS Пистолет для клея  
CZ Pistole na lepení  
H Ragasztópisztoly  
RO Pistol pt. lipit  
E Pistola de cola



DOUBLE  
BLISTER

|          | W |      |
|----------|---|------|
| YT-82421 | 8 | 6/24 |

# 13

## Construction tools Narzędzia budowlane



Floor laminate cutters  
Gilotyny do cięcia paneli podłogowych

230 

Knives  
Noże

240 

Tile cutting machines & accessories  
Przyrządy do cięcia glazury i akcesoria

230-232 

Electric hoists  
Elektryczne wciągarki linowe

240 

Profile gauges  
Wzorniki profili

233 

Extension cords  
Przedłużacze elektryczne

241 

Scrapers  
Szpachelki

233 

Mixers  
Mieszadła

242 

Masonry tools  
Narzędzia tynkarskie i murarskie

234-236 

Pencils  
Ołówki

242 

Floats  
Pace..... 234  
Trowels  
Kielnie..... 236  
Plaster scrubbers  
Żdzieraki do tynków..... 236

Carpenter's pencils  
Ołówki stolarskie..... 242  
Masonry pencils  
Ołówki murarskie..... 242

Roofwork tools  
Narzędzia dekarские

237-239 

Floating rules  
Łaty

239 

- GB Floor laminate cutter  
 D Laminat-Schneider  
 PL Gilotyńa do cięcia paneli podłogowych  
 RUS Гильотина для ламината
- CZ Nůžky na laminátové plovoucí podlahy  
 H Laminát padló vágógép  
 RO Aparat de taiat parchet laminat  
 E Guillotina cortapaneles



COLOR BOX

|         |   |
|---------|---|
| YT-3730 | 4 |
|---------|---|

13

- GB Tile cutting machine  
 D Fliesenschneidmaschine  
 PL Przystaw do cięcia glazury  
 RUS Плиткопес
- CZ Přístroj na řezání glazury  
 H Csempevágó  
 RO Instrument de tăiere a glazurei  
 E Cortadora de gres



COLOR BOX



|         | L (mm) |   |
|---------|--------|---|
| YT-3700 | 400    | 2 |
| YT-3701 | 600    | 2 |
| YT-3702 | 700    | 2 |

GB Tile cutting machine  
D Fliesenschnidmaschine  
PL Przyrząd do cięcia glazury  
RUS Плиткорез

CZ Přístroj na řezání glazury  
H Csempévágó  
RO Instrument de tăiere a glazurei  
E Cortadora de gres



COLOR BOX



|         | L (mm) |   |
|---------|--------|---|
| YT-3703 | 630    | 2 |

GB Tile cutting wheel  
D Schneiderrad  
PL Kółko tnące wymienne  
RUS Ролик для плиткореза

CZ Výměnné kolečko  
H Csempévágó csavarral  
RO Cuțit rolă  
E Recambio de cuchillo redondo

SLIDING CARD



for / dla: YT-3700, YT-3701, YT-3702



for / dla: YT-3703

|         |        |
|---------|--------|
| YT-3712 | 50/250 |
|---------|--------|

|         |        |
|---------|--------|
| YT-3713 | 50/200 |
|---------|--------|

GB Tile cutting machine  
D Fliesenschnidmaschine  
PL Przyrząd do cięcia glazury  
RUS Плиткорез  
CZ Přístroj na řezání glazury

H Csempevágó  
RO Instrument de tăiere a glazurei  
E Cortadora de gres



COLOR BOX



|         | L (mm) |   |
|---------|--------|---|
| YT-3704 | 600    | 1 |
| YT-3705 | 900    | 1 |

GB Tile cutting machine  
D Fliesenschnidmaschine  
PL Przyrząd do cięcia glazury  
RUS Плиткорез

CZ Přístroj na řezání glazury  
H Csempévágó  
RO Instrument de tăiere a glazurei  
E Cortadora de gres



COLOR BOX



|         | L (mm) |   |
|---------|--------|---|
| YT-3706 | 500    | 2 |
| YT-3707 | 600    | 2 |
| YT-3708 | 800    | 2 |

GB Tile cutting wheel  
D Schneiderrad  
PL Kółko tnące wymienne  
RUS Ролик для плиткореза  
CZ Výměnné kolečko  
H Csempévágó csavarral  
RO Cuțit rolă  
E Recambio de cuchillo redondo



SLIDING CARD



for / dla: YT-3704, YT-3705, YT-3706, YT-3707, YT-3708

|         |        |
|---------|--------|
| YT-3714 | 50/200 |
|---------|--------|

GB Tile cutting pliers  
D Glasurzange  
PL Szczypce do cięcia i łamania glazury  
RUS Кусачки для плитки

CZ Kleště do glazury  
H Csempefogó  
RO Cleste rupt faianta  
E Tenazas para azulejos



SLIDING CARD



|          | L (mm) |      |
|----------|--------|------|
| YT-37160 | 200    | 6/36 |

GB Tile cutting pliers  
D Glasurzange  
PL Szczypce do glazury  
RUS Кусачки для плитки  
CZ Kleště do glazury

H Csempefogó  
RO Cleste rupt faianta  
E Tenazas para azulejos



SLIDING CARD

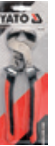

|          | L (mm) |      |
|----------|--------|------|
| YT-37163 | 215    | 6/36 |

GB Tile cutting pliers  
D Glasurzange  
PL Szczypce do łamania glazury  
RUS Кусачки для плитки  
CZ Kleště do glazury

H Csempefogó  
RO Cleste rupt faianta  
E Tenazas para azulejos



SLIDING CARD



|          | L (mm) |      |
|----------|--------|------|
| YT-37161 | 200    | 6/36 |

GB Tile cutting pliers  
D Glasurzange  
PL Szczypce do glazury  
RUS Кусачки для плитки  
CZ Kleště do glazury

H Csempefogó  
RO Cleste rupt faianta  
E Tenazas para azulejos



SLIDING CARD



|          | L (mm) |      |
|----------|--------|------|
| YT-37164 | 200    | 6/60 |

GB Tile cutting pliers  
D Glasurzange  
PL Szczypce do glazury  
RUS Кусачки для плитки  
CZ Kleště do glazury

H Csempefogó  
RO Cleste rupt faianta  
E Tenazas para azulejos

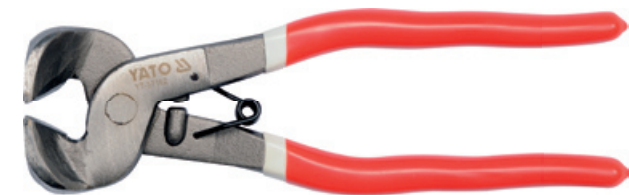

SLIDING CARD



|          | L (mm) |      |
|----------|--------|------|
| YT-37162 | 215    | 6/36 |

GB Grout remover  
D Fugenreiniger  
PL Skrobak do fug  
RUS Скребок для швов кладки

CZ Škrabák na spáry  
H Fugakihúzó  
RO Răzuitoare pt. rosturi  
E Rascador para juntas



SLIDING CARD



|          | L (mm) |       |
|----------|--------|-------|
| YT-37170 |        | 10/60 |



## Construction tools Narzędzia budowlane

GB Profile gauge      *RUS* Шаблон профилей      *RO* Șablon profile  
*D* Profilmuster      *CZ* Profilová šablona      *E* Plantilla de perfiles  
*PL* Wzornik profili      *H* Profilsablon

SLIDING  
CARD



|         | L (mm) |       |
|---------|--------|-------|
| YT-3735 | 125    | 24/72 |

|         | L (mm) |       |
|---------|--------|-------|
| YT-3736 | 260    | 10/40 |

GB Scraper      *PL* Szpachelka      *CZ* Špachtle      *RO* Șpaclu  
*D* Spachtel      *RUS* Шпатель      *H* Spatula      *E* Espátula



|         | W (mm) |        |
|---------|--------|--------|
| YT-5250 | 30     | 12/240 |
| YT-5251 | 40     | 12/240 |
| YT-5252 | 50     | 12/240 |
| YT-5253 | 60     | 12/240 |
| YT-5254 | 80     | 12/240 |
| YT-5255 | 100    | 12/240 |

GB Trowel for silicone      *RUS* Шпатель для силикона      *RO* Spatulă pt. silicon  
*D* Spachtel für Silikon      *CZ* Špachtle na silikon      *E* Espátula para silicona  
*PL* Szpachelka do silikonu      *H* Spachli szilikonhoz



HANGING  
CARD



|         |        |
|---------|--------|
| YT-5260 | 20/300 |
|---------|--------|



SLIDING  
CARD



|         |        |
|---------|--------|
| YT-5261 | 20/200 |
|---------|--------|



SLIDING  
CARD



|         |        |
|---------|--------|
| YT-5262 | 20/200 |
|---------|--------|

GB Smooth float  
D Schweizer Glättkelle  
PL Paca gładka  
RUS Тёрка гладкая  
CZ Hladitko rovné

H Glettväs rozsdamentes  
RO Gletiera  
E Llana para enlucido



• made of special cold rolled stainless steel sheet with elasticity factor up to 2000 N/mm  
• części robocze ze specjalnej zimnowalcowanej blachy nierdzewnej o sprężystości do 2000 N/mm

| mm      |         |    |
|---------|---------|----|
| YT-5200 | 270x130 | 30 |

GB Float with teeth  
D Zahnkelle  
PL Paca zębata  
RUS Тёрка с зубами  
CZ Hladitko zuby

H Glettväs fogazott  
RO Gletiera zimtata  
E Llana dentada



• made of special cold rolled stainless steel sheet with elasticity factor up to 2000 N/mm  
• części robocze ze specjalnej zimnowalcowanej blachy nierdzewnej o sprężystości do 2000 N/mm

| teeth / zęby |       | mm      |    |
|--------------|-------|---------|----|
| YT-5202      | 6x6   | 275x130 | 30 |
| YT-5203      | 8x8   | 270x130 | 30 |
| YT-5204      | 10x10 | 260x130 | 30 |

GB Smooth float  
D Schweizer Glättkelle  
PL Paca tynkarska  
RUS Тёрка гладкая  
CZ Hladitko rovné  
H Glettväs rozsdamentes  
RO Gletiera  
E Llana para enlucido



• made of special cold rolled stainless steel sheet with elasticity factor up to 2000 N/mm  
• części robocze ze specjalnej zimnowalcowanej blachy nierdzewnej o sprężystości do 2000 N/mm

| mm      |         |    |
|---------|---------|----|
| YT-5207 | 380x130 | 40 |
| YT-5209 | 480x130 | 10 |
| YT-5210 | 580x130 | 10 |

GB Sharp ground float  
D Steinholzglätter  
PL Paca ostra  
RUS Стальная острая тёрка  
CZ Hladitko ocelové, špičaté  
H Aljzatsimitó  
RO Gletiera cu varf ascutit  
E Llana pontiaguda

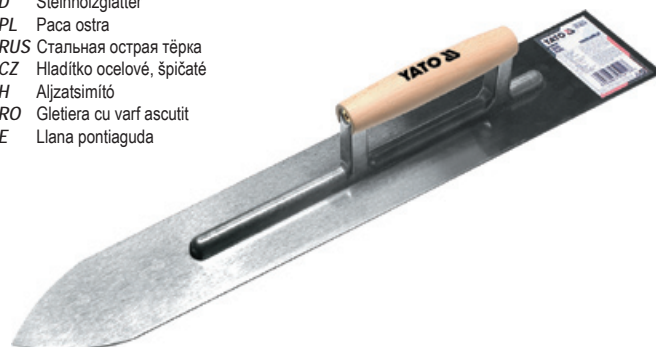

| mm      |     |    |
|---------|-----|----|
| YT-5212 | 500 | 20 |

GB Smooth float  
D Glättkelle  
PL Paca wenecka  
RUS Тёрка венецианская  
CZ Hladitko rovné  
H Glettväs rozsdamentes  
lágú fogantyúval  
RO Gletiera  
E Llana puntas redondas



• made of special cold rolled stainless steel sheet with elasticity factor up to 2000 N/mm  
• części robocze ze specjalnej zimnowalcowanej blachy nierdzewnej o sprężystości do 2000 N/mm

| mm      |        |    |
|---------|--------|----|
| YT-5214 | 200x80 | 20 |

GB Smooth float  
D Glättkelle  
PL Paca wenecka  
RUS Тёрка венецианская  
CZ Hladitko rovné  
H Glettväs rozsdamentes  
lágú fogantyúval  
RO Gletiera  
E Llana puntas redondas



• made of special cold rolled stainless steel sheet with elasticity factor up to 2000 N/mm  
• części robocze ze specjalnej zimnowalcowanej blachy nierdzewnej o sprężystości do 2000 N/mm

| mm      |           |    |
|---------|-----------|----|
| YT-5216 | 75x95x240 | 20 |

GB Abrasive float "Rasp" type  
D Styropor-Schleifbrett  
PL Paca ścierna do styropianu  
RUS Шлифовальная тёрка "рашпиль"  
CZ Škrábák na porobeton  
H Csiszoló polystirol habhoz  
RO Gletiera abraziva  
E Llana abrasiva para polietileno



| mm      |         |    |
|---------|---------|----|
| YT-5218 | 165x370 | 20 |

GB Stripping knife  
D Flächenspachtel  
PL Szpachla fasadowa  
RUS Стальной шпатель  
CZ Štěrka fasádní  
H Spatulya fali (rákli)  
RO Spaclu inox  
E Espátula de fachada



• made of special cold rolled stainless steel sheet with elasticity factor up to 2000 N/mm  
• części robocze ze specjalnej zimnowalcowanej blachy nierdzewnej o sprężystości do 2000 N/mm

| mm      |     |    |
|---------|-----|----|
| YT-5226 | 250 | 20 |
| YT-5228 | 350 | 20 |
| YT-5230 | 500 | 20 |

- GB Articulated float with hydrorubber  
D Deckenreibebrett Alu mit Schwammgummi  
PL Paca przegubowa z hydrogumą  
RUS Треугольный мастерок для каменщиков  
CZ Hladítko ALU kloubové s hydrogumou  
H Simitó szivacsos durva nyelezhető  
RO Gletiera cu burete cauciucat si maner multifunctional  
E Llana para el acabado, articulada, de aluminio, con goma-espuma



- large surface area and porous specialist hydro-rubber and practical articulated joint for setting on handle enables rapid floating without the necessity to use a ladder
- dzięki dużej powierzchni, porowatej specjalistycznej hydrogumie oraz praktycznemu przegubowi do osadzenia na trzonku pozwala na szybkie zacieranie bez potrzeby używania drabiny

|         | mm      |    |
|---------|---------|----|
| YT-5221 | 195x395 | 10 |

- GB Aluminium float with hydrorubber  
D Alu-schwammbrett mit hydrogummi  
PL Paca aluminiowa z hydrogumą  
RUS Терка алюминиевая с накладкой из губчатой резины  
CZ Hladítko aluminiové s hydrogumou  
H Fugázó alumíniumtestű hidroszivaccsal  
RO Gletiera de aluminiu cu hidrocauciuc  
E Talocha aluminio con hidrogoma

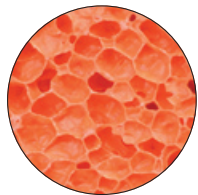
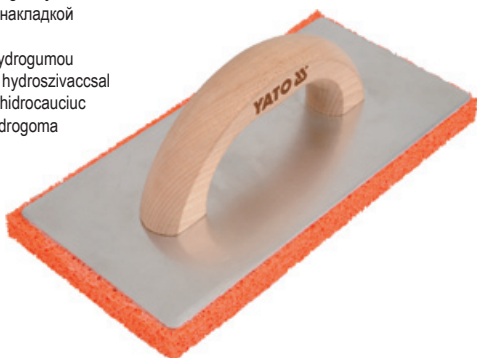

|         | mm      |    |
|---------|---------|----|
| YT-5302 | 130x270 | 12 |

- GB Aluminium float with sponge  
D Alu-schwammbrett mit schwamm  
PL Paca aluminiowa z gąbką  
RUS Терка алюминиевая с накладкой из поролона  
CZ Hladítko aluminiové s hydrohoubou  
H Fugázó alumíniumtestű szivaccsal  
RO Gletiera de aluminiu cu burete  
E Talocha aluminio con esponja

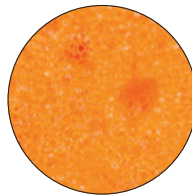
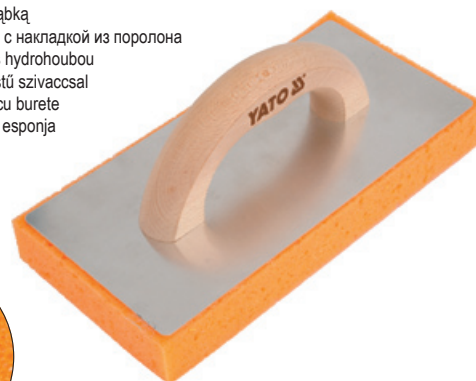

|         | mm      |    |
|---------|---------|----|
| YT-5304 | 130x270 | 12 |

- GB Aluminium float with incised sponge  
D Alu-schwammbrett mit schwamm geschnitten  
PL Paca aluminiowa z gąbką nacinaną  
RUS Терка алюминиевая с накладкой из поролона надрезанная  
CZ Hladítko aluminiové s hydrohoubou dělenou  
H Fugázó alumíniumtestű irdalt szivaccsal  
RO Gletiera de aluminiu burete cu striatii  
E Talocha aluminio con esponja de incisiones

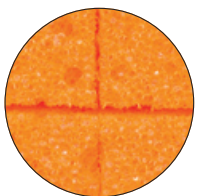
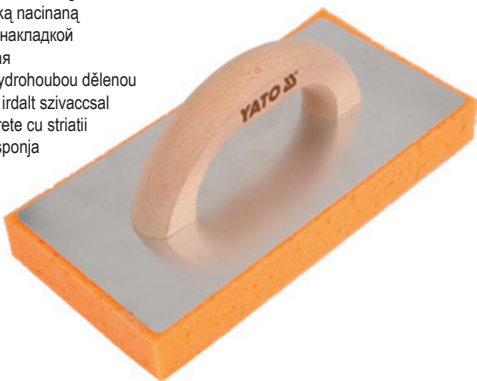

|         | mm      |    |
|---------|---------|----|
| YT-5305 | 130x270 | 12 |

- GB Aluminium float with porous sponge  
D Alu-schwammbrett mit rauem schwamm  
PL Paca aluminiowa z gąbką porowatą  
RUS Терка алюминиевая с накладкой из микропористой резины  
CZ Hladítko aluminiové s hrubou houbou  
H Fugázó alumíniumtestű durva szivaccsal  
RO Gletiera de aluminiu cu burete poros  
E Talocha aluminio con esponja de poros

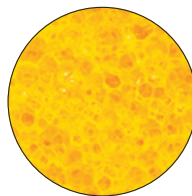
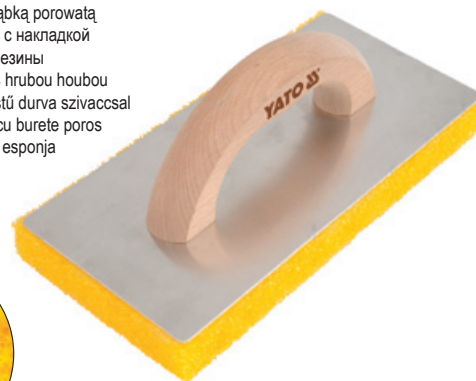

|         | mm      |    |
|---------|---------|----|
| YT-5306 | 130x270 | 12 |

- GB Aluminium float with felt  
D Alu-filzbrett  
PL Paca aluminiowa z filcem  
RUS Терка алюминиевая с накладкой из войлока  
CZ Hladítko aluminiové s bílým filcem  
H Fugázó alumíniumtestű filces  
RO Gletiera de aluminiu cu pasla  
E Talocha aluminio con fieltro

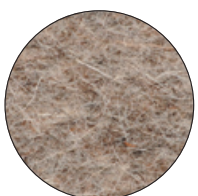
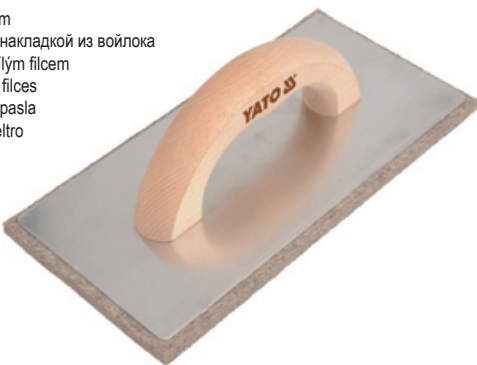

|         | mm      |    |
|---------|---------|----|
| YT-5307 | 130x270 | 12 |

- GB Aluminium float with soft rubber  
D Alu-gummbrett mit weichem gummi  
PL Paca aluminiowa z miękką gumą  
RUS Терка алюминиевая с накладкой из мягкой губчатой резины  
CZ Hladítko aluminiové s měkkou gumou  
H Fugázó alumíniumtestű lágy gumiszivaccsal  
RO Gletiera de aluminiu cu cauciuc moale  
E Talocha aluminio con goma blanda

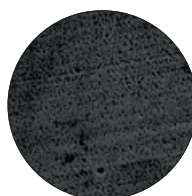

|         | mm     |    |
|---------|--------|----|
| YT-5310 | 90x210 | 12 |

GB Triangular trowel  
D Maurerkelle  
PL Kielnia trójkątna  
RUS Треугольный мастерок  
CZ Lžíce trojúhelníková  
H Kőműves kanál háromszögletű  
RO Mistrîe triunghi  
E Paleta triangular



- made of special cold rolled stainless steel sheet with elasticity factor up to 2000 N/mm
- części robocze ze specjalnej zimnowalcowanej blachy nierdzewnej o sprężystości do 2000 N/mm

| mm      |         |    |
|---------|---------|----|
| YT-5234 | 200x190 | 10 |

GB Trapezoid trowel  
D Stukkateurkelle  
PL Kielnia trapezowa  
RUS Трапецидальный мастерок  
CZ Lžíce zednická  
H Kőműves kanál rozsdamentes  
RO Mistrîe  
E Paleta trapezoidal



- made of special cold rolled stainless steel sheet with elasticity factor up to 2000 N/mm
- części robocze ze specjalnej zimnowalcowanej blachy nierdzewnej o sprężystości do 2000 N/mm

| mm      |            |    |
|---------|------------|----|
| YT-5237 | 120x180x80 | 10 |

GB Trapezoid trowel  
D Stukkateurkelle  
PL Kielnia trapezowa  
RUS Трапецидальный мастерок  
CZ Lžíce zednická  
H Kőműves kanál rozsdamentes  
RO Mistrîe  
E Paleta trapezoidal



- made of special cold rolled stainless steel sheet with elasticity factor up to 2000 N/mm
- części robocze ze specjalnej zimnowalcowanej blachy nierdzewnej o sprężystości do 2000 N/mm

| mm      |           |    |
|---------|-----------|----|
| YT-5240 | 165x80x55 | 20 |

GB Stucco trowel  
D Gipserspachtel  
PL Kielnia „Podkowa”  
RUS Штукатурный мастерок  
CZ Lžíce vymazávací  
H Gittelő kanál rozsdamentes  
RO Mistrîe  
E Paleta para estucado



- made of special cold rolled stainless steel sheet with elasticity factor up to 2000 N/mm
- części robocze ze specjalnej zimnowalcowanej blachy nierdzewnej o sprężystości do 2000 N/mm

| mm      |         |    |
|---------|---------|----|
| YT-5242 | 100x130 | 20 |
| YT-5243 | 80x110  | 20 |

GB Stucco sharp trowel  
D Putzkelle  
PL Kielnia ostra  
RUS Кельма заостренная треугольная  
CZ Lžíce pokrývačská  
H Gittelő kanál rozsdamentes  
RO Mistrîe cu cioc ascuțit  
E Paleta pontiaguda

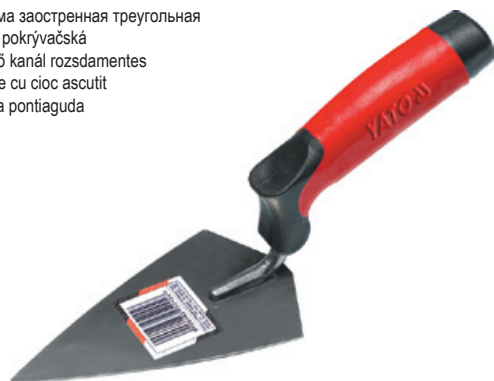

- made of special cold rolled stainless steel sheet with elasticity factor up to 2000 N/mm
- części robocze ze specjalnej zimnowalcowanej blachy nierdzewnej o sprężystości do 2000 N/mm

| mm      |        |    |
|---------|--------|----|
| YT-5245 | 135x80 | 20 |

GB Plaster scrubber  
D Alu-Rabott  
PL Żdzierak do tynków  
RUS Треугольный мастерок для каменщиков  
CZ Škrabák  
H Vakolat gyalu alu késes  
RO Gletiera abraziva  
E Rascador para enlucido



| mm      |        |    |
|---------|--------|----|
| YT-5247 | 450x90 | 25 |

GB Tin snips  
D Blechscherer  
PL Nożyce do cięcia blachy  
RUS Ножницы по металлу

CZ Nůžky na plech  
H Lemezvágó olló  
RO Foarfece pt. tablă  
E Tijeras para chapas

SLIDING  
CARD



|         | L (mm) | cutting length (mm) | cutting capacities (mm) |                   |                  |                     |      |
|---------|--------|---------------------|-------------------------|-------------------|------------------|---------------------|------|
|         |        |                     | copper                  | cold-rolled steel | hard steel HRC35 | stainless steel 304 |      |
| YT-1900 | 260    | 30                  | 0.94                    | 0.78              | 0.60             | 0.45                | 6/24 |



|         | L (mm) | cutting length (mm) | cutting capacities (mm) |                   |                  |                     |      |
|---------|--------|---------------------|-------------------------|-------------------|------------------|---------------------|------|
|         |        |                     | copper                  | cold-rolled steel | hard steel HRC35 | stainless steel 304 |      |
| YT-1901 | 260    | 30                  | 0.94                    | 0.78              | 0.60             | 0.45                | 6/24 |



|         | L (mm) | cutting length (mm) | cutting capacities (mm) |                   |                  |                     |      |
|---------|--------|---------------------|-------------------------|-------------------|------------------|---------------------|------|
|         |        |                     | copper                  | cold-rolled steel | hard steel HRC35 | stainless steel 304 |      |
| YT-1902 | 300    | 50                  | 0.94                    | 0.78              | 0.60             | 0.45                | 6/24 |



|         | L (mm) | cutting length (mm) | cutting capacities (mm) |                   |                  |                     |      |
|---------|--------|---------------------|-------------------------|-------------------|------------------|---------------------|------|
|         |        |                     | copper                  | cold-rolled steel | hard steel HRC35 | stainless steel 304 |      |
| YT-1925 | 225    | 52                  | 0.94                    | 0.78              | 0.60             | 0.45                | 6/36 |

GB Tin snips  
D Blechscherer  
PL Nożyce do cięcia blachy  
RUS Ножницы по металлу

CZ Nůžky na plech  
H Lemezvágó olló  
RO Foarfece pt. tablă  
E Tijeras para chapas



SLIDING  
CARD



|         | L (mm) | cutting length (mm) | cutting capacities (mm) |                   |                  |                     |      |
|---------|--------|---------------------|-------------------------|-------------------|------------------|---------------------|------|
|         |        |                     | copper                  | cold-rolled steel | hard steel HRC35 | stainless steel 304 |      |
| YT-1913 | 225    | 30                  | 0.78                    | 0.53              | 0.46             | 0.36                | 6/36 |

|         | L (mm) | cutting length (mm) | cutting capacities (mm) |                   |                  |                     |      |
|---------|--------|---------------------|-------------------------|-------------------|------------------|---------------------|------|
|         |        |                     | copper                  | cold-rolled steel | hard steel HRC35 | stainless steel 304 |      |
| YT-1914 | 225    | 30                  | 0.78                    | 0.53              | 0.46             | 0.36                | 6/36 |

- GB Portable notchers  
 D Schere zum Ausschneiden von Ecken  
 PL Nożyce do wycinania naroży  
 RUS Ножницы для наружных углов  
 CZ Nůžky na vystřihování rohů  
 H Sarokkivágó olló  
 RO Foarfeca pt. taierea colturilor  
 E Tijera para esquinas



| L (mm)  |        |
|---------|--------|
| YT-1939 | 300 15 |

- GB Straight pliers  
 D Zange zum Blechbiegen  
 PL Kleszcze do gięcia blach  
 RUS Клещи с тупым ножом для жести  
 CZ Kleště na ohýbání plechu

- H Falcfogó  
 RO Cleste pt. indoirea tablei  
 E Tenazas para doblar hojalata



| L (mm)  |           |
|---------|-----------|
| YT-5416 | 280 10/20 |

| L (mm)  |           |
|---------|-----------|
| YT-5417 | 260 10/20 |

| L (mm)  |           |
|---------|-----------|
| YT-5415 | 280 10/20 |

- GB Single seam clench  
 D Klemme für Einfachfalz  
 PL Zaciskacz rąbka pojedynczego  
 RUS Зажим отдельного фальца  
 CZ Uzavírač jednoduché drážky  
 H Falclezáró fogó  
 RO Clema pt. falt simplu  
 E Pinza para costura individual

- GB Double seam clench  
 D Klemme für Doppelfalz  
 PL Zaciskacz rąbka podwójnego  
 RUS Зажим двойного фальца  
 CZ Uzavírač dvojité drážky  
 H Duplafalclezáró fogó  
 RO Clema pt. falt dublu  
 E Pinza para costura doble

- GB Eaves turner  
 D Kantvorrichtung für Dachtraufe  
 PL Kantownik okapu  
 RUS Угольник навеса  
 CZ Ohýbačka okapnice  
 H Ereszperemező fogó  
 RO Cornier streasina  
 E Volteador de alero

- GB Eaves clench  
 D Klemme für Dachtraufe  
 PL Zaciskacz okapu  
 RUS Зажим навеса  
 CZ Uzavírač okapnice  
 H Ereszáró fogó  
 RO Clema pt. streasina  
 E Pinza para alero



| (mm)         |              |
|--------------|--------------|
| pipe / rurki | mm           |
| YT-5400      | 18 480x220 5 |

| (mm)         |              |
|--------------|--------------|
| pipe / rurki | mm           |
| YT-5402      | 18 480x220 5 |

| (mm)         |              |
|--------------|--------------|
| pipe / rurki | mm           |
| YT-5404      | 18 450x200 5 |

| (mm)         |              |
|--------------|--------------|
| pipe / rurki | mm           |
| YT-5405      | 18 450x200 5 |

- GB Drainpipe hooks bender  
D Biegewerkzeug für Dachrinnenhaken  
PL Zaginacz haków rynnowych  
RUS Прибор для загибания крюков для водосточных желобов  
CZ Ohýbačka okapových háků  
H Ereszcatorna-tartóvas hajlító  
RO Dispozitiv pt. indoit cărlige burlian  
E Herramienta para doblar los ganchos para canalones

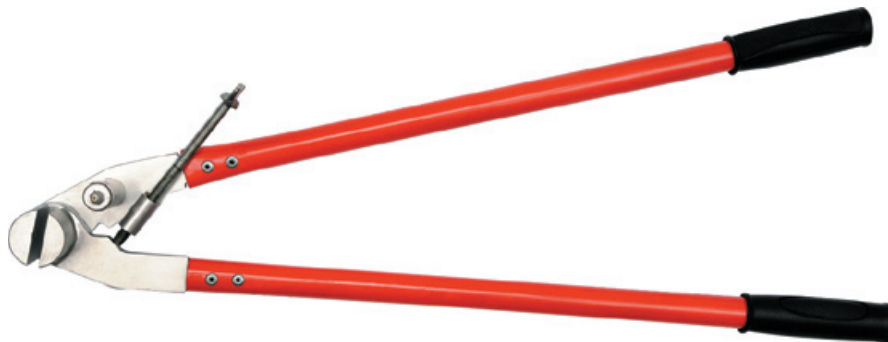

|         | L (mm) |   |
|---------|--------|---|
| YT-5410 | 680    | 5 |

- GB Patch puller  
D Vorrichtung zum Ausreißen von Latten  
PL Wyrugacz łat  
RUS Выдёргиватель планок  
CZ Třhač latění  
H Foltbontó vas  
RO Dispozitiv de smuls sipca  
E Arrancador de parches



|         | pipe / rurki (mm) | mm      |   |
|---------|-------------------|---------|---|
| YT-5406 | 25                | 700x140 | 6 |

- GB Roofing paper unreeling rod  
D Stange zum Abwickeln der Dachpappe  
PL Laska do rozwijania papy  
RUS Штeхер для развёртывания толевого картона  
CZ Tyč k odvíjení asfaltových pásů  
H Pálca kátrányapír kiterítéséhez  
RO Bara de întins membrana bituminoasa  
E Vara para desenrollar cartón asfaltado/cartón alquitranado

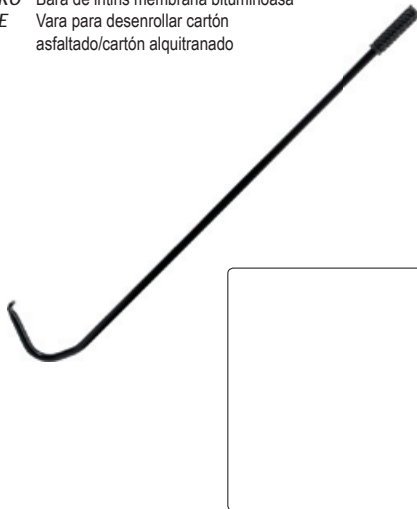

|         | pipe / rurki (mm) | mm       |    |
|---------|-------------------|----------|----|
| YT-5407 | 18                | 1100x230 | 10 |

- GB Roofing paper unreeler  
D Dachpappenabwickler  
PL Rozwijacz papy  
RUS Расправитель толевого картона  
CZ Vodičí tyč k pokládce asfaltových pásů  
H Kátrányapír kiterítő  
RO Derulator pt. membrana bituminoasa  
E Desenrollador para cartón asfaltado/cartón alquitranado

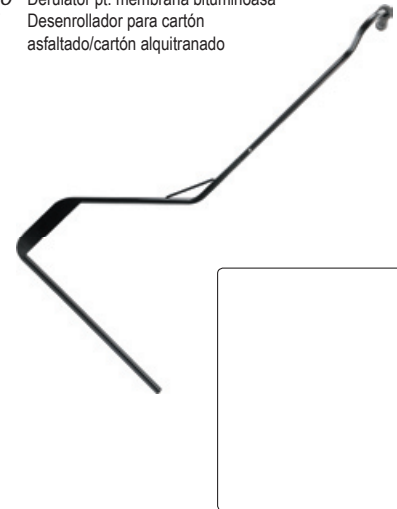

|         | pipe / rurki (mm) | mm   |   |
|---------|-------------------|------|---|
| YT-5408 | 22                | 1350 | 5 |

- GB Rectangular floating rule  
D Setzlatte 2 Libellen  
PL Łata murarska  
RUS Правило-уровень  
CZ Lat' zednická s libelami  
H Ölesléc, téglalap keresztmetszetű  
RO Dreptar cu 2 bule  
E Nivel de albañil



|         | L (mm) |    |
|---------|--------|----|
| YT-3071 | 1500   | 10 |
| YT-3072 | 2000   | 10 |
| YT-3073 | 2500   | 10 |
| YT-3074 | 3000   | 10 |



|         | L (mm) |    |
|---------|--------|----|
| YT-3076 | 1500   | 10 |
| YT-3077 | 2000   | 10 |
| YT-3078 | 2500   | 10 |
| YT-3079 | 3000   | 10 |

- GB Trapezoid floating rule  
D Abziehlatte mit Trapezprofil  
PL Łata tynkarska  
RUS Правило трапециевидное  
CZ Lat' maliřská  
H Ölesléc, trapézoid keresztmetszetű  
RO Dreptar trapezoidal  
E Nivel de albañil



|         | L (mm) |    |
|---------|--------|----|
| YT-3081 | 1500   | 10 |
| YT-3082 | 2000   | 10 |
| YT-3083 | 2500   | 10 |
| YT-3084 | 3000   | 10 |

- GB Knife for roofing paper
- D Messer zum Schneiden von Pappe
- PL Nóż do cięcia papy
- RUS Нож для резки рубероида
- CZ Nůž k řezání lepenky
- H Kátrányapírvágó olló
- RO Cutter pt. tăierea cartonului asfaltat
- E Cuchilla para cortar cartón alquitranado



SLIDING CARD

|         | L (mm) |       |
|---------|--------|-------|
| YT-7620 | 230    | 12/60 |

- GB Knife for mineral wool
- D Messer zum Schneiden von Baisolierungen
- PL Nóż do cięcia izolacji budowlanych
- RUS Нож для резки строительной изоляции
- CZ Nůž k řezání stavebních izolačních hmot
- H Kés épületszigetelés vágásához
- RO Cutter pt. tăierea izolațiilor
- E Cuchilla para cortar aislamiento de construcción

SLIDING CARD



|         | L (mm) |       |
|---------|--------|-------|
| YT-7623 | 500    | 10/50 |

|         | L (mm) |       |
|---------|--------|-------|
| YT-7624 | 480    | 10/50 |

- GB Electric hoist
- D Elektro-Seilwinde
- PL Elektryczna wciągarka linowa
- RUS Электрическая канатная лебедка
- CZ Elektrický naviják kladkostroj
- H Elektromos csőrő
- RO Troliu electric cu cablu
- E Cabria eléctrica de cuerdas



|         |   |
|---------|---|
| YT-5901 | 2 |
|---------|---|

|         |   |
|---------|---|
| YT-5902 | 2 |
|---------|---|

|         |   |
|---------|---|
| YT-5904 | 2 |
|---------|---|

|         |   |
|---------|---|
| YT-5905 | 2 |
|---------|---|

COLOR BOX





- GB Extension cord  
D Verlängerungskabel  
PL Przedłużacz elektryczny  
RUS Удлинитель электрический  
CZ Elektrický prodloužovač  
H Elektromos hosszabbító  
RO Prelungitor electric  
E Extensión electr.

COLOR  
BOX



|         | L (m) |   |
|---------|-------|---|
| YT-8100 | 20    | 4 |
| YT-8101 | 30    | 2 |
| YT-8102 | 40    | 2 |

- GB Cable reel  
D Kabeltrommel  
PL Przedłużacz zwijany  
RUS Удлинитель электрический  
CZ Bubnový prodloužovač  
H Kábeldob  
RO Prelungitor pe tambur  
E Cable de prolongación de tambor



- $P_{max} = 1300\text{ W}$  coiled  
 $P_{max} = 1300\text{ W}$  zwinęty
- $P_{max} = 3600\text{ W}$  uncoiled  
 $P_{max} = 3600\text{ W}$  rozwinęty

|         | L (m) |   |
|---------|-------|---|
| YT-8104 | 40    | 1 |

- GB Rubber protection extension cord  
D Gummiisolierte Verlängerungsschnur  
PL Przedłużacz w osłonie gumowej  
RUS Удлинитель с резиновой изоляцией  
CZ Prodloužovací kabel s gumovou izolací  
H Gumi szigetelésű hosszabbító  
RO Cablu prelunitor cauciuc  
E Cable de extensión con protección de caucho



|         | L (m) |    |
|---------|-------|----|
| YT-8110 | 2     | 40 |
| YT-8111 | 5     | 16 |
| YT-8112 | 10    | 8  |

- GB Cable reel  
D Kabeltrommel  
PL Przedłużacz zwijany  
RUS Удлинитель электрический  
CZ Bubnový prodloužovač  
H Kábeldob  
RO Prelungitor pe tambur  
E Cable de prolongación de tambor



- $P_{max} = 1200\text{ W}$  coiled  
 $P_{max} = 1200\text{ W}$  zwinęty
- $P_{max} = 3600\text{ W}$  uncoiled  
 $P_{max} = 3600\text{ W}$  rozwinęty

|         | L (m) |   |
|---------|-------|---|
| YT-8106 | 30    | 1 |
| YT-8107 | 40    | 1 |
| YT-8108 | 50    | 1 |

- GB Rubber protection extension cord  
D Gummiisolierte Verlängerungsschnur  
PL Przedłużacz w osłonie gumowej  
RUS Удлинитель с резиновой изоляцией  
CZ Prodloužovací kabel s gumovou izolací  
H Gumi szigetelésű hosszabbító  
RO Cablu prelunitor cauciuc  
E Cable de extensión con protección de caucho



|         | L (m) |    |
|---------|-------|----|
| YT-8115 | 2     | 10 |
| YT-8116 | 10    | 4  |

- GB Drum power extension cord  
D Verlängerungstrommel für Kraftstrom  
PL Przedłużacz bębnowy siłowy  
RUS Силовой удлинитель барабанного типа  
CZ Prodloužovací kabel silový na bubnu  
H Háromfázisú hosszabbító dob  
RO Derulator cu tambur  
E Cilindro de extensión de fuerza



- ~230V; 2P+E  
 $P_{max} = 1200\text{ W}$  coiled  
 $P_{max} = 1200\text{ W}$  zwinęty  
 $P_{max} = 3000\text{ W}$  uncoiled  
 $P_{max} = 3000\text{ W}$  rozwinęty
- ~400V; 3P+N+E  
 $P_{max} = 3000\text{ W}$  coiled  
 $P_{max} = 3000\text{ W}$  zwinęty  
 $P_{max} = 9000\text{ W}$  uncoiled  
 $P_{max} = 9000\text{ W}$  rozwinęty

|         | L (m) |   |
|---------|-------|---|
| YT-8120 | 25    | 1 |

GB Cup mixer  
D Korbbrührer für klumpige, zähe Materialien

PL Mieszadło koszykowe  
RUS Краскомешалка  
CZ Košíkové míchadlo

H Kosaras keverő  
RO Mixer pt. vopsea - tip pahar  
E Agitador de cesta



- application: powder materials, sealing compounds, gypsum surface finishing mixes, self-leveling mortars
- zastosowanie: materiały sypkie, masy uszczelniające, gładzie szpachlowe, zaprawy samopoziomujące

|         | (mm) | L (mm) | shank /<br>uchwyt | max. mixing capacity /<br>max. wydajność mieszania (kg) |    |
|---------|------|--------|-------------------|---|----|
| YT-5481 | 80   | 470    | HEX               | 5-10  | 25 |
| YT-5482 | 100  | 470    | HEX               | 10-20   | 20 |
| YT-5483 | 100  | 600    | SDS+              | 10-20   | 18 |

GB Spiral bar mixer  
D Rundstabrührer für klebrige, geschmeidige Materialien

PL Mieszadło spiralne prętowe  
RUS Краскомешалка  
CZ Spirálové míchadlo drátové

H Spirális, pálcás keverő  
RO Malaxor pt. vopsea  
E Agitatore pala/cinta



- application: powder materials, general-purpose adhesives, gypsum surface finishing mixes, epoxy grouts
- zastosowanie: materiały sypkie, gotowe zaprawy klejowe, masy szpachlowe, zaprawy do spoinowania

|         | (mm) | L (mm) | shank /<br>uchwyt | max. mixing capacity /<br>max. wydajność mieszania (kg) |    |
|---------|------|--------|-------------------|---|----|
| YT-5490 | 85   | 410    | HEX               | 4-9   | 30 |
| YT-5491 | 100  | 600    | HEX               | 6-16  | 16 |
| YT-5492 | 85   | 450    | SDS+              | 4-9   | 30 |
| YT-5493 | 100  | 600    | SDS+              | 6-16  | 16 |

GB Spiral mixer  
D Rondenrührer für dünnflüssige Materialien

PL Mieszadło spiralne  
RUS Краскомешалка  
CZ Spirálové míchadlo

H Spirális keverő  
RO Malaxor pt. vopsea  
E Agitador de cinta helicoidal



- application: emulsion paints, acrylic paints, lacquers, stains, other liquid materials
- zastosowanie: farby emulsyjne, farby akrylowe, lakiery, bejce, inne materiały płynne

|         | (mm) | L (mm) | shank /<br>uchwyt | max. mixing capacity /<br>max. wydajność mieszania (kg) |    |
|---------|------|--------|-------------------|---|----|
| YT-5494 | 80   | 400    | HEX               | 5-10  | 30 |
| YT-5495 | 100  | 600    | HEX               | 10-25   | 20 |
| YT-5496 | 100  | 600    | SDS+              | 15-30   | 20 |

GB Double spiral mixer  
D Wendelrührer für klebrige, zähe Materialien

PL Mieszadło spiralne podwójne  
RUS Краскомешалка  
CZ Spirálové míchadlo dvojité

H Dupla spirális keverő  
RO Malaxor spirala dubla pt. vopsea  
E Agitador de cinta helicoidal doble



- application: general-purpose adhesives, masonry mortars, jointless floors, thin-layer mineral plasters, gypsum surface finishing mixes, isolation masses
- zastosowanie: zaprawy klejowe, zaprawy murarskie, jastrych, tynki strukturalne, masy szpachlowe, masy izolacyjne

|         | (mm) | L (mm) | shank /<br>uchwyt | max. mixing capacity /<br>max. wydajność mieszania (kg) |    |
|---------|------|--------|-------------------|---|----|
| YT-5497 | 70   | 400    | HEX               | 5-10  | 20 |
| YT-5499 | 100  | 600    | HEX               | 10-20   | 16 |
| YT-5500 | 120  | 600    | HEX               | 15-25   | 14 |
| YT-5501 | 100  | 600    | SDS+              | 10-20   | 16 |
| YT-5502 | 120  | 600    | SDS+              | 15-25   | 14 |
| YT-5503 | 120  | 600    | M14               | 15-25   | 14 |
| YT-5504 | 160  | 600    | M14               | 20-30   | 8  |

GB Triple spiral mixer  
D Wendelrührer für schwere, zähe Materialien

PL Mieszadło spiralne potrójne  
RUS Краскомешалка  
CZ Spirálové míchadlo trojité

H Tripla spirális keverő  
RO Malaxor spirala tripla pt. vopsea  
E Agitador de cinta helicoidal triple



- application: mortars, concrete, plasters, other semi-fluid materials with sand or gravel filling
- zastosowanie: zaprawy, beton, tynki, inne półpłynne, lepkie materiały z wypełnieniem piaskowym lub żwirowym

|         | (mm) | L (mm) | shank /<br>uchwyt | max. mixing capacity /<br>max. wydajność mieszania (kg) |    |
|---------|------|--------|-------------------|---|----|
| YT-5505 | 100  | 600    | HEX               | 10-20   | 16 |
| YT-5506 | 120  | 600    | SDS+              | 15-25   | 12 |
| YT-5507 | 120  | 600    | M14               | 15-25   | 12 |
| YT-5508 | 160  | 600    | M14               | 20-30   | 8  |

GB Carpenter's pencil  
D Zimmermannsbleistifte  
PL Ołówek stolarski

RUS Карандаш столярный  
CZ Tesařská tužka  
H Asztalos ceruza

RO Creion de tâmplărie  
E Lapiz de carpintero



COLOR BOX



|         | L (mm) | W (mm) |     |   |
|---------|--------|--------|-----|---|
| YT-6925 | 245    | 15     | 144 | 8 |



|         | L (mm) | W (mm) |     |   |
|---------|--------|--------|-----|---|
| YT-6926 | 245    | 12     | 144 | 8 |

GB Masonry pencil  
D Maurerbleistift  
PL Ołówek murarski

RUS Карандаш каменщика  
CZ Tužka zednická  
H Kőműves keverő

RO Creion  
E Lapiz de albañil



COLOR BOX



|         | L (mm) | W (mm) |     |   |
|---------|--------|--------|-----|---|
| YT-6927 | 245    | 12     | 144 | 8 |

Memo

# 14

## Measuring tools Narzędzia miernicze



## Measuring tools Narzędzia miernicze

Electric meters  
Mierniki elektryczne

246



Try squares  
Kątowniki stolarskie

250



Multimeters  
Mierniki

247



Vernier calipers  
Suwmiarki

250



Measuring tapes  
Miary zwijane

248-249



Levels  
Poziomnice

251



Folding rules  
Miary składane

250



Feelers  
Szczelinomierze

251



Rulers  
Przymiary

250



GB Digital voltage tester  
 D Digitaler-Spannungsprüfer  
 PL Wskaźnik elektryczny  
 RUS Тестер напряжения цифровой

CZ Zkoušečka napětí digitální  
 H Digitális voltmérő  
 RO Tester digital pt. tensiune electrica  
 E Indicador eléctrico

SLIDING  
 CARD



YT-2861

20/500



YT-2862

20/500



YT-2863

6/120

GB Analogue battery tester  
 D Analoges Batterieprüfgerät  
 PL Tester akumulatorów analogowy  
 RUS Аналоговый тестер аккумуляторов  
 CZ Analogový tester akumulátorů  
 H Analóg akkuteszter  
 RO Tester acumulatori analog  
 E Tester analógico para acumuladores

GB Digital battery tester  
 D Digitales Batterieprüfgerät  
 PL Tester akumulatorów cyfrowy  
 RUS Цифровой тестер аккумуляторов  
 CZ Digitální tester akumulátorů  
 H Digitális akkuteszter  
 RO Tester acumulatori digital  
 E Tester digital para acumuladores

GB Battery tester  
 D Batterieprüfgerät  
 PL Tester akumulatorów  
 RUS Тестер аккумуляторов  
 CZ Tester akumulátorů  
 H Akkuteszter  
 RO Tester acumulatori  
 E Tester para acumuladores



COLOR BOX



YT-8310

10



COLOR BOX



YT-8311

10



DOUBLE BLISTER



YT-83101

12/72

# Measuring tools Narzędzia miernicze

GB Digital universal multimeter  
 D Universell digital Messgerät  
 PL Cyfrowy miernik uniwersalny  
 RUS Универсальный цифровой измеритель  
 CZ Digitální multimetr univerzální  
 H Digitális multiméter  
 RO Multimetru digital universal  
 E Manómetro digital universal



COLOR BOX



COLOR BOX



COLOR BOX

YT-73080 50

YT-73082 30

YT-73084 44



NYLON CASE & COLOR BOX



NYLON CASE & COLOR BOX



COLOR BOX

YT-73086 24

YT-73087 24

YT-73088 20



NYLON CASE & COLOR BOX

YT-73091 20

GB Measuring tape PL Miara zwiżana CZ Měřící pásma RO Rulete din pinza  
 D Rollbandmass RUS Рулетка H Mérőszalag E Flexómetro



|         | L (m) | size / rozmiar (mm) |        |
|---------|-------|---------------------|--------|
| YT-7103 | 3     | 16                  | 12/120 |
| YT-7105 | 5     | 19                  | 12/120 |



|         | L (m) | size / rozmiar (mm) |        |
|---------|-------|---------------------|--------|
| YT-7110 | 3     | 16                  | 12/120 |
| YT-7111 | 5     | 25                  | 12/120 |
| YT-7112 | 8     | 25                  | 6/60   |



|         | L (m) | size / rozmiar (mm) |        |
|---------|-------|---------------------|--------|
| YT-7116 | 3     | 16                  | 12/120 |
| YT-7117 | 5     | 19                  | 12/120 |
| YT-7118 | 8     | 25                  | 6/60   |



|         | L (m) | size / rozmiar (mm) |        |
|---------|-------|---------------------|--------|
| YT-7126 | 3     | 16                  | 12/120 |
| YT-7127 | 5     | 19                  | 12/120 |
| YT-7128 | 8     | 25                  | 6/60   |



|         | L (m) | size / rozmiar (mm) |        |
|---------|-------|---------------------|--------|
| YT-7129 | 3     | 16                  | 12/120 |
| YT-7130 | 5     | 19                  | 12/120 |
| YT-7131 | 8     | 25                  | 6/60   |



|          | L (m) | size / rozmiar (mm) |           |
|----------|-------|---------------------|-----------|
| YT-71130 | 3     | 16                  | 12 60/120 |
| YT-71131 | 5     | 19                  | 12 48/96  |
| YT-71133 | 8     | 25                  | 12 18/36  |



|          | L (m) | size / rozmiar (mm) |        |
|----------|-------|---------------------|--------|
| YT-71135 | 3     | 16                  | 12/144 |
| YT-71136 | 5     | 19                  | 12/72  |
| YT-71138 | 8     | 25                  | 8/48   |



\* - product not for european market  
 \* - produkt nieprzeznaczony na rynek europejski

|           | L             | size / rozmiar |        |
|-----------|---------------|----------------|--------|
| YT-71140* | 2 m / 6 ft    | 16 mm / 5/8"   | 12/144 |
| YT-71141  | 3 m / 10 ft   | 16 mm / 5/8"   | 12/144 |
| YT-71142* | 3.5 m / 12 ft | 16 mm / 5/8"   | 12/144 |
| YT-71143  | 5 m / 16 ft   | 19 mm / 3/4"   | 12/96  |
| YT-71144* | 5.5 m / 18 ft | 25 mm / 1"     | 12/72  |
| YT-71145  | 7.5 m / 25 ft | 25 mm / 1"     | 12/48  |
| YT-71146  | 10 m / 33 ft  | 25 mm / 1"     | 12/36  |



## Measuring tools Narzędzia miernicze

GB Measuring tape H Mérőszalag  
D Rollbandmass RO Rulete din pinza  
PL Miara zwijana E Flexómetro  
RUS Рулетка  
CZ Měřicí pásmo

\* - product not for european market  
\* - produkt nieprzeznaczony na rynek europejski



DISPLAY BOX



DOUBLE BLISTER



DOUBLE BLISTER

|          | L (m) | size / rozmiar (mm) |    |        |
|----------|-------|---------------------|----|--------|
| YT-71181 | 3     | 16                  | 12 | 60/120 |
| YT-71182 | 5     | 19                  | 12 | 36/72  |
| YT-71184 | 8     | 25                  | 12 | 24/48  |

|          | L (m) | size / rozmiar (mm) |    |        |
|----------|-------|---------------------|----|--------|
| YT-71185 | 2     | 16                  | 12 | 12/144 |
| YT-71186 | 3     | 16                  | 12 | 12/120 |
| YT-71187 | 5     | 19                  | 12 | 12/72  |
| YT-71188 | 8     | 25                  | 6  | 6/36   |
| YT-71189 | 10    | 25                  | 6  | 6/36   |

|          | L (m) | size / rozmiar (mm) |    |        |
|----------|-------|---------------------|----|--------|
| YT-7149* | 2     | 16                  | 12 | 12/144 |
| YT-7150* | 3     | 16                  | 12 | 12/144 |
| YT-7151* | 5     | 19                  | 12 | 12/96  |
| YT-7152* | 5     | 25                  | 12 | 12/96  |
| YT-7153* | 8     | 25                  | 6  | 6/48   |
| YT-7154* | 10    | 25                  | 12 | 12/48  |

GB Steel measuring tape CZ Měřicí pásmo ocelové  
D Rollbandmass H Acél mérőszalag  
PL Taśma miernicza stalowa RO Ruleta sticla  
RUS Мерная лента стальная E Cinta de medir de acero



PAPER HANGER

|          | L (m) | size / rozmiar (mm) |      |
|----------|-------|---------------------|------|
| YT-71560 | 20    | 13                  | 5/20 |
| YT-71561 | 30    | 13                  | 5/20 |
| YT-71562 | 50    | 13                  | 5/20 |

GB Fibreglass measuring tape CZ Měřicí pásmo  
D Rollbandmass - skleněné vlákno  
PL Taśma miernicza H Mérőszalag - üvegszál  
z włókna szklanego RO Ruleta fibra sticla  
RUS Мерная лента фиберглас E Cinta de medir - fibra cristal



PAPER HANGER

|          | L (m) | size / rozmiar (mm) |      |
|----------|-------|---------------------|------|
| YT-71565 | 20    | 15                  | 5/40 |
| YT-71566 | 30    | 15                  | 5/20 |
| YT-71567 | 50    | 15                  | 5/20 |

GB Steel survey tape H Acél mérőszalag, geodéziai  
D Rollbandmass RO Bandă de măsură pt. geodezie  
PL Miara geodezyjna stalowa E Cinta de medir de acero  
RUS Мерная лента стальная  
CZ Měřicí pásmo ocelové geodetické

GB Fibreglass survey tape CZ Měřicí pásmo - skleněné vlákno  
D Rollbandmass H Mérőszalag - üvegszál  
PL Miara geodezyjna RO Ruleta fibra sticla  
z włókna szklanego E Cinta de medir - fibra cristal  
RUS Мерная лента фиберглас



COLOR BOX

|          | L (m) | size / rozmiar (mm) |    |
|----------|-------|---------------------|----|
| YT-71551 | 30    | 13                  | 10 |
| YT-71552 | 50    | 13                  | 10 |



COLOR BOX

|          | L (m) | size / rozmiar (mm) |    |
|----------|-------|---------------------|----|
| YT-71555 | 30    | 13                  | 10 |
| YT-71556 | 50    | 13                  | 10 |

GB Folding rule PL Miara składana CZ Měřicí pásmo skladané RO Metru armat  
 D Klappbares Massband RUS Метр складной H Famérce E Metro plegable

3.2 mm



SEGMENTS THICKNESS  
GRUBOŚĆ LISTEWK



HANGING  
CARD



- non drilled segments - increased stiffness
- listewki nie przewiercane - zwiększona sztywność

|         | L (m) | size / rozmiar (mm) |        |
|---------|-------|---------------------|--------|
| YT-7090 | 1     | 16                  | 20/400 |
| YT-7091 | 2     | 16                  | 10/200 |

GB Aluminium ruler PL Przymiar aluminiowy CZ Měřicí lat hliníková RO Riglă tâmplar din aluminiu  
 D Alu zeichen-massstab RUS Линейка алюминиевая H Asztalos vonalzó, alumínium E Regla de aluminio



|         | L (mm) |        |
|---------|--------|--------|
| YT-7070 | 300    | 25/100 |
| YT-7071 | 600    | 10/50  |

GB Aluminium try square PL Kałownik aluminiowy CZ Truhlářský úhelník RO Echer de tâmplărie E Escuadra de aluminio  
 D Anschlagwinkel RUS Угольник столярный H Asztalos derékszög



|         | L (mm) |      |
|---------|--------|------|
| YT-7080 | 250    | 6/36 |
| YT-7081 | 300    | 6/36 |
| YT-7082 | 350    | 6/36 |

GB Aluminium try square PL Kałownik aluminiowy CZ Truhlářský úhelník RO Echer de tâmplărie E Escuadra de aluminio  
 D Anschlagwinkel RUS Угольник столярный H Asztalos derékszög



|         | size / rozmiar (mm) |        |
|---------|---------------------|--------|
| YT-7083 | 150 x 300           | 25/100 |
| YT-7084 | 250 x 500           | 10/50  |

GB Vernier caliper PL Suwmiarka CZ Posuvné měřítko H Tolóméró RO Şubler E Calibre  
 D Messschieber RUS Штангенциркуль

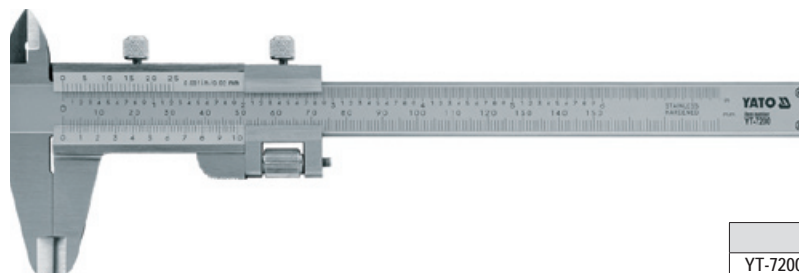

PLASTIC CASE  
& COLOR BOX



|         |       |
|---------|-------|
| YT-7200 | 10/50 |
|---------|-------|

GB Digital caliper PL Suwmiarka elektroniczna CZ Posuvné měřítko elektronické H Elektronikus tolómér RO Şubler electronic E Calibre electrónico  
 D Digital Messschieber RUS Штангенциркуль электронный

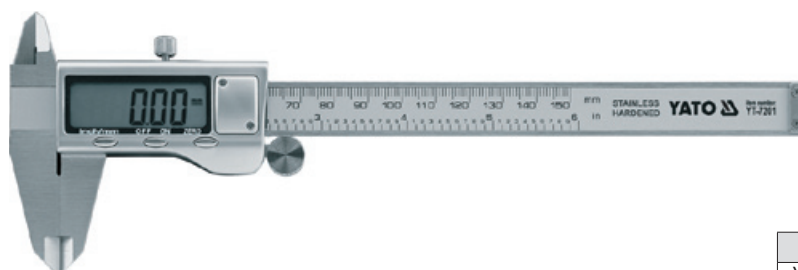

PLASTIC CASE  
& COLOR BOX



|         |       |
|---------|-------|
| YT-7201 | 10/50 |
|---------|-------|

## Measuring tools Narzędzia miernicze

GB Aluminium level      *RUS* Уровень      *RO* Cumpănă  
*D* Wasserwaage      *CZ* Vodováha      *E* Nivel  
*PL* Poziomnica aluminiowa      *H* Vízmerők



COLOR SLEEVE



| L (mm)  |      |       |
|---------|------|-------|
| YT-3001 | 400  | 20/60 |
| YT-3002 | 600  | 20/60 |
| YT-3003 | 800  | 20/60 |
| YT-3004 | 1000 | 20/60 |
| YT-3005 | 1200 | 20/60 |



| L (mm)  |      |       |
|---------|------|-------|
| YT-3022 | 600  | 20/60 |
| YT-3023 | 800  | 20/60 |
| YT-3024 | 1000 | 30    |
| YT-3025 | 1200 | 30    |
| YT-3026 | 1500 | 30    |

GB Aluminium level      *RUS* Уровень      *RO* Cumpănă  
*D* Wasserwaage      *CZ* Vodováha      *E* Nivel  
*PL* Poziomnica aluminiowa      *H* Vízmerők



COLOR SLEEVE



\* - product not for european market  
 \* - produkt nieprzeznaczony na rynek europejski

| L (mm)   |      |    |
|----------|------|----|
| YT-3007  | 600  | 20 |
| YT-3008  | 800  | 20 |
| YT-3009* | 1000 | 15 |
| YT-3010* | 1200 | 15 |



\* - product not for european market  
 \* - produkt nieprzeznaczony na rynek europejski

| L (mm)   |      |    |
|----------|------|----|
| YT-3016* | 600  | 20 |
| YT-3017* | 800  | 20 |
| YT-3018* | 1000 | 15 |
| YT-3019  | 1200 | 15 |



\* - product not for european market  
 \* - produkt nieprzeznaczony na rynek europejski

| L (mm)   |      |    |
|----------|------|----|
| YT-3027* | 600  | 20 |
| YT-3028* | 800  | 20 |
| YT-3030* | 1200 | 15 |
| YT-3031* | 1500 | 10 |
| YT-3032* | 1800 | 10 |

GB Feeler      *H* Hézagmérő  
*D* Fühlertlehre      *RO* Lere  
*PL* Szczelinomierz      *E* Calibre  
*RUS* Щупы      *H* de fisuras  
*CZ* Spároměr

DOUBLE  
BLISTER



| L (mm)  | width / szerokość | size / rozmiar   |
|---------|-------------------|--|
| YT-7220 | 100               | 10   |
|         |                   | 0.02, 0.03, 0.04, 0.05, 0.06, 0.07, 0.08, 0.09, 0.10, 0.15, 0.20, 0.25, 0.30, 0.40, 0.50, 0.75, 1.00 |
|         |                   | 10/200   |

| L (mm)  | width / szerokość | size / rozmiar   |
|---------|-------------------|--|
| YT-7221 | 200               | 12.8   |
|         |                   | 0.02, 0.03, 0.04, 0.05, 0.06, 0.07, 0.08, 0.09, 0.10, 0.15, 0.20, 0.25, 0.30, 0.40, 0.50, 0.75, 1.00 |
|         |                   | 10/100   |



| L (mm)  | width / szerokość | size / rozmiar   |
|---------|-------------------|--|
| YT-7222 | 100               | 10   |
|         |                   | 0.05, 0.06, 0.07, 0.08, 0.09, 0.10, 0.20, 0.30, 0.40, 0.50 |
|         |                   | 10/100   |

| L (mm)  | width / szerokość | size / rozmiar   |
|---------|-------------------|--|
| YT-7223 | 200               | 12.8   |
|         |                   | 0.05, 0.06, 0.07, 0.08, 0.09, 0.10, 0.15, 0.20, 0.25, 0.30, 0.35, 0.40, 0.45, 0.50 |
|         |                   | 10/100   |

# 15

## Pneumatic tools Narzędzia pneumatyczne



## Pneumatic tools Narzędzia pneumatyczne

### Compressors Kompresory

254



### Pneumatic accessories

Akcesoria instalacji pneumatycznej

262



### Impact wrenches Klucze udarowe

254-256



### Air filters, regulators & lubricators

Filtry, reduktory i smarownice.....

262

### Couplers

Złącza.....

262

### Impact wrenches 1/2"

Klucze udarowe 1/2".....

254

### Impact wrenches 3/4"

Klucze udarowe 3/4".....

255

### Impact wrenches 1"

Klucze udarowe 1".....

256

### Pneumatic riveters

Nitownice pneumatyczne

263



### Other air tools

Inne narzędzia pneumatyczne

257-260



### Pneumatic stitching & nailing machines

Zszywacze i gwoździarki pneumatyczne

263-264



### Pneumatic ratchets & sets

Grzechotki pneumatyczne i zestawy.....

257

### Pneumatic grinders & sets

Szlifierki pneumatyczne i zestawy.....

258

### Pneumatic cut-off tools & discs

Przecinarki pneumatyczne i tarcze.....

259

### Pneumatic drills

Wiertarki pneumatyczne.....

259

### Pneumatic hammers

Młotki pneumatyczne.....

259

### Tire inflating guns & heads

Pistolety do pompowania kół i głowice.....

260

### Pneumatic staplers

Zszywacze pneumatyczne.....

263

### Pneumatic nailers

Gwoździarki pneumatyczne.....

263

### Mini palm nailers

Młotki pneumatyczne do gwoździ

264



### Painting equipment

Narzędzia do malowania

260-261



### Spray guns

Pistolety lakiernicze.....

260

### Accessories for spray guns

Akcesoria do pistoletów lakierniczych.....

260

### Inflating guns

Pistolety do przedmuchiwania.....

261

### Washing guns

Pistolety do ropowania.....

261

### Air sand blasters

Pistolety do piaskowania.....

261

- GB Oil type piston compressor
- D Druckluft Kompressor ölhaltig
- PL Kompresor olejowy
- RUS Масляный компрессор
- CZ Kompresor vzduchový olejový
- H Kompreszor, olajos, fekvő tartályos
- RO Compresor aer cu ulei
- E Compresor de aire comprimido



|          |   |
|----------|---|
| YT-23220 | 1 |
|----------|---|

- GB Impact wrench
- CZ Klíč pneumatický
- D Druckluft-Schlagschrauber
- H Pneumatikus ütvecsavarozó
- PL Klucz udarowy
- RO Pistol pneumatic
- RUS Ударный пневматический гайковерт
- E Llave neumática de percusión

- GB Impact wrench
- CZ Klíč pneumatický
- D Druckluft-Schlagschrauber
- H Pneumatikus ütvecsavarozó
- PL Klucz udarowy
- RO Pistol pneumatic
- RUS Ударный пневматический гайковерт
- E Llave neumática de percusión



|          | Nm  |   |
|----------|-----|---|
| YT-0951* | 623 | 5 |



|         | Nm  |   |
|---------|-----|---|
| YT-0952 | 540 | 8 |

\* - product not for european market  
\* - produkt nieprzeznaczony na rynek europejski

## Pneumatic tools Narzędzia pneumatyczne

GB Impact wrench  
D Druckluft-Schlagschrauber  
PL Klucz udarowy  
RUS Ударный пневматический гайковерт

CZ Klíč pneumatický  
H Pneumatikus ütvecsavarozó  
RO Pistol pneumatic  
E Llave neumática de percusión



**TWIN HAMMER™**  
mechanism  
ensuring resilience  
to damage and  
overload

COLOR  
BOX



|         | Nm  |    |
|---------|-----|----|
| YT-0950 | 475 | 10 |

GB Impact wrench  
D Druckluft-Schlagschrauber  
PL Klucz udarowy  
RUS Ударный пневматический гайковерт

CZ Klíč pneumatický  
H Pneumatikus ütvecsavarozó  
RO Pistol pneumatic  
E Llave neumática de percusión



- application: industry
- the highest torque in ½" class wrenches
- low weight
- integrated torque regulator
- composite housing
- przeznaczenie: przemysł
- największa moc w klasie kluczy ½"
- niska waga
- zintegrowany regulator momentu obrotowego
- obudowa kompozytowa

**TWIN HAMMER™**  
mechanism  
ensuring resilience  
to damage and  
overload

COLOR  
BOX



|         | Nm   |    |
|---------|------|----|
| YT-0953 | 1356 | 10 |

GB Impact wrench  
D Druckluft-Schlagschrauber  
PL Klucz udarowy  
RUS Ударный пневматический гайковерт

CZ Klíč pneumatický  
H Pneumatikus ütvecsavarozó  
RO Pistol pneumatic  
E Llave neumática de percusión



- application: automotive service stations, vans and cars
- przeznaczenie: serwis, samochody dostawcze i osobowe

COLOR  
BOX



|         | Nm  |   |
|---------|-----|---|
| YT-0956 | 945 | 4 |

GB Impact wrench  
D Druckluft-Schlagschrauber  
PL Klucz udarowy  
RUS Ударный пневматический гайковерт

CZ Klíč pneumatický  
H Pneumatikus ütvecsavarozó  
RO Pistol pneumatic  
E Llave neumática de percusión



**TWIN HAMMER™**  
mechanism  
ensuring resilience  
to damage and  
overload

COLOR  
BOX



|         | Nm   |   |
|---------|------|---|
| YT-0957 | 1626 | 2 |

GB Pneumatic wrench  
 D Druckluft-Schlüssel  
 PL Klucz udarowy  
 RUS Пневматический ключ  
 CZ Pneumatický utahovák  
 H Pneumatikus kulcs  
 RO Cheie pneumatica  
 E Llave neumática

**PINLESS HAMMER™**

**closed hammer cage mechanism prevents breakage from hammer pin damage**



- application: automotive service stations, trucks
- przeznaczenie: serwis, samochody ciężarowe
- strong, uniform impact
- silny, jednolity uder



|         | Nm   |   |
|---------|------|---|
| YT-0959 | 2600 | 2 |

GB Pneumatic wrench  
 D Druckluft-Schlüssel  
 PL Klucz udarowy  
 RUS Пневматический ключ  
 CZ Pneumatický utahovák  
 H Pneumatikus kulcs  
 RO Cheie pneumatica  
 E Llave neumática

**PINLESS HAMMER™**

**closed hammer cage mechanism prevents breakage from hammer pin damage**

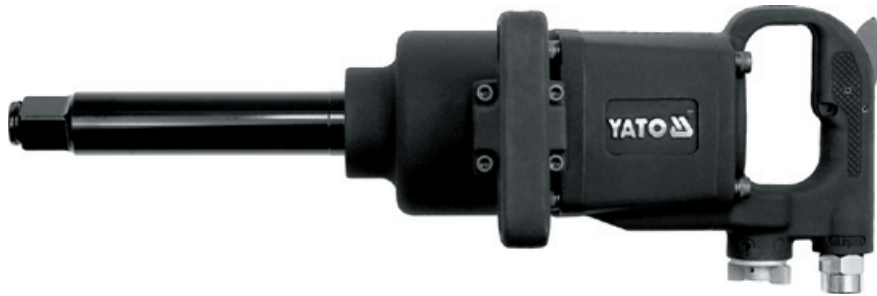

- application: automotive service stations, trucks
- przeznaczenie: serwis, samochody ciężarowe
- strong, uniform impact
- silny, jednolity uder



|         | Nm   |   |
|---------|------|---|
| YT-0960 | 2600 | 2 |

GB Pneumatic wrench  
 D Druckluft-Schlüssel  
 PL Klucz udarowy  
 RUS Пневматический ключ

CZ Pneumatický utahovák  
 H Pneumatikus kulcs  
 RO Cheie pneumatica  
 E Llave neumática



- application: industry, service stations, tire service stations, truck service
- the lightest 1" impact wrench with torque of 2800 Nm
- magnesium alloy and composite housing
- low vibration
- low air consumption
- przeznaczenie: przemysł, serwisy mobilne i stacjonarne, serwisy opon oraz pojazdów ciężarowych
- najlżejszy klucz udarowy w klasie 1" o mocy 2800 Nm
- obudowa ze stopów magnezu i kompozytu
- niski poziom wibracji
- małe zużycie powietrza

**TWIN HAMMER™**

**mechanism ensuring resilience to damage and overload**



COLOR BOX



|         | Nm   |   |
|---------|------|---|
| YT-0961 | 2800 | 2 |



## Pneumatic tools Narzędzia pneumatyczne

- GB Ratchet air wrench  
D Druckluft-Ratschenschrauber  
PL Grzechotka pneumatyczna  
RUS Пневмотрещотка  
CZ Utahovák vzduchový  
H Préslevegős behajtó szerszám  
RO Antrenor pneumatic  
E Carraca neumática



COLOR BOX



|         | Nm |    |
|---------|----|----|
| YT-0983 | 34 | 20 |

- GB Ratchet air wrench  
D Druckluft-Ratschenschrauber  
PL Grzechotka pneumatyczna  
RUS Пневмотрещотка  
CZ Utahovák vzduchový  
H Préslevegős behajtó szerszám  
RO Antrenor pneumatic  
E Carraca neumática



COLOR BOX



|         | Nm |    |
|---------|----|----|
| YT-0984 | 95 | 15 |

- GB Ratchet air wrench  
D Druckluft-Ratschenschrauber  
PL Grzechotka pneumatyczna  
RUS Пневмотрещотка  
CZ Utahovák vzduchový  
H Préslevegős behajtó szerszám  
RO Antrenor pneumatic  
E Carraca neumática



COLOR BOX



|         | Nm |    |
|---------|----|----|
| YT-0981 | 80 | 20 |

- GB Ratchet air wrench  
D Druckluft-Ratschenschrauber  
PL Grzechotka pneumatyczna  
RUS Пневмотрещотка  
CZ Utahovák vzduchový  
H Préslevegős behajtó szerszám  
RO Antrenor pneumatic  
E Carraca neumática



COLOR BOX



|         | Nm |    |
|---------|----|----|
| YT-0980 | 68 | 20 |

- GB Ratchet wrench kit  
D Druckluft-Ratschenschrauber mit Zubehör  
PL Zestaw z grzechotką pneumatyczną  
RUS Пневмотрещотка в наборе  
CZ Klíč ráčnový pneumatický s příslušenstvím  
H Pneumatikus racsnikulcs készlet  
RO Cheie pneumatica cu accesorii  
E Juego con carraca neumática



1/2" (12.7 mm), L=75 mm;  
6 mm x 1/2" (12.7 mm);  
1/2" (12.7 mm);  
H4, H5, H6, H7, H8;  
T20, T25, T27, T30, T40;  
5.5, 6.5, 8.0 mm;  
PH2, PH3, PH4;  
10, 11, 12, 13, 14, 17, 19 mm

BMC & COLOR SLEEVE



|         | Nm |   |
|---------|----|---|
| YT-0982 | 68 | 4 |

- GB Air grinder
- D Drucklufteinhandschleifer
- PL Szlifierka pneumatyczna prosta
- RUS Шлифмашина пневматическая
- CZ Bruska přímá pneumatická
- H Préslevegős sarokcsiszoló
- RO Polizor pneumatic
- E Lijadora neumática recta



COLOR BOX



|         |    |
|---------|----|
| YT-0965 | 25 |
|---------|----|

- GB Air grinder
- D Drucklufteinhandschleifer
- PL Szlifierka pneumatyczna prosta
- RUS Шлифмашина пневматическая
- CZ Bruska přímá pneumatická
- H Préslevegős sarokcsiszoló
- RO Polizor pneumatic
- E Lijadora neumática recta



COLOR BOX



|         |    |
|---------|----|
| YT-0963 | 20 |
|---------|----|

- GB Die grinder kit
- D Druckluft-Schrauber mit Schleifaufsätzen
- PL Pneumatyczna szlifierka prosta z akcesoriami
- RUS Комплект для шлифования
- CZ Bruska přímá pneumatická s příslušenstvím
- H Pneumatikus kőszűrű készlet
- RO Masina de polizat pneumatica
- E Lijadora neumática recta



BMC & COLOR SLEEVE



|         |    |
|---------|----|
| YT-0964 | 10 |
|---------|----|

- GB Air sander
- D Druckluft-Excenterschleifer
- PL Szlifierka pneumatyczna mimośrodowa
- RUS Шлифмашина эксцентриковая пневматическая
- CZ Bruska pneumatická
- H Pneumatikus sarokcsiszológép
- RO Masina de slefuit pneumatica
- E Lijadora neumática excéntrica



COLOR BOX



|         |    |
|---------|----|
| YT-0967 | 10 |
|---------|----|

- GB Air sander
- D Druckluft-Excenterschleifer
- PL Szlifierka pneumatyczna mimośrodowa
- RUS Шлифмашина эксцентриковая пневматическая
- CZ Bruska pneumatická
- H Pneumatikus sarokcsiszológép
- RO Masina de slefuit pneumatica
- E Lijadora neumática excéntrica



COLOR BOX



|         |    |
|---------|----|
| YT-0974 | 10 |
|---------|----|

- GB Disc for air sander
- D Stützteller für Druckluftexcenterschleifer
- PL Tarcza polerska do szlifierki pneumatycznej
- RUS Диск полировочный для пневмошлифмашины
- CZ Disk pro pneumatickou brusku
- H Csiszolókorong pneumatikus gépekhez
- RO Masina disc pt. slefuit
- E Recambio disco lijadora orbital neumática



for / dla: YT-0974

DOUBLE BLISTER



|         |       |
|---------|-------|
| YT-0975 | 10/60 |
|---------|-------|

## Pneumatic tools Narzędzia pneumatyczne

GB Air sander  
D Druckluft-Excenterschleifer  
PL Szlifierka pneumatyczna oscylacyjna  
RUS Шлифмашина эксцентриковая пневматическая  
CZ Bruska pneumatická  
H Pneumatikus sarokcsiszológép  
RO Masina de slefuit pneumatica  
E Lijadora neumática excéntrica



COLOR BOX

YT-0976 10

GB Air sander  
D Druckluft-Excenterschleifer  
PL Szlifierka pneumatyczna oscylacyjna  
RUS Шлифмашина эксцентриковая пневматическая  
CZ Bruska pneumatická  
H Pneumatikus sarokcsiszológép  
RO Masina de slefuit pneumatica  
E Lijadora neumática excéntrica



COLOR BOX

YT-0977 10

GB Air cut-off tool  
D Druckluft-Schneidmaschine  
PL Przecinarka pneumatyczna  
RUS Резак пневматический  
CZ Příčná bruska pneumatická

H Pneumatikus sarokcsiszoló  
RO Masina de taiat cu aer comprimat  
E Cortadora neumática



COLOR BOX

YT-0993 20

GB Metal cutting disc  
D Metall-Trennscheibe  
PL Tarcza do cięcia metalu  
RUS Круги отрезные по металлу  
CZ Souprava kotoučů pro řezání kovu  
H Vágókorong fémhez  
RO Set de pânze de tăiat metal  
E Disco cortador para metal

for / dla: YT-0993



BLISTER CARD

YT-0994 12/48

GB Reversible air drill  
D Druckluft-Bohrmaschine mit Stahl-Zahnkranzfutter  
PL Wiertarka pneumatyczna  
RUS Пневматическая дрель

CZ Vrtačka ruční vzduchová  
H Préselevgős fúrógép  
RO Masina de gaurit pneumatica mandrina  
E Taladradora neumática



COLOR BOX

YT-0970 20

GB Air hammer  
D Druckluft-Schlaghammer  
PL Młotek pneumatyczny  
RUS Зубило пневматическое  
CZ Sekáč vzduchový

H Pneumatikus vésőkészlet pisztollyal  
RO Ciosam cu aer comprimat  
E Martillo neumático



COLOR BOX

YT-0990 10

- GB Tire-inflating gun  
 D Reifenfüller  
 PL Pistolet do pompowania kół  
 RUS Пистолет для накачивания колёс  
 CZ Pistole na čerpaní z manometrem  
 H Gumiabroncs pumpáló  
 RO Pistol cu manometru pt. pompat  
 E Pistola de bombeo con manometro



SLIDING CARD

|         |      |
|---------|------|
| YT-2370 | 8/40 |
|---------|------|

- GB Universal head  
 D Klemmnippel (universal)  
 PL Glowica do pompowania  
 RUS Универсальная головка  
 CZ Hlava na čerpaní  
 H Pumpafej  
 RO Cap pt. pompat  
 E Cabeza de bombeo



DOUBLE BLISTER

|         |      |        |
|---------|------|--------|
|         | (mm) |        |
| YT-2371 | 6    | 50/300 |
| YT-2372 | 8    | 50/300 |

- GB Spray gun with fluid cup  
 D Lackierpistole mit Fließbecher  
 PL Pistolet natryskowy

- RUS Пистолет - распылитель с верхним бачком  
 CZ Pistole na lakování z nádrží

- H Festópisztoly alsó tartállyal  
 RO Pistol de vopsit cu rezervor inferior  
 E Pistola de barniz

COLOR BOX



\* - product not for european market  
 \* - produkt nieprzeznaczony na rynek europejski



|          |    |          |    |          |    |          |    |
|----------|----|----------|----|----------|----|----------|----|
| YT-2350* | 10 | YT-2351* | 10 | YT-2353* | 10 | YT-2356* | 10 |
|----------|----|----------|----|----------|----|----------|----|

15



|         |    |         |    |         |    |         |    |
|---------|----|---------|----|---------|----|---------|----|
| YT-2340 | 20 | YT-2341 | 20 | YT-2346 | 10 | YT-2357 | 20 |
|---------|----|---------|----|---------|----|---------|----|

- GB Plastic tank  
 D Fließbecher für Spritzpistole  
 PL Zbiornik plastikowy  
 RUS Пластмассовый бачок  
 CZ Plastová nádrž  
 H Műanyag tartály  
 RO Rezervor de plastic  
 E Recipiente de plástico



COLOR BOX



- GB Nozzle set for / dla: YT-2350  
 D Düsen-Reparatur-Satz  
 PL Zestaw naprawczy dysz  
 RUS Комплект дюз для покрасочных пистолетов  
 CZ Soustava na opravování trysek  
 H Fúvókajavitó készlet  
 RO Set pt. reparații diuze  
 E Juego de reparación para toberas



COLOR BOX

|          |    |         |     |         |    |
|----------|----|---------|-----|---------|----|
| YT-2363* | 20 | YT-2364 | 100 | YT-2361 | 80 |
|----------|----|---------|-----|---------|----|

\* - product not for european market  
 \* - produkt nieprzeznaczony na rynek europejski

- GB Inflating gun with extension  
D Gebläsepistole mit Verlängerung  
PL Pistolet do przedmuchiwania z przedłużką  
RUS Пистолет для продувки с удлинителем  
CZ Pistole na profukování dlouhá  
H Rövid előléfűvő pisztoly  
RO Pistol lung pt. suflat  
E Pistola de soplado



SLIDING  
CARD

YT-2373 20/40

- GB Washing gun  
D Waschpistole  
PL Pistolet do ropowania  
RUS Пистолет для нефтешланца  
CZ Pistole na ropování + nádrž  
H Olajzópisztoly + tartály  
RO Pistol (dozator)  
cu rezervor pt. motorină  
E Pistola de petrolear



COLOR  
BOX

YT-2374 2/12

- GB Air sand blaster  
D Pistole zum Sandstrahlen  
PL Pistolet do piaskowania z węzłem  
RUS Пескоструйный пистолет  
CZ Pískovací pistole s hadicí  
H Homokszóró pisztoly tömlővel  
RO Pistol de sablat  
E Pistola para limpieza con chorro  
de arena con manguera



SLIDING  
CARD

YT-2375 10

- GB Gun suitable for sand-blasting  
D Sandstrahlpistole  
PL Pistolet do piaskowania ze zbiornikiem  
RUS Пескоструйный пистолет  
CZ Pískovací pistole se zásobníkem  
H Homokszóró pisztoly tartállyal  
RO Pistol de sablat  
E Pistola para limpieza con chorro  
de arena con recip



COLOR  
BOX

YT-2376 20

GB Mini filter  
D Filter  
PL Filtr  
RUS Минифильтр  
CZ Filtr  
H Szűrő  
RO Minifiltru  
E Filtro



COLOR BOX

YT-2380 25/50

GB Pressure reducing valve with manometer  
D Druckminderer mit Manometer  
PL Reduktor ciśnienia z manometrem  
RUS Клапан уменьшения давления с манометром  
CZ Redukční ventil s manometrem  
H Nyomáscsökkentő szelep nyomásmérővel  
RO Valva cu reductiepresiune + manometru  
E Reductor + manometro



COLOR BOX

YT-2381 25/50

GB Filter - reducer  
D Druckfilter - Druckminderer  
PL Filtr - reduktor  
RUS Фильтр - редуктор  
CZ Filtr derukční ventil  
H Szűrő - nyomáscsökkentő szelep  
RO Filtru cu reductor  
E Reductor + filtro



COLOR BOX

YT-2382 25/50

GB Filter - reducer  
D Druckfilter - Druckminderer  
PL Filtr - reduktor  
RUS Фильтр - редуктор  
CZ Filtr derukční ventil  
H Szűrő - nyomáscsökkentő szelep  
RO Filtru cu reductor  
E Reductor + filtro



COLOR BOX



YT-2383 25/50

GB Air filter regulator and lubricator  
D Druckfilter - Druckminderer + Entöler  
PL Zespół filtrujący reduktor + smarownica  
RUS Фильтр-редуктор  
CZ Redukční ventil s odlučovačem oleje  
H Levegőelőkészítő  
RO Filtru cu reductor  
E Juego de filtro reductor + engrasador



COLOR BOX



YT-2384 25/50

GB Air filter regulator and lubricator  
D Druckfilter - Druckminderer + Entöler  
PL Zespół filtrujący reduktor + smarownica  
RUS Фильтр-редуктор  
CZ Redukční ventil s odlučovačem oleje  
H Levegőelőkészítő  
RO Filtru cu reductor  
E Juego de filtro reductor + engrasador



COLOR BOX



YT-2385 25

GB Quick coupler  
D Schnellkupplung  
PL Szybkozłącze  
RUS Быстрое соединение  
CZ Rychlospojka  
H Gyorscsatlakozó  
RO Mufa rapida pt. pistol pneumatic  
E Conexión de la entrada de aire

SLIDING CARD



|         | size / rozmiar |        |
|---------|----------------|--------|
| YT-2390 | 1/4" (6.3 mm)  | 50/250 |
| YT-2391 | 3/8" (10.0 mm) | 50/250 |
| YT-2392 | 1/2" (12.5 mm) | 50/250 |

|         | size / rozmiar |        |
|---------|----------------|--------|
| YT-2393 | 1/4" (6.3 mm)  | 50/250 |
| YT-2394 | 3/8" (10.0 mm) | 50/250 |
| YT-2395 | 1/2" (12.5 mm) | 50/250 |

|         | size / rozmiar |        |
|---------|----------------|--------|
| YT-2396 | 1/4" (6.3 mm)  | 50/250 |
| YT-2397 | 3/8" (10.0 mm) | 50/250 |
| YT-2398 | 1/2" (12.5 mm) | 50/250 |



|         | size / rozmiar |        |
|---------|----------------|--------|
| YT-2399 | 1/4" (6.3 mm)  | 50/250 |
| YT-2401 | 3/8" (10.0 mm) | 50/250 |
| YT-2402 | 1/2" (12.5 mm) | 50/250 |

|         | size / rozmiar |        |
|---------|----------------|--------|
| YT-2403 | 1/4" (6.3 mm)  | 50/250 |
| YT-2404 | 3/8" (10.0 mm) | 50/250 |

|         | size / rozmiar |        |
|---------|----------------|--------|
| YT-2405 | 1/4" (6.3 mm)  | 50/250 |
| YT-2406 | 3/8" (10.0 mm) | 50/250 |
| YT-2407 | 1/2" (12.5 mm) | 50/250 |

## Pneumatic tools Narzędzia pneumatyczne

GB Pneumatic riveting machine  
D Pneumatische Nietvorrichtung  
PL Nitownica pneumatyczna  
RUS Пневматический заклепочник

CZ Pneumatická nýtovačka  
H Pneumatikus popszegecshűző  
RO Presa pneumatica de nituri  
E Máquina remachadora

COLOR  
BOX



- application: industry
- przeznaczenie: przemysł

|         | (mm)               | L (mm) | F (kg) | F (N)   |
|---------|--------------------|--------|--------|---------|
| YT-3617 | 2.4; 3.2; 4.0; 4.8 | 14     | 850    | 8335 10 |



- application: industry
- przeznaczenie: przemysł

|         | (mm)                    | L (mm) | F (kg) | F (N)   |
|---------|-------------------------|--------|--------|---------|
| YT-3618 | 2.4; 3.2; 4.0; 4.8; 6.4 | 16     | 1389   | 13620 6 |

GB Pneumatic stitching machine  
D Druckluftheft  
PL Zszywacz pneumatyczny  
RUS Пневматический шиватель  
CZ Pneumatická sešivačka  
H Pneumatikus tűzőgép  
RO Capsator pneumatic  
E Engrapadora pneumática

GB Pneumatic nailing machine  
D Druckluftnagelgerät  
PL Gwoździarka pneumatyczna  
RUS Пневматическая гвоздильная машина  
CZ Pneumatický nastřelovač hřebíků  
H Pneumatikus szögbelevő  
RO Capsator pneumatic  
E Máquina pneumática para clavar clavos



BMC  
& COLOR  
SLEEVE

- application: industry, construction
- przeznaczenie: przemysł, budownictwo

|         |   |
|---------|---|
| YT-0920 | 5 |
|---------|---|



BMC  
& COLOR  
SLEEVE

- application: industry, construction
- przeznaczenie: przemysł, budownictwo

|         |   |
|---------|---|
| YT-0921 | 5 |
|---------|---|

GB Pneumatic nailing machine  
 D Druckluftnagelgerät  
 PL Gwoździarka pneumatyczna  
 RUS Пневматическая гвоздильная машина  
 CZ Pneumatický nastřelovač hřebíků  
 H Pneumatikus szögbelevő  
 RO Capsator pneumatic  
 E Maquina pneumática para clavar clavos



GB Pneumatic nailing machine  
 D Druckluftnagelgerät  
 PL Gwoździarka pneumatyczna  
 RUS Пневматическая гвоздильная машина  
 CZ Pneumatický nastřelovač hřebíků  
 H Pneumatikus szögbelevő  
 RO Capsator pneumatic  
 E Maquina pneumática para clavar clavos



BMC & COLOR SLEEVE



\* - product not for european market  
 \* - produkt nieprzeznaczony na rynek europejski

15

- application: industry, construction
- przeznaczenie: przemysł, budownictwo

|          |   |
|----------|---|
| YT-0922* | 5 |
|----------|---|

BMC & COLOR SLEEVE



- application: industry, construction
- przeznaczenie: przemysł, budownictwo

|         |   |
|---------|---|
| YT-0923 | 2 |
|---------|---|

GB Mini palm nailer  
 D Drucklufthammer für Nägel  
 PL Młotek pneumatyczny do gwoździ  
 RUS Пневматический молоток для забивания гвоздей  
 CZ Pneumatická hřebíkovačka  
 H Pneumatikus szögbeütő kalapács  
 RO Ciocan pneumatic pt. cuie  
 E Maquina pneumática para clavar clavos



COLOR BOX



|         |    |
|---------|----|
| YT-0925 | 20 |
|---------|----|

















Memo

# 16

Special automotive tools  
& equipment

Narzędzia i wyposażenie  
warsztatu samochodowego



|  |   |         |  |   |         |
|--|---|---------|--|---|---------|
| <b>Cabinets</b><br>Szafki  |      | 269-273 | <b>Brake system tools</b><br>Narzędzia do obsługi układu hamulcowego                           |    | 309-312 |
| <b>Roller cabinets with tools insert</b><br>Szafki serwisowe z narzędziami               |   | 269     | <b>Suspension system tools</b><br>Narzędzia do obsługi podwozia                                |    | 313-316 |
| <b>Tool cabinets</b><br>Szafki serwisowe   |   | 269     | <b>Spring clamps &amp; accessories</b><br>Ściągacze do sprężyn i akcesoria                     |   | 313     |
| <b>Tools in PVC trays</b><br>Zestawy narzędzi do szuflad                                 |   | 271     | <b>Shock absorber nut sets</b><br>Zestawy nasadek do amortyzatorów                             |   | 314     |
| <b>Accessories for tool cabinets</b><br>Akcesoria do szafek                              |   | 273     | <b>Tire valve stem inserter</b><br>Przeciągacze do zaworów gumowych                            |   | 314     |
| <b>Tool boxes</b><br>Skrzynki narzędziowe  |      | 274-275 | <b>Wheel balance pliers</b><br>Szczypce do wyważania kół                                       |   | 315     |
| <b>Lubrication system tools</b><br>Narzędzia do obsługi układu smarowania                |      | 276-280 | <b>Deep thin wall impact sockets 1/2"</b><br>Udarowe klucze nasadowe 1/2" do felg aluminiowych |   | 315     |
| <b>Oil filter wrenches &amp; sets</b><br>Klucze do filtra oleju i zestawy                |   | 276     | <b>Valve core torque tools</b><br>Klucze dynamometryczne do zaworków gumowych i metalowych     |   | 315     |
| <b>Oil drain plug sockets</b><br>Klucze do spustu oleju                                  |   | 278     | <b>Wheel wrenches</b><br>Klucze do kół   |   | 316     |
| <b>Grease guns &amp; accessories</b><br>Smarownice ręczne i akcesoria                    |   | 279     | <b>Tire levels</b><br>Łyżki do opon  |   | 316     |
| <b>Oil cans</b><br>Oliwiarki   |   | 280     | <b>Workshop tools</b><br>Narzędzia warsztatowe   |    | 316-324 |
| <b>Oil and fuel pumps</b><br>Pompy do oleju oraz paliwa                                  |   | 280     | <b>Flexi shafts</b><br>Wałki giętne  |   | 316     |
| <b>Pullers</b><br>Ściągacze  |    | 281-293 | <b>Inspection tools</b><br>Narzędzia inspekcyjne   |   | 317     |
| <b>Pullers</b><br>Ściągacze  |   | 281     | <b>Magnetic pick up tools</b><br>Chwytki magnetyczne   |   | 319     |
| <b>Roller stud extractor sets</b><br>Zestawy ściągaczy do szpilek                        |   | 286     | <b>Magnetic trays</b><br>Tacki magnetyczne   |   | 319     |
| <b>Upholstery removers</b><br>Ściągacze do tapicerki                                     |   | 293     | <b>Tweezers</b><br>Pęsety  |   | 320     |
| <b>Car window tools</b><br>Narzędzia do szyb samochodowych                               |    | 293-294 | <b>Workshop creepers</b><br>Lezanki warsztatowe  |   | 321     |
| <b>Air condition tools</b><br>Narzędzia do klimatyzacji                                  |    | 294     | <b>Diode workshop lamps</b><br>Diodowe lampy warsztatowe                                       |   | 321     |
| <b>Fuel feel pipe pliers</b><br>Szczypce motoryzacyjne                                   |    | 295-299 | <b>Voltage testers</b><br>Próbniki napięcia  |   | 323     |
| <b>Engine repair tools</b><br>Narzędzia do obsługi silnika                               |    | 299-309 | <b>Number &amp; letter stamps</b><br>Znaczniki cyfrowe i literowe                              |   | 323     |
| <b>Piston ring compressors</b><br>Zaciskacze do pierścieni                               |   | 299     | <b>Thread repair sets &amp; accessories</b><br>Zestawy do naprawy gwintów i akcesoria          |   | 323     |
| <b>Engine repair and diagnostic tools</b><br>Narzędzia do diagnostyki i naprawy silników |   | 300     | <b>Pumps</b><br>Pompki   |   | 324     |
| <b>Spark plug sockets</b><br>Klucze do świec   |   | 308     | <b>Funnels, oil drainer &amp; drainer pans</b><br>Lejki, miski i zlewarki do oleju             |  | 325     |
| <b>Battery chargers &amp; battery testers</b><br>Prostowniki i testery akumulatorów      |  | 328-330 | <b>Bottle &amp; floor jacks</b><br>Dźwigniki słupkowe i podnośniki                             |  | 326-327 |
|  |   |         | <b>Work benches</b><br>Stojaki lakiernicze   |  | 327     |



Chain blocks  
Wciągarki łańcuchowe

331



Hand pullers  
Wciągarki linowe, ręczne

331



Electric hoists  
Elektryczne wciągarki linowe

331



GB Service tool cabinet with tools  
D Serviceschrank mit Werkzeugen  
PL Szafka serwisowa z narzędziami  
RUS Сервисный шкаф с инструментами  
CZ Servisní skříňka s nářadím  
H Szervizszekrény szerszámokkal  
RO Cutie de service cu scule  
E Armario para herramientas de servicio



|  |   |            |  |                             |
|--|---|------------|--|-----------------------------|
| <b>177</b> PCS<br><b>12</b> TRAY<br>WKCAD              | <b>958x766</b><br>x465 mm   | <b>6x</b>  | <b>BALL BEARING</b><br>ŁOŻYSKA KULKOWE | <b>25kg</b><br>35kg<br>35kg |
| <b>DRAWERS LOCKING</b><br>BLOKADA SZUFLAD              | <b>NON SLIP POLYPROPYLENE WORKTOP</b><br>ANTYPRZŚLIZGOWY POLIPROPYLENOWY BLAT | <b>2xT</b> | <b>DOUBLE WALLS</b><br>PODWÓJNE ŚCIANY |                             |
| <b>UNIVERSAL PERFORATION</b><br>UNIWERSALNA PERFORACJA |   |            |  |                             |

**12 interchangeable trays with YATO tools**  
**12 wymiennych modułów z narzędziami YATO**

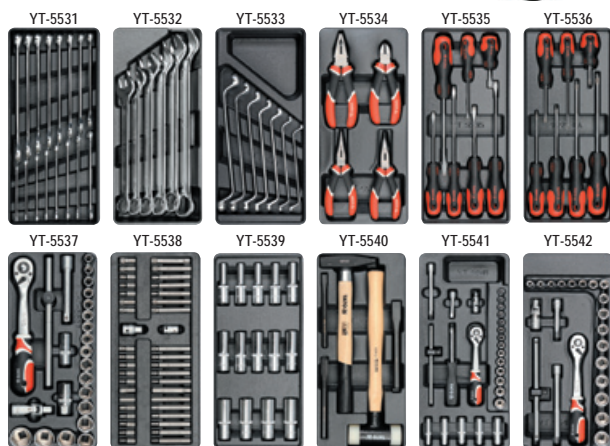

GB Roller cabinet  
D Werkstattrollwagen  
PL Szafka serwisowa  
RUS Инструментальный кабинет  
CZ Dilenská skříňka  
H Görgös szerszámátároló  
RO Dulap de scule  
E Armario en ruedas

|                          |   |   |   |
|--------------------------|---|---|---|
| <b>995x680</b><br>x458mm | <b>4x</b>   | <b>DRAWERS LOCKING</b><br>BLOKADA SZUFLAD     | <b>CENTRAL LOCK</b><br>CENTRALNY ZAMEK                      |
| <b>300kg</b><br>max.     | <b>BALL BEARING</b><br>ŁOŻYSKA KULKOWE  | <b>WHEELS WITH BRAKE</b><br>KÓŁKA Z HAMULCAMI | $\varnothing 5"$ (127 mm)<br>$\leftrightarrow 1"$ (25.4 mm) |
|                          | <b>NON SLIP POLYPROPYLENE WORKTOP</b><br>ANTYPRZŚLIZGOWY POLIPROPYLENOWY BLAT | <b>4xT</b>                                    |   |



|             |                           |   |
|-------------|---------------------------|---|
| <b>YATO</b> | <b>drawers / szuflady</b> |   |
| YT-0912     | 4                         | 1 |

GB Roller cabinet  
D Werkstattrollwagen  
PL Szafka serwisowa  
RUS Инструментальный кабинет  
CZ Dilenská skříňka  
H Görgös szerszámátároló  
RO Dulap de scule  
E Armario en ruedas

|                          |   |   |   |
|--------------------------|---|---|---|
| <b>995x680</b><br>x458mm | <b>6x</b>   | <b>DRAWERS LOCKING</b><br>BLOKADA SZUFLAD     | <b>CENTRAL LOCK</b><br>CENTRALNY ZAMEK                      |
| <b>300kg</b><br>max.     | <b>BALL BEARING</b><br>ŁOŻYSKA KULKOWE  | <b>WHEELS WITH BRAKE</b><br>KÓŁKA Z HAMULCAMI | $\varnothing 5"$ (127 mm)<br>$\leftrightarrow 1"$ (25.4 mm) |
|                          | <b>NON SLIP POLYPROPYLENE WORKTOP</b><br>ANTYPRZŚLIZGOWY POLIPROPYLENOWY BLAT | <b>2xT</b>                                    |   |



|             |                           |   |
|-------------|---------------------------|---|
| <b>YATO</b> | <b>drawers / szuflady</b> |   |
| YT-0913     | 6                         | 1 |

**DRAWER / SZUFLADA 1**

$\varnothing 3/8"$  (9.5 mm): 6, 7, 8, 9, 10, 11, 12, 13, 14, 15, 16, 17, 18, 19, 20, 21, 22 mm; CrV 50BV30;  $\varnothing 3/8"$  (9.5 mm); (76; 152.4 mm); CrV 50BV30;  $\varnothing 3/8"$  (9.5 mm); CrV 50BV30;  $\varnothing 3/8"$  (9.5 mm); (200 mm); 72T; CrV 6140;  $\varnothing 3/8"$  (9.5 mm) x 198 mm; CrV 50BV30;  $\varnothing 1/2"$  (12.7 mm): 10, 11, 12, 13, 14, 15, 16, 17, 18, 19, 20, 21, 22, 23, 24, 27, 30, 32 mm; CrV 50BV30;  $\varnothing 1/2"$  (12.7 mm); CrV 50BV30;  $\varnothing 1/2"$  (12.7 mm); (255 mm); 72T; CrV 6140;  $\varnothing 1/2"$  (12.7 mm) x 255 mm; CrV 50BV30;  $\varnothing 1/2"$  (12.7 mm): 16; 21 mm; CrV 50BV30;  $\varnothing 1/4"$  (6.3 mm): 3.5, 4.0, 4.5, 5.0, 5.5, 6.0, 7.0, 8.0, 9.0, 10.0, 11.0, 12.0, 13.0, 14.0 mm; CrV 50BV30;  $\varnothing 1/4"$  (6.3 mm): 8, 10, 11, 12, 13 mm; CrV 50BV30;  $\varnothing 1/4"$  (6.3 mm); (50.8; 101.6 mm); CrV 6140;  $\varnothing 1/4"$  (6.3 mm); CrV 50BV30;  $\varnothing 1/4"$  (6.3 mm); (155 mm); 72T; CrV 6140;  $\varnothing 1/4"$  (6.3 mm) x 152.4 mm; CrV 50BV30

**DRAWER / SZUFLADA 2**

$\varnothing 3x75$ , 5x100, 5x150, 6x38, 6x100, 6x150, 8x150 mm; CrMo  
PH0x100, PH1x75, PH1x100, PH2x38, PH2x100,  
PH2x150, PH3x150 mm; CrMo  $\varnothing 180$  mm;  $\varnothing 160$  mm;  
 $\varnothing 160$  mm LONG NOSE;  $\varnothing 160$  mm BENT NOSE

**DRAWER / SZUFLADA 3**

$\varnothing 22$ , 24, 27, 28, 30, 32 mm; CrV;  $\varnothing 6$ , 7, 8, 9, 10, 11, 12, 13, 14, 15, 16, 17, 18, 19, 20, 21 mm; CrV;  $\varnothing 1/2"$  (12.7 mm): 8, 9, 10, 11, 12, 13, 14, 15, 16, 17, 18, 19, 20, 21 mm (L=76 mm); CrV 50BV30

**DRAWER / SZUFLADA 4**

$\varnothing 300$  g (L=300 mm);  $\varnothing 40$  mm (L=350 mm);  
10x8x142 mm, 12x10x152 mm, 16x13x172 mm;  $\varnothing$  H4, H5, H6, H7, H8, H10, H12 (L=30 mm); H4, H5, H6, H7, H8, H10, H12 (L=75 mm); AISI S2;  $\varnothing$  M5, M6, M7, M10, M12 (L=30 mm); M5, M6, M7, M10, M12 (L=75 mm); AISI S2; T20, T25, T30, T40, T45, T50, T55 (L=30 mm); T20, T25, T30, T40, T45, T50, T55 (L=75 mm); AISI S2;  $\varnothing 1/2"$  (12.7 mm),  $\varnothing 3/8"$  (9.5 mm);  $\varnothing 6x7$ , 8x9, 10x11, 12x13, 14x15, 16x17, 18x19 mm; CrV

WHITE  
CARTON BOX  
& COLOR LABEL



|             |                           |   |
|-------------|---------------------------|---|
| <b>YATO</b> | <b>drawers / szuflady</b> |   |
| YT-5530     | 6                         | 1 |

GB Roller cabinet  
 D Werkstattrollwagen  
 PL Szafka serwisowa  
 RUS Инструментальный кабинет  
 CZ Dilenská skříňka  
 H Görgös szerszámtároló  
 RO Dulap de scule  
 E Armario en ruedas

995x680 x458mm

7x

DRAWERS LOCKING  
BLOKADA SZUFLAD

CENTRAL LOCK  
CENTRALNY ZAMEK

NON SLIP POLYPROPYLENE WORKTOP  
ANTIPOŚLIZGOWY POLIPROPYLENOWY BLAT

300kg max.

BALL BEARING ŁOŻYSKA KULKOWE

WHEELS WITH BRAKE  
KOLKA Z HAMULCAMI

Ø 5" (127 mm)  
1" (25.4 mm)

2xT



WHITE CARTON BOX & COLOR LABEL



| YATO    | drawers / szuflady |   |
|---------|--------------------|---|
| YT-0914 | 7                  | 1 |

GB Roller cabinet  
 D Werkstattrollwagen  
 PL Szafka serwisowa  
 RUS Инструментальный кабинет  
 CZ Dilenská skříňka  
 H Görgös szerszámtároló  
 RO Dulap de scule  
 E Armario en ruedas

BALL BEARING ŁOŻYSKA KULKOWE

NON SLIP POLYPROPYLENE WORKTOP  
ANTIPOŚLIZGOWY POLIPROPYLENOWY BLAT

UNIVERSAL PERFORATION  
UNIWERSALNA PERFORACJA

DOUBLE WALLS  
PODWÓJNE ŚCIANY

958x766 x465 mm

2xT



WHITE CARTON BOX & COLOR LABEL



| YATO    | drawers / szuflady |   |
|---------|--------------------|---|
| YT-0902 | 6                  | 1 |
| YT-0903 | 7                  | 1 |

GB Roller cabinet  
 D Werkstattrollwagen  
 PL Szafka serwisowa  
 RUS Инструментальный кабинет  
 CZ Dilenská skříňka  
 H Görgös szerszámtároló  
 RO Dulap de scule  
 E Armario en ruedas

958x766 x465 mm

7x

DRAWERS LOCKING  
BLOKADA SZUFLAD

OIL PROOF STEEL WORKTOP  
OLEJODOPORNY STALOWY BLAT

BALL BEARING ŁOŻYSKA KULKOWE

UNIVERSAL PERFORATION  
UNIWERSALNA PERFORACJA

DOUBLE WALLS  
PODWÓJNE ŚCIANY

WHEELS TOLKA



WHITE CARTON BOX & COLOR LABEL



| YATO    | drawers / szuflady |   |
|---------|--------------------|---|
| YT-0904 | 7                  | 1 |

GB Roller cabinet  
 D Werkstattrollwagen  
 PL Szafka serwisowa  
 RUS Инструментальный кабинет  
 CZ Dilenská skříňka  
 H Görgös szerszámtároló  
 RO Dulap de scule  
 E Armario en ruedas

990x750 x450mm

7x

DRAWERS LOCKING  
BLOKADA SZUFLAD

NON SLIP POLYPROPYLENE WORKTOP  
ANTIPOŚLIZGOWY POLIPROPYLENOWY BLAT

BALL BEARING ŁOŻYSKA KULKOWE

UNIVERSAL PERFORATION  
UNIWERSALNA PERFORACJA

DOUBLE WALLS  
PODWÓJNE ŚCIANY

2xT



WHITE CARTON BOX & COLOR LABEL



\* - product not for european market  
 \* - produkt nieprzeznaczony na rynek europejski

| YATO      | drawers / szuflady |   |
|-----------|--------------------|---|
| YT-09140* | 7                  | 1 |

# Special automotive tools & equipment Narzędzia i wyposażenie warsztatu samochodowego



GB Roller cabinet  
D Werkstattrollwagen  
PL Szafka serwisowa  
RUS Инструментальный кабинет  
CZ Dilenská skříňka  
H Görgös szerszámtároló  
RO Dulap de scule  
E Armario en ruedas

1110x1020  
x460mm



\* - product not for european market  
\* - produkt nieprzeznaczony na rynek europejski

WHITE CARTON BOX & COLOR LABEL

|             |                    |   |
|-------------|--------------------|---|
| <b>YATO</b> | drawers / szuflady |   |
| YT-09141*   | 7                  | 1 |

GB Roller cabinet  
D Werkstattrollwagen  
PL Wózek serwisowy  
RUS Инструментальная тележка  
CZ Dilenská skříňka  
H Görgös szerszámtároló  
RO Dulap de scule  
E Carro de taller

958x766  
x465 mm



WHITE CARTON BOX & COLOR LABEL

|             |                    |   |
|-------------|--------------------|---|
| <b>YATO</b> | drawers / szuflady |   |
| YT-0905     | 1                  | 1 |

GB Drawer insert / Combination spanners  
D Schubladeneinlage / Schrauben- und Ringschlüssel  
PL Wkład do szuflady / Klucze płasko-oczkowe  
RUS Вклад к выдвигному ящику / Плоско-закрытый накладной ключ  
CZ Vložka do zásuvky / Klíče ploché-očkové  
H Fiókbetét / Kombinált kulcsok  
RO Adaos la sertar / Chei plane - inelare  
E Accesorio de cajón / Llave española de muletilla

PLASTIC TRAY & COLOR LABEL



6  
PCS

22, 24, 27, 28, 30, 32 mm; CrV

**YATO**  
YT-5532 4



16  
PCS

6, 7, 8, 9, 10, 11, 12, 13, 14, 15, 16, 17, 18, 19, 20, 21 mm; CrV

**YATO**  
YT-5531 8

GB Drawer insert / Bi-hexagonal ring spanner  
D Schubladeneinlage / Doppelringschlüssel  
PL Wkład do szuflady / Klucze oczkowe odgięte  
RUS Вклад к выдвигному ящику / Ключ накладной изогнутый  
CZ Vložka do zásuvky / Klíče očkové ohnuté  
H Fiókbetét / Hajlítottszerű csillagkulcs  
RO Adaos la sertar / Chei inelaro-curbată  
E Accesorio de cajón / Llave de estrella

PLASTIC TRAY & COLOR LABEL

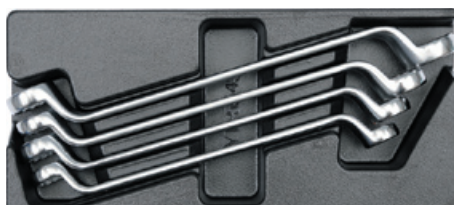

4  
PCS

21x23, 24x27, 25x28, 30x32 mm; CrV

**YATO**  
YT-5543 8



7  
PCS

6x7, 8x9, 10x11, 12x13, 14x15, 16x17, 18x19 mm; CrV

**YATO**  
YT-5533 8

GB Drawer insert / Pliers  
D Schubladeneinlage / Zangen  
PL Wkład do szuflady / Szczypce  
RUS Вклад к выдвигному ящику / Клещи  
CZ Vložka do zásuvky / Kleště  
H Fiókbetét / Fogók  
RO Adaos la sertar / Clește  
E Accesorio de cajón / Pinzas

PLASTIC TRAY & COLOR LABEL

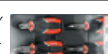

4  
PCS



180 mm;  
160 mm;  
160 mm  
LONG NOSE;  
160 mm  
BENT NOSE

**YATO**  
YT-5534 8

16

**GB** Drawer insert / Slotted screwdrivers  
**D** Schubladeneinlage / Flachschräuber  
**PL** Wkład do szuflady / Wkrętaki płaskie  
**RUS** Вклад к выдвигному ящику / Плоские отвёртки  
**CZ** Vložka do zásuvky / Šroubováky ploché  
**H** Fiókbetét / Lapos csavarhúzó  
**RO** Adaos la sertar / Şurubelnițe plane  
**E** Accesorio de cajón / Desarmadores planos

PLASTIC TRAY & COLOR LABEL



**7**  
PCS  
**CrMo**



3x75, 5x100, 5x150, 6x38, 6x100, 6x150, 8x150 mm; CrMo

**YATO**  
YT-5535 8

**GB** Drawer insert / Phillips screwdrivers  
**D** Schubladeneinlage / Kreuzschlitzschrauber  
**PL** Wkład do szuflady / Wkrętaki krzyżakowe  
**RUS** Вклад к выдвигному ящику / Крестовидные отвёртки  
**CZ** Vložka do zásuvky / Šroubováky křížové  
**H** Fiókbetét / Kereszt csavarhúzó  
**RO** Adaos la sertar / Şurubelnițe în cruce  
**E** Accesorio de cajón / Desarmadores de cruz

PLASTIC TRAY & COLOR LABEL



**7**  
PCS  
**CrMo**

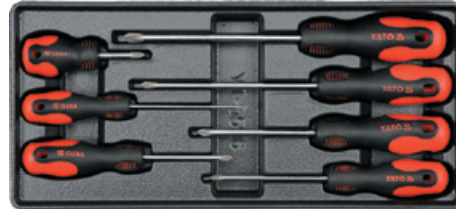

PH0x100, PH1x75, PH1x100, PH2x38, PH2x100, PH2x150, PH3x150 mm; CrMo

**YATO**  
YT-5536 8

**GB** Drawer insert / Socket set  
**D** Schubladeneinlage / Steckschlüsselsatz  
**PL** Wkład do szuflady / Zestaw kluczy nasadowych  
**RUS** Вклад к выдвигному ящику / Торцовые ключи  
**CZ** Vložka do zásuvky / Klíče nástrčné  
**H** Fiókbetét / Dugókulcsok  
**RO** Adaos la sertar / Duză cheie  
**E** Accesorio de cajón / Llaves de cubo

PLASTIC TRAY & COLOR LABEL



**GB** Drawer insert / Socket set  
**D** Schubladeneinlage / Steckschlüsselsatz  
**PL** Wkład do szuflady / Zestaw kluczy nasadowych  
**RUS** Вклад к выдвигному ящику / Торцовые ключи  
**CZ** Vložka do zásuvky / Klíče nástrčné  
**H** Fiókbetét / Dugókulcsok  
**RO** Adaos la sertar / Duză cheie  
**E** Accesorio de cajón / Llaves de cubo

PLASTIC TRAY & COLOR LABEL



**25**  
PCS

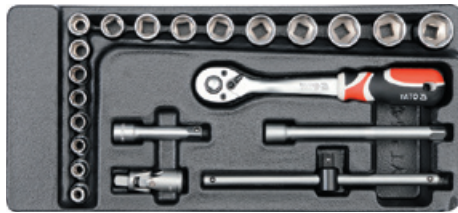

3/8" (9.5 mm): 6, 7, 8, 9, 10, 11, 12, 13, 14, 15, 16, 17, 18, 19, 20, 21, 22 mm; CrV 50BV30;  
 3/8" (9.5 mm): (76; 152.4 mm); CrV 50BV30;  
 3/8" (9.5 mm); CrV 50BV30;  
 3/8" (9.5 mm); (200 mm); 72T; CrV 6140;  
 3/8" (9.5 mm) x 198 mm; CrV 50BV30

**22**  
PCS

**YATO**  
YT-5542 8

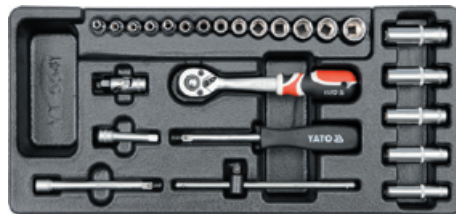

1/4" (6.3 mm): 3.5, 4.0, 4.5, 5.0, 5.5, 6.0, 7.0, 8.0, 9.0, 10.0, 11.0, 12.0, 13.0, 14.0 mm; CrV 50BV30;  
 1/4" (6.3 mm): 8, 10, 11, 12, 13 mm; CrV 50BV30;  
 1/4" (6.3 mm): (50.8; 101.6 mm); CrV 6140;  
 1/4" (6.3 mm); CrV 50BV30;  
 1/4" (6.3 mm); (155 mm); 72T; CrV 6140;  
 1/4" (6.3 mm) x 152.4 mm; CrV 50BV30

**YATO**  
YT-5541 8



1/2" (12.7 mm): 10, 11, 12, 13, 14, 15, 16, 17, 18, 19, 20, 21, 22, 23, 24, 27, 30, 32 mm; CrV 50BV30;  
 1/2" (12.7 mm); CrV 50BV30;  
 1/2" (12.7 mm); CrV 50BV30;  
 1/2" (12.7 mm); (255 mm); 72T; CrV 6140;  
 1/2" (12.7 mm) x 255 mm; CrV 50BV30;  
 1/2" (12.7 mm): 16; 21 mm; CrV 50BV30

**24**  
PCS

**YATO**  
YT-5537 4

**GB** Drawer insert / Screwdriver bits  
**D** Schubladeneinlage / Endstücke für Schraubenzieher  
**PL** Wkład do szuflady / Końcówki śrubokrętowe  
**RUS** Вклад к выдвигному ящику / Насадки для отвёрток  
**CZ** Vložka do zásuvky / Šroubovací nástavce  
**H** Fiókbetét / Csavarhúzó bitek  
**RO** Adaos la sertar / Terminații pt. şurubelnițe  
**E** Accesorio de cajón / Puntas para desarmadores

PLASTIC TRAY & COLOR LABEL



**40**  
PCS



H4, H5, H6, H7, H8, H10, H12 (L=30 mm); H4, H5, H6, H7, H8, H10, H12 (L=75 mm); AISI S2; M5, M6, M7, M10, M12 (L=30 mm); M5, M6, M7, M10, M12 (L=75 mm); AISI S2; T20, T25, T30, T40, T45, T50, T55 (L=30 mm); T20, T25, T30, T40, T45, T50, T55 (L=75 mm); AISI S2; 1/2" (12.7 mm), 3/8" (9.5 mm)

**YATO**  
YT-5538 8

**GB** Drawer insert / Deep sockets  
**D** Schubladeneinlage / Tiefe Steckschlüssel  
**PL** Wkład do szuflady / Klucze nasadowe długie  
**RUS** Вклад к выдвигному ящику / Торцовые глубокие ключи  
**CZ** Vložka do zásuvky / Klíče nástrčné hluboké  
**H** Fiókbetét / Mély dugókulcsok  
**RO** Adaos la sertar / Prize de curent adânci  
**E** Accesorio de cajón / Llaves de cubo profundo

PLASTIC TRAY & COLOR LABEL



**14**  
PCS  
**CrV 50BV30**



1/2" (12.7 mm): 8, 9, 10, 11, 12, 13, 14, 15, 16, 17, 18, 19, 20, 21 mm (L=76 mm); CrV 50BV30

**YATO**  
YT-5539 8

**GB** Drawer insert / Hammers and chisels  
**D** Schubladeneinlage / Hämmer und Meißel  
**PL** Wkład do szuflady / Młotki i przecinaki  
**RUS** Вклад к выдвигному ящику / Молотки и зубила  
**CZ** Vložka do zásuvky / Kladiva, dláta a sekáče  
**H** Fiókbetét / Kalapácsok és hidegvágók  
**RO** Adaos la sertar / Ciocane și dălți  
**E** Accesorio de cajón / Martillos y cinceles

PLASTIC TRAY & COLOR LABEL



**5**  
PCS  
**CrV**



300 g (L=300 mm); 40 mm (L=350 mm); 10x8x142 mm, 12x10x152 mm, 16x13x172 mm

**YATO**  
YT-5540 8



GB Drawer insert  
D Schubladeneinlage  
PL Wkład do szuflady  
RUS Вклад к выдвижному ящику  
CZ Vložka do zásuvky  
H Fiókbetét  
RO Adaos la sertar  
E Accesorio de cajón



for / dla:  
YT-5531

|             |  |      |
|-------------|--|------|
| <b>YATO</b> |  | 5/30 |
| YT-55311    |  |      |



for / dla:  
YT-5532

|             |  |      |
|-------------|--|------|
| <b>YATO</b> |  | 5/30 |
| YT-55321    |  |      |



for / dla:  
YT-5533

|             |  |      |
|-------------|--|------|
| <b>YATO</b> |  | 5/30 |
| YT-55331    |  |      |

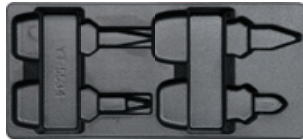

for / dla:  
YT-5534

|             |  |      |
|-------------|--|------|
| <b>YATO</b> |  | 5/30 |
| YT-55341    |  |      |

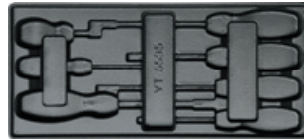

for / dla:  
YT-5535

|             |  |      |
|-------------|--|------|
| <b>YATO</b> |  | 5/30 |
| YT-55351    |  |      |

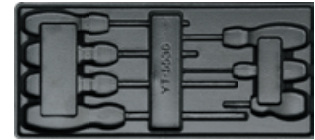

for / dla:  
YT-5536

|             |  |      |
|-------------|--|------|
| <b>YATO</b> |  | 5/30 |
| YT-55361    |  |      |

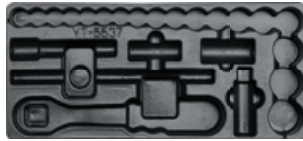

for / dla:  
YT-5537

|             |  |      |
|-------------|--|------|
| <b>YATO</b> |  | 5/30 |
| YT-55371    |  |      |

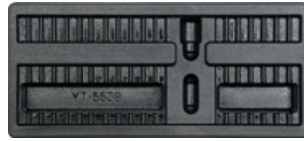

for / dla:  
YT-5538

|             |  |      |
|-------------|--|------|
| <b>YATO</b> |  | 5/30 |
| YT-55381    |  |      |



for / dla:  
YT-5539

|             |  |      |
|-------------|--|------|
| <b>YATO</b> |  | 5/30 |
| YT-55391    |  |      |



for / dla:  
YT-5540

|             |  |      |
|-------------|--|------|
| <b>YATO</b> |  | 5/30 |
| YT-55401    |  |      |

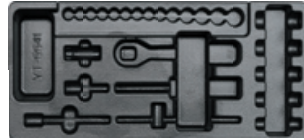

for / dla:  
YT-5541

|             |  |      |
|-------------|--|------|
| <b>YATO</b> |  | 5/30 |
| YT-55411    |  |      |

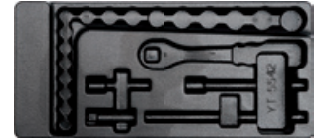

for / dla:  
YT-5542

|             |  |      |
|-------------|--|------|
| <b>YATO</b> |  | 5/30 |
| YT-55421    |  |      |

GB Compartmented shelf  
and paper roll holder  
D Werkstattwagenab-lage  
mit Papierrollehalter  
PL Półka z uchwytem  
na papier  
RUS Полка с держателем  
для бумаги  
CZ Police s úchytem na papír  
H Kiegészítő polc és papírrolni  
tartó funkcióval  
RO Compartiment pt. dulap  
si suport hartie  
E Estante con sujetapapel



for / dla: YT-0902, YT-0903, YT-0904, YT-0905

|             |                     |   |
|-------------|---------------------|---|
| <b>YATO</b> | size / rozmiar (mm) |   |
| YT-0907     | 305x305x145         | 4 |

GB Dustbin  
D Abfalleimer  
PL Pojemnik na odpady  
RUS Мусорный ящик  
CZ Zásobník na odpad  
H Szemetkosár  
RO Lada de gunoi  
E Cubo de basura



for / dla: YT-0902, YT-0903, YT-0904, YT-0905

|             |                     |   |
|-------------|---------------------|---|
| <b>YATO</b> | size / rozmiar (mm) |   |
| YT-0908     | 300x300x190         | 4 |

GB Bottle holder  
D Flaschenhalter  
PL Pojemnik na butelki  
RUS Контейнер для  
бутылок  
CZ Zásobník na nápoje  
H Flakon tartó  
RO Suport pt. sticle  
E Soporte  
para botellas



for / dla: YT-0902, YT-0903, YT-0904, YT-0905

|             |                     |   |
|-------------|---------------------|---|
| <b>YATO</b> | size / rozmiar (mm) |   |
| YT-0909     | 250x110x80          | 6 |

GB Separate board for drawer  
D Trennsteg für Werkstatt-  
Wagen-Schublade  
PL Przegroda do szafki  
RUS Перегородки для ящика  
CZ Půhřádka do police  
H Több rekeszes tábla  
RO Sertar separat  
de masura mica  
E Separador  
para armario



for / dla: YT-0902, YT-0903, YT-0904, YT-0905

|             |                     |    |
|-------------|---------------------|----|
| <b>YATO</b> | size / rozmiar (mm) |    |
| YT-0910     | 391x58x4            | 24 |
| YT-0911     | 391x128x4           | 12 |

GB Cantilever tool box  
 D Werkzeugkoffer  
 PL Skrzynka narzędziowa  
 RUS Инструментальный ящик  
 CZ Nástrojová skříňka  
 H Szerszámoszláda  
 RO Cutie pt. scule  
 E Caja de herramientas



WHITE  
 CARTON  
 BOX  
 & COLOR  
 LABEL



\* - product not for european market  
 \* - produkt nieprzeznaczony na rynek europejski

| YATO     | size / rozmiar (mm) |   |
|----------|---------------------|---|
| YT-0881* | 495x290x200         | 1 |

GB Cantilever tool box  
 D Werkzeugkoffer  
 PL Skrzynka narzędziowa  
 RUS Инструментальный ящик  
 CZ Nástrojová skříňka  
 H Szerszámoszláda  
 RO Cutie pt. scule  
 E Caja de herramientas

WHITE  
 CARTON  
 BOX  
 & COLOR  
 LABEL



| YATO    | size / rozmiar (mm) |   |
|---------|---------------------|---|
| YT-0882 | 360x150x115         | 4 |

| YATO    | size / rozmiar (mm) |   |
|---------|---------------------|---|
| YT-0883 | 428x180x180         | 1 |



| YATO    | size / rozmiar (mm) |   |
|---------|---------------------|---|
| YT-0884 | 460x200x180         | 1 |

| YATO    | size / rozmiar (mm) |   |
|---------|---------------------|---|
| YT-0885 | 460x200x225         | 1 |

| YATO    | size / rozmiar (mm) |   |
|---------|---------------------|---|
| YT-0886 | 510x220x240         | 1 |

GB Cantilever tool box  
 D Werkzeugkoffer  
 PL Skrzynka narzędziowa  
 RUS Инструментальный ящик  
 CZ Nástrojová skříňka  
 H Szerszámoszláda  
 RO Cutie pt. scule  
 E Caja de herramientas



WHITE  
 CARTON  
 BOX  
 & COLOR  
 LABEL



\* - product not for european market  
 \* - produkt nieprzeznaczony na rynek europejski

| YATO     | size / rozmiar (mm) |   |
|----------|---------------------|---|
| YT-0887* | 475x230x365         | 1 |

GB Tool box with tools  
 D Werkzeugkoffer  
 PL Skrzynka z narzędziami  
 RUS Инструментальный ящик  
 CZ Nástrojová skříňka  
 H Szerszámoszláda  
 RO Cutie pt. scule  
 E Caja de herramientas



|           |            |             |             |               |
|-----------|------------|-------------|-------------|---------------|
| 62<br>PCS | 1/2"       | CrV<br>6140 | CrV<br>6150 | CrV<br>50BV30 |
| 72T       | 12.5<br>mm | AS-DRIVE    | ⊖           | ⊕             |

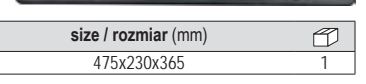

- 1/2" (12.7 mm): 10, 11, 12, 13, 14, 15, 16, 17, 18, 19, 20, 21, 22, 23, 24 mm (L=38 mm); 27, 30, 32 mm (L=42 mm); CrV 50BV30;
- 1/2" (12.7 mm): 21 mm; CrV 50BV30;
- 1/2" (12.7 mm); CrV 50BV30;
- 1/2" (12.7 mm); (76, 127, 254 mm); CrV 50BV30;
- 1/2" (12.7 mm); (255 mm); CrV 50BV30;
- 1/2" (12.7 mm); (450 mm); CrV 50BV30;
- 1/2" (12.7 mm); 72T; CrV 6140;
- 1.5, 2, 2.5, 3, 4, 5, 6, 8, 10 mm; CrV 6150;
- 180 mm; CrV; 160 mm; CrV; 160 mm; CrV;
- 6x100, 6x150, 8x200 mm, CrV 6150;
- PH2x100, PH3x150, PH3x200 mm, CrV 6150;
- 6, 7, 8, 9, 10, 11, 12, 13, 14, 15, 16, 17, 18, 19, 20, 21, 22, 24 mm

| YATO    | size / rozmiar (mm) |   |
|---------|---------------------|---|
| YT-3895 | 475x230x365         | 1 |

- GB Tool box with tools  
D Werkzeugkoffer  
PL Skrzynka z narzędziami  
RUS Инструментальный ящик  
CZ Nástrojová skříňka  
H Szerszámoszláda  
RO Cutie pt. scule  
E Caja de herramientas



|           |            |           |               |          |
|-----------|------------|-----------|---------------|----------|
| 80<br>PCS | 1/2"       | 1/4"      | CrV<br>6140   | ⊖        |
|           | 12.5<br>mm | 6.3<br>mm | CrV<br>50BV30 | ⊕        |
|           |            |           | S2            | 72T      |
|           |            |           |               | AS-DRIVE |



- 1/2" (12.7 mm): 10, 11, 12, 13, 14, 15, 17, 19 mm (L=38 mm);  
 1/4" (6.3 mm): 5, 6, 7, 8, 9, 10, 11, 12, 13 mm (L=25 mm); CrV 50BV30;  
 1/2" (12.7 mm): 21 mm; CrV 50BV30;  
 1/2" (12.7 mm): (255 mm); 72T; CrV 6140;  
 1/4" (6.3 mm): (150 mm); CrV 50BV30;  
 1/4" (6.3 mm) x 1/4" (6.3 mm); CrV 50BV30;  
 1/4" (6.3 mm): 3 (x2), 4 (x2), 5 (x2), 5.5 (x2), 6 (x2) mm (L=25 mm); AISI S2;  
 1/4" (6.3 mm): PH0, PH1 (x2), PH2 (x2), PH3 (L=25 mm); AISI S2;  
 1/4" (6.3 mm): PZ0, PZ1 (x2), PZ2 (L=25 mm); AISI S2;  
 6, 7, 8, 9, 10, 11, 12, 13, 14, 15, 17, 19 mm; CrV;  
 5x75 mm, 6x100 mm, 8x150 mm, PH1x75 mm, PH2x100 mm; S2;  
 1.5, 2, 2.5, 3, 4, 5, 5.5, 6 mm; T10, T15, T20, T25, T27, T30, T40; CrV  
 180 mm; CrV; 160 mm; CrV; 160 mm; CrV;  
 250 mm; 300 g; 18 mm; SK2; 18x0.5 mm; SK2

WHITE CARTON BOX  
& COLOR LABEL



| YATO     | size / rozmiar (mm) |   |
|----------|---------------------|---|
| YT-38951 | 460x220x245         | 1 |

- GB Cantilever tool box  
D Werkzeugkoffer  
PL Skrzynka narzędziowa  
RUS Инструментальный ящик  
CZ Nástrojová skříňka  
H Szerszámoszláda  
RO Cutie pt. scule  
E Caja de herramientas



WHITE CARTON BOX  
& COLOR LABEL



| YATO      | size / rozmiar (mm) | max. load / max. obciążenie (kg) | max. capacity / max. ładunek (kg) |    |
|-----------|---------------------|----------------------------------|-----------------------------------|----|
| YT-08880* | 350x180x160         | 50                               | 10                                | 12 |
| YT-08881* | 420x210x195         | 50                               | 15                                | 9  |
| YT-08882* | 475x230x210         | 50                               | 15                                | 6  |

\* - product not for european market  
\* - produkt nieprzeznaczony na rynek europejski

PP 16

- GB Oil filter wrench
- D Ölfilterschlüssel
- PL Klucz do filtra oleju
- RUS Ключ к масляному фильтру
- CZ Klíč na olejový filtr
- H Olajszűrő kulcs
- RO Cheie pt. filtrul de ulei
- E Llave para el filtro de aceite

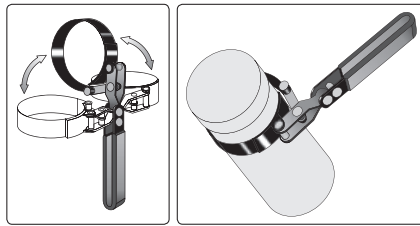

SLIDING CARD

| YATO    | Ø (mm) |       |
|---------|--------|-------|
| YT-0820 | 60-73  | 12/48 |
| YT-0821 | 73-85  | 12/48 |
| YT-0822 | 85-95  | 12/48 |
| YT-0823 | 95-111 | 12/48 |

- GB Cap type oil filter wrench set
- D Steckschlüsselsatz für den Ölfilter
- PL Zestaw kluczy nasadowych do filtra oleju
- RUS Набор торцовых ключей к масляному фильтру
- CZ Sada miskovitých klíčů na olejové filtry
- H Dugókulcs készlet olajszűrőhöz
- RO Set de chei tubulare pt. filtru de ulei
- E Juego de llaves de tubo para el filtro de aceite

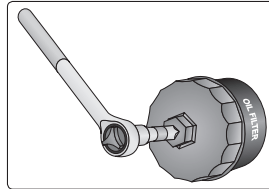

- 13 PCS
- 3/8"
- 10 mm
- 1/2"
- 12.5 mm
- 65-120 mm



BMC & COLOR SLEEVE

| YATO    | number | size    | layers  | grooves | faces                                    | car models                                      |   |
|---------|--------|---------|---------|---------|--|---|---|
|         |        | rozmiar | warstwy | brzozy  | powierzchnie                             | modele samochodow                               |   |
| YT-0594 | 66/6   | SW66    | 1       | 6       |  | Fiat Punto 1.2, Renault Clio 1.2, Rapid, Twingo | 5 |
|         | 76/8   | SW76    | 1       | 8       |  | Fiat, Lancia                                    |   |
|         | 76/12  | SW76    | 1       | 12      |  | Fiat, Mercedes, Renault                         |   |
|         | 86/16  | SW86    | 1       | 16      |  | Volvo   |   |
|         | 86/18  | SW86    | 1       | 18      |  | VW Golf, Audi A6 TDI, Peugeot, Citroen          |   |
|         | 92/10  | SW92    | 1       | 10      |  | Fiat  |   |
|         | 93/45  | SW93    | 1       | 45      |  | VW, Audi TDI                                    |   |
|         | 96/18  | SW96    | 1       | 18      |  | Audi A4, A6 TDI, VQ Passat TDI, Renault Laguna  |   |
|         | 106/15 | SW106   | 1       | 15      |  | Fiat Ducato                                     |   |
|         | 108/15 | SW108   | 1       | 15      |  | Volvo   |   |
| 108/18  | SW108  | 1       | 18      |         | Renault Espace, Laguna, Safrane, Traffic |   |   |

- GB Belt oil wrench
- D Ölfilterschlüssel mit Riemen
- PL Klucz taśmowy do filtrów oleju
- RUS Ключ тросовый для масляных фильтров
- CZ Klíč na olejové filtry
- H Olajszűrő kulcs
- RO Cheie filtru cu banda
- E Llave de cinta para filtros de aceite

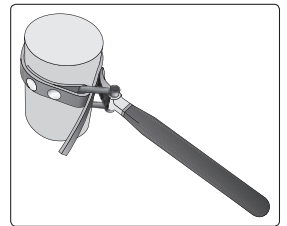

BLISTER CARD

| YATO    | Ø (mm)  |      |
|---------|---------|------|
| YT-0824 | 80-160  | 6/60 |
| YT-0825 | 100-200 | 5/20 |

- GB Oil filter wrench
- D Ölfilterschlüssel
- PL Klucz do filtra oleju
- RUS Съёмник масляных фильтров
- CZ Klíč na filtr oleju řetězový
- H Olajszűrő kulcs, láncos
- RO Cheie filtru ulei cu lanț
- E Llave do filtro de cadenta



- 63-120 mm
- 3/8"
- 10.0 mm
- 12.5 mm
- HRC 40-50
- CrV

COLOR BOX

| YATO    |  |       |
|---------|--|-------|
| YT-0826 |  | 12/36 |

- GB Cap type oil filter wrench set
- D Steckschlüsselsatz für den Ölfilter
- PL Zestaw kluczy nasadowych do filtra oleju
- RUS Набор торцовых ключей к масляному фильтру
- CZ Sada miskovitých klíčů na olejové filtry
- H Dugókulcs készlet olajszűrőhöz
- RO Set de chei tubulare pt. filtru de ulei
- E Juego de llaves de tubo para el filtro de aceite

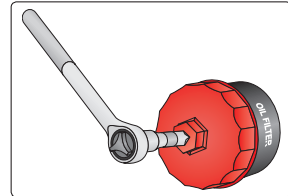

- 15 PCS
- FIBRE REINFORCED POLYMER
- 3/8"
- 10 mm



BMC & COLOR SLEEVE

- 93/15F, 93/36F, 90/15F,
- 82/15F, 80/15F, 76/14F,
- 74/15F, 74/76/15F, 73/14F,
- 68/14F, 65/67/14F

| YATO    | Ø             |   |
|---------|---------------|---|
| YT-0595 | 3/8" (9.5 mm) | 5 |

GB Cap type oil filter wrench set  
D Steckschlüsselsatz für den Ölfilter  
PL Zestaw kluczy nasadowych do filtra oleju  
RUS Набор торцовых ключей к масляному фильтру

CZ Sada miskovitých klíčů na olejové filtry  
H Dugókulcs készlet olajsűrűhöz  
RO Set de chei tubulare pt. filtru de ulei  
E Juego de llaves de tubo para el filtro de aceite

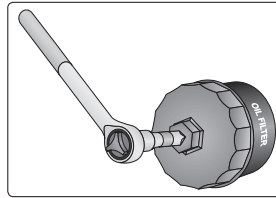

30 PCS  
3/8"  
10 mm



| YATO   | number number | size rozmiar | layers warstwy | grooves bruzdy | faces powierzchnie | car models modele samochodů                     |
|--------|---------------|--------------|----------------|----------------|--------------------|---|
| 66/6   | SW66          | 1            | 6              |                |                    | Fiat Punto 1.2, Renault Clio 1.2, Rapid, Twingo |
| 65/14  | SW65          | 1            |                |                | 14                 | Daihatsu, Toyota, Nissan, Fiat                  |
| 65/67  | SW65-67       | 1            |                |                | 14                 | Daihatsu, Toyota                                |
| 68/14  | SW68          | 1            |                |                | 14                 | Mazda, Ford, Subaru                             |
| 73/14  | SW73          | 1            |                |                | 14                 | Toyota, Lexus                                   |
| 74/15  | SW74          | 1            |                |                | 15                 | Audi, Rover, Chrysler                           |
| 74/76  | SW74-76       | 2            |                |                | 15                 | Ford, Opel, VW, Audi, Mercedes                  |
| 75/77  | SW75-77       | 2            |                |                | 15                 | VW, Audi, Isuzu, Mercedes                       |
| 76/12  | SW76          | 1            |                |                | 12                 | Fiat, Mercedes, Renault                         |
| 76/14  | SW76          | 1            |                |                | 14                 | VW, Porsche, Mercedes, BMW, Audi, Opel          |
| 76/30  | SW76          | 1            | 30             |                |                    | Ford  |
| 76/8   | SW76          | 1            | 8              |                |                    | Fiat, Lancia                                    |
| 78/15  | SW78          | 1            |                |                | 15                 | Nissan, Ford, Toyota                            |
| 80/15  | SW80          | 1            |                |                | 15                 | Nissan, Honda, Opel, Mazda                      |
| 80/82  | SW80-82       | 2            |                |                | 15                 | Subaru, Toyota, Honda, Nissan                   |
| 86/16  | SW86          | 1            |                |                | 16                 | Volvo   |
| 86/18  | SW86          | 1            |                |                | 18                 | VW Golf, Audi A6 TDI, Peugeot, Citroen          |
| 90/15  | SW90          | 1            |                |                | 15                 | Honda, Mitsubishi, Isuzu                        |
| 92/10  | SW92          | 1            |                |                | 10                 | Fiat  |
| 93/15  | SW93          | 1            |                |                | 15                 | Mazda, Volvo, Mitsubishi, Nissan, Honda         |
| 93/36  | SW93          | 1            | 36             |                |                    | Ford  |
| 93/45  | SW93          | 1            | 45             |                |                    | VW, Audi TDI                                    |
| 95/15  | SW95          | 1            | 15             |                |                    | Toyota, Alfa Romeo, Ford                        |
| 96/18  | SW96          | 1            | 18             |                |                    | Audi A4, A6 TDI, VQ Passat TDI, Renault Laguna  |
| 100/15 | SW100         | 1            |                |                | 15                 | Isuzu, Mitsubishi                               |
| 106/15 | SW106         | 1            |                |                | 15                 | Fiat Ducato                                     |
| 108/15 | SW108         | 1            |                |                | 15                 | Volvo   |
| 108/18 | SW108         | 1            | 18             |                |                    | Renault Espace, Laguna, Safrane, Traffic        |

YT-0596

3

GB Cap type oil filter wrench set  
D Steckschlüsselsatz für den Ölfilter  
PL Zestaw kluczy nasadowych do filtra oleju  
RUS Набор торцовых ключей к масляному фильтру

CZ Sada miskovitých klíčů na olejové filtry  
H Dugókulcs készlet olajsűrűhöz  
RO Set de chei tubulare pt. filtru de ulei  
E Juego de llaves de tubo para el filtro de aceite

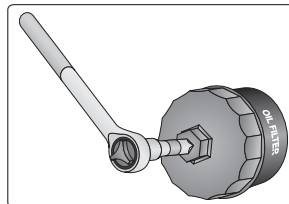

30 PCS  
CrV 50BV30  
3/8"  
CrMo SCM-440  
10 mm



| YATO   | number number | size rozmiar | layers warstwy | grooves bruzdy | faces powierzchnie | car models modele samochodů                     |
|--------|---------------|--------------|----------------|----------------|--------------------|---|
| 66/6   | SW66          | 1            | 6              |                |                    | Fiat Punto 1.2, Renault Clio 1.2, Rapid, Twingo |
| 65/14  | SW65          | 1            |                |                | 14                 | Daihatsu, Toyota, Nissan, Fiat                  |
| 65/67  | SW65-67       | 1            |                |                | 14                 | Daihatsu, Toyota                                |
| 68/14  | SW68          | 1            |                |                | 14                 | Mazda, Ford, Subaru                             |
| 73/14  | SW73          | 1            |                |                | 14                 | Toyota, Lexus                                   |
| 74/15  | SW74          | 1            |                |                | 15                 | Audi, Rover, Chrysler                           |
| 74/76  | SW74-76       | 2            |                |                | 15                 | Ford, Opel, VW, Audi, Mercedes                  |
| 75/77  | SW75-77       | 2            |                |                | 15                 | VW, Audi, Isuzu, Mercedes                       |
| 76/12  | SW76          | 1            |                |                | 12                 | Fiat, Mercedes, Renault                         |
| 76/14  | SW76          | 1            |                |                | 14                 | VW, Porsche, Mercedes, BMW, Audi, Opel          |
| 76/30  | SW76          | 1            | 30             |                |                    | Ford  |
| 76/8   | SW76          | 1            | 8              |                |                    | Fiat, Lancia                                    |
| 78/15  | SW78          | 1            |                |                | 15                 | Nissan, Ford, Toyota                            |
| 80/15  | SW80          | 1            |                |                | 15                 | Nissan, Honda, Opel, Mazda                      |
| 80/82  | SW80-82       | 2            |                |                | 15                 | Subaru, Toyota, Honda, Nissan                   |
| 86/16  | SW86          | 1            |                |                | 16                 | Volvo   |
| 86/18  | SW86          | 1            |                |                | 18                 | VW Golf, Audi A6 TDI, Peugeot, Citroen          |
| 90/15  | SW90          | 1            |                |                | 15                 | Honda, Mitsubishi, Isuzu                        |
| 92/10  | SW92          | 1            |                |                | 10                 | Fiat  |
| 93/15  | SW93          | 1            |                |                | 15                 | Mazda, Volvo, Mitsubishi, Nissan, Honda         |
| 93/36  | SW93          | 1            | 36             |                |                    | Ford  |
| 93/45  | SW93          | 1            | 45             |                |                    | VW, Audi TDI                                    |
| 95/15  | SW95          | 1            | 15             |                |                    | Toyota, Alfa Romeo, Ford                        |
| 96/18  | SW96          | 1            | 18             |                |                    | Audi A4, A6 TDI, VQ Passat TDI, Renault Laguna  |
| 100/15 | SW100         | 1            |                |                | 15                 | Isuzu, Mitsubishi                               |
| 106/15 | SW106         | 1            |                |                | 15                 | Fiat Ducato                                     |
| 108/15 | SW108         | 1            |                |                | 15                 | Volvo   |
| 108/18 | SW108         | 1            | 18             |                |                    | Renault Espace, Laguna, Safrane, Traffic        |

YT-0597

3

- GB Oil filter sockets
- D Aufsätze für die Ölfilter
- PL Zestaw nasadek do filtrów oleju
- RUS Набор насадок к масляным фильтрам
- CZ Sada nástavců na olejové filtry
- H Olajsűrítő leszedő készlet
- RO Set de cartușe pt. filtre de ulei
- E Juego de tapones para los filtros de aceite



|          |      |          |     |
|----------|------|----------|-----|
| 4<br>PCS | 3/8" | AS-DRIVE | CrV |
| 10<br>mm |      |          |     |

BMC & COLOR SLEEVE



|             |               |    |
|-------------|---------------|----|
| <b>YATO</b> |               |    |
| YT-0598     | 3/8" (9.5 mm) | 20 |

- GB Oil drain plug set
- D Olablassschrauben Schlüsselsatz
- PL Komplet kluczy do korków oleju
- RUS Комплект ключей для сливной пробки
- CZ Klíče nástrčné na zátky olejových van motorů
- H Olajleeresztő kulcs készlet
- RO Set bituri pt. bujon ulei
- E Juego de llaves para tapones de aceite

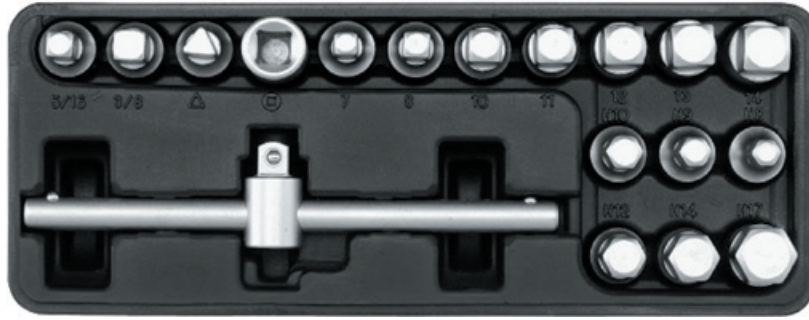

|           |      |          |     |
|-----------|------|----------|-----|
| 18<br>PCS | 3/8" | 10<br>mm | CrV |
|           |      |          |     |
|           |      |          |     |

BMC & COLOR SLEEVE



|             |               |    |
|-------------|---------------|----|
| <b>YATO</b> |               |    |
| YT-0599     | 3/8" (9.5 mm) | 10 |

- 7, 8, 10, 11, 12, 13, 14 mm; 8, 9, 10, 12, 14, 17 mm;
- 5/16" (8 mm), 3/8" (10 mm); 10 mm; 10 mm; 160 mm

- GB Oil drain plug set
- D Olablassschrauben Schlüsselsatz
- PL Komplet kluczy do korków oleju
- RUS Комплект ключей для сливной пробки
- CZ Klíče nástrčné na zátky olejových van motorů
- H Olajleeresztő kulcskészlet
- RO Set bituri pt. bujon ulei
- E Juego de llaves para tapones de aceite



|           |      |                         |
|-----------|------|-------------------------|
| 12<br>PCS | 3/8" | (mm)<br>8 11 13         |
|           |      | (mm)<br>8 9 10 12 14 17 |

SLIDING CARD



|             |  |       |
|-------------|--|-------|
| <b>YATO</b> |  |       |
| YT-0600     |  | 10/20 |

- GB Oil pan thread repair set
- D Reparatursatz für Verschlussstopfen von Ölwanen
- PL Zestaw naprawczy korków do miski olejowej
- RUS Набор для ремонта масляных пробок
- CZ Souprava na opravi vupouštěcích šroubů olejových van
- H Olajteknő-csavar javítókészlet
- RO Set pt. reparare dopuri baie de ulei
- E Juego de reparación para los tapones del cárter de aceite



|           |      |
|-----------|------|
| 64<br>PCS | CrMo |
|-----------|------|

BMC & COLOR SLEEVE



|             |  |    |
|-------------|--|----|
| <b>YATO</b> |  |    |
| YT-1757     |  | 10 |

- M13 5 pcs 13 mm 10 pcs
- M15 5 pcs 15 mm 10 pcs
- M17 5 pcs 17 mm 10 pcs
- M20 5 pcs 20 mm 10 pcs

Special automotive tools & equipment  
Narzędzia i wyposażenie warsztatu samochodowego

**YATO**

GB Lever action grease gun with rigid spout  
D Handhebel-Fettpresse  
PL Smarownica ręczna z końcówką sztywną

RUS Шприц для масляной смазки с твердым  
наконечником и гибким шлангом  
CZ Páková maznice s pevnou koncovkou

H Karos zsírzó  
RO Masina de gresat cu furton rigid  
E Pistola de engrase

COLOR BOX



P<sub>max.</sub>  
**70** MPa

P  
**31** MPa

**Al**

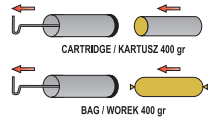

**500**  
cm<sup>3</sup>

**YATO**  
YT-0700

20

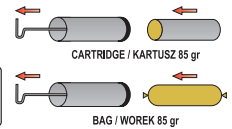

**120**  
cm<sup>3</sup>

**YATO**  
YT-0701

30



**400**  
cm<sup>3</sup>

**YATO**  
YT-0705

20

GB Grease gun  
D Handhebel-Fettpresse  
PL Smarownica ręczna  
RUS Шприц для масляной смазки

CZ Páková maznice  
H Karos zsírzó  
RO Masina de gresat cu furton rigid  
E Pistola de engrase

COLOR BOX



P<sub>(MPa)</sub>  
**27-41**

**Al**



**600**  
cm<sup>3</sup>

**YATO**  
YT-07042

6/12



**800**  
cm<sup>3</sup>

**YATO**  
YT-07043

4/8

GB Two-way operation grease gun  
 D Handhebel-Fettpresse  
 PL Smarownica ręczna, wzmacniona  
 RUS Шприц для масляной смазки

CZ Páková maznice  
 H Karos zsírzó  
 RO Masina de gresat cu furturn rigid  
 E Pistola de engrase

500 cm<sup>3</sup> P max. 70 MPa AI P 42 MPa

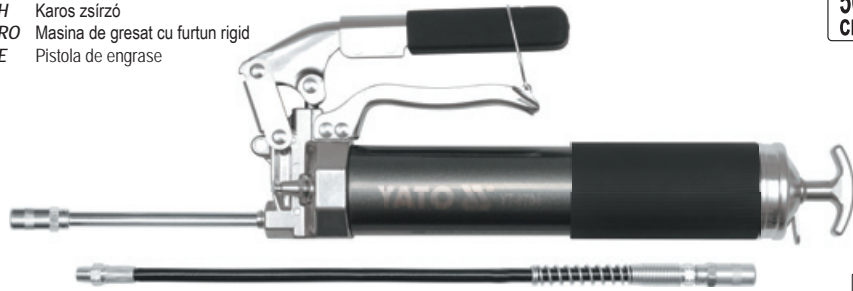
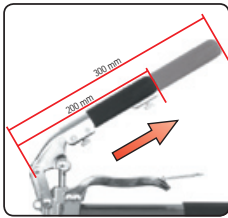

YATO  
 YT-0704 12



HIGH PRESSURE  
 69 MPa  
 LOW VOLUME  
 14 g / 40 STROKE



WYSOKIE CIŚNIENIE  
 69 MPa  
 NISKA WYDAJNOŚĆ  
 14 g / 40 CYKLI

LOW PRESSURE  
 6.9 MPa  
 HIGH VOLUME  
 100 g / 40 STROKE

NISKIE CIŚNIENIE  
 6.9 MPa  
 WYSOKA WYDAJNOŚĆ  
 100 g / 40 CYKLI



500 cm<sup>3</sup>  
 CARTRIDGE / KARTUSZ 85 gr  
 BAG / WOREK 85 gr



YATO  
 YT-07041 10

GB Oil transfer pump  
 D Öl-Umfüllpumpe  
 PL Pompa transferowa do oleju  
 RUS Шприц для перекачки масел  
 CZ Ruční olejová pumpa  
 H Olajpumpa  
 RO Pompa de ulei de mana  
 E Bomba manual de trasvase dual



500 cm<sup>3</sup> P max. 70 MPa P 31 MPa

YATO  
 YT-0707 20

GB Oil drainer  
 D Öl-Absaugpumpe  
 PL Odsysarka ręczna do oleju  
 RUS Ручной шприц для откачки масла  
 CZ Ruční odsávačka oleje  
 H Kézi olajszivattyú  
 RO Pompa de ulei  
 E Bomba manual de trasvase



500 cm<sup>3</sup> P max. 70 MPa P 31 MPa

YATO  
 YT-0708 20

GB Flexible tube for grease gun  
 D Schlauch für Fettpresse  
 PL Wężyk do towotnicy  
 RUS Шприц для перекачки масел  
 CZ Hadička na maznice na šmir  
 H Tömlő a zsírzóhoz  
 RO Furtun flexibil pt. pistol de gresat  
 E Manguera para engrasador



| YATO    | L (mm) |        |
|---------|--------|--------|
| YT-0709 | 300    | 12/144 |
| YT-0710 | 500    | 12/144 |

GB Oil pump  
 D Öl-Umfüllpumpe  
 PL Pompa tłokowa do oleju  
 RUS Шприц ручной заливной  
 CZ Ruční olejová pumpa  
 H Olajpumpa  
 RO Pompa de ulei de mana  
 E Bomba manual para aceite



YATO  
 YT-0712 10

16-18 l/min  
 h 45-90 cm  
 55 min<sup>-1</sup> (max)  
 0.3 l CYCLE CYKL  
 FOR OIL DO OLEJU  
 AI

GB High value rotary barrel pump  
 D Kurbelpumpe für Benzinfässer  
 PL Wysokowydajna pompa rotacyjna do paliwa  
 RUS Насос топливный ротационный  
 CZ Čerpadlo palivové rotační  
 H Kézi pumpa hordóhoz (forgatható)  
 RO Pompa rotativa pt. combustibil  
 E Bomba de combustible rotatoria



YATO  
 YT-0715 4

FOR FUEL, DIESEL, OIL DO PALIWI OLEJU  
 1.0 l CYCLE CYKL 100 l/min  
 BRASS FILTER 180 µm MOSEZNY FILTER  
 ANTISTATIC HOSE 2.4 m (WŁAZ ANTYSTATYCZNY)  
 h 100 cm  
 AI

GB Oil can with flexible nylon tube  
 D Ölkanne  
 PL Oliwiarka z wężykiem nylonowym  
 RUS Масленка  
 CZ Olejová maznice  
 H Olajozó kanna  
 RO Pompa de ulei  
 E Aceitera



| YATO    | cm <sup>3</sup> |        |
|---------|-----------------|--------|
| YT-0690 | 250             | 10/120 |
| YT-0691 | 350             | 10/120 |



- GB Two arms jaw puller  
D Abzieher-2-armig  
PL Ściągacz dwuramienny  
RUS Съёмник для подшипников  
CZ Stahovák  
H Csapaágyelhúzó  
RO Extractor rulmenti  
E Extractor

COLOR BOX

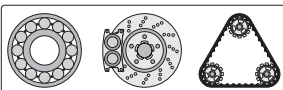

10 mm 4" 100mm



| YATO    | size / rozmiar | max. Ø (mm) | max. force / max. siła nacisku (t) |      |
|---------|----------------|-------------|------------------------------------|------|
| YT-2514 | 4" / 100 mm    | 60          | 1.2                                | 6/60 |

10 mm 3" 75mm



| YATO    | size / rozmiar | max. Ø (mm) | max. force / max. siła nacisku (t) |      |
|---------|----------------|-------------|------------------------------------|------|
| YT-2515 | 3" / 75 mm     | 75          | 1.1                                | 6/60 |

CrV

12 mm 4" 100mm



| YATO    | size / rozmiar | max. Ø (mm) | max. force / max. siła nacisku (t) |       |
|---------|----------------|-------------|------------------------------------|-------|
| YT-2516 | 4" / 100 mm    | 100         | 1.4                                | 12/48 |

17 mm 6" 150mm



| YATO    | size / rozmiar | max. Ø (mm) | max. force / max. siła nacisku (t) |       |
|---------|----------------|-------------|------------------------------------|-------|
| YT-2517 | 6" / 150 mm    | 120         | 6                                  | 10/20 |

22 mm 8" 200mm



| YATO    | size / rozmiar | max. Ø (mm) | max. force / max. siła nacisku (t) |   |
|---------|----------------|-------------|------------------------------------|---|
| YT-2518 | 8" / 200 mm    | 180         | 9                                  | 6 |

- GB Three arms jaw puller  
D Abzieher-3-armig  
PL Ściągacz trójramienny  
RUS Съёмник для подшипников  
CZ Stahovák třiramenný  
H Csapaágyelhúzó  
RO Extractor rulmenti cu trei brate  
E Extractor detres patas

COLOR BOX

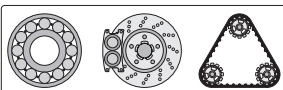

10 mm 3" 75mm



| YATO    | size / rozmiar | max. Ø (mm) | max. force / max. siła nacisku (t) |      |
|---------|----------------|-------------|------------------------------------|------|
| YT-2519 | 3" / 75 mm     | 80          | 1.5                                | 6/60 |

12 mm 4" 100mm



| YATO    | size / rozmiar | max. Ø (mm) | max. force / max. siła nacisku (t) |      |
|---------|----------------|-------------|------------------------------------|------|
| YT-2520 | 4" / 100 mm    | 100         | 2.5                                | 6/36 |

CrV

17 mm 6" 150mm



| YATO    | size / rozmiar | max. Ø (mm) | max. force / max. siła nacisku (t) |    |
|---------|----------------|-------------|------------------------------------|----|
| YT-2521 | 6" / 150 mm    | 130         | 5                                  | 12 |

22 mm 8" 200mm



| YATO    | size / rozmiar | max. Ø (mm) | max. force / max. siła nacisku (t) |   |
|---------|----------------|-------------|------------------------------------|---|
| YT-2522 | 8" / 200 mm    | 180         | 9                                  | 4 |

22 mm 12" 300mm



| YATO    | size / rozmiar | max. Ø (mm) | max. force / max. siła nacisku (t) |   |
|---------|----------------|-------------|------------------------------------|---|
| YT-2523 | 12" / 300 mm   | 180         | 11                                 | 2 |

- GB Three arms jaw puller  
D Abzieher-3-armig  
PL Ściągacz trójramienny  
RUS Съёмник для подшипников  
CZ Stahovák třiramenný  
H Csapaágyelhúzó  
RO Extractor rulmenti cu trei brate  
E Extractor detres patas

COLOR BOX

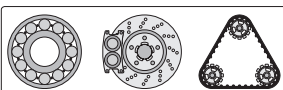

14 mm 3" 75mm

| YATO    | size / rozmiar | Ø (mm) |    |
|---------|----------------|--------|----|
| YT-2511 | 3" / 75 mm     | 50-150 | 20 |

15 mm 4" 100mm

| YATO    | size / rozmiar | Ø (mm) |    |
|---------|----------------|--------|----|
| YT-2512 | 4" / 100 mm    | 60-200 | 20 |

19 mm 6" 150mm

| YATO    | size / rozmiar | Ø (mm) |    |
|---------|----------------|--------|----|
| YT-2513 | 6" / 150 mm    | 80-300 | 10 |

CrV

- GB Universal puller set  
 D Abziehvorrichtung für Lager  
 PL Ściągacz do łożysk w miejscach trudnodostępnych  
 RUS Съёмник подшипников в труднодоступных местах  
 CZ Sada na stahování ložisek na obtížně dostupných místech  
 H Csapágyelhúzó nehezen hozzáférhető helyekhez  
 RO Trăgător pt. rulmenți în locuri greu accesibile  
 E Extractor de rodamientos en lugares de difícil acceso

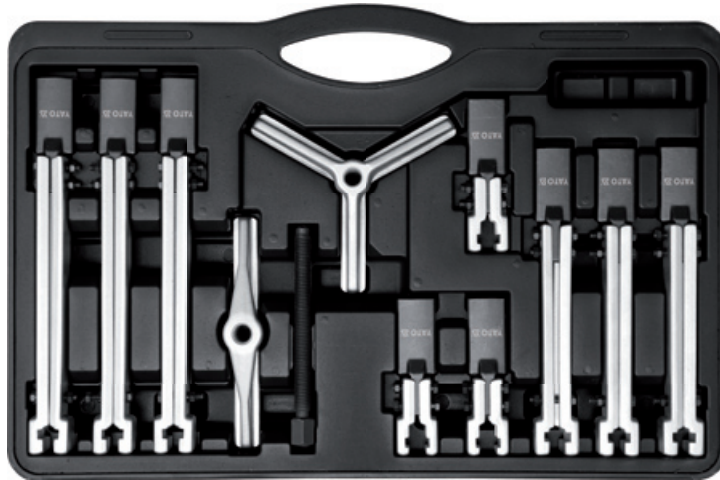
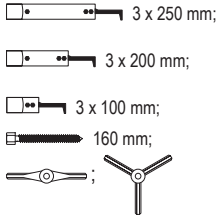

12  
PCS  
DROPPED FORGED  
KUTE

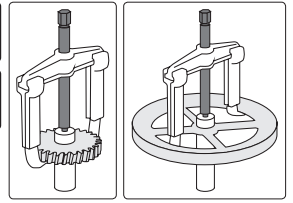

|             |   |
|-------------|---|
| <b>YATO</b> |   |
| YT-25105    | 2 |

- GB Pilot bearing puller  
 D Abzieher für Innenlager  
 PL Ściągacz do łożysk wewnętrznych  
 RUS Съёмник внутренних подшипников  
 CZ Stahovák na ložiska vnitřní  
 H Csapágyelhúzó, belső  
 RO Clește interior pt. extras rulmenți  
 E Extractor de cojinetes inter.

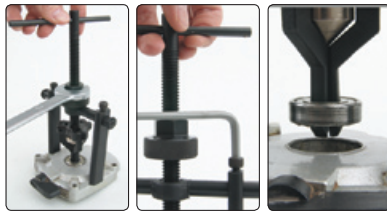

12-38  
mm  
CrV  
6150

- GB Universal wheel hub puller  
 D Scheiben-und Trommelbremsen Abzieher  
 PL Ściągacz uniwersalny do tarcz i bębnow  
 RUS Универсальный съёмник ступицы и полуоси  
 CZ Stahovák na brzdové bubny  
 H Univerzális féktárcsa és fékdob lehúzó  
 RO Trusa universala pt. transmisie cardanica  
 E Extractor universal de discos y tambores

CrV  
90-140 mm  
130-180 mm

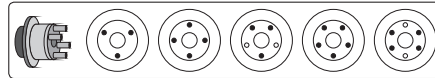

METAL CASE & COLOR BOX

|             |        |    |
|-------------|--------|----|
| <b>YATO</b> | Ø (mm) |    |
| YT-2510     | 12-38  | 20 |

|             |        |   |
|-------------|--------|---|
| <b>YATO</b> | L (mm) |   |
| YT-0602     | 200    | 6 |

- GB Separator and hydraulic cylinder tumbuckle  
 D Separator und Abziehvorrichtung mit Hydraulikservomotor  
 PL Separator i ściągacz z silownikiem hydraulicznym  
 RUS Сепаратор и съёмник с сервомотором  
 CZ Oddělovač a stahovák s hydraulickým válcem  
 H Csapágyelhúzó és körmös csapágyelhúzó hidraulikus kézpumpával  
 RO Separator și ancoră cu servomotor hidraulic  
 E Separador y tensor de tornillo con cilindro hidráulico

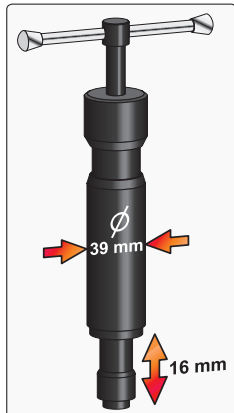

75-105 mm  
80-180 mm  
50 kN  
HRC 38-45  
DROPPED FORGED  
KUTE  
CrV



|             |        |   |
|-------------|--------|---|
| <b>YATO</b> | F (kN) |   |
| YT-0609     | 50     | 2 |

- GB Twin leg puller with jaw hook  
D Doppel-Abzieher mit Haken  
PL Ściągacz uniwersalny dwuramienny  
RUS Съёмник универсальный  
CZ Stahovák dvouramenný univerzální  
H Csapágyelhúzó készlet  
RO Carlig cu falci pt. extras  
cu picor dublu  
E Extractor de cuatro patas

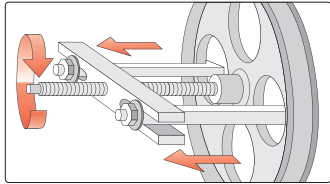
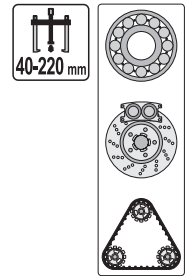

COLOR BOX

|             |    |
|-------------|----|
| <b>YATO</b> |    |
| YT-0640     | 10 |

- GB Gear puller set  
D Lagerabzieher, Trennmesser  
PL Ściągacz dwuramienny i separator  
RUS Съёмник универсальный с сепаратором  
CZ Stahovák dvouramenný

- H Csapágyelhúzó készlet  
RO Set angrenaj pt. extras  
E Kit de extractor

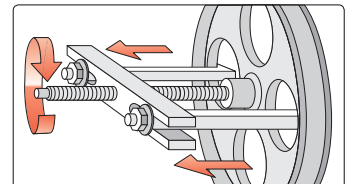
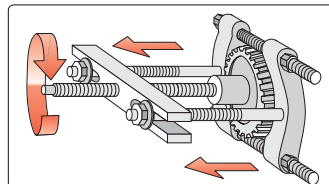
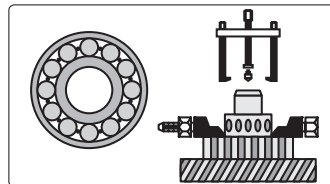
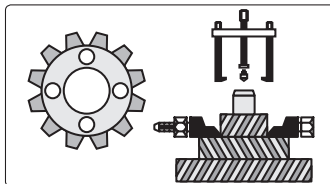
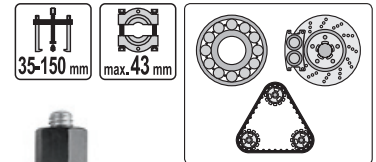

BMC & COLOR BOX

|             |   |
|-------------|---|
| <b>YATO</b> |   |
| YT-0641     | 4 |

- GB Steering wheel remover / lock plate compressor set  
D Abziehvorrichtung für das Lenkrad  
PL Ściągacz koła kierownicy / sprężarki  
RUS Съёмник рулевого колёса  
CZ Přípravek na stahování volantu  
H Kormánykerék-lehúzó  
RO Volar puller  
E Desmontador para el volante

- 5/16" x 101 mm, 18 TPI;
- M8 x 89 mm;
- 3/8" x 89 mm, 16 TPI;
- 5/16" x 89 mm, 24 TPI;
- M14 x 1.5 mm;
- 9/16", 18 TPI;

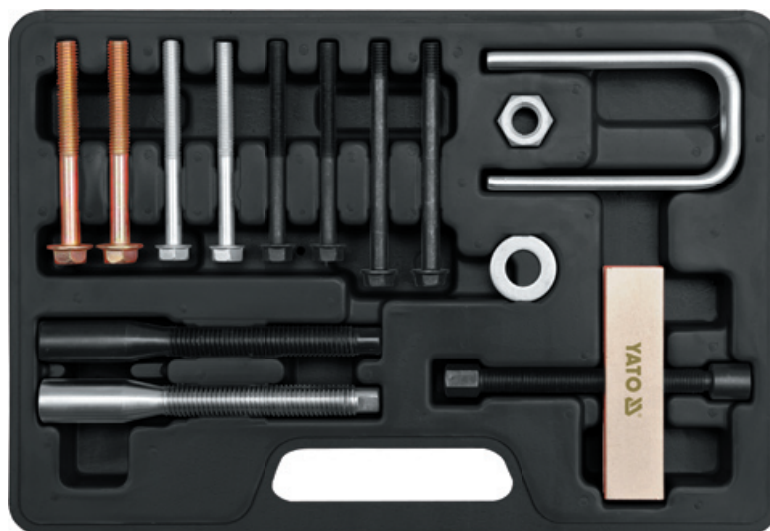
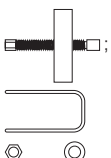

14  
PCS

BMC & COLOR SLEEVE

|             |    |
|-------------|----|
| <b>YATO</b> |    |
| YT-2545     | 10 |

GB Slide hammer gear / bearing puller set  
 D Träge Abziehvorrchtung für Lager  
 PL Ściągacz bezwładnościowy do łożysk  
 RUS Инерционный съёмник подшипников

CZ Rázový stahovák s kluzným kladivem na ložiska  
 H Csúszósúlyos csapágyelhúzó készlet  
 RO Set ciocan culisant extractor de rulmenti  
 E Extractor de inercia para cojinetes

5  
PCS

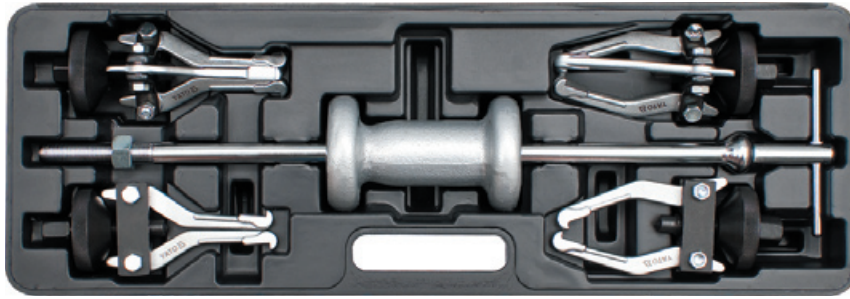
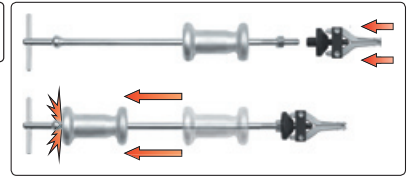

BMC & COLOR SLEEVE

|             |   |
|-------------|---|
| <b>YATO</b> |   |
| YT-2540     | 2 |

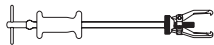

External 3-jaw puller  
Ściągacz 3-ramienny zewnętrzny

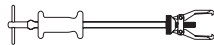

External 2-jaw puller  
Ściągacz 2-ramienny zewnętrzny

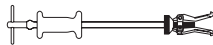

Internal 3-jaw puller  
Ściągacz 3-ramienny wewnętrzny

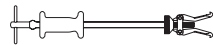

Internal 2-jaw puller  
Ściągacz 2-ramienny wewnętrzny

GB Slide hammer set  
 D Träge Abziehvorrchtung für Naben und Lager  
 PL Ściągacz bezwładnościowy do piast i łożysk  
 RUS Инерционный съёмник ступиц и подшипников

CZ Rázový stahovák s kluzným kladivem na náboje a ložiska  
 H Csúszósúlyos kerékagy- és csapágyelhúzó készlet  
 RO Set ciocan culisant extractor de rulmenti și bușce  
 E Extractor de inercia para cubos y cojinetes

13  
PCS

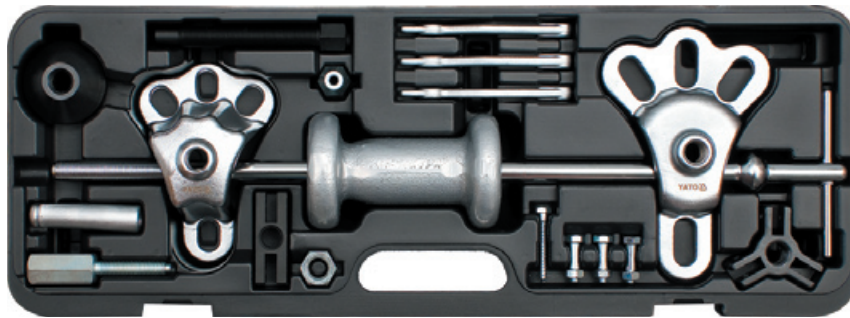
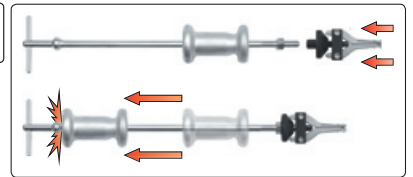

BMC & COLOR SLEEVE

|             |   |
|-------------|---|
| <b>YATO</b> |   |
| YT-2539     | 2 |

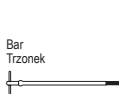

Bar  
Trzonek



Hammer  
Młot



Axle puller  
Ściągacz osi



Grip wrench adaptor  
Przejsiówka do klucza



Nut  
Kołnier



2-jaw head  
Głowica 2-zaczeпова



3-jaw head  
Głowica 3-zaczeпова



Nut & bolt  
Nakrętka i śruba



Attachment  
Gniazdo śruby



Leg  
Ramię ściągacza



Screw  
Śruba



Hook  
Hak

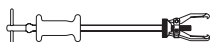

External 3-jaw puller  
Ściągacz 3-ramienny zewnętrzny

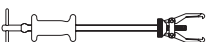

External 2-jaw puller  
Ściągacz 2-ramienny zewnętrzny



Puller hook  
Hak



Dent puller  
Ściągacz blacharski



Internal 3-jaw puller  
Ściągacz 3-ramienny wewnętrzny



Internal 2-jaw puller  
Ściągacz 2-ramienny wewnętrzny

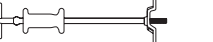

Rear axle puller  
Ściągacz tylniej osi



Grip wrench adaptor  
Adapter klucza

GB Front wheel bearing adapter set  
 D Radlagerabzieher werkzeugsatz vorderachse  
 PL Ściągacz łożysk piasty przedniej  
 RUS Набор для снятия переднего подшипника переднеприводных автомобилей  
 CZ Sada na demontáž ložisek přední nápravy  
 H Csapágyelhúzó adapter készlet első futóműhöz  
 RO Set schimbat rulment roata fata  
 E Extractor de cojinetes para cubos de rueda delanteros

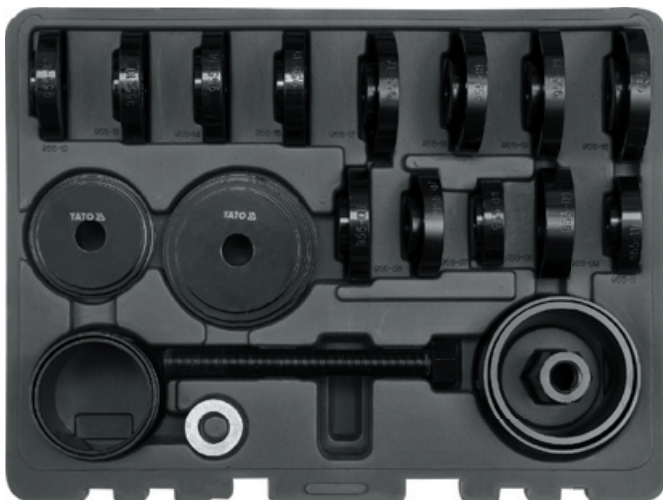

FOR FRONT WHEEL BEARING DO ŁOŻYSK PIASTY PRZEDNIEJ

23  
PCS

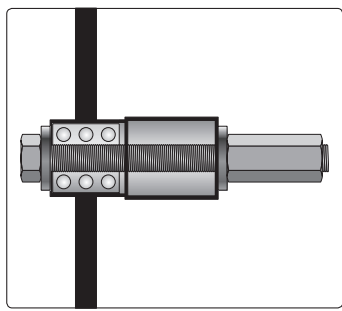

|             |   |
|-------------|---|
| <b>YATO</b> |   |
| YT-2541     | 2 |

GB Small mouth pull clamp  
D Selbstklemmende Blechselle  
PL Klamra blacharska samozaciskowa  
RUS Скрепa самозажимная для жестяных работ  
CZ Karosářská svěrka samosvorná k tahání

H Önszorító húzóató pofa, egyenes  
RO Clemă pt. tablă cu strângere automată  
E Grapa de hojalatería autoprensora

**5t** **125 mm** **42x20mm JAWS SZCZĘKI** **AUTO-TIGHTEN SAMO-ZACISKOWA**

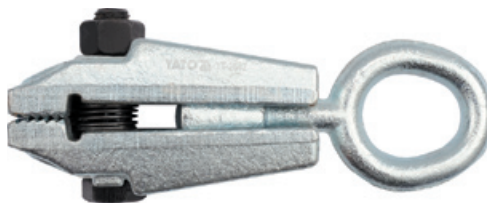
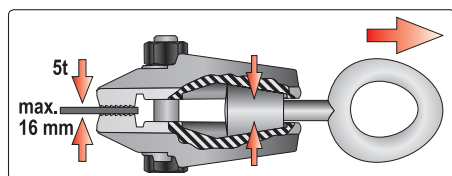

| YATO    | L (mm) |    |
|---------|--------|----|
| YT-2542 | 125    | 12 |

GB Box clamp  
D Selbstklemmende Blechselle vom Typ „C“  
PL Klamra blacharska samozaciskowa typu „C“  
RUS Скрепa самозажимная для жестяных работ типа „C“  
CZ Karosářská svěrka samosvorná k tahání typ „C“  
H Önszorító húzóató pofa, öblös  
RO Clemă pt. tablă cu strângere automată de tip „C“  
E Grapa de hojalatería autoprensora tipo „C“

**3t** **142 mm** **35x15mm JAWS SZCZĘKI** **TYPE C** **AUTO-TIGHTEN SAMO-ZACISKOWA**

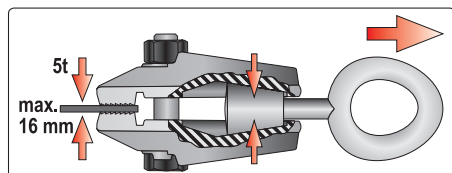

| YATO    | L (mm) |    |
|---------|--------|----|
| YT-2543 | 142    | 10 |

GB Twist socket set  
D Schraubendrehersatz  
PL Zestaw wykrętaaków do śrub  
RUS Набор отверток  
CZ Sada vrtahováků stržených šroubů

H Kicsavaró készlet csavarokhoz  
RO Set de chei pt. șuruburi  
E Juego de destornilladores

**3/8"** **10 PCS**  
**10 mm** **CrMo HRC 52-55**

GB Screw extractor set & HSS drill bits  
D Schraubenausdrehersatz & HSS Bohrer  
PL Wykrętaaki do zerwanych śrub i wiertła do metalu HSS  
RUS Экстракторы и сверла по металлу HSS  
CZ Vrtáky do přetržených šroubů & vrtáky na kov HSS  
H Törtcsavar kihajtó & főrészár fémhez HSS  
RO Capete pt. deșurubat șuruburi rupte & burghie pt. metal HSS  
E Destornillador para tornillos arrancados & HSS brocas

**12 PCS** **HSS**  
**M3-M24**

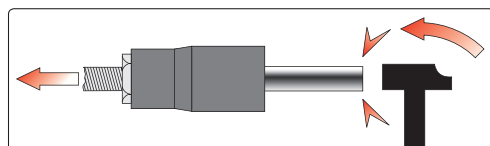

| YATO    |      |
|---------|------|
| YT-0603 | 8/32 |

| YATO    | Ø (mm)   | M     | Ø (mm) |    |
|---------|----------|-------|--------|----|
| YT-0591 | 1.4-3.6  | 3-6   | 1.8    | 40 |
|         | 2.1-4.9  | 6-8   | 2.6    |    |
|         | 3.1-6.5  | 8-11  | 3.7    |    |
|         | 4.8-8.8  | 11-14 | 5.5    |    |
|         | 6.2-11.0 | 14-18 | 7.0    |    |
|         | 9.4-15.0 | 18-24 | 10.3   |    |

GB Screw extractor set  
D Schraubenausdrehersatz  
PL Wykrętaaki do zerwanych śrub  
RUS Набор для извлечения обломанных болтов  
CZ Vrtáky do přetržených šroubů

H Törtcsavar kihajtó  
RO Capete pt. deșurubat șuruburi rupte  
E Destornillador para tornillos arrancados

**6 PCS**



| YATO    | Ø (mm) | L (mm) |       |
|---------|--------|--------|-------|
| YT-0590 | 3-6    | 52     | 12/48 |
|         | 6-8    | 58     |       |
|         | 8-11   | 66     |       |
|         | 11-14  | 75     |       |
|         | 14-18  | 80     |       |
|         | 18-25  | 88     |       |

GB Bolt extractor set  
 D Satz von Ausziehvorrichtungen für Stifte  
 PL Zestaw wykręteków do szpilek  
 RUS Набор экстракторов для шпилек

CZ Souprava na demontáž závrtných šroubů  
 H Csavarkihajító készlet  
 RO Set de șurubelnițe pt. tije  
 E Juego de extractores de alfileres



STEEL  
8660  
HRC  
49-52

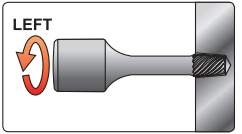

6  
PCS  
3/8"  
10  
mm



5  
PCS  
1/2"  
12.5  
mm

| YATO    | Ø (mm)            |    |
|---------|-------------------|----|
| YT-0623 | 2; 3; 4; 6; 8; 10 | 50 |

| YATO    | Ø (mm)            |    |
|---------|-------------------|----|
| YT-0624 | 8; 10; 12; 14; 16 | 20 |

GB Heavy duty nut splitter  
 D Meißelsatz für Schraubenmuttern  
 PL Zestaw przecinaków do nakrętek  
 RUS Набор зубил для гаек  
 CZ Souprava sekáčů na matice  
 H Csavaranya-vágó  
 RO Set rețezătoare capace  
 E Juego de tajaderas para tuercas



4  
PCS  
CrV  
HRC  
40-45

5/16" - 1/2" (9 - 12 mm);  
 1/2" - 5/8" (12 - 16 mm);  
 5/8" - 7/8" (16 - 22 mm);  
 7/8" - 1-1/16" (22 - 27 mm)

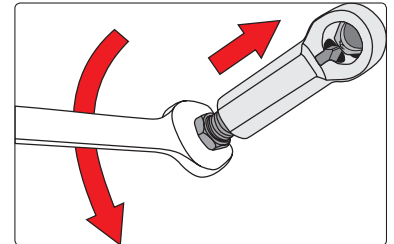

| YATO    |    |
|---------|----|
| YT-0585 | 10 |

GB Roller stud extractor set  
 D Stehbolzenlösersatz  
 PL Komplet wykręteków do szpilek  
 RUS Набор ключей для снятия штифтов  
 CZ Sada stahovadel na špendlíky  
 H Komplet tükkihúzó  
 RO Set de dispozitive pt. demontat șuruburi rupte  
 E Juego de extractores de agujas



4  
PCS  
CrV  
50BV30

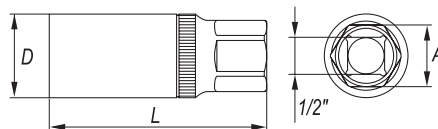
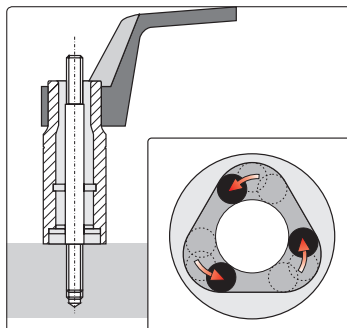

| YATO    | ● (mm) | D (mm) | L (mm) | A (mm) |      |
|---------|--------|--------|--------|--------|------|
| YT-0620 | 6      | 24     | 60     | 21     | 6/24 |
|         | 8      |        |        |        |      |
|         | 10     | 28     | 70     |        |      |
|         | 12     |        |        |        |      |

GB Tie rod end lifter  
D Universal-Kugelgelenk-Abzieher  
PL Ściągacz do sworzni kulistych  
RUS Съёмник шаровых опор

CZ Stahovák kulových čepů řízení  
H Gömbfej kinyomó  
RO Extractor pt. articulatii sferice  
E Extractor de pernos esféricos

135  
mm



COLOR BOX



| YATO    | (mm) | L (mm) | Ø (mm) |      |
|---------|------|--------|--------|------|
| YT-0612 | 19   | 135    | 17.5   | 9/18 |

GB Tie rod end lifter  
D Universal-Kugelgelenk-Abzieher  
PL Ściągacz do sworzni kulistych  
RUS Съёмник шаровых опор

CZ Stahovák kulových čepů řízení  
H Gömbfej kinyomó  
RO Extractor pt. articulatii sferice  
E Extractor de pernos esféricos

265  
mm

275  
mm

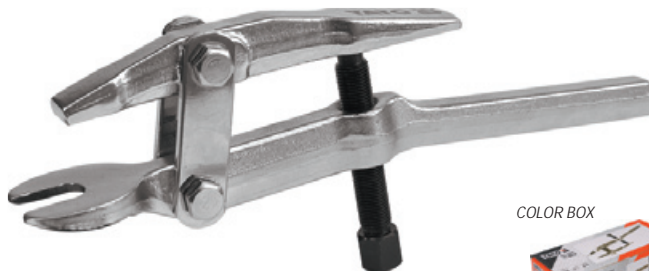

COLOR BOX



| YATO    | (mm) | L (mm) | Ø (mm) |    |
|---------|------|--------|--------|----|
| YT-0613 | 16   | 265    | 17     | 20 |
| YT-0614 | 16   | 275    | 20     | 20 |

GB Rod end remover  
D Lenkstangeabzieher  
PL Ściągacz do drążków kierowniczych  
RUS Съёмник рулевых тяг  
CZ Přípravek na demontáž kulových čepů řízení  
H Gömbfej kiütő  
RO Tija pt. indepărtat  
E Extractor de barras de acoplamiento



200  
mm

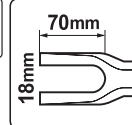

COLOR BOX



| YATO    | L (mm) |       |
|---------|--------|-------|
| YT-0615 | 200    | 18/36 |

GB Tie rod / ball joint tool kit  
D Werkzeugsatz für Bremssattel  
PL Ściągacze do drążków  
RUS Съёмник штанг  
CZ Stahováky táhel řízení  
H Rüdlehúzó  
RO Ancore pt. tije  
E Tensores para palancas

for / dla: YT-0990

5  
PCS

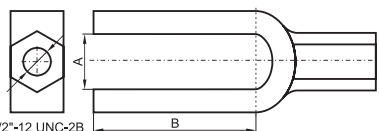
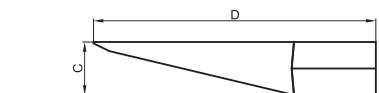
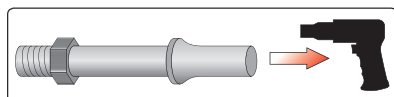
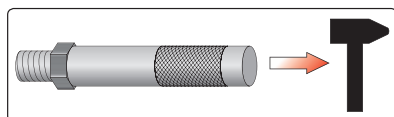

1/2"-12 UNC-2B



BMC & COLOR BOX



| YATO    | A (mm) | B (mm) | C (mm) | D (mm) |       |
|---------|--------|--------|--------|--------|-------|
| YT-0616 | I      | 18.2   | 65.0   | 24.0   | 123.9 |
|         | II     | 25.2   | 67.8   |        |       |
|         | III    | 30.2   | 56.3   |        |       |

GB Seal puller  
D Dichtungs-Abziehwerkzeug  
PL Ściągacz do uszczeltek  
RUS Съёмник прокладок  
CZ Škrabka na těsnění  
H Tömítéselhúzó  
RO Ancoră pt. garnituri  
E Tensor para juntas

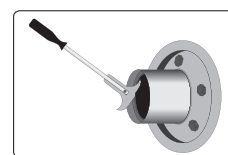

max. Ø  
85 mm



SLIDING CARD

| YATO    | L (mm) |       |
|---------|--------|-------|
| YT-0642 | 200    | 12/48 |

- GB Bearing race and seal driver set
- D Presssatz für Sicherungsringe, Lager, etc.
- PL Zestaw do osadzania łożysk i uszczelniaczy
- RUS Втулка и набор сальниковых уплотнителей для автомобиля
- CZ Sada na montáž gufer
- H Csapágy, szimering, persely ki- és beütő készlet
- RO Set pt. inlocuiri rulment, simering
- E Jugeo de conductores del anillo y del sello de rodadura



10  
PCS

AI

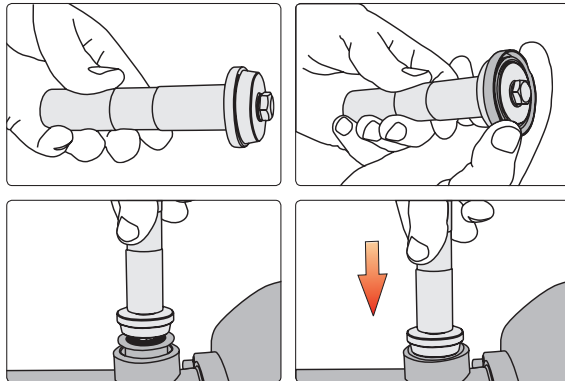

| YATO    | No. | Ø (mm) |      |
|---------|-----|--------|------|
| YT-0638 | 01  | 40     | 5/10 |
|         | 02  | 44     |      |
|         | 03  | 50     |      |
|         | 04  | 59     |      |
|         | 05  | 63     |      |
|         | 06  | 65     |      |
|         | 07  | 72     |      |
|         | 08  | 76     |      |
|         | 09  | 81     |      |

BMC  
& COLOR  
SLEEVE



- GB Car radio removal tool set
- D Autoradio Demontage Werkzeugsatz
- PL Zestaw do demontażu radiodiodniaków samochodowych
- RUS Набор для разборки авто-ресиверов
- CZ Sada k demontáži autorádií
- H Autórádió kiszerező készlet
- RO Trusa de scule pt. indepartat radio
- E Jugeo para el desmontaje de autorradio

SLIDING  
CARD



36  
PCS

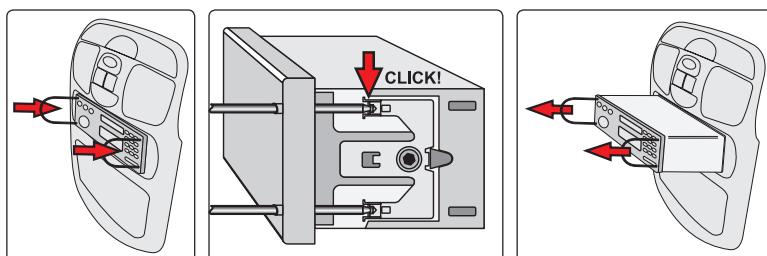
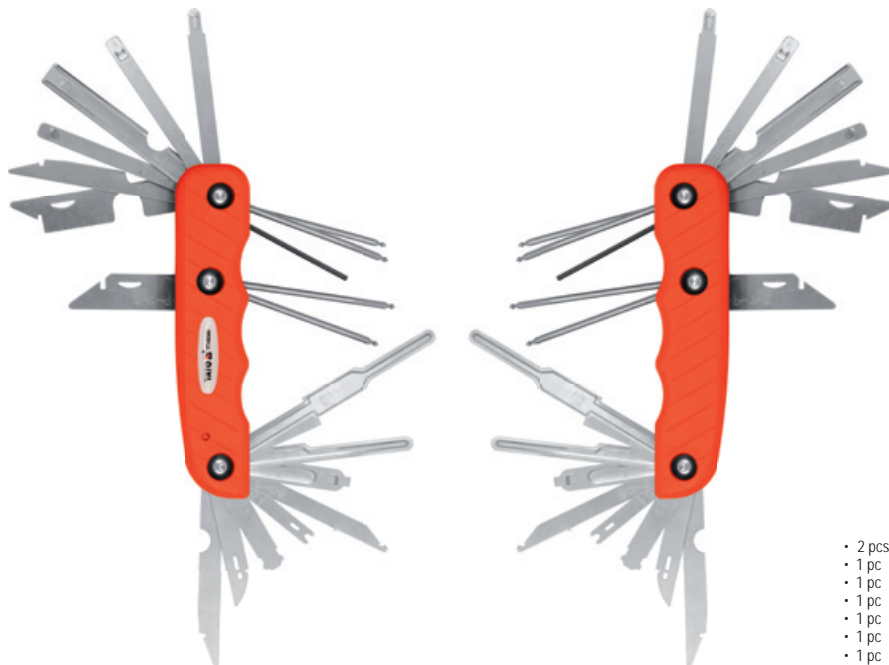

- 2 pcs P-01 Mercedes Benz, VW, Audi, Becker
- 1 pc P-02 Mercedes Benz, Porsche, Becker
- 1 pc P-03 VW
- 1 pc P-04 Skoda
- 1 pc P-05 Becker
- 1 pc P-07 Clarion
- 1 pc P-08 Kenwood
- 1 pc P-09 Sony
- 1 pc P-10 Kenwood
- 1 pc P-11-1 - Fiat Bravo, Fiat Brava
- 1 pc P-11-2 - Fiat Bravo, Fiat Brava
- 1 pc P-12 - Pioneer, JVC
- 1 pc P-13 - Panasonic
- 1 pc P-14 - Panasonic
- 1 pc P-15 - Sony
- 1 pc BMW
- 1 pc BMW, Opel
- 2 pcs Opel, Grundig, Blaupunkt
- 2 pcs VW, Audi, Ford

YATO  
YT-08380

12/24



- GB** Car radio removal tool set  
**D** Autoradio Demontage Werkzeugsatz  
**PL** Zestaw do demontażu radioodbiorników samochodowych  
**RUS** Набор для разборки авто-ресиверов  
**CZ** Sada k demontáži autorádií  
**H** Autórádió kiszerező készlet  
**RO** Trusa de scule pt. indepartat radio  
**E** Juego para el desmontaje de autorradio

- 2 radio removal U-hook (Ford, VW, Audi, Grundig, Blaupunkt)
- 1 special pentagon wrench (BMW)
- 4 radio removal keys (VW, Audi, Becker, Mercedes)
- 2 radio removal keys (Mercedes, Porsche, Becker)
- 2 radio removal keys (VW)
- 1 allen hex wrench (BMW, Opel)
- 2 radio removal keys (new Becker)
- 2 radio removal keys (new Skoda)
- 2 radio removal keys U-hook (new Blaupunkt)
- 2 radio removal keys (Fiat Brava)
- 2 radio removal U-hook (Opel Doppel-Kugel-Inbus)
- 6 radio removal keys (Mercedes-Benz, BMW)
- 2 radio removal keys (Kenwood II 1998-2001)
- 2 radio removal keys (Sony II since 2002)
- 2 radio removal keys (Kenwood III since 2002)
- 2 radio removal keys (Pioneer, JVC)
- 2 radio removal keys (Sony I until 2001)
- 2 radio removal keys (Panasonic)
- 2 radio removal keys (Kenwood I until 1998)
- 2 radio removal keys (Kenwood mask)
- 2 radio removal keys (new Clarion)
- 2 radio removal keys (old Clarion)
- 2 radio removal keys (Panasonic 2006)
- 2 radio removal keys (Sony IDIC 2005)

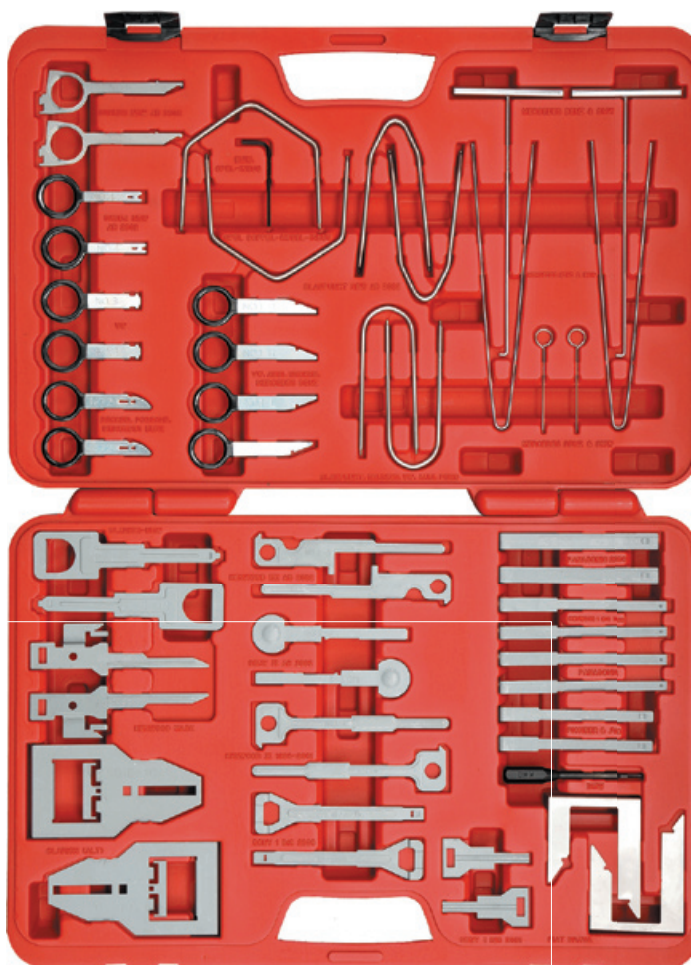

**52**  
PCS

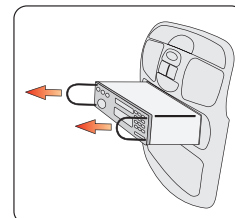
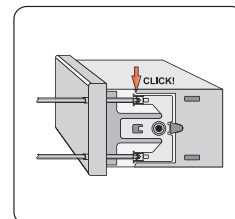
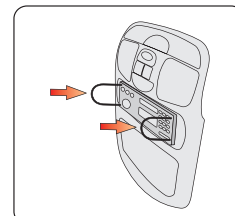

BMC  
& COLOR  
SLEEVE



|             |    |
|-------------|----|
| <b>YATO</b> |    |
| YT-0838     | 10 |

- GB** Emergency automotive lock-out tool set  
**D** Werkzeugsatz zum Öffnen der Autotür im Notfall  
**PL** Zestaw do awaryjnego otwierania drzwi samochodowych  
**RUS** Набор для аварийного відкриття автомобільних дверей  
**CZ** Souprava k nouzovému otevírání dveří automobilů  
**H** Személygépkocsi ajtó vésznyitó készlet  
**RO** Set pt. deschidere de avarie a ușilor de mașină  
**E** Juego de herramientas para abrir las puertas de coche en casos de urgencia

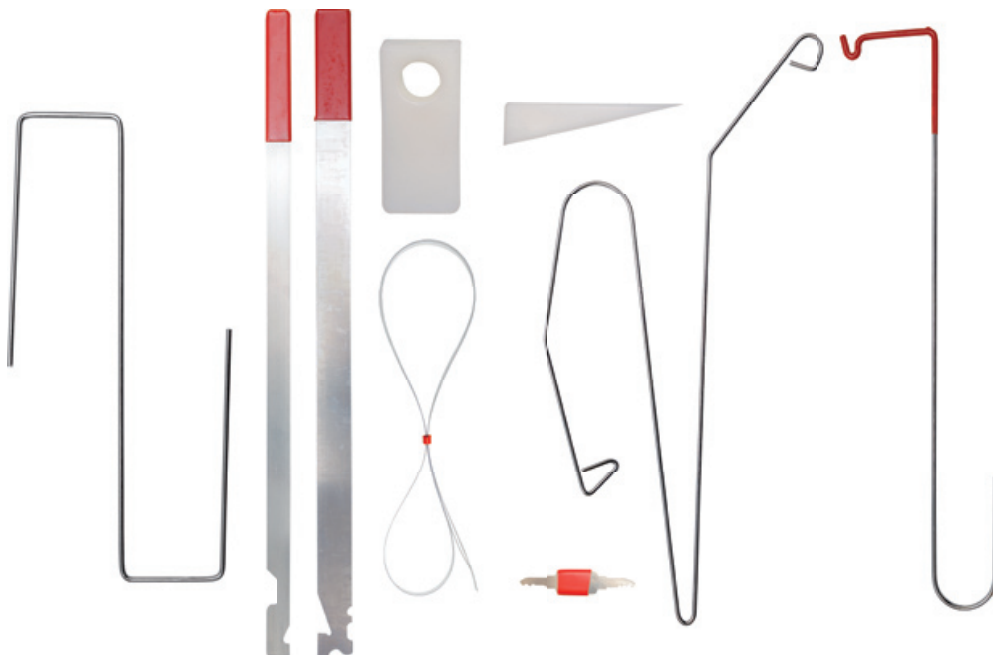

**9**  
PCS

STAINLESS  
STEEL  
STAL  
NERZEWA

PVC

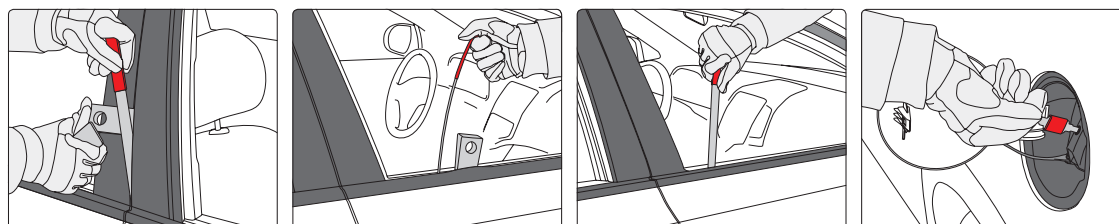

POUCH

|             |    |
|-------------|----|
| <b>YATO</b> |    |
| YT-08385    | 25 |

- GB Universal terminal release tool set
- D Werkzeugsatz für Konektorverbindungen
- PL Zestaw do złączy konektorowych
- RUS Комплект для коннекторных разъемов
- CZ Souprava na konektorové spojky
- H Szerszámkészlet konnektoros csatlakozásokhoz
- RO Set pt. cuplări conectoare
- E Juego para conexiones de aflojamiento rápido

12  
PCS

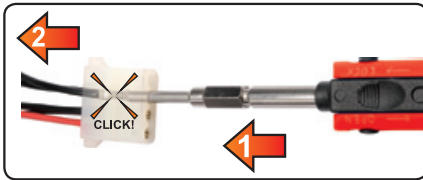
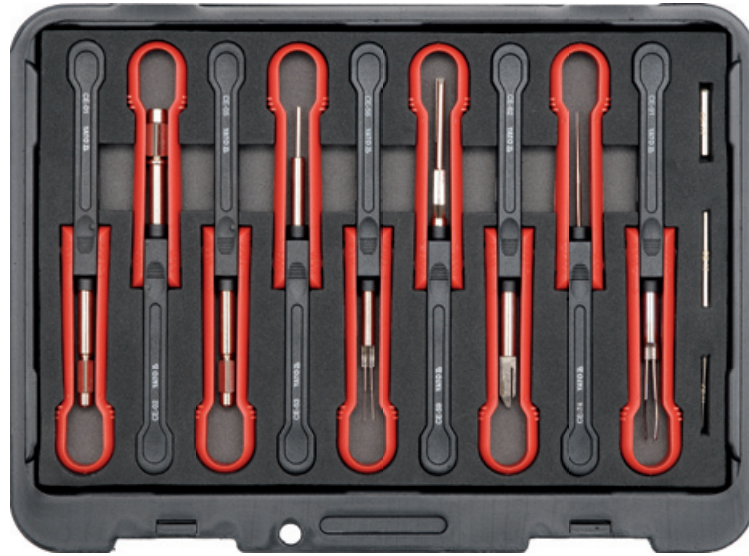

BMC  
& COLOR  
SLEEVE



| YATO     | No.      | description / opis   | application / zastosowanie   |    |
|----------|----------|--|--|----|
| YT-08430 | CE-01+11 | ejection tools for contact sizes Ø 1.5 mm w/dismantling sleeves for contact sizes narzędzie do odłączania styków o rozmiarze Ø 1.5 mm wraz z tuleją do demontażu | BMW, Daimler Chrysler, Fiat, MAN, Opel, Porsche, Seat, Skoda, VW, Audi               | 10 |
|          | CE-02+12 | ejection tools for contact sizes Ø 3.5 mm w/dismantling sleeves for contact sizes narzędzie do odłączania styków o rozmiarze Ø 3.5 mm wraz z tuleją do demontażu | BMW, Daimler Chrysler, Fiat, MAN, Opel, Porsche, Seat, Skoda, VW, Audi               |    |
|          | CE-05+15 | ejection tools for contact sizes Ø 2.3 mm w/dismantling sleeves for contact sizes narzędzie do odłączania styków o rozmiarze Ø 2.3 mm wraz z tuleją do demontażu | Ford, Opel, PSA, Renault   |    |
|          | CE-53    | cable extractor tool for plugs with one release channel 2.8 and 5.8 mm wykrętek do przewodów z pojedynczym złączem 2.8 i 5.8 mm                                  | BMW, Daimler Chrysler, Ford, MAN, Opel, Porsche, PSA, Renault, Seat, Skoda, VW, Audi |    |
|          | CE-56    | cable extractor tool for Microtimer II, III contacts Ø 1.6 mm wykrętek do przewodów Microtimer II, III styki Ø 1.6 mm  | Daimler Chrysler, Opel, Porsche, PSA, Renault, Saab, Seat, Skoda, VW, Audi           |    |
|          | CE-59    | cable extractor tool for Maxipower Timer contacts 9.5 mm wykrętek do styków Maxipower Timer 9.5 mm   | Daimler Chrysler, VW, Audi   |    |
|          | CE-62    | cable extractor tool for Pit-Pod contacts wykrętek do styków Pit-Pod   | all vehicles<br>wszystkie pojazdy  |    |
|          | CE-74    | cable extractor tool for Microtimer I contacts and ABS plug-in housing Ø 1.6 mm wykrętek do styków Microtimer I i osłony wtyku ABS Ø 1.6 mm                      | Fiat, Ford, Mazda, Opel, PSA, Renault, Saab, VW, Audi                                |    |
|          | CE-91    | cable extractor tool for plugs with two release channels 2.8 and 5.8 mm wykrętek do przewodów z podwójnym złączem 2.8 i 5.8 mm                                   | BMW, Daimler Chrysler, Fiat, Ford, MAN, Opel, PSA, Renault, Saab, VW, Audi           |    |

- GB Airbag removal tool set
- D Schlüssel zur Demontage des Luftkissen
- PL Klucze do demontażu poduszki powietrznej
- RUS Набор ключей для демонтажа подушки безопасности
- CZ Klíče na demontáž airbagu
- H Kulcsok légszák leszereléséhez
- RO Chei pt. demontare airbag
- E Llaves para desmantelamiento de bolsas de aire

12  
PCS

HRC  
45-50

CrV  
6150



BMC  
& COLOR  
SLEEVE



for / dla: BMW, Audi, Opel, Renault, Mercedes, VW Passat, VW Polo, VW Lupo, VW Golf 4, VW Beetle, VW Jetta, VW Bora, Seat, Skoda Fabia, Skoda Octavia

YATO  
YT-06291 10

GB Door upholstery remover  
D Abziehvorrichtung für Polstererklammern  
PL Ściągacz do spinek tapicerki

RUS Съемник крепежа обивки  
CZ Uvolňovač čalounění dveří  
H Kárpitkiszedő

RO Dispozitiv de scos  
agrafe de tapiterie  
E Extractor de grapas de vestidura

SVCM



| YATO    | size / rozmiar (mm) |        |
|---------|---------------------|--------|
| YT-1370 | 6x100               | 12/120 |

| YATO    | size / rozmiar (mm) |        |
|---------|---------------------|--------|
| YT-1371 | 6.2x115             | 12/120 |



| YATO    | size / rozmiar (mm) |        |
|---------|---------------------|--------|
| YT-1372 | 10x115              | 12/120 |

| YATO    | size / rozmiar (mm) |      |
|---------|---------------------|------|
| YT-1373 | 9.5x134             | 6/96 |

GB Scratch awl  
D Einfache Spicknadel  
PL Szpikulec prosty

RUS Прямое острие  
CZ Šídlo rovné  
H Spékélőtű, egyenes

RO Dorn perforare drept  
E Punzón recto

SVCM



| YATO    | L (mm) |        |
|---------|--------|--------|
| YT-1374 | 120    | 12/120 |

GB Hook bodkin  
D Hakenspicknadel  
PL Szpikulec hakowy

RUS Крюковое острие  
CZ Šídlo háčkové  
H Spékélőtű, horgos

RO Dorn perforare indoit  
E Punzón encorvado

SVCM



| YATO    | L (mm) |        |
|---------|--------|--------|
| YT-1376 | 90     | 12/120 |

| YATO    | L (mm) |        |
|---------|--------|--------|
| YT-1375 | 125    | 12/120 |

GB Battery cap tool  
D Abbrechklingen für Akkuklemmen  
PL Ściągacz do клем akumulatora  
RUS Стяжка для клемм аккумулятора

CZ Stahovák svorek akumulátoru  
H Akkumulátor saru lehűző  
RO Extractor pt. clem akumulator  
E Extractor para los bornes de la batería

SVCM



GB Glass scraper  
D Scheibenkratzer  
PL Skrobak do szyby

RUS Шабер для стекла  
CZ Škrabka na okna  
H Jégkaparó

RO Răzuitor geamuri  
E Rascador para los vidrios

SVCM



| YATO    | size / rozmiar (mm) |        |
|---------|---------------------|--------|
| YT-1378 | 18.5x100            | 12/120 |

| YATO    | size / rozmiar (mm) |      |
|---------|---------------------|------|
| YT-1379 | 39x200              | 6/72 |

GB Spare blades for glass scraper  
D Abbrechklingen  
PL Ostrze do skrobaka do szyby  
RUS Лезвия для универсальных ножей  
CZ Lomené ostří náhradní  
H Törhető tartalékpenge  
RO Lame de rezervă rupte  
E Filo partido de recambio



10 PCS SK5

for / dla: YT-1379



GB Flexible spinner handle  
D Elastischer Dreher  
PL Pokrętko elastyczne

RUS Эластичный вороток  
CZ Šroubovák ohebný  
H Hajlékony csavarhúzó

RO Mâner flexibil  
E Llave flexible

SVCM



1/4"

6.3 mm

| YATO     | size / rozmiar (mm) |    |
|----------|---------------------|----|
| YT-13790 | 19x39               | 50 |

| YATO    | size / rozmiar         |      |
|---------|------------------------|------|
| YT-1381 | 1/4" (6.3 mm) x 150 mm | 6/96 |

GB Flexible magnetic bit driver  
D Elastischer Dreher für Bits  
PL Pokręto elastyczne do bitów

RUS Эластичный вороток для разряда битов  
CZ Šroubovák ohebný na bity

H Hajlékony csavarhúzó bit  
RO Mâner flexibil pt. vârf șurubelniță  
E Mango flexible para desarmadores



| YATO    | size / rozmiar         |      |
|---------|------------------------|------|
| YT-1382 | 1/4" (6.3 mm) x 380 mm | 6/72 |

GB Flexible magnetic pick up tool  
D Elastische Magnethalterung  
PL Elastyczny uchwyt magnetyczny

RUS Эластичный магнитный держатель  
CZ Ohebný magnetický držák  
H Hajlékony mágneses szár

RO Mâner magnetic flexibil  
E Mango magnético flexible



| YATO    | L (mm) |      |
|---------|--------|------|
| YT-1385 | 400    | 6/72 |

GB Flexible hose clip screwdriver  
D Steckschlüssel, elastisch  
PL Klucz nasadowy elastyczny

RUS Эластичный торцевой ключ  
CZ Klíč nástrčný ohebný  
H Hajlékony dugókulcs

RO Cheie tubulara flexibilă  
E Llave de tubo flexible



| YATO    | size / rozmiar (mm) |      |
|---------|---------------------|------|
| YT-1390 | 6x150               | 6/96 |



| YATO    | size / rozmiar (mm) |      |
|---------|---------------------|------|
| YT-1391 | 7x150               | 6/96 |



| YATO    | size / rozmiar (mm) |      |
|---------|---------------------|------|
| YT-1392 | 8x150               | 6/96 |

GB Hook screwdriver  
D Winkelschraubendreher  
PL Wkrętak kątowy

RUS Отвёртка  
CZ Šroubovák  
H Csavarhúzó

RO Șurubelniță  
E Destornillador



| YATO     |   | PCS packing |        |
|----------|---|-------------|--------|
| YT-28480 | 6 | 12          | 36/144 |

GB Universal hook & pick set  
D Hacken- und Durchtreiberset  
PL Zestaw haków  
RUS Набор крюков  
CZ Sada háků a šidel

H Kampós ár szet  
RO Set surubelnite cu varf ascutit si cotit  
E Juego de ganchos

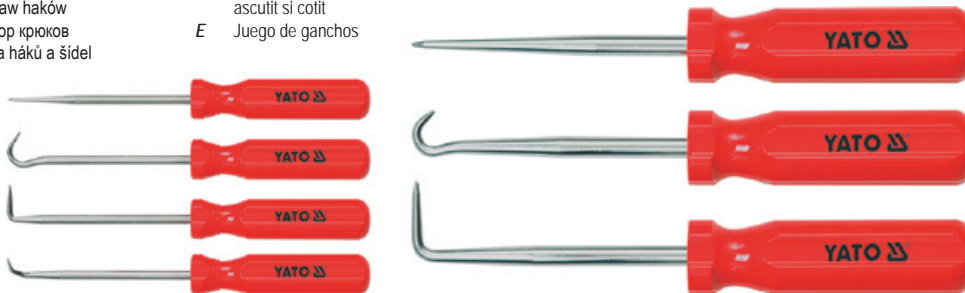
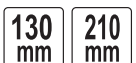

| YATO    |  |    |
|---------|--|----|
| YT-0839 |  | 10 |

GB Door upholstery remover  
D Abziehvorrichtung für Polstererklammern

PL Ściągacz do spinek tapicerki  
RUS Съёмник крепежа обивки  
CZ Uvolňovač čalounění dveří

H Kárpitkiszedő  
RO Dispozitiv de scoas agrafe de tapițerie  
E Extractor de grasas de vestidura



| YATO    | L (mm) |       |
|---------|--------|-------|
| YT-0841 | 230    | 16/64 |



| YATO    | L (mm) |        |
|---------|--------|--------|
| YT-0842 | 200    | 25/100 |

- GB Panel removal set  
D Abziehvorrichtung für Polsterung  
PL Ściągacze do tapicerki  
RUS Съемник обивки  
CZ Sada k demontáži čalounění  
H Kárpitlehűző  
RO Ancore pt. tapițerie  
E Tensores para las vestiduras

DOUBLE  
BLISTER



IMPACT  
RESISTANT  
NYLON  
ODPORNE  
NA UDARZENIA  
NO SCRATCH  
BEZ  
ZADRAPAN

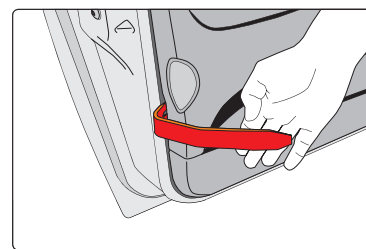

5

PCS

6

PCS



**YATO**  
YT-0836 6/24

**YATO**  
YT-0837 6/24

- GB Panel removal set  
D Abziehvorrichtung für Polsterung  
PL Ściągacze do tapicerki  
RUS Съемник обивки  
CZ Sada k demontáži čalounění  
H Kárpitlehűző  
RO Ancore pt. tapițerie  
E Tensores para las vestiduras

POUCH  
& COLOR  
BOX



11

PCS

- GB Set of plastic scrapers  
D Satz von Kunststoffschabern  
PL Zestaw skrobaków plastikowych  
RUS Набор пластмассовых шаберов  
CZ Souprava plastových škrabek

- H Müanyag vakaró készlet  
RO Set de răzuitoare din plastic  
E Juego de rascadores de plástico

4

PCS

265

mm

IMPACT  
RESISTANT  
NYLON  
ODPORNE  
NA UDARZENIA  
NO SCRATCH  
BEZ  
ZADRAPAN



**YATO**  
YT-0844 5/10

**YATO**  
YT-0847 L (mm) 265 6/36



3/4" (19 mm) 7/8" (22 mm) 1" (25 mm) 1.1/2" (37.5 mm)

SLIDING  
CARD



- GB Multiposition pry bar set  
D Steckschlüsselsatz mit regulierbaren Kopfstück  
PL Zestaw dźwigni z regulowaną główką

- RUS Комплект рычагов с регулируемой головкой  
CZ Sada páčidel s nastavitelnou hlavou  
H Szabályozható fejű emelőkar készlet

- RO Set de leviere cu cap reglabil  
E Juego de palancas con cabeza ajustable

3 PCS 10" 12" 15"  
22mm 250mm 300mm 380mm  
LOCK SYSTEM SYSTEM BLOKADY CrV



**YATO**  
YT-0616 10

BMC  
& COLOR  
SLEEVE



- GB Quick release cut out tool  
 D Schneidmesser für Scheiben  
 PL Nóż do wycinania szyb  
 RUS Нож для вырезания стекол  
 CZ Nůž na vyřezávání skel  
 H Szélvédőkivágó kés  
 RO Cuțit tăietor de geam  
 E Cuchilla para cortar cristales



**3x**  
BLADES  
OSTRZA

**Alu**  
HANDLE  
UCHWYTY

**QUICK**  
RELEASE  
SZYBKÓ-  
ZŁĄCZCE

**K5**

SLIDING  
CARD



- GB Spare blades for cut out tool  
 D Abbrechklingenn  
 PL Ostrza zapasowe do noża do wycinania szyb  
 RUS Лезва для ножей  
 CZ Ostří náhradní  
 H Törhető tartalékpenge  
 RO Rezerve cutter  
 E Filo partido de recambio



**3x**  
BLADES  
OSTRZA

**K5**

for / dla: YT-0659

SLIDING  
CARD



3/4" (19 mm);  
 1" (25 mm);  
 1-1/2" (38 mm)

|             |       |
|-------------|-------|
| <b>YATO</b> |       |
| YT-0659     | 20/40 |

|             |       |
|-------------|-------|
| <b>YATO</b> |       |
| YT-06590    | 10/80 |

- GB Windshield removal set  
 D Demontagesatz für Autoscheiben  
 PL Zestaw do demontażu szyb samochodowych  
 RUS Набор для демонтажа автостекла  
 CZ Souprava na demontáž autoskel  
 H Szélvédőcserélő szett  
 RO Set pt. demontarea geamurilor de mașină  
 E Juego para desmontaje de cristales de coches



COLOR BOX



**7**  
PCS

**HRC**  
38-42

|             |    |
|-------------|----|
| <b>YATO</b> |    |
| YT-0845     | 10 |

- GB Windscreen wiper arm removal tool  
 D Abziehvorrichtung für die Scheibenwischerarme  
 PL Ściągacz do ramion wycieraczek  
 RUS Съемник поводков стеклоочистителя  
 CZ Stahovák na ramínka stěračů  
 H Ablaktörökár lehúzó  
 RO Siguranță pt. brațele ștergătoarelor  
 E Herramienta para desmontaje de las plumas de los limpiaparabrisas

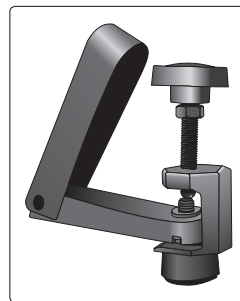

SLIDING  
CARD



|             |        |
|-------------|--------|
| <b>YATO</b> |        |
| YT-0846     | 12/120 |

16

- GB Air condition repair set  
 D Schlüsselsatz für die Klimatisierung  
 PL Zestaw kluczy do klimatyzacji  
 RUS Набор ключей для кондиционеров  
 CZ Sada klíčů na klimatizace  
 H Kulcskészlet légkondicionáléhoz  
 RO Set de chei pt. aer condiționat  
 E Juego de llaves para los sistemas de aire acondicionado



**12**  
PCS

**1/4"**

**S2**

**6.3**  
mm

**CrV**

**8 POINTS**  
**8 PUNKTÓV**

**FOR A/C**  
**DO KLIMA-**  
**TYZACJI**

1/4" (6.3 mm): 2.2 mm, 3.2 mm; CrV;

1/4" (6.3 mm): 12 mm, 15 mm; CrV;

1/4" (6.3 mm); CrV;

1/4" (6.3 mm): TS10, TS15, TS20, TS25, TS27, TS30, TS40; L=25 mm; AISI S2

BMC  
& COLOR  
SLEEVE



|             |       |
|-------------|-------|
| <b>YATO</b> |       |
| YT-06271    | 10/40 |

- GB** CV boot clamp pliers  
**D** Zange für Schellen der Gelenkabdeckung  
**PL** Szczyrce do opasek osłony przegubu  
**RUS** Щипцы для хомутов крепления кожуха шарнира  
**CZ** Kleště na spony manžety kloubu  
**H** Féltepengely bilincs húzó fogó  
**RO** Clește pt. brățară de husă la articulație  
**E** Alicates para abrazadera de protección de la junta

SLIDING CARD



235 mm

CrV

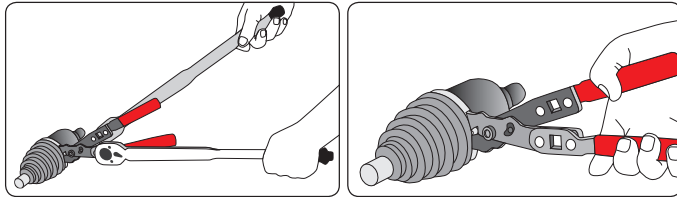

**YATO**  
YT-0606

L (mm)  
235

6/36

- GB** Lock-ring pliers  
**D** Spreizzange für Schellen  
**PL** Szczyrce rozporowe do pierścieni osadczyc  
**RUS** Щипцы распорные для стяжных хомутов  
**CZ** Kleště na hadicové spony  
**H** Seeger fogó  
**RO** Clește pt. desfacerea brățarelor de strângere  
**E** Alicates para abrazaderas

SLIDING CARD



225 mm

CrV

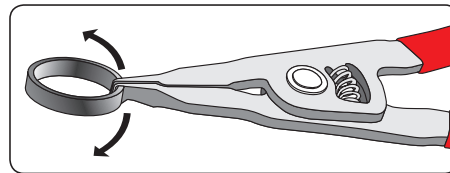

APPLICATION / ZASTOSOWANIE:



**YATO**  
YT-0607

L (mm)  
225

12/72

- GB** Fuel feed pipe pliers  
**D** Zange für Tankverschlüsse  
**PL** Szczyrce do złączek paliwowych  
**RUS** Щипцы для топливных соединений  
**CZ** Kleště na spojky palivového systému  
**H** Üzemanyagvezeték fogó  
**RO** Clește pt. conectoare de combustibil  
**E** Alicates para enchufes de combustible

SLIDING CARD



Al

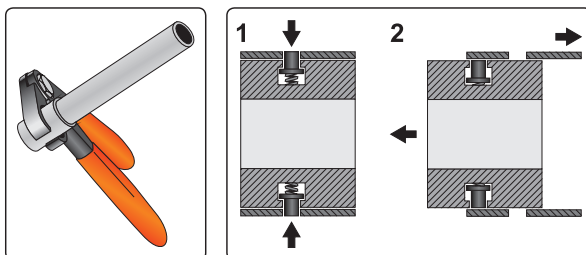

**YATO**  
YT-0608

10/40

- GB** Hose removing pliers  
**D** Schlauch- und Kabellösezange  
**PL** Szczyrce do zdejmowania przewodów  
**RUS** Клещи для снятия изляции  
**CZ** Kleště na demontáž hadic  
**H** Tömlőbilincs fogó  
**RO** Clește pt. indepartat furtune  
**E** Alicata de extracción de mangueras

SLIDING CARD



5-15 mm

5-30 mm



**YATO**  
YT-0657

6/36

- GB Transmission line disconnect tool set
- D Werkzeugsatz zum Trennen von Kraftstoffleitungen
- PL Zestaw do rozłączania przewodów
- RUS Набор для рассоединения топливopроводов
- CZ Sada na rozpojování palivového potrubí
- H Üzemanyagszó-lebontó készlet
- RO Set pt. deconectarea liniilor de combustibil
- E Juego para desconectar conductos de combustible



**8**  
PCS

**FOR A/C**  
DO KLIMATYZACJI

**FOR FUEL LINE**  
DO PRZEWODÓW PALIWA



BMC & COLOR SLEEVE

|             |    |
|-------------|----|
| <b>YATO</b> |    |
| YT-0630     | 20 |

- GB Spark plug terminal pliers
- D Zange für das Zündkerzenkabel
- PL Szczypce do przewodów świec zapłonowych
- RUS Щипцы к проводам свечей зажигания
- CZ Kleště na kabely zapalovacích svíček
- H Gyújtógyertya-kábel fogó
- RO Clește pt. conductele bujiilor de aprindere
- E Pinzas para los cables de las bujias de ignición



SLIDING CARD

**200**  
mm

**255**  
mm



|             |        |       |             |        |       |
|-------------|--------|-------|-------------|--------|-------|
| <b>YATO</b> | L (mm) |       | <b>YATO</b> | L (mm) |       |
| YT-0639     | 200    | 12/96 | YT-7320     | 255    | 10/60 |

- GB Multi-purpose hose & wire pliers
- D Zangensatz für Schellen und Leitungen
- PL Komplet szczypiec do opasek i przewodów
- RUS Набор щипцов к хомутам и проводам
- CZ Souprava kleští na spony a hadice
- H Fogókészlet bilincsekhez és vezetékekhez
- RO Set clește pt. benzi și conducte
- E Juego de pinzas para abrazaderas y cables

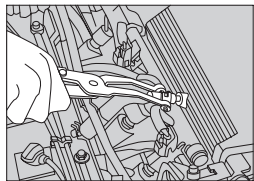

For engine air pipe  
Do przewodów powietrznych listwy wtryskowej

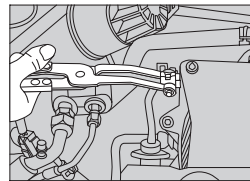

For engine intake air pipe  
Do przewodów gumowych układu zasilania

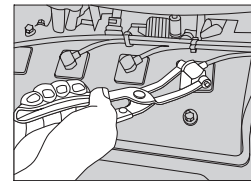

For spark plug lead  
Do przewodów zapłonowych

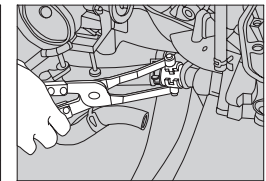

For cooling water pipe  
Do przewodów gumowych układu chłodzenia

**2**  
PCS

**1/4"-3/4"**

**6.3-19.0**  
mm

**217**  
mm

**254**  
mm



|             |            |      |
|-------------|------------|------|
| <b>YATO</b> | L (mm)     |      |
| YT-0645     | 217<br>254 | 6/24 |



GB Hose clamp pliers  
D Zange zum Entspannen der Klemmschellen  
PL Szczypce do opasek zaciskowych rozprężnych  
RUS Щипцы к хомутам зажимным распорным

CZ Kleště na samosvorné hadicové spony  
H Vízcsőbilincs fogó  
RO Clește pt. benzile de strângere destindere  
E Pinzas para las abrazaderas de expansión

SLIDING  
CARD



215  
mm



2mm

LOCK  
SYSTEM  
SYSTEM  
BLOKADY

ALLOY  
STEEL  
AISI 4130

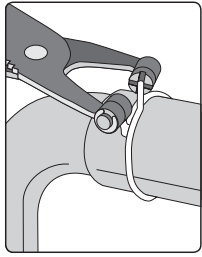

| YATO    | L (mm) |       |
|---------|--------|-------|
| YT-0646 | 215    | 12/72 |

GB Hose clamp pliers  
D Zange zum Entspannen der Klemmschellen  
PL Szczypce do opasek zaciskowych rozprężnych  
RUS Щипцы к хомутам зажимным распорным

CZ Kleště na samosvorné hadicové spony  
H Vízcsőbilincs fogó  
RO Clește pt. benzile de strângere destindere  
E Pinzas para las abrazaderas de expansión

SLIDING  
CARD



215  
mm



4.5mm

LOCK  
SYSTEM  
SYSTEM  
BLOKADY

ALLOY  
STEEL  
AISI 4130

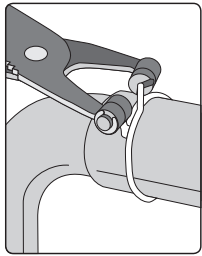

| YATO    | L (mm) |       |
|---------|--------|-------|
| YT-0647 | 215    | 12/72 |

GB Hose clamp pliers  
D Zange zum Entspannen der Klemmschellen  
PL Szczypce do opasek zaciskowych rozprężnych  
RUS Щипцы к хомутам зажимным распорным

CZ Kleště na samosvorné hadicové spony  
H Vízcsőbilincs fogó  
RO Clește pt. benzile de strângere destindere  
E Pinzas para las abrazaderas de expansión

SLIDING  
CARD



4mm

∅ 12mm

LOCK  
SYSTEM  
SYSTEM  
BLOKADY

HRC  
40

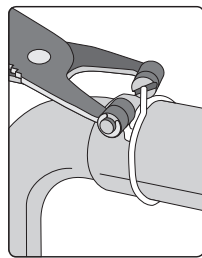

230  
mm

| YATO    | L (mm) |      |
|---------|--------|------|
| YT-0650 | 230    | 6/36 |



45°

215  
mm

| YATO    | L (mm) |      |
|---------|--------|------|
| YT-0651 | 215    | 6/36 |

GB Exhaust pipe clamp pliers  
D Auspuffschellen-Sicherungszange  
PL Szczypce do opasek wydechu  
RUS Щипцы для пружинных зажимов

CZ Kleště na spony výfuku  
H Kipufogóbilincs fogó  
RO Clește pt. coliere teava de esapament  
E Pinzas para bridas del tubo de escape

SLIDING  
CARD



300  
mm

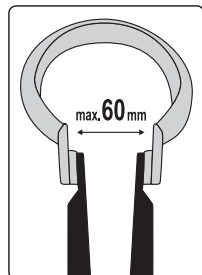

| YATO    | L (mm) |       |
|---------|--------|-------|
| YT-0652 | 300    | 10/40 |

for / dla: Peugeot, Citroën,  
Renault, Fiat, Ford

GB Valve stem seal pliers  
 D Lange Zange für Ventildichtringe  
 PL Szczypce do uszczelniaaczy zaworowych, długie  
 RUS Щипцы для замены маслоъемных колпачков

CZ Kleště na těsnění ventilů, dlouhé  
 H Szelepszár szimering fogó hosszú  
 RO Clește cu picior lung pt. sigilat supape  
 E Pinzas para juntas de vástago válvula

SLIDING CARD



270 mm

FOR VALVE STEM SEALS  
 DO USZCZELNIACZY ZAWOROWYCH

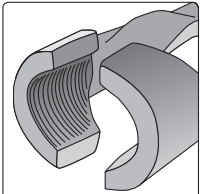

**NON-SLIP**



|             |        |       |
|-------------|--------|-------|
| <b>YATO</b> | L (mm) |       |
| YT-0648     | 270    | 12/60 |

GB Pliers for band clips with a cord  
 D Zange für Rohrschellen mit Seil  
 PL Szczypce z linką do opasek zaciskowych  
 RUS Щипцы к зажимным хомутом с тросиком  
 CZ Kleště s lankem na samosvorné hadicové spony

H Flexibilis bowdenes vízcsőbilincs fogó  
 RO Clește pt. cleme de prindere frânghie  
 E Pinzas para bandas de apretadura con cuerda

SLIDING CARD



CrMo 4140

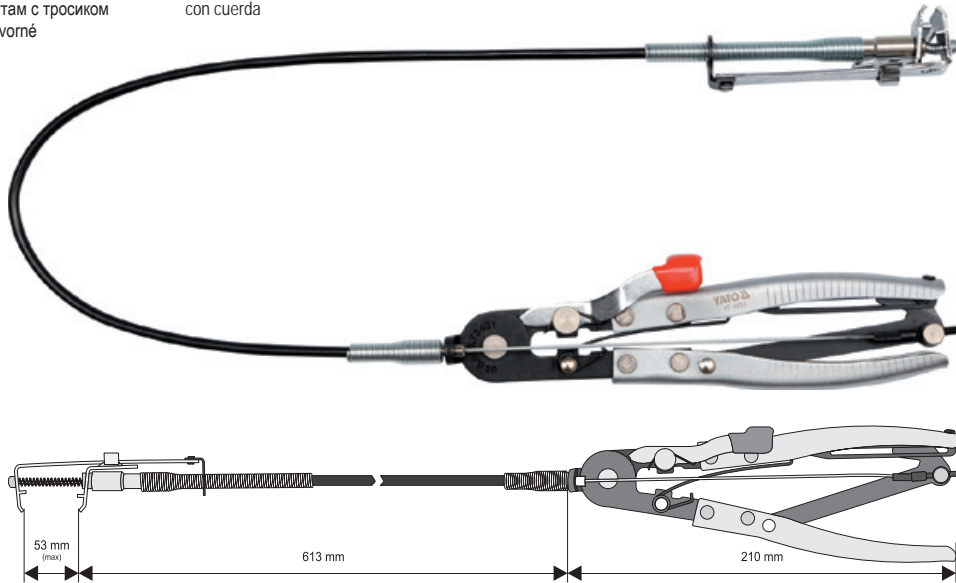

|             |       |
|-------------|-------|
| <b>YATO</b> |       |
| YT-0653     | 12/36 |

GB Pliers for band clips with a cord  
 D Zange für Rohrschellen mit Seil  
 PL Szczypce z linką do opasek zaciskowych  
 RUS Щипцы к зажимным хомутом с тросиком  
 CZ Kleště s lankem na samosvorné hadicové spony  
 H Flexibilis bowdenes vízcsőbilincs fogó  
 RO Clește pt. cleme de prindere frânghie  
 E Pinzas para bandas de apretadura con cuerda

SLIDING CARD



CrMo 4140

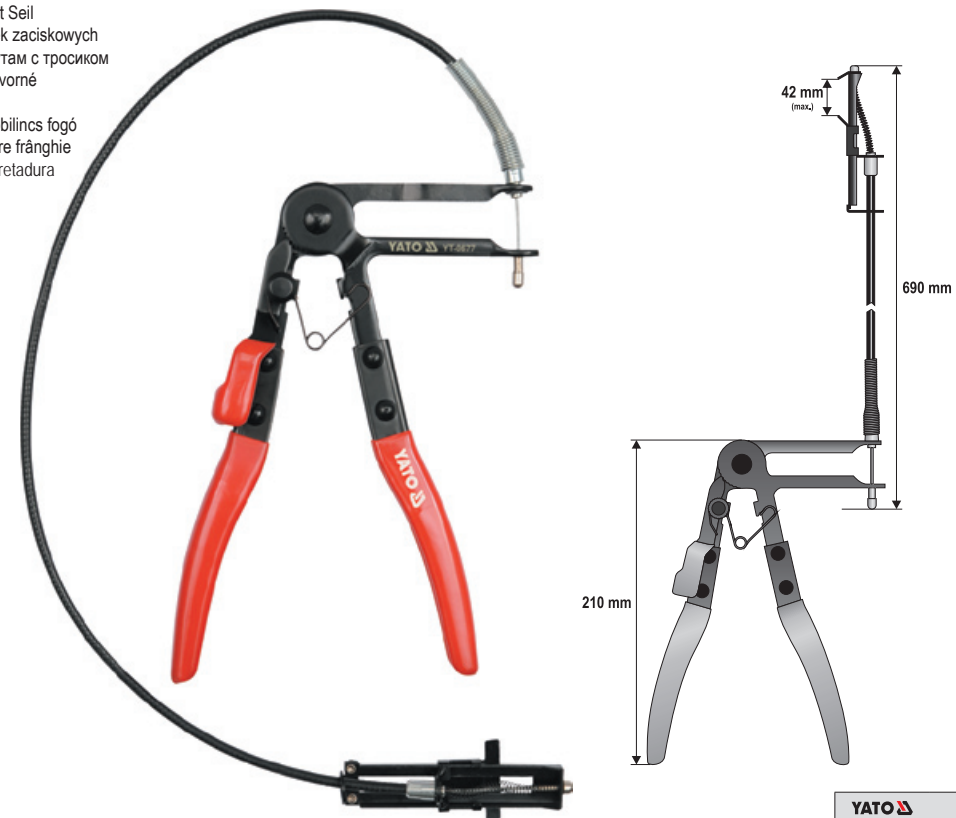

|             |    |
|-------------|----|
| <b>YATO</b> |    |
| YT-0677     | 25 |

GB Water pump pulley locking wrench  
D Schlüssel für die Wasserpumpe  
PL Klucz do pompy wodnej  
RUS Ключ к водному насосу

CZ Klič na vodní čerpadlo  
H Vizpumpafogó  
RO Cheie pt. pompe de apă  
E Llave para la bomba de agua

SLIDING  
CARD



245  
mm  
285  
mm

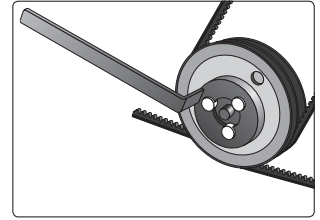
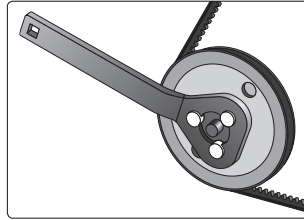

Volkswagen and Audi  
without air condition  
Volkswagen i Audi  
bez klimatyzacji



Volkswagen and Audi  
with air condition  
Volkswagen i Audi  
z klimatyzacją

| YATO    | L (mm) |      |
|---------|--------|------|
| YT-0539 | 245    | 6/36 |

| YATO    | L (mm) |      |
|---------|--------|------|
| YT-0540 | 285    | 6/36 |

GB Universal pulley holder & fan clutch set  
D Schlüssel zum Spannen  
der Riemenscheibe

PL Klucz do napinania koła pasowego  
RUS Ключ для натягивания шкива  
CZ Klič k napínání řemenice

H Szijtárcsa feszítő kulcs  
RO Cheie pt. întindere roată de curea  
E Llave tensora para polea



11  
PCS

BMC  
& COLOR  
SLEEVE

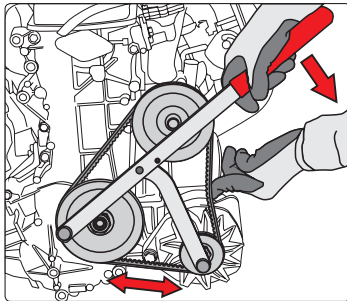

Ø 6-10 mm;  
Ø 8-11 mm;  
Ø 10-12 mm;  
Ø 11-16 mm

| YATO    |   |
|---------|---|
| YT-0627 | 8 |

GB Piston ring compressor  
D Kolbenring-Spannband  
PL Zaciskacz do pierścieni  
RUS Оправка поршневых колец

CZ Svěrka na kroužky  
H Gyűrűbepattintó  
RO Clește pt. strâns inele  
E Apretador de anillos

AISI  
# 301

SK5

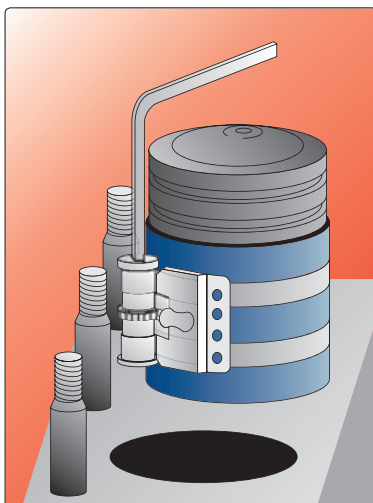

COLOR BOX



| YATO    | Ø (mm) | H (mm) |       |
|---------|--------|--------|-------|
| YT-0635 | 50-125 | 75     | 30/60 |
| YT-0636 | 90-175 | 100    | 30/60 |
| YT-0637 | 90-175 | 150    | 20/40 |

**GB** Twin cam locking tool for petrol & diesel engines  
**D** Universelle Blockade der Steuerwellen  
**PL** Uniwersalna blokada wałków rozrządu  
**RUS** Универсальный набор блокировки распредвала

**CZ** Univerzální přípravek na zablokování rozvodných hřídelí  
**H** Univerzális vezérműtengely rögzítő  
**RO** Blocadă universală arbore de direcție  
**E** Bloqueo universal de eje de distribución

FOR PETROL & DIESEL ENGINES  
 DO SILNIKÓW DIELSIA  
 I BENZYNOWYCH

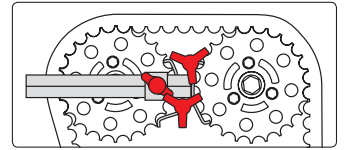

SLIDING CARD

|             |       |
|-------------|-------|
| <b>YATO</b> |       |
| YT-06011    | 10/20 |

**GB** Camshaft locking tool  
**D** Nockenwellen-Arretierwerkzeug  
**PL** Przyrząd do blokowania kół rozrządu  
**RUS** Инструмент для блокирования распределительных механизмов  
**CZ** Přípravek k montáži rozvodových kol  
**H** Vezérlés rögzítő szerszám  
**RO** Arbore cu came  
**E** Aparato para bloquear el árbol de levas



48 mm

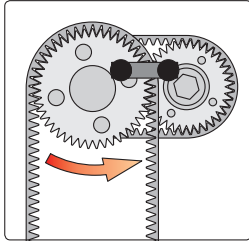

VW Lupo since 1999  
 VW Polo since 1995  
 VW Caddy since 1996  
 VW Polo Classic since 1996  
 VW Polo Variant since 1996  
 VW New Beetle 1.4 l  
 VW Golf 1.4 l, 1.6 l since 1998  
 VW Bora 1.4 l, 1.6 l since 1999

**GB** Diesel engine locking setting kit  
**D** Blockade für die Stellräder  
**PL** Blokada do kół rozrządu  
**RUS** Блокировка к колесам распределительных механизмов

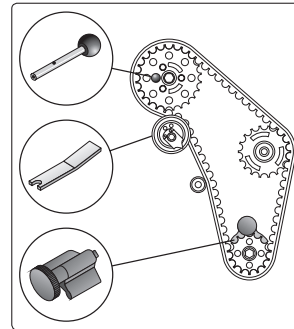

**VW:** Lupo, Polo, Golf / Bora, Beetle, Caddy, Sharan, Touran, Transporter (1998-2006);  
**AUDI:** A2, A3, A4, A6;  
**FORD:** Galaxy (2000-2006);

**CZ** Souprava na fixaci rozvodových kol  
**H** Diesel motor rögzítő készlet  
**RO** Blocadă roțiilor distribuție  
**E** Bloqueo para las poleas del mecanismo de distribución



**SEAT:** Arosa, Ibiza, Cordoba, Leon, Toledo, Alhambra (1999-2005);  
**SKODA:** Fabia, Octavia (2000-2006)  
**3 i 4 cyl 1.2, 1.4, 1.9 TDI PD  
 2.0 SDI, 2.0 TDI PD**

3 PCS

FOR VALVETRAIN DO UKLADU ROZRZADU

SLIDING CARD



|             |      |
|-------------|------|
| <b>YATO</b> |      |
| YT-0601     | 6/36 |

|             |       |
|-------------|-------|
| <b>YATO</b> |       |
| YT-0632     | 10/50 |

**GB** Timing locking set  
**D** Arretierwerkzeugsatz für Nockenwellen  
**PL** Zestaw blokad rozrządu  
**RUS** Набор блокировок к колесам распределительных механизмов  
**CZ** Blokovací sada pro opravy rozvodů  
**H** Vezérműrögzítő szerszámkészlet  
**RO** Set blocare distributie auto  
**E** Juego de bloqueos de distribución



8 PCS

AI

BMC & COLOR SLEEVE

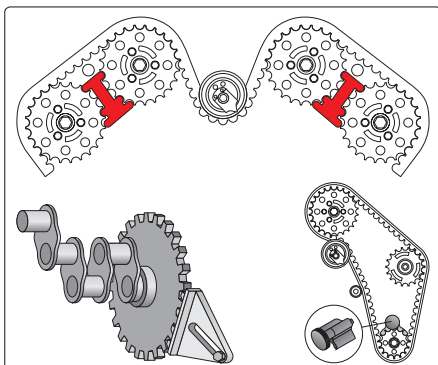

| <b>YATO</b> | No.   | No. |   |
|-------------|---|-----|---|
| YT-0633     | <b>Vauxhall/Opel:</b> ASTRA G 1.7 TD, ASTRA G 2.0 16V, VECTRA 1.8/2.0 16V > 1995  |     | <b>Volkswagen:</b> BORA 1.9TDI, GOLF 1.9TDI, LUPO 1.2/1.4/3.0 TDI, POLO 1.4TDI PASSAT 1.9TDI  |
|             | <b>Vauxhall/Opel:</b> ASTRA G 1.4/1.6/1.8 16V > 1994, VECTRA 1.6/1.8 16V, ZAFIRA 1.6/1.8 16V  |     | <b>Citroen:</b> BERLINGO 1.9D, DISPATCH 1.9D/TD-FSO 1.9D, RELAY 1.9D/TD, SYNERGIE 1.9/2.0T, SANTIA 1.9/2.0 D/TD/HDI, XSARA 1.9/2.0 DI/HDI, ZX 1.9D/TD, most diesels<br><b>Fiat:</b> DUCATO 2.0D, ULYSSE 1.8/2.0 TURBO<br><b>Ford:</b> most diesels<br><b>Peugeot:</b> 205 1.6/1.8/1.9D, 305 1.6/1.8/1.9D, 306 1.8/1.9D/TD, 309 1.6/1.9D-4.5 1.6/1.9D, 406 1.9D, 605 2.0D/TD, 806 1.9TD,<br><b>Boxer:</b> 1.9/2.0 DI/TD, EXPERT 1.9D, PARTNER 1.9D<br><b>Talbot:</b> EXPRESS D, HORIZON D-J5 D, SOLARA D |
|             | right hand camshaft<br><b>Vauxhall/Opel:</b> CALIBRA 2.5/2.5i/2.6 V6, CAVALIER 2.5i V6, OMEGA B 2.5/2.6/3.0/3.2 V6, SINTRA 3.0 V6, VECTRA A 2.5i/2.6 V6                         |     |   |
|             | left hand camshaft<br><b>Saab:</b> 900-9000<br><b>Vauxhall/Opel:</b> CALIBRA 2.5/2.5i/2.6 V6, CAVALIER 2.5i V6, OMEGA B 2.5/2.6/3.0/3.2 V6, SINTRA 3.0 V6, VECTRA A 2.5i/2.6 V6 |     |   |
|             | <b>Rover:</b> 25 1.4/1.6/1.8/VVC, 45 1.4/1.6/1.8, 75 1.8, 200 VI, 214 16V, 216 16V/CABRIO/COUPE, 218 COUPE, 414 16V, 416 16V, BRM 1.8VVC  |     | <b>Isuzu:</b> 1.5/1.7 diesel engines<br><b>Vauxhall/Opel:</b> 1.6/1.7 diesel engines, 1.2/1.4/1.6/1.8/2.0 OHC petrol engines  |

16

- GB Diesel injector puller  
D Stoßabziehvorrichtung für Einspritzdüse  
PL Ściągacz bezwładnościowy do wtryskiwaczy  
RUS Ударный съемник форсунок  
CZ Rázový vyťahovač vstříkovačů  
H Diesel porlasztó kisedő  
RO Dispozitiv de scos injectoare  
E Tuerca tensora de impacto para inyectoros

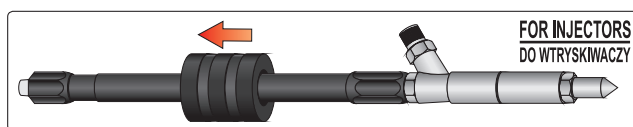

FOR INJECTORS  
DO WTRYSKIWACZY

BOSCH TYPE  
LUCAS TYPE  
M8  
M12  
M14



BMC & COLOR SLEEVE



**YATO**  
YT-0617 20

- GB Overhead valve spring compressor  
D Vorrichtung zur Demontage von Motorventilen  
PL Prząd do demontażu zaworów silnikowych  
RUS Устройство для демонтажа клапанов двигателя  
CZ Přípravek na demontáž ventilů motoru  
H Szeleplehúzó készülék  
RO Dispozitiv pt. demontarea supapelor la motoare  
E Instrumento para desmontaje de válvulas de motor

SLIDING CARD



- GB Lambda sensor thread chaser  
D Lambdasonde gewinde reparatur-set  
PL Zestaw do naprawy gwintów sondy lambda  
RUS Набор для ремонта сорванной резьбы винтов  
CZ Sada na opravu závitů Lambda sondy  
H Menetjavító készlet Lambda szondához  
RO Dispozitiv pt. curatat filet sonda lambda  
E Cazador del hilo de rosca para sonda lambda

FOR OXYGEN SENSOR DO SONDY LAMBDA  
HRC 50

M12 x 1.25  
M18 x 1.5



**YATO**  
YT-1756 12/96

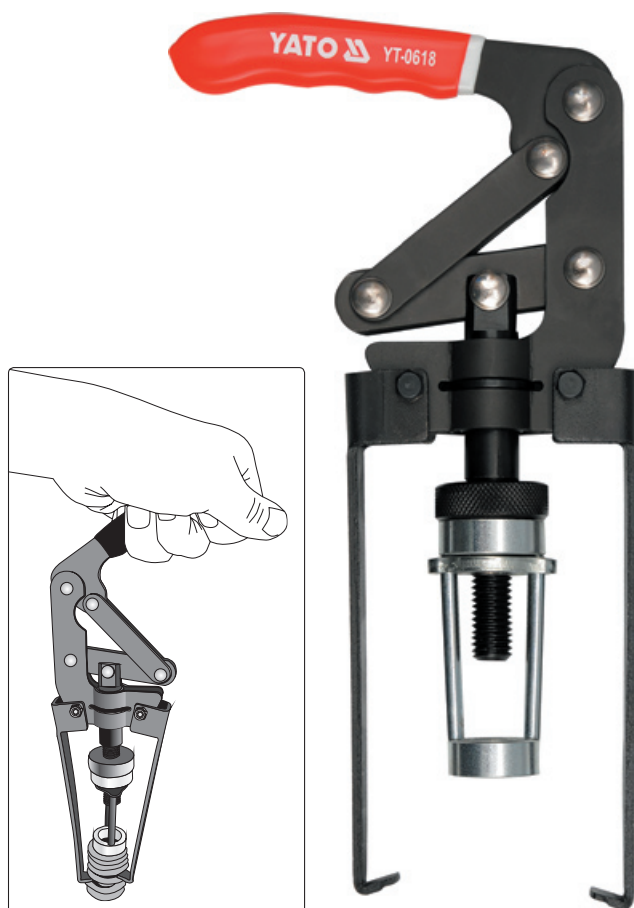

- GB Oxygen sensor crowfoot wrench  
D Schlüssel für die Lambdasonde  
PL Klucz do sondy lambda  
RUS Ключ для зонда лямбда  
CZ Klíč na sondu lambda  
H Lambda szonda kulcs  
RO Cheie pt. sonda lambda  
E Llave para la sonda lambda

SLIDING CARD



22 mm  
FOR OXYGEN SENSOR DO SONDY LAMBDA



CrMo SCM-440

**YATO**  
YT-1753 60



CrV 50BV30

**YATO**  
YT-1754 6/36

- GB Socket and oxygen sensor set  
D Steckschlüssel für die Lambda-Sonde  
PL Klucze nasadowe do sondy lambda  
RUS Торцовые ключи с внутренним многогранником для зонда лямбда  
CZ Nástrčné klíče na sondy lambda  
H Dugókulcs lambda szondához  
RO Prize pt. sonda slambda  
E Llaves de cubo para la sonda lambda



3 PCS  
22 mm  
FOR OXYGEN SENSOR DO SONDY LAMBDA

CrMo SCM-440  
CrV 50BV30

BMC & COLOR SLEEVE



**YATO**  
YT-1752 20

- 22 mm; L=50 mm; 6PT; CrMo SCM440;  
 22 mm; L=30 mm; 6PT; CrMo SCM440;  
 22 mm; L=80 mm; 6PT; CrV 50BV30

- GB** Oxygen sensor and fuel injectors wrench set  
**D** Steckschlüsselsatz für die Lambdasonde und die Einspritzdüsen  
**PL** Zestaw nasadek do sondy lambda i wtryskiwaczy  
**RUS** Набор насадок клямбда-зондам и форсункам  
**CZ** Sada nástavců na demontáž sondy lambda a vstříkovačů  
**H** Dugókészlet lambda szondákhoz és injektorokhoz  
**RO** Set inelare pt. sonda lambda și injectoare  
**E** Juego de boquillas para la sonda lambda y para inyectoros



|  |  |          |
|--|--|----------|
| 7<br>PCS                                 | 1/2"                                       | 3/8"     |
| CrMo<br>SCM440                           | 12.5<br>mm                                 | 10<br>mm |
| CrV<br>50BV30                            | FOR OXYGEN<br>SENSOR<br>DO SONDY<br>LAMBDA |          |
| FOR FUEL INJECTORS<br>DO WTRYSKÓW PALINA |  |          |

- 1/2" (12.7 mm) x 29 mm; L=90 mm; 6PT;
- 3/8" (9.5 mm) x 22 mm; L=90 mm; 6PT;
- 1/2" (12.7 mm) x 27 mm; L=78 mm; 12PT;
- 3/8" (9.5 mm) x 27 mm; L=74 mm; 6PT;
- 3/8" (9.5 mm) x 22 mm; L=80 mm; 6PT;
- 1/2" (12.7 mm) x 22 mm; L=50 mm; 6PT;
- 3/8" (9.5 mm) x 22 mm; L=30 mm; 6PT



BMC & COLOR SLEEVE

| YATO    | size / rozmiar |    |
|---------|----------------|----|
| YT-1751 | 1/2" (12.7 mm) | 10 |
|         | 3/8" (9.5 mm)  |    |

- GB** Diesel injection socket set  
**D** Aufsätze für die Einspritzungen bei Dieselmotoren  
**PL** Zestaw nasadek do wtrysków w silnikach Diesla  
**RUS** Набор насадок к форсункам в дизельных двигателях  
**CZ** Sada nástavců na trysky dieselových motorů  
**H** Szerszámkészlet Dieselmotor befecskendezőkhöz  
**RO** Set de capete pt. injectoare în motoare Diesel  
**E** Juego de tapones para las inyecciones en los motores de Diesel



|  |      |          |
|--|------|----------|
| 6<br>PCS                                 | 1/2" | AS-DRIVE |
| 12.5<br>mm                               | CrV  |          |
| FOR FUEL INJECTORS<br>DO WTRYSKÓW PALINA |      |          |



BMC & COLOR SLEEVE

| YATO    | size / rozmiar |    |
|---------|----------------|----|
| YT-0622 | 1/2" (12.7 mm) | 10 |

21x90; 22x78; 22x110; 27x78; 28x78; 28x83 mm

16

- GB** Tooth socket for injection nozzle  
**D** Stiftschlüsselsatz für die Einspritzdüse in Lastkraftwagen  
**PL** Zestaw kluczy czopowych do wtryskiwaczy w samochodach ciężarowych  
**RUS** Набор шиповых ключей к форсункам грузовых автомобилей  
**CZ** Sada klíčů na vstříkovače pro nákladní automobily  
**H** Csaposkulcs készlet tehergépkocsi befecskendezőjéhez  
**RO** Set chei tubulare cu ungera pt. camioane  
**E** Juego de llaves de muñon para los inyectoros en camiones



|  |      |     |
|--|------|-----|
| 4<br>PCS                                 | 1/2" | HEX |
| 12.5<br>mm                               | CrMo |     |
| S45C                                     | CrV  |     |
| FOR FUEL INJECTORS<br>DO WTRYSKÓW PALINA |      |     |



BMC & COLOR SLEEVE

| YATO    | size / rozmiar |    |
|---------|----------------|----|
| YT-1762 | 1/2" (12.7 mm) | 16 |

- 1/2" (12.7 mm); L=72 mm; 4T; CrV;
- 32 mm; M14 x 1.5 mm; L=70 mm, 4T; S45C;
- 1/2" (12.7 mm); L=120 mm; 3T; CrMo;
- 32 mm; L=120 mm, 4T; S45C

GB Fuel injection test kit  
D Diagnosesatz für die Prüfung der Kraftstoffeinspritzung  
PL Zestaw diagnostyczny do wtrysku paliwa  
RUS Пневматический набор к тормозным зажимам  
CZ Souprava k diagnostice vstřikování paliva

H Diagnosztikai készlet üzemanyag - befecskendőzökhöz  
RO Ansamblu pt. diagnosticarea injectiei combustibilului  
E Juego de herramientas diagnosticas para la inyección de combustible

10  
PCS

P<sub>max.</sub>  
0.7 MPa

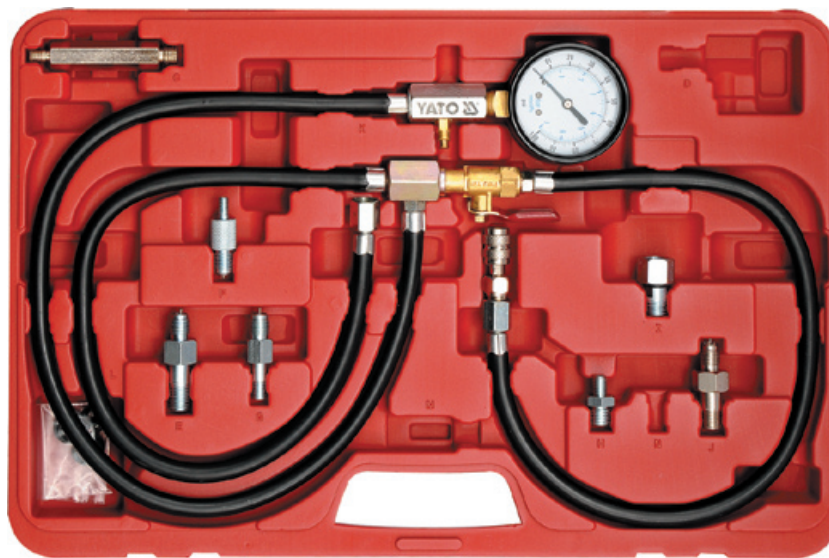

BMC  
& COLOR  
SLEEVE



|             |    |
|-------------|----|
| <b>YATO</b> |    |
| YT-0670     | 10 |

GB Compression pressure gauge in a diesel engine  
D Kompressionsdruckmesser in Dieselmotoren  
PL Miernik ciśnienia sprężania w silnikach diesla  
RUS Измеритель давления компрессии в дизельных двигателях  
CZ Souprava k měření kompresních tlaků v dieselových motorech

H Dieselmotorok kompresszióját mérő óra  
RO Manometrul presiunii aerului comprimat pt. motoarele diesel  
E Medidor de presión de la compresión en los motores diesel

16  
PCS

70 bar  
max.

FOR DIESEL  
ENGINE  
DO SILNIKŮV  
DIESLA

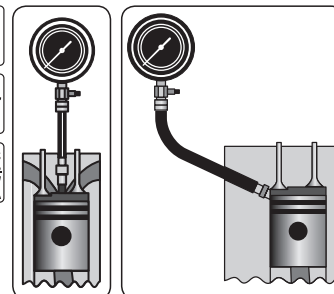

70 bar, 500 mm;

160 mm;

M20x1.5: 75 mm; M22x1.5: 73 mm; M24x1.5: 88 mm; M24x2: 63 mm;

M10x1: 83, 91, 102, 113, 119 mm; M10x1.25: 64, 135 mm; M12x1.25: 47 mm; M22x1.5: 118 mm;



BMC  
& COLOR  
SLEEVE



|             |   |
|-------------|---|
| <b>YATO</b> |   |
| YT-7307     | 5 |

GB Compression tester  
D Druckluftmessgerät  
PL Miernik ciśnienia sprężania

RUS Тестер компрессии  
CZ Měřicí přístroj  
kompresního tlaku

H Kompresszió mérő  
RO Aparat de măsurarea presiunii  
E Medidor de compresión

**FOR ALL TYPES**  
DO WSZYSTKICH TYPOW

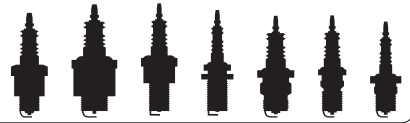

21 bar max.

FOR SPARK IGNITION DO ZAPŁONU ISKROWEGO

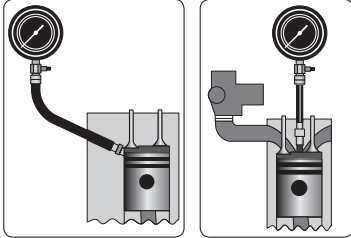

BMC & COLOR SLEEVE

RUBBER ADAPTOR ZŁĄCZE GUMOWE



THREADED ADAPTOR ZŁĄCZE GWINTOWANE



THREADED ADAPTOR ZŁĄCZE GWINTOWANE

RUBBER ADAPTOR ZŁĄCZE GUMOWE



|             |       |
|-------------|-------|
| <b>YATO</b> |       |
| YT-7300     | 24/48 |

|             |       |
|-------------|-------|
| <b>YATO</b> |       |
| YT-7301     | 12/24 |

|             |      |
|-------------|------|
| <b>YATO</b> |      |
| YT-7302     | 6/24 |

GB Flow meter common rail adapter set  
D Überlauf-Diagnosesatz für die Einspritzdüse Common rail  
PL Przelewowy zestaw diagnostyczny do wtryskiwaczy common rail  
RUS Диагностический набор к форсункам common rail; переливной  
CZ Souprava na diagnostiku vstřikovačů common rail, průtoková  
H Diagnosztikai készlet common rail injektorokhoz, átfolyós  
RO Set diagnostic preaplin pt. injectoare common rail  
E Juego diagnóstico de flujo para inyectoros common rail

31 PCS

FOR 6 CYLINDERS DO 6 CYLINDRÓW

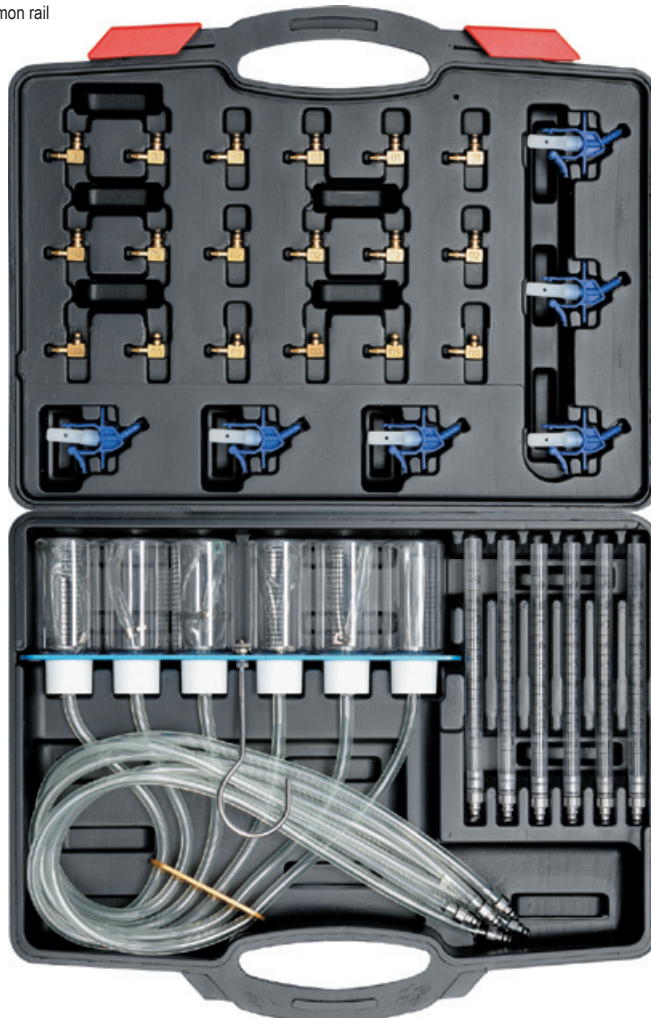

BMC & COLOR SLEEVE



|             |   |
|-------------|---|
| <b>YATO</b> |   |
| YT-7306     | 5 |

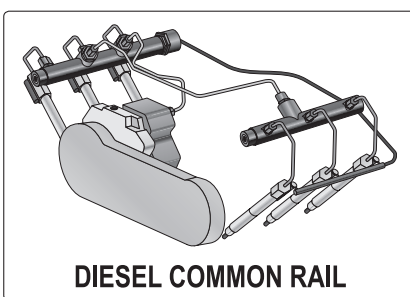



GB Combined sockets for alternator  
D Werkzeugsatz für Lichtmaschine  
PL Zestaw do alternatorów ze sprzęgłem  
RUS Набор для альтернатора

CZ Souprava na opravu alternátorů  
H Generátor szerszámkészlet  
RO Garnitură pt. alternator  
E Enchufes combinados para alternador

|            |              |      |              |               |              |
|------------|--------------|------|--------------|---------------|--------------|
| 13<br>PCS  | 1/2"         | HEX  | TORX         | SPLINE        | CrV          |
| 12.5<br>mm | HRC<br>40-44 | S45C | HRC<br>38-42 | STEEL<br>8660 | HRC<br>53-57 |

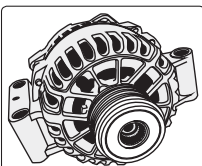

**FOR ALTERNATORS  
DO ALTERNATORÓW**

- 1/2" (12.7 mm): M10, HBS, 33T, L=110 mm; CrV; HRC 40-44;
- 1/2" (12.7 mm): T50, HBS, 33T, L=110 mm; CrV; HRC 40-44;
- M8, M10, L=75 mm; 8660; HRC 53-57;
- T40, T50, L=75 mm; 8660; HRC 53-57;
- H8, H10, L=75 mm; 8660; HRC 53-57;

- H15, 33T, L=30 mm; CrV; HRC 40-44;
- H22, 33T, L=30 mm; CrV; HRC 40-44;
- H22, L=30 mm; S45C; HRC 38-42;
- Ø 35 x 30 mm; CrV; HRC 40-44;
- 1/2" (12.7 mm) x 10 mm; CrV; HRC 40-44



|             |                |    |
|-------------|----------------|----|
| <b>YATO</b> | ○              | ☐  |
| YT-0421     | 1/2" (12.7 mm) | 15 |

GB Combined sockets for alternator  
D Werkzeugsatz für Lichtmaschine  
PL Zestaw do alternatorów ze sprzęgłem  
RUS Набор для альтернатора

CZ Souprava na opravu alternátorů  
H Generátor szerszámkészlet  
RO Garnitură pt. alternator  
E Enchufes combinados para alternador

|              |               |              |              |      |              |
|--------------|---------------|--------------|--------------|------|--------------|
| 22<br>PCS    | 1/2"          | 3/8"         | HEX          | TORX | SPLINE       |
| 12.5<br>mm   | 10<br>mm      | CrV          | HRC<br>40-44 | S45C | HRC<br>38-42 |
| HRC<br>38-42 | STEEL<br>8660 | HRC<br>53-57 |              |      |              |

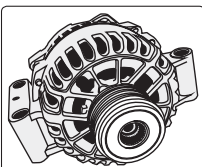
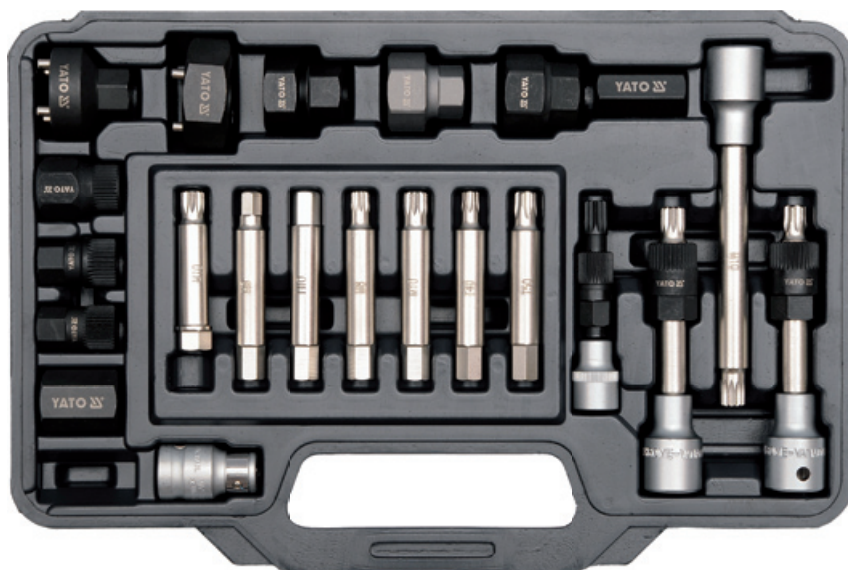

**FOR ALTERNATORS  
DO ALTERNATORÓW**

- 1/2" (12.7 mm): M10, HBS, 33T, L=113 mm; CrV; HRC 40-44 / 8660; HRC 53-57;
- 1/2" (12.7 mm): T50, HBS, 33T, L=113 mm; CrV; HRC 40-44 / 8660; HRC 53-57;
- 3/8" (10 mm): M10, HBS, 33T; L=80 mm; CrV; HRC 40-44 / 8660; HRC 53-57;
- 1/2" (12.5 mm): M10, HBS, 33T; L=140 mm; CrV; HRC 40-44;
- M8, M10, L=75 mm; 8660; HRC 53-57;
- T40, T50, L=75 mm; 8660; HRC 53-57;

- H8, H10, L=75 mm; 8660; HRC 53-57;
- M8xH12, L=64 mm; 8660; HRC 53-57;
- H15, 33T, Ø 17 mm, L=30 mm, H15, 33T, Ø 19 mm, L=30 mm, H22, 33T, Ø 19 mm, L=30 mm; CrV; HRC 40-44;
- H17, H22, L=30 mm; S45C; HRC 38-42;
- Ø 35 x 30 mm; S45C; HRC 38-42;
- Ø 38 mm; S45C; HRC 38-42;
- H19x28, H21x28, H22x28; S45C; HRC 38-42;
- 1/2" (12.5 mm) (F) x H10 mm (F); CrV; HRC 40-44



|             |                |               |    |
|-------------|----------------|---------------|----|
| <b>YATO</b> | ○              | ○             | ☐  |
| YT-04211    | 1/2" (12.7 mm) | 3/8" (9.5 mm) | 10 |

GB Stroboscopic tube  
 D Stroboskoplampe  
 PL Lampa stroboskopowa  
 RUS Стробокопная лампа  
 CZ Stroboskopická lamp  
 H Stroboszkóp lámpa  
 RO Lampă stroboscopică  
 E Tubo estroboscópico

12V  
 ENGINE SPEED  
 PREȚUTĂ CĂRĂȘI  
 8000 min<sup>-1</sup>  
 max.  
 XENON  
 DOUBLE  
 BLISTER

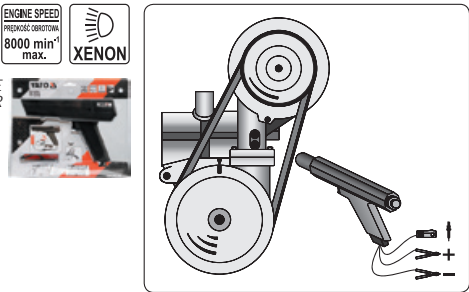

0-60°

|                        |      |                        |      |                        |      |
|------------------------|------|------------------------|------|------------------------|------|
| <b>YATO</b><br>YT-7310 | 6/12 | <b>YATO</b><br>YT-7311 | 6/12 | <b>YATO</b><br>YT-7312 | 6/12 |
|------------------------|------|------------------------|------|------------------------|------|

GB Universal radiator pressure kit  
 D Diagnosekit für Kühler  
 PL Zestaw diagnostyczny do chłodnicy  
 RUS Диагностический набор к радиатору  
 CZ Souprava k diagnostice chladiče

H Diagnosztikai készlet hűtőkhöz  
 RO Ansamblu pt. diagnosticarea radiatorului  
 E Juego de herramientas diagnosticas para el radiador

14  
 PCS  
 P max.  
 0.25 MPa  
 200°C  
 max.

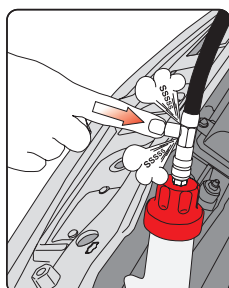
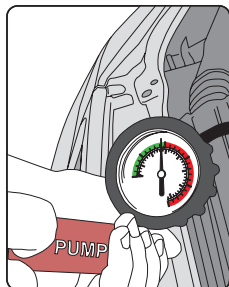
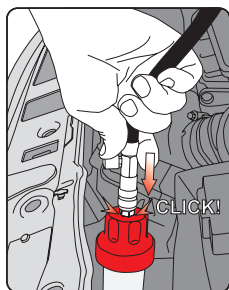

| YATO No. | No. |   |   |
|----------|-----|---|---|
| YT-0672  | 2   | General Motors  | 4 |
|          | 3   | Mercedes, General Motors, Jeep  |   |
|          | 4   | Peugeot, Subaru, Chrysler, Acura, General Motors, Mitsubishi, Nissan, Mazda, Toyota, Infiniti, GEO, Suzuki, Isuzu, Ford |   |
|          | 5   | Honda, Toyota, Suzuki, Mitsubishi, Chrysler, Acura  |   |
|          | 6   | Audi, BMW, Volkswagen, Porsche  |   |
|          | 7   | Volvo, Saab, Citroen, Renault, Fiat, Alfa Romeo, Jeep   |   |
|          | 8   | Volkswagen  |   |
|          | 9   | Mercedes, General Motors, Jeep  |   |
|          | 10  | BMW   |   |
|          | 11  | Audi, Volkswagen  |   |
|          | 12  | Ford, Land Rover, Opel, Jaguar, Mercedes  |   |
|          | 13  | Mercedes  |   |

- GB Hand-held vacuum pump  
D Unterdruckpumpe mit Zubehör  
PL Pompka podciśnieniowa z akcesoriami  
RUS Насос вакуумметрического давления с принадлежностями  
CZ Podtlaková pumpa s příslušenstvím  
H Vákuum- és ac-pumpa mérő, tartozékokkal  
RO Pompa de vidare cu accesorii  
E Bomba de subpresión con accesorios



16 PCS  
-1÷0 bar



**YATO**  
YT-0673 10

- GB Hand-held vacuum pump  
D Unterdruck-druckpumpe mit Zubehör  
PL Pompka ciśnieniowo-podciśnieniowa z akcesoriami  
RUS Насос вакуумметрического давления с принадлежностями  
CZ Podtlaková-tlaková pumpa s příslušenstvím  
H Vákuum- és ac-pumpa mérő, tartozékokkal  
RO Pompa de vidare cu accesorii  
E Bomba de subpresión-presión con accesorios



22 PCS  
-1÷3 bar



**YATO**  
YT-0674 5

- GB Flexible line clamp  
D Schlauchklemmsatz  
PL Komplet zacisków do przewodów z cieczą  
RUS Набор зажимов с фиксатором  
CZ Sada hadicových svěrek  
H Flexibilis cső elszorító készlet  
RO Clema flexibilă  
E Juego de alicates apretadores para conductos de líquidos

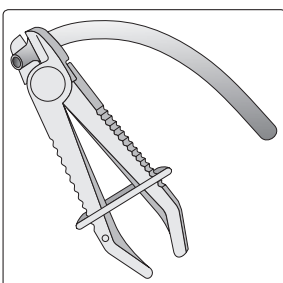

1/4" - 3/4"



1/2" - 5/4"



3/4" - 9/4"



1/4" - 3/4" for brake and fuel lines  
6.3 - 19.0 mm do przewodów hamulcowych i paliwowych

1/2" - 5/4" for flexible hose  
12.5 - 32.0 mm do przewodów elastycznych

3/4" - 9/4" for radiator hose clamp  
19.0 - 57.0 mm do przewodu chłodnicy

3 PCS

WILL NOT CUT HOSES  
NIE NISZCZY PRZEWODÓW

NON-CONDUCTIVE  
NIEPRZEWODZĄCE



SLIDING CARD

**YATO**  
YT-0840 25/50

- GB Spark plug socket
- D Steckschlüssel mit Gummihalterung
- PL Nasadka do świecek
- RUS Головка свечная
- CZ Nastavec pro svíčky
- H Gyújtógyertya toldalék
- RO Cheie de buji
- E Boquilla de bujías

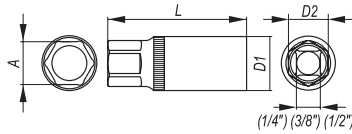

3/8"
10 mm
1/2"
12.5 mm
AS-DRIVE
DIN 3121
CrV 50BV30

COLOR BOX



\* - product not for european market  
 \* - produkt nieprzeznaczony na rynek europejski

| YATO     | Ø             | A    | D1 (mm) | D2 (mm) | L (mm) | PCS packing | Box    |
|----------|---------------|------|---------|---------|--------|-------------|--------|
| YT-3851  | 3/8" (9.5 mm) | 16.0 | 22.0    | 19.0    | 64.0   | 10          | 50/100 |
| YT-3852* | 3/8" (9.5 mm) | 21.0 | 27.8    | 22.0    | 64.0   | 10          | 50/100 |

| YATO    | Ø              | A    | D1 (mm) | D2 (mm) | L (mm) | PCS packing | Box    |
|---------|----------------|------|---------|---------|--------|-------------|--------|
| YT-1253 | 1/2" (12.7 mm) | 16.0 | 22.0    | 19.0    | 64.0   | 10          | 50/100 |
| YT-1254 | 1/2" (12.7 mm) | 21.0 | 27.8    | 24.0    | 64.0   | 10          | 50/100 |

- GB T-type universal joint spark plug socket set
- D Kerzenschlüssel mit Verlängerungshebel
- PL Klucz do świecek z przedłużką
- RUS Ключ к свечам с удлинителем
- CZ Klíč na svíčky s prodlužovacím nástavcem
- H Gyertyakulcs hosszabbítóval
- RO Cheie cu prelungitor, pt. buji
- E Llave para las bujías con extensión



4 PCS
16 mm
21 mm

AS-DRIVE
250 mm
CrV 6140
CrV 50BV30



PLASTIC HANGER

| YATO    | Box   |
|---------|-------|
| YT-0815 | 10/20 |

- GB Spark plug socket
- D Kerzenschlüssel mit Verlängerungshebel
- PL Klucz do świecek z przedłużką
- RUS Ключ к свечам с удлинителем

- CZ Klíč na svíčky s prodlužovacím nástavcem
- H Gyertyakulcs hosszabbítóval
- RO Cheie cu prelungitor, pt. buji
- E Llave para las bujías con extensión



3/8" (10 mm) x 300 mm
CrV 50BV30

PLASTIC HANGER

| YATO    | Ø (mm) | Box   |
|---------|--------|-------|
| YT-0817 | 16     | 10/40 |
| YT-0818 | 18     | 10/40 |
| YT-0819 | 21     | 10/40 |

- GB Bi-hexagonal spark plug socket
- D Zwölfkant-Kerzenschlüssel mit Verlängerungshebel
- PL Klucz do świecek dwunastokątny z przedłużką

- RUS Ключ к свечам с удлинителем
- CZ Klíč dvanáctihranný na svíčky s prodlužovacím nástavcem
- H Gyertyakulcs hosszabbítóval, 12 lapú

- RO Cheie cu prelungitor, bihexagonala, pt. buji
- E Llave bihexagonal para las bujías con extensión



3/8" (10 mm) x 300 mm
CrV 50BV30

PLASTIC HANGER

| YATO    | Ø (mm) | Box   |
|---------|--------|-------|
| YT-0812 | 14     | 10/40 |

- GB Joined glow plug socket set
- D Schlüsselsatz für Glühkerzen
- PL Zestaw kluczy do świecek żarowych
- RUS Набор ключей к калильным свечам
- CZ Sada klíčů na žhavičky
- H Gyertyakulcs készlet
- RO Set chei pt. buji incandescente
- E Juego de llaves para bujías incandescentes



6 PCS
3/8"
10 mm

BLOCKING SYSTEM SYSTEM BLOKOWĄCY
CrV 50BV30

8, 9, 10, 12, 14, 16 mm

BMC & COLOR SLEEVE



| YATO    | Ø             | Box |
|---------|---------------|-----|
| YT-0534 | 3/8" (9.5 mm) | 10  |

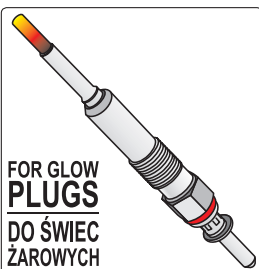

FOR GLOW PLUGS  
 DO ŚWIEC ŻAROWYCH

- GB Torque angle gauge  
D Winkelmesser zum Anziehen von Schrauben  
PL Kałomierz do dokręcania śrub  
RUS Угломер для подвёртывания болтов  
CZ Úhlohměr k utahování šroubů  
H Nyomaték szögmérő  
RO Raportor pt. înşurubat şuruburi  
E Calibrador para apretar tornillos



SLIDING CARD



1/2" 360°  
12.5 mm CrV

|             |  |       |
|-------------|--|-------|
| <b>YATO</b> |  |       |
| YT-0593     |  | 12/48 |

- GB Metal conduit bender  
D Biegevorrichtung für Metallleitungen  
PL Giętarka do przewodów metalowych  
RUS Гибочный станок для проводов из металла
- CZ Ohýbačka kovových trubek  
H Hajlító fémvezetékhez  
RO Maşina de îndoit (curbat) pt. cabluri metalice  
E Dobladora de tubos de metal



125 mm max. ∅ 6 mm L ∅ 25 mm



235 mm max. ∅ 12 mm L ∅ 45 mm

SLIDING CARD



Al

|             |        |       |
|-------------|--------|-------|
| <b>YATO</b> | L (mm) |       |
| YT-0813     | 125    | 24/96 |

|             |        |      |
|-------------|--------|------|
| <b>YATO</b> | L (mm) |      |
| YT-0814     | 235    | 6/48 |

- GB Disc brake pad puller  
D Träge Abziehvorrichtung für die Bremsklötze  
PL Ściągacz bezwładnościowy do klocków hamulcowych  
RUS Инерционный съёмник тормозных колодок
- CZ Pomůcka k vytahování brzdových deštiček  
H Fékbetét kiszedő  
RO Extractor de inerție pt. plăcuțele de frână  
E Desmontador de inercia para las zapatas de freno

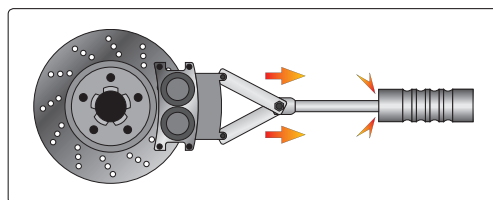

DROP FORGED KUTE

820 g

28~128 mm



COLOR BOX

|             |  |    |
|-------------|--|----|
| <b>YATO</b> |  |    |
| YT-2538     |  | 20 |

- GB Brake retainer spring tool  
D Montagewerkzeug für Bremsfeder  
PL Ściągacz sprężyn szczęk hamulcowych  
RUS Съёмник для тормозных пружин  
CZ Stahovač pružin brzdových čelistí  
H Fékrugó szerelő szerszám  
RO Dispozitiv pt. montaj arc pe sabot  
E Herramienta para resorte retenedor de frenos

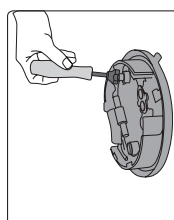

SLIDING CARD



FOR DRUM BRAKES DO HAMULCOW BIEBNOWYCH



|             |  |       |
|-------------|--|-------|
| <b>YATO</b> |  |       |
| YT-0685     |  | 12/96 |

|             |  |       |
|-------------|--|-------|
| <b>YATO</b> |  |       |
| YT-0686     |  | 12/72 |

- GB Brake spring pliers kit  
D Bremsbacken-montage set  
PL Zestaw do montażu szczęk hamulcowych  
RUS Набор инструментов для тормозных пружин  
CZ Sada na montáž brzdových čelistí
- H Fogókészlet fékrugóhoz  
RO Dispozitiv pt. inlocuit garnituri cilindrii receptori  
E Juego para resortes de frenos

3 PCS

FOR DRUM BRAKES DO HAMULCOW BIEBNOWYCH

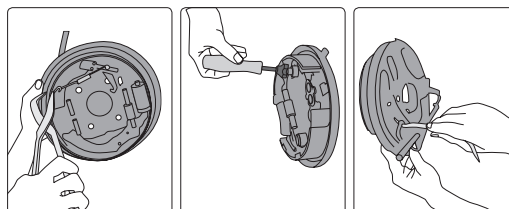

DOUBLE BLISTER



|             |  |      |
|-------------|--|------|
| <b>YATO</b> |  |      |
| YT-0684     |  | 6/24 |

- GB** Professional brake tool set  
**D** Werkzeugsatz zum Wechseln der Bremsbacken  
**PL** Zestaw do wymiany szcęk hamulcowych  
**RUS** Набор для замены тормозных колодок  
**CZ** Sada na výměnu brzdových čelistí  
**H** Fékpofa-cserélő készlet  
**RO** Kit pt. înlocuirea saboților de frână  
**E** Juego para el reemplazo de zapatas de freno



8  
PCS

FOR DRUM  
BRAKES  
DO HAMULCÓW  
BEBNÓWYCH

BMC  
& COLOR  
SLEEVE



**YATO**  
YT-0680 5

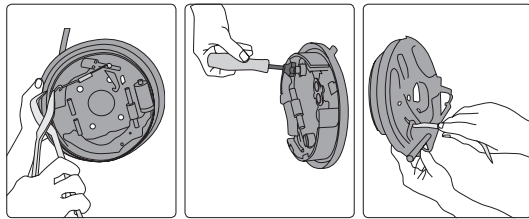

- GB** Speedy brake pad compresses  
**D** Ausdrückvorrichtung für Bremskolben  
**PL** Wyciskacz do tłoczków hamulcowych  
**RUS** Приспособление для выдавливания тормозных поршней  
**CZ** Přípravek k zatlačování brzdových pístů  
**H** Fékdugattyú visszanyomó  
**RO** Presă pt. pistoane de frână  
**E** Expulsor para pistones de frenos



15-90  
mm

COLOR  
BOX



**YATO**  
YT-0604 16

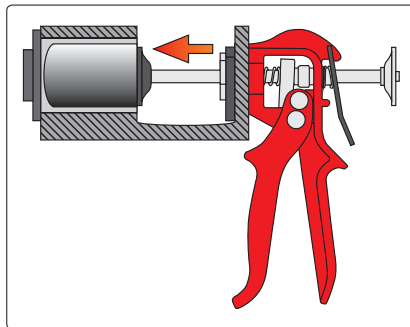

- GB** Disc brake spreader  
**D** Scheibenbremsen Abscheider  
**PL** Separator do hamulców tarczowych  
**RUS** Распорка тормозных дисков  
**CZ** Přípravek na montáž brzdových prasátek  
**H** Fékmunkahenger visszanyomó  
**RO** Separator disc abreiaj  
**E** Separador de frenos de discos

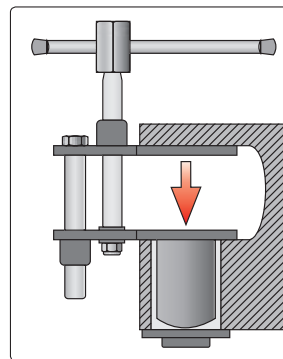

0-65  
mm 1/2" (12.5 mm)  
21 mm

COLOR BOX



**YATO**  
YT-0610 12/24

- GB** Disc brake piston tool  
**D** Bremskolbenrücksteller universal  
**PL** Uniwersalny klucz do wkręcania zacisków hamulcowych  
**RUS** Ключ для тормозного поршня  
**CZ** Univerzální klíč k montáži brzdových třmenů  
**H** Féknyereg összenyomó  
**RO** Dispozitiv pt. impins etrier  
**E** Llave para comprimir pistones del freno de disco



3/8" 10 mm CrV

SLIDING  
CARD



**YATO**  
YT-0683 12/96

for / dla: GM, FORD, Chrysler, VW, Fiat

- GB Disc brake pad & caliper service tool kit  
D Werkzeugsatz von manuellen Separatoren für die Bremmsklemmen  
PL Zestaw ręcznych separatorów do zacisków hamulcowych  
RUS Набор ручных сепараторов для тормозных зажимов  
CZ Ruční sada na montáž kotoučových brzd  
H Fékmunkahenger prés készlet  
RO Set de separatoare manuale pt. etrier frâna  
E Juego de separadores manuales para abrazaderas de freno

11  
PCS

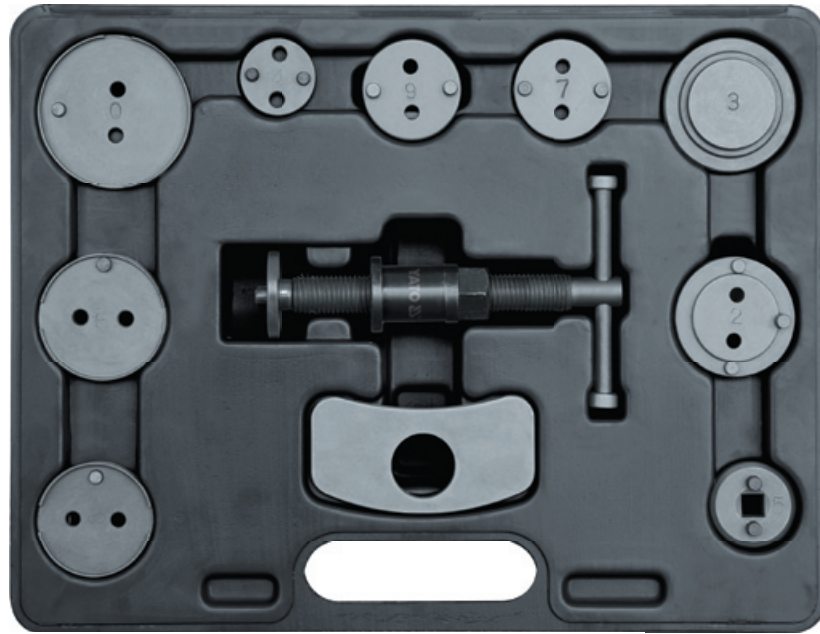

BMC  
& COLOR  
SLEEVE

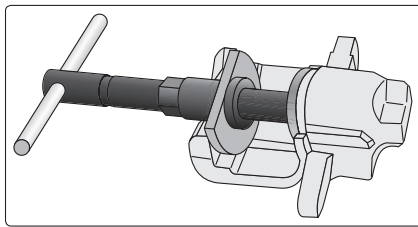

| YATO    | No.            | zacisk przedni (F)  | zacisk tylny (R)                                   |   |
|---------|----------------|---|--|---|
| YT-0681 | 1-1            | sitownik  |  | 5 |
|         | 1              | plytka oporowa  |  |   |
|         | 5              | adapter z gniazdem  |  |   |
|         | 2              | Citroen: XM, Xantia   |  |   |
|         | 3              | Alfa Romeo, Audi, Austin, BMW, Honda, Jaguar, MB, Mitsubishi, Nissan, Rover, Toyota, VW |  |   |
|         | 4              |   | Ford, Mazda, Subaru, Alfa Romeo, Saab              |   |
|         | 6              |   | Nissan   |   |
|         | 7              |   | Audi, Ford, Honda, Nissan, Rover, Saab, Subaru, VW |   |
|         | 8              | General Motors  |  |   |
| 9       | General Motors |   |  |   |

- GB Disc brake pad & caliper service tool kit  
D Werkzeugsatz von manuellen Separatoren für die Bremmsklemmen  
PL Zestaw ręcznych separatorów do zacisków hamulcowych  
RUS Набор ручных сепараторов для тормозных зажимов  
CZ Ruční sada na montáž kotoučových brzd  
H Fékmunkahenger prés készlet  
RO Set de separatoare manuale pt. etrier frâna  
E Juego de separadores manuales para abrazaderas de freno

12  
PCS

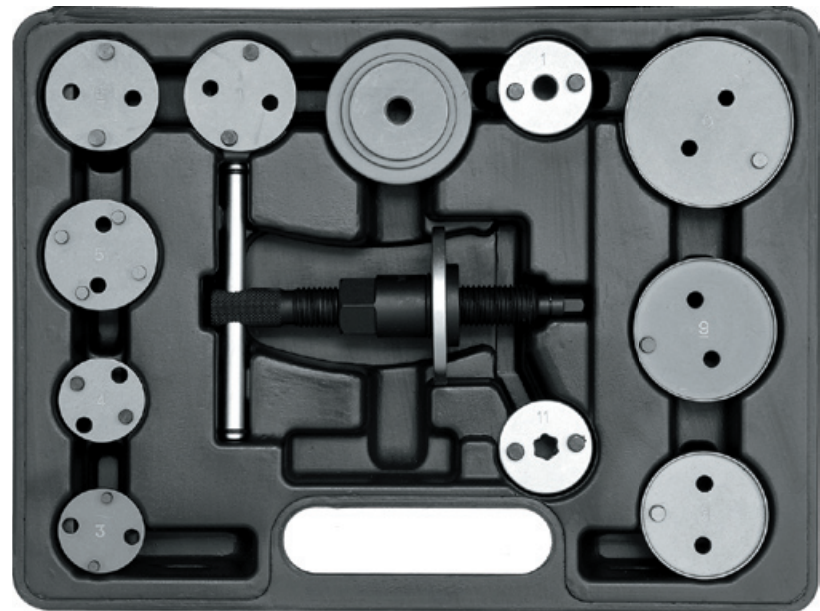

BMC  
& COLOR  
SLEEVE

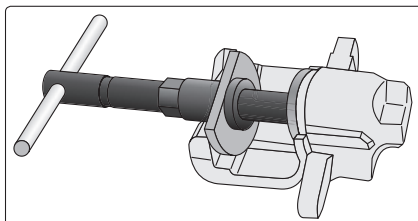

| YATO    | No. | zacisk przedni (F)   | zacisk tylny (R)   |    |
|---------|-----|--|--|----|
| YT-0611 | 0   | General Motors - zaciski 2 1/2" (63.5 mm)  |  | 10 |
|         | 1   | Adapter do przedniego zacisku  |  |    |
|         | 2   | Citroen XM, Xantia (F/R)   |  |    |
|         | 3   |  | Opel (R)   |    |
|         | 4   |  | Ford (R), Mazda (R), Saab (R), Alfa Romeo 164 2.0 (R), Honda (R), General Motors (R) |    |
|         | 5   | Nissan Maxima  |  |    |
|         | 6   |  | Nissan Primera, VW Golf IV   |    |
|         | 7   | Audi (F), Rover, Subaru (F), Ford (F), Nissan (F), Peugeot (F), Toyota (F), VW (F) |  |    |
|         | 8   | General Motors - zaciski 1 7/8" (47.6 mm)  |  |    |
|         | 9   | General Motors - zaciski 2 1/8" (54.0 mm)  |  |    |
|         | 11  |  | Adapter do tylnego zacisku   |    |

16

- GB Disc brake pad & caliper service tool kit
- D Werkzeugsatz von manuellen Separatoren für die Bremssklemmen
- PL Zestaw ręcznych separatorów do zacisków hamulcowych
- RUS Набор ручных сепараторов для тормозных зажимов
- CZ Ruční sada na montáž kotoučových brzd
- H Fékmunkahenger prés készlet
- RO Set de separatoare manuale pt. etrier frâna
- E Juego de separadores manuales para abrazaderas de freno

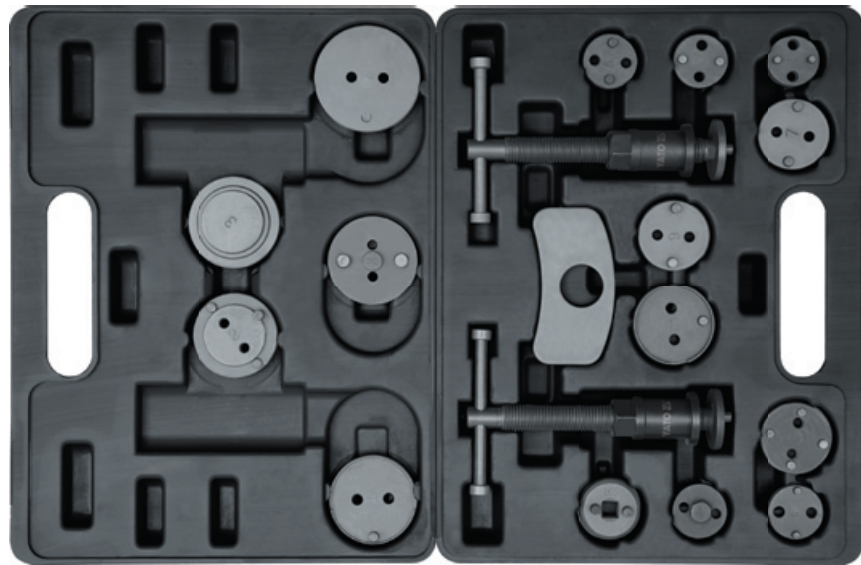
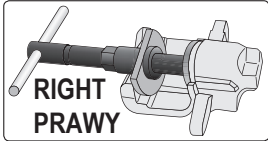
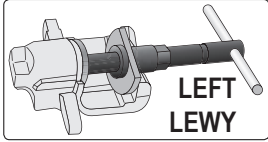

**18  
PCS**

BMC  
& COLOR  
SLEEVE



| YATO    | No.               | zacisk tylny (R)                   | zacisk tylny (R)   |
|---------|-------------------|------------------------------------|--|
| YT-0682 | 1-1               | silowniki z lewym i prawym gwintem |  |
|         | 1                 | płytki oporowa                     |  |
|         | 5                 | 3/8" (10.0 mm)                     | adapter z gniazdem   |
|         | 0                 | 2 1/2" (63.5 mm)                   | General Motors   |
|         | 2                 | 2 1/64" (51.0 mm)                  | Citroen XM, Xantia   |
|         | 3                 | 2 5/32" (55.0 mm)                  | Audi, Alfa Romeo, Fiat, Ford Fiesta, Honda, Jaguar, BMW, Mercedes, Mitsubishi Colt, Nissan, Rover, Austin, Toyota Camry, Volvo, VW: Passat, Golf GTI |
|         | 4                 | 1 1/4" (32.0 mm)                   | Jaguar   |
|         | 6                 | 1 21/32" (42.0 mm)                 | Ford, Mazda, Saab, Alfa Romeo 164, Honda, General Motors   |
|         | 7                 | 1 21/32" (42.0 mm)                 | Nissan Primera, VW Golf IV   |
|         | 8                 | 1 7/8" (48.0 mm)                   | Audi, Rover, Subaru, Ford, Nissan, Peugeot, Toyota, VW   |
|         | 9                 | 2 1/8" (54.0 mm)                   | General Motors, Cadillac   |
|         | E                 | 1 21/32" (42.0 mm)                 | Nissan Maxima  |
|         | G                 | 1 1/4" (32.0 mm)                   | Opel   |
|         | K                 | 2 1/8" (54.0 mm)                   | Citroen  |
|         | M                 | 1 1/4" (32.0 mm)                   | Ford   |
|         | N                 | 1 1/4" (32.0 mm)                   | Saab, Honda  |
| Z       | 1 3/16" (30.0 mm) | Renault                            |  |

- GB Disk brake pad and caliper
- D Pneumatischer Werkzeugsatz für Bremssattelsysteme
- PL Pneumatyczny zestaw do zacisków hamulcowych
- RUS Пневматический набор к тормозным зажимам
- CZ Pneumatická souprava k montáži kotoučových brzd
- H Pneumatikus készlet fék-munkahengerekhez
- RO Ansamblu pneumatic pt. cilindre de frana
- E Juego de herramientas neumaticas para apretadores de frenos

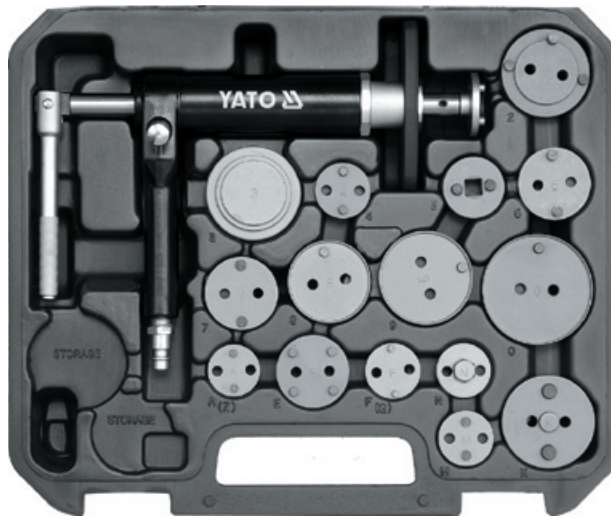
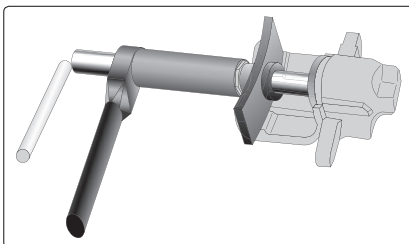

**16  
PCS**

**0.75  
MPa**

**1/4"  
6.3mm**

BMC  
& COLOR  
SLEEVE



| YATO    | No. | zacisk przedni (F)   | zacisk tylny (R)   |
|---------|-----|--|--|
| YT-0671 | 0   | General Motors - zaciski 2 1/2" (F) (63.5 mm)  |  |
|         | 2   |  | Citroen XM, Xantia (F/R)   |
|         | 3   | Audi (F), Alfa Romeo (F), Fiat (F), Ford Fiesta (F), Isuzu (F), Honda Concerto (F), Jaguar (F/R), BMW (F), Mercedes-Benz (F), Mitsubishi Colt (F), Nissan: Almera, Stanza, Sunny (F), Rover (F), Toyota Camry (F), Volvo (F), VW (F) |  |
|         | 4   |  | Ford (R), Mazda (R), Saab (R), Alfa Romeo 164 2.0 (R), Honda (R), General Motors (R) |
|         | 5   |  | Adapter z gniazdem 3/8"  |
|         | 6   |  | Nissan Primera (R), VW Golf IV (R)   |
|         | 7   |  | Audi (R), Rover, Subaru (R), Ford (R), Nissan (R), Peugeot (R), Toyota (R), VW (R)   |
|         | 8   | General Motors - zaciski 1 7/8" (47.6 mm)  |  |
|         | 9   | General Motors - zaciski 2 1/8" (54.0 mm)  |  |
|         | A   |  | Renault (R)  |
|         | E   |  | Nissan Maxima (F/R)  |
|         | F   |  | Opel (R)   |
|         | K   |  | Citroen (R)  |
|         | M   |  | Ford (R), Cooper (R)   |
| N       |     | Saab, Honda (F/R)  |  |



- GB Coil spring clamp  
D Federspanner  
PL Ściągacz do sprężyn  
RUS Съёмник пружин  
CZ Stahovák pružin tlumičůu automobilůu

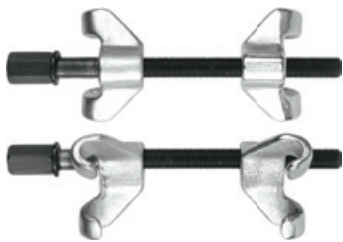

**2**  
PCS  
1/2" (12.5 mm)  
21 mm

COLOR BOX

| YATO    | Ø (mm) | L (mm) |      |
|---------|--------|--------|------|
| YT-0605 | 90     | 200    | 5/10 |

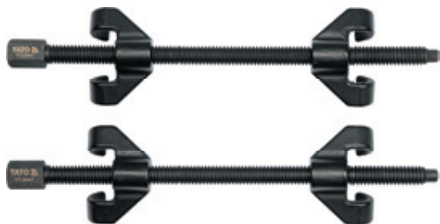

CrV

| YATO    | Ø (mm) | L (mm) |   |
|---------|--------|--------|---|
| YT-2544 | 82     | 370    | 8 |

COLD FORGED  
KUTE  
NA ZIMNO

| YATO    | Ø (mm) | L (mm) |   |
|---------|--------|--------|---|
| YT-2546 | 82     | 280    | 8 |
| YT-2547 | 82     | 355    | 8 |

- GB Macpherson spring dumper extractor  
D Abziehvorrichtung für Federn von MacPherson  
PL Ściągacz do sprężyn MacPhersona  
RUS Съёмник пружин подвески Макферсона  
CZ Stahovák pružin McPherson  
H MacPerson rugó összehúzó  
RO Extractor de arcuři MacPherson  
E Desmontador para los resortes de MacPherson

CrMo  
SCM-415

**3**  
POINTS  
OF FIXING  
PUNKTY  
MOCOWANIA

max.  
2900kg



WHITE  
CARTON BOX  
& COLOR  
LABEL



| YATO    |  |   |
|---------|--|---|
| YT-2535 |  | 2 |

- GB Vice for shock absorber  
D Halterung, Schraubstock für die Säule von MacPherson  
PL Uchwyt, imadło do kolumny MacPhersona  
RUS Тиски к подвеске Макферсона  
CZ Uprínací přípravek, svěrák na nápravu McPherson  
H Fogantyú, satu MacPerson oszlophoz  
RO Măner, menghină pt. coloana MacPherson  
E Mandril, tomo para la columna de MacPherson

35-70  
mm

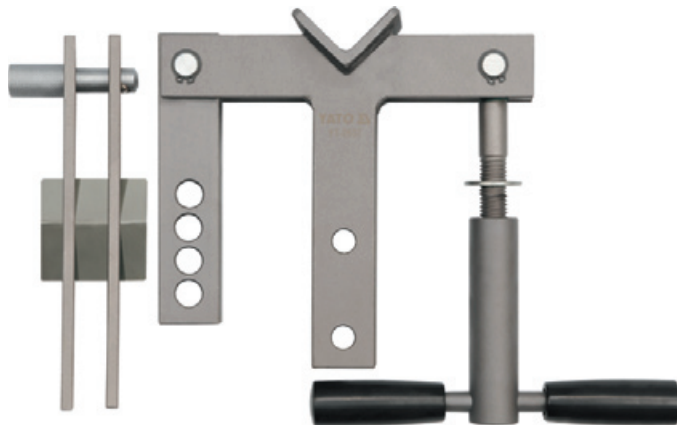

WHITE CARTON BOX  
& COLOR LABEL



| YATO    |  |   |
|---------|--|---|
| YT-2537 |  | 5 |

- GB Interchangeable fork spring compressor and removal tool  
D Abziehvorrichtung für MacPherson-Federn mit austauschbaren Halterungen  
PL Ściągacz do sprężyn MacPhersona z wymiennymi uchwytami  
RUS Стяжка для снятия пружин Макферсона со сменными полукольцами  
CZ Stahovák pružin McPherson s vyměnitelnými čelistmi  
H MacPerson rugó összehúzó cserélhető pófákkal  
RO Ancoră suspensie MacPherson cu măneri interschimbabile  
E Extractor de resortes MacPherson con mangos intercambiables

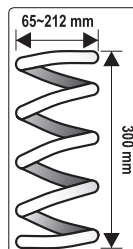

**7**  
PCS

65-125  
mm

88-160  
mm

max.  
1500kg

126-212  
mm

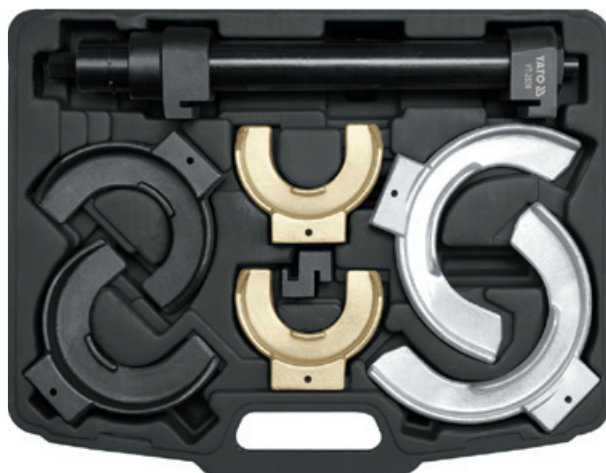

BMC  
& COLOR  
SLEEVE



| YATO    |  |   |
|---------|--|---|
| YT-2536 |  | 1 |

GB Drive nut set  
 D Stoszdämpfer Nutmutter Einsätze  
 PL Zestaw nasadek do amortyzatorów  
 RUS Набор головок для амортизаторов  
 CZ Sada hlavic na uložení tlumiče  
 H Lengéscsillapítókiészítő szet  
 RO Set prezoane  
 E Juego de boquillas de amortiguadores

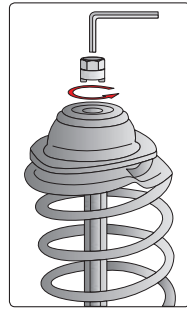

5  
PCS

SLIDING CARD

- No. 1 10.5 mm VW Golf rear
- No. 2 12.5 mm VW Golf front
- No. 3 14.5 mm VW Polo, Golf, Passat, Audi 80
- No. 4 14.5 mm Austin Maestro
- No. 5 14.0 mm Mercedes Benz C-Class (W203)

| YATO    | size / rozmiar (mm)          |       |
|---------|------------------------------|-------|
| YT-0621 | 10.5; 12.5; 14.5; 14.5; 14.0 | 12/48 |

GB Turnbuckle for shock absorber's top lid  
 D Schlüsselsatz zum Befestigen der Stoßdämpfer  
 PL Zestaw kluczy do mocowania amortyzatorów  
 RUS Набор ключей для крепления амортизаторов

CZ Sada klíčů k montáži tlumičů  
 H Kulcskészlet lengéscsillapítók rögzítéséhez  
 RO Set chei pt. fixare amortizoare  
 E Juego de llaves para la instalación de amortiguadores

39  
PCS

CrMo  
SCM-415

CrV  
6140

CrV  
50BV30

STEEL  
8660

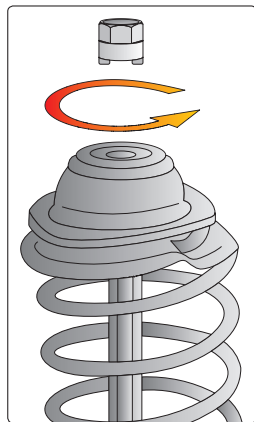

BMC  
& COLOR  
SLEEVE



| YATO        | size / rozmiar (mm)        | type of car / model samochodu  | size / rozmiar (mm) | type of car / model samochodu |   |
|-------------|----------------------------|--|---------------------|-------------------------------|---|
| CrMo SCM415 | 10.5 x 3.5                 | VW Golf Rear Axle  | CrV 6140            | D5                            | Nissan  |
|             | 12.5 x 3.5                 | VW Golf Front Axle   |                     | D10                           | Nissan, Ford  |
|             | 14.5 x 5                   | VW Polo, Golf, Passat, Audi 80   |                     | 8                             | Mercedes-Benz   |
|             | 14.5 x 3                   | Austin Maestro   |                     | 9                             | Opel/Vauxhall, Chrysler   |
|             | 14 x 2.5                   | Mercedenz Benz W203 (C-class), W209 (CLK)                                |                     | 10                            | Chrysler, Ford  |
|             | 14                         | Honda, Nissan  |                     | 11                            | Japanese Cars   |
|             | 16                         | VW, Audi, Seat, Fiat   |                     | 5                             | Honda   |
|             | 17                         | Ford, VW, Audi, Seat, Fiat   |                     | 6                             | Seat, Fiat, Citroen, Peugeot, Ford, Opel, Renault, Japanese Cars, BMW |
|             | 18                         | Ford, VW, Audi, Seat, Rover, Fiat, Opel, Peugeot, Renault, Japanese Cars |                     | 7                             | VW, Audi, Seat, Fiat, Citroen, Peugeot, Mercedes-Benz (W203), Renault |
|             | 19                         | VW, Audi, Seat, Citroen, Fiat, Opel, Peugeot, Toyota                     |                     | 8                             | Mercedes-Benz   |
|             | 21                         | Mercedenz-Benz W203, Chrysler, VW, Audi, Ford, Japanese Cars             |                     | 3                             | Mercedes-Benz, Opel, Renault  |
|             | 22                         | VW, Audi, Seat, Citroen, Fiat, Opel, Peugeot, Renault, BMW               |                     | 3.5                           | Chrysler, Ford, Citroen, Peugeot                                      |
| 24          | Volvo                      | 4  | Citroen, Peugeot    |                               |   |
| 27          | VW, Audi, Citroen, Peugeot | M12  | Opel/Vauxhall       |                               |   |
| 4           | Nissan                     | T50  | Nissan, Ford        |                               |   |
| 5.2         | VW, Audi, Nissan           | T60  | Ford                |                               |   |
| 6           | VW, Audi, Renault          |  |                     |                               |   |
| 6.3         | Nissan                     |  |                     |                               |   |
| 7           | VW, Audi, Seat, Fiat       |  |                     |                               |   |
| 8           | Seat, Fiat                 |  |                     |                               |   |
| 9           | Japanese Cars              |  |                     |                               |   |
| 10          | Seat, Fiat, Volvo          |  |                     |                               |   |
| 12          | Seat, Fiat                 |  |                     |                               |   |

GB Tire valve stem inserter  
 D Abziehvorrichtung für die Gummiventile  
 PL Przeciągacz do zaworków gumowych  
 RUS Протяжка к резиновым клапанам

CZ Páka k provlékání bezdušových ventilků  
 H Gumiszelep-metsző  
 RO Broșă pt. supapele cauciucate  
 E Brocha de tracció para las válvulas de goma

290  
mm

RUBBER  
VALVES  
ZAWORKY  
GUMOWE



SLIDING CARD

| YATO    | L (mm) |       |
|---------|--------|-------|
| YT-0619 | 290    | 12/72 |

GB Wheel balance pliers  
D Auswuchtgewicht-Zange  
PL Szczyrce do wyważania kół  
RUS Клеști для балансировки колес  
CZ Kleště pro vyvažování kol  
H Centírsúly szerelő szerszám  
RO Cleste pt. cauciuc  
E Tenazas de equilibrar ruedas

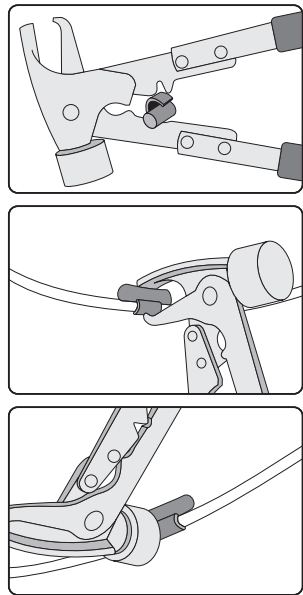

**YATO**  
YT-0643 12/48

GB Wheel balance pliers with cover  
D Auswuchtgewicht-Zange mit Schutzkappe  
PL Szczyrce do wyważania kół z osłoną  
RUS Клеști с защитой для балансировки колес  
CZ Kleště pro vyvažování kol s ochranou  
H Centírsúly szerelő szerszám védőkupakkal  
RO Cleste pt. cauciuc cu protectie  
E Tenazas de equilibrar ruedas, con protector



PROTECTION  
HEAD  
OSŁONA

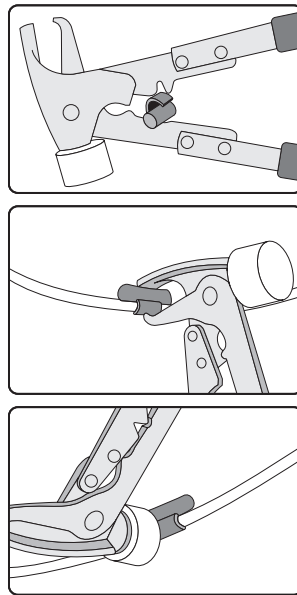

**YATO**  
YT-0644 6/48

GB Deep thin wall impact sockets  
D Schon-Kraftschraubereinsatz für Alufelgen  
PL Zestaw nasadek udarowych do felg aluminiowych  
RUS Набор головок для алюминиевых дисков  
CZ Sada nástrčných klíčů na alu ráčky  
H Hosszított dugókulcs készlet, könnyűfém felnikhez  
RO Diblu de impact cu mufare in interior  
E Juego de boquillas de percusión para llantas de aluminio

- for service station and tire workshops
- for maximum impact loads
- drive locks
- ultra thin walls and nylon cover for working with alu rims
- anodised colour finish for fast identification of size

- dla serwisów i warsztatów oponiarskich
- do największych obciążeń udarowych i tętniących
- zamki blokujące
- ultra cienkie ścianki i nylonowe pokrycie do pracy z felgami aluminiowymi
- anodowane kolorowe wykończenie dla szybkiej identyfikacji rozmiaru



1/2" 3 PCS AS-DRIVE  
12.5 mm CrMo SCM-440 17 19 21 mm  
26 29 31 mm



BMC & COLOR BOX

**YATO**  
YT-1056 1/2" (12.7 mm) 12/24

GB Rubber valve core torque tool  
D Drehmomentwerkzeug für gummi Dichtende Reifventileinsätze  
PL Klucz dynamometryczny do zaworków gumowych  
RUS Ключ динамометрический для резиновых клапанов  
CZ Klíč momentový k montáži gumových ventilů  
H Szeleptűkiszereelő kulcs gumitömítésű szelephez  
RO Surubelnita din plastic pt. supapa  
E Llave dinamométrica de válvulas de goma



0.25 Nm  
RUBBER VALVES ZAWORY GUMOWE

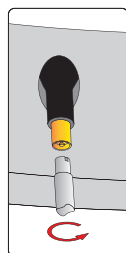

**YATO**  
YT-0795 50/200

GB Metal valve core torque tool  
D Drehmomentwerkzeug für metallisch Dichtende Reifventileinsätze  
PL Klucz dynamometryczny do zaworków metalowych  
RUS Ключ динамометрический для металлических клапанов  
CZ Klíč momentový k montáži kovových ventilů  
H Szeleptűkiszereelő kulcs fémtömítésű szelephez  
RO Surubelnita metalica pt. supapa  
E Llave dinamométrica de válvulas de metal



0.45 Nm  
METAL VALVES ZAWORY METALOWE

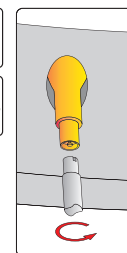

**YATO**  
YT-0796 50/200

- GB Cross rim wrench  
 D Kreuzschlüssel  
 PL Krzyżakowy klucz do kół  
 RUS Ключ-крест балонный  
 CZ Klíč na kola křížový  
 H Kereszt kerékkulcs  
 RO Cheie în cruce pt. roți  
 E Llave cruz para ruedas



CrV



PLASTIC HANGER

| YATO    | size / rozmiar                |    |
|---------|-------------------------------|----|
| YT-0800 | 17 x 19 x 21 x 22 mm          | 10 |
| YT-0801 | 17 x 19 x 21 x 1/2" (12.7 mm) | 10 |
| YT-0802 | 24 x 27 x 32 x 3/4" (19.0 mm) | 3  |

- GB T-type sleeved ratchet wrench  
 D Radmutter Schlüssel für Autos  
 PL Klucz do kół samochodowych

- RUS Ключ к автомобильным колесам  
 CZ Klíč na kola automobilů  
 H Kerékkulcs

- RO Cheie pt. roți de automobile  
 E Llave para las ruedas de automóviles

1/2" 4 PCS  
 12.5 mm 44T  
 AS-DRIVE CrV 50BV30



PLASTIC HANGER

| YATO    |                                   |      |
|---------|-----------------------------------|------|
| YT-0803 | 1/2" (12.7 mm): 17, 19, 21, 23 mm | 5/10 |

- GB Wrecking bar  
 D Reifenmontierhebel  
 PL Łyżka do opon

- RUS Прибор для шиномонтажа  
 CZ Montážní páka na pneumatiky  
 H Gumiabroncs kar

- RO Levier pt. roti  
 E Desmontable para las llantas

300 mm 400 mm 500 mm 600 mm CrV



| YATO    | size / rozmiar (mm) |      |
|---------|---------------------|------|
| YT-0807 | 300                 | 20   |
| YT-0808 | 400                 | 20   |
| YT-0809 | 500                 | 5/20 |
| YT-0810 | 600                 | 5/20 |

- GB Tire level  
 D Reifenmontierhebel  
 PL Łyżka do opon

- RUS Прибор для шиномонтажа  
 CZ Montážní páka na pneumatiky  
 H Gumiabroncs kar

- RO Levier pt. roti  
 E Desmontable para las llantas

SLIDING CARD

380 mm CrMo



| YATO    | size / rozmiar (mm) |       |
|---------|---------------------|-------|
| YT-0811 | 380                 | 10/50 |

- GB Extra long flexi shaft ratchet  
 D Ratsche auf biegsamer Welle  
 PL Elastyczny walek z grzechotką  
 RUS Вороток к головке с трещоткой  
 CZ Ráčna s flexibilní rukojetí

- H Racsnis szár flexibilis hajtással  
 RO Prelungitor flexibil pt. bormasina cu clichet  
 E Árbol flexible con carraca

HALF DOUBLE BLISTER

3/8" 400 mm 31 Nm  
 10 mm 1/4" (6.3 mm) 41T



| YATO    |  |       |
|---------|--|-------|
| YT-0726 |  | 10/40 |

- GB Right angled drive, flexi shaft  
 D Bithalter auf biegsamer Welle  
 PL Elastyczny walek z uchwytem do bitów

- RUS Вороток для бит (под отвертку)  
 CZ Ráčna na bity s flexibilní rukojetí  
 H Bittartó flexibilis hajtással

- RO Prelungitor flexibil pt. bormasina  
 E Árbol flexible con mandril portapuntas

HALF DOUBLE BLISTER

400 mm 31 Nm  
 1/4" (6.3 mm) MAGNETIC BIT 1/4" (6.3 mm)



| YATO    |  |       |
|---------|--|-------|
| YT-0727 |  | 10/40 |

GB Rectangular telescopic inspection mirror  
D Teleskop Inspektionsspiegel  
PL Lusterko inspekcyjne  
RUS Зеркало инспекционное телескопическое  
CZ Zrcátko kontrolní teleskopické  
H Vizsgáló tükör, teleszkópos nyéllel

RO Oglinda telescopică pt. inspectie  
E Espejo rectangular telescópico de inspección

50x90 mm

TELESCOPIC HANDLE  
285x770 mm



**YATO**  
YT-0660 12/144

GB LED lighted telescopic inspection mirror  
D Prüfspiegel mit Beleuchtung  
PL Lusterko inspekcyjne z lampką  
RUS Зеркало досмотровое с подсветкой  
CZ Inspekční zrcadélko s lampou  
H Vizsgáló tükör, lámpával

RO Oglindă pt. inspectie cu lampă  
E Espejo de control con lámpara



265 - 920 mm; ∅54 mm  
TELESCOPIC HANDLE  
TELESKOPOWY UCHWYT



**YATO**  
YT-0663 10/100

GB Industrial videoscope  
D Industrielles Videoskop  
PL Wideoskop przemysłowy  
RUS Промышленный видеоскоп  
CZ Průmyslový videoskop  
H Ipari videoszókp  
RO Videoscop industrial  
E Videoscopio industrial



LCD COLOR SCREEN



KOLOROWY EKRAN LCD

BMC & COLOR SLEEVE



**YATO** LCD TFT  
YT-7291 2.4" (61 mm) 4  
YT-7290 3.5" (89 mm) 4

GB Industrial videoscope RUS Промышленный H Ipari videoszókp  
 D Industrielles Videoskop видеоскоп RO Videoscop industrial  
 PL Wideooskop przemysłowy CZ Průmyslový videoskop E Videoscopio industrial

BMC & COLOR SLEEVE

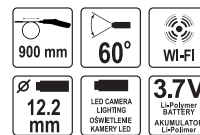

|             |              |   |
|-------------|--------------|---|
| <b>YATO</b> | LCD TFT      |   |
| YT-7292     | 3.5" (89 mm) | 4 |



|             |              |   |
|-------------|--------------|---|
| <b>YATO</b> | LCD TFT      |   |
| YT-7293     | 3.5" (89 mm) | 4 |



|             |  |   |
|-------------|--|---|
| <b>YATO</b> |  |   |
| YT-7294     |  | 4 |

GB Camera with cable for / dla: YT-7290, YT-7291, YT-7292, YT-7293, YT-7294

D Kamera mit der Leitung  
 PL Kamera z przewodem  
 RUS Камера с проводом  
 CZ Kamera s kabelem  
 H Kamera a vezetékkel  
 RO Cameră de cablul  
 E Càmara con el cable

COLOR BOX



LED



9.0 mm 1 m



5.5 mm 1 m

|             |  |    |
|-------------|--|----|
| <b>YATO</b> |  |    |
| YT-7295     |  | 10 |

|             |  |    |
|-------------|--|----|
| <b>YATO</b> |  |    |
| YT-7296     |  | 10 |



12.2 mm 1 m



12.2 mm 2 m

|             |  |    |
|-------------|--|----|
| <b>YATO</b> |  |    |
| YT-7297     |  | 10 |

|             |  |    |
|-------------|--|----|
| <b>YATO</b> |  |    |
| YT-7298     |  | 10 |

GB Telescopic magnetic pick up tool  
D Teleskop magnet Heber  
PL Chwytnak teleskopowy z magnesem

RUS Захват магнитный телескопический  
CZ Patka teleskopická magnetická  
H Felszedő mágnes, teleszkópos nyéllel

RO Telescop magnetic  
E Herramienta levantadora magnética, telescopica



|             |        |
|-------------|--------|
| <b>YATO</b> |        |
| YT-0661     | 12/144 |

GB Telescopic magnetic pick up tool  
D Teleskop magnet Heber  
PL Chwytnak teleskopowy z magnesem  
RUS Захват магнитный телескопический  
CZ Patka teleskopická magnetická  
H Felszedő mágnes, teleszkópos nyéllel  
RO Telescop magnetic  
E Herramienta levantadora magnética, telescopica



|             |        |      |
|-------------|--------|------|
| <b>YATO</b> | L (mm) |      |
| YT-0860     | 59-99  | 6/24 |

GB Magnetic sweeper  
D Magnetkehrer  
PL Magnetyczna listwa zbierająca  
RUS Магнитный сборник металлических предметов  
CZ Magnetická metla  
H Mágneses gyűjtőléc  
RO Colector magnetic  
E Recogedor magnético



|             |        |      |
|-------------|--------|------|
| <b>YATO</b> | L (mm) |      |
| YT-0861     | 59-99  | 6/12 |

GB Telescopic pick up and mirror set  
D Inspektionssatz: Spiegel + Greifer  
PL Zestaw inspekcyjny: lusterko + chwytnak  
RUS Проверочный набор - держатель и зеркальце  
CZ Inspekční souprava: zrcadlo + držák  
H Teleszkópos ellenőrző készlet: tükör + felvevő  
RO Garnitură de control: oglindă + benă  
E Juego de inspección: espejo + cuchara de mordazas

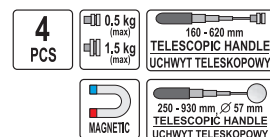

|             |       |
|-------------|-------|
| <b>YATO</b> |       |
| YT-0662     | 10/40 |

GB Magnetic bowl  
D Magnetschale  
PL Miska magnetyczna

RUS Магнитный поднос  
CZ Miska magnetická  
H Mágneses tálca

RO Tava magnetica  
E Bandeja de accesorios magnética



|             |       |  |
|-------------|-------|--|
| <b>YATO</b> |       |  |
| YT-0830     | 12/48 |  |

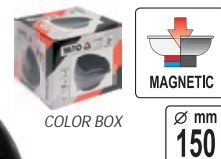

|             |    |  |
|-------------|----|--|
| <b>YATO</b> |    |  |
| YT-08305    | 20 |  |

GB Magnetic parts tray  
D Magnetschale  
PL Miska magnetyczna  
RUS Магнитный поднос  
CZ Miska magnetická  
H Mágneses tálca  
RO Tava magnetica  
E Bandeja de accesorios magnética



|             |      |
|-------------|------|
| <b>YATO</b> |      |
| YT-0831     | 6/12 |

GB Magnetic tool holder  
D Magnet Werkzeughalter  
PL Listwa magnetyczna  
RUS Магнитная рейка

CZ Magnetický držák nářadí  
H Mágneses tartó

E Bandeja de accesorios magnética

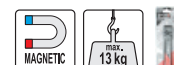

SLIDING CARD

|             |      |
|-------------|------|
| <b>YATO</b> |      |
| YT-0835     | 4/16 |

GB Tweezer CZ Pinzeta  
 D Pinzette H Csipesz  
 PL Pęseta RO Pensetă  
 RUS Пинцет E Pinzas

SLIDING  
CARD



302  
STAINLESS  
STEEL  
SIŁY  
NIEKORZYWNIA

ANTI  
MAGNETIC  
ANTYMAG-  
NETYCZNA

ANTIACID  
KWASO-  
ODPORNA



140  
mm

HRC  
30

| YATO    | L (mm) |        |
|---------|--------|--------|
| YT-6903 | 140    | 20/480 |



115  
mm

HRC  
30

| YATO    | L (mm) |        |
|---------|--------|--------|
| YT-6907 | 115    | 20/480 |



180  
mm

HRC  
30

| YATO    | L (mm) |        |
|---------|--------|--------|
| YT-6909 | 180    | 20/480 |



170  
mm

HRC  
30

| YATO    | L (mm) |        |
|---------|--------|--------|
| YT-6910 | 170    | 20/480 |



130  
mm

HRC  
40

\* - product not for european market  
 \* - produkt nieprzeznaczony na rynek europejski

| YATO     | L (mm) |        |
|----------|--------|--------|
| YT-6912* | 130    | 20/480 |



130  
mm

HRC  
40

| YATO    | L (mm) |        |
|---------|--------|--------|
| YT-6913 | 130    | 20/480 |



140  
mm

HRC  
40

| YATO    | L (mm) |        |
|---------|--------|--------|
| YT-6916 | 140    | 20/480 |



115  
mm

HRC  
40

| YATO    | L (mm) |        |
|---------|--------|--------|
| YT-6917 | 115    | 20/480 |



145  
mm

HRC  
40

SELF  
CLAMPING  
SAMOZA-  
CIŚKOWA

| YATO    | L (mm) |        |
|---------|--------|--------|
| YT-6918 | 145    | 20/480 |



140  
mm

HRC  
40

SELF  
CLAMPING  
SAMOZA-  
CIŚKOWA

| YATO    | L (mm) |        |
|---------|--------|--------|
| YT-6920 | 140    | 20/480 |



GB Workshop creeper  
D Werkstatt-Liege  
PL Leżanka warsztatowa  
RUS Лежак ремонтный  
CZ Lehátko  
H Fekpad gurulos  
RO Targa  
E Camilla de taller



100 cm



WHITE BOX & COLOR LABEL



**YATO**

YT-0880



1

GB Rechargeable work lamp  
D Led Werkstattlampe  
PL Diodowa lampa bezprzewodowa  
RUS Светодиодная беспроводная лампа  
CZ Montážní lampa diodová bezpřívodová  
H Ledlámpa  
RO Lampa cu led fara cablu  
E Lámpara inalámbrica de diodos

230V~50Hz  
BATTERY CHARGER  
LADOWARKA

30 LED

4.8V  
3300mAh  
NiMH

8-10 h

BATTERY CHARGER  
LADOWARKA

SHOCK PROOF  
ODPORNA NA WSTRZASY

OIL PROOF  
ODPORNA NA OLEJ

WATER PROOF  
ODPORNA NA WODĘ



DOUBLE BLISTER



**YATO**

YT-0850



3/6

GB Rechargeable work lamp  
D Led Werkstattlampe  
PL Diodowa lampa bezprzewodowa  
RUS Светодиодная беспроводная лампа  
CZ Montážní lampa diodová bezpřívodová  
H Ledlámpa  
RO Lampa cu led fara cablu  
E Lámpara inalámbrica de diodos

21+5 LED

3 POSITION  
POZYCJE

3.6V  
1800mAh  
NiMH

230V~50Hz  
BATTERY CHARGER  
LADOWARKA

21 LED  
4-5h

5 LED  
10h

WATER PROOF  
ODPORNA NA WODĘ

OVERLOAD PROTECTION  
ZABEZPECZENIE PRZEŁADOWANIA

SHOCK PROOF  
ODPORNA NA WSTRZASY

OIL PROOF  
ODPORNA NA OLEJ

SHORTAGE PROTECTION  
ZABEZPECZENIE PRZECIWOBRZĄDZENIE



MAGNETIC

COLOR BOX



**YATO**

YT-0851



20

GB Rechargeable work lamp  
D Led Werkstattlampe  
PL Diodowa lampa warsztatowa  
RUS Светодиодная беспроводная лампа  
CZ Montážní lampa diodová bezpřívodová  
H Ledlámpa  
RO Lampa cu led fara cablu  
E Lámpara inalámbrica de diodos

27 LED

13000 MCD

3.6V  
1200mAh  
NiMH

230V~50Hz  
BATTERY CHARGER  
LADOWARKA

4 h

CHARGING TIME  
CZAS ŁADOWANIA  
4 h

WATER PROOF  
ODPORNA NA WODĘ

MAGNETIC



DOUBLE BLISTER



**YATO**

YT-08523



10

GB Rechargeable work lamp  
 D Led Werkstattlampe  
 PL Diodowa lampa warsztatowa  
 RUS Светодиодная беспроводная лампа  
 CZ Montážní lampa diodová bezpřívodová  
 H Ledlampa  
 RO Lampa cu led fara cablu  
 E Lámpara inalámbrica de diodos

|   |  |
|---|--|
| <b>30/7 LED</b>                           | <b>13000 MCD</b>                           |
| <b>3.6V 1200mAh Ni-MH</b>                 | <b>230V~50Hz BATTERY CHARGER LADOVARKA</b> |
|   |  |
| <b>CHARGING TIME CZAS LADOWANIA 4-5 h</b> |  |
| <b>CE</b>                                 |  |



COLOR BOX

|             |    |
|-------------|----|
| <b>YATO</b> |    |
| YT-08505    | 10 |

GB Rechargeable work lamp  
 D Led Werkstattlampe  
 PL Diodowa lampa warsztatowa  
 RUS Светодиодная беспроводная лампа  
 CZ Montážní lampa diodová bezpřívodová  
 H Ledlampa  
 RO Lampa cu led fara cablu  
 E Lámpara inalámbrica de diodos

|   |  |
|---|--|
| <b>30/6 LED</b>                           | <b>13000 MCD</b>                           |
| <b>3.6V 1000mAh Ni-MH</b>                 | <b>230V~50Hz BATTERY CHARGER LADOVARKA</b> |
|   |  |
| <b>CHARGING TIME CZAS LADOWANIA 3-4 h</b> |  |
| <b>CE</b>                                 |  |



COLOR BOX

|             |    |
|-------------|----|
| <b>YATO</b> |    |
| YT-08512    | 12 |

GB Rechargeable work lamp  
 D Led Werkstattlampe  
 PL Diodowa lampa warsztatowa  
 RUS Светодиодная беспроводная лампа  
 CZ Montážní lampa diodová bezpřívodová  
 H Ledlampa  
 RO Lampa cu led fara cablu  
 E Lámpara inalámbrica de diodos

|                          |  |
|--------------------------|--|
| <b>60+1 LED</b>          | <b>13000 MCD</b>                           |
| <b>7.2V 800mAh Ni-MH</b> | <b>230V~50Hz BATTERY CHARGER LADOVARKA</b> |
|                          | <b>WATER PROOF ODPORNA NA WODE</b>         |
|                          | <b>CE</b>                                  |



DOUBLE BLISTER

|             |      |
|-------------|------|
| <b>YATO</b> |      |
| YT-0852     | 5/20 |

GB Under bonnet work led lamp  
 D Led Werkstattlampe  
 PL Diodowa lampa warsztatowa do oświetlania komory silnika  
 RUS Светодиодная беспроводная лампа  
 CZ Montážní lampa diodová bezpřívodová  
 H Ledlampa  
 RO Lampa cu led fara cablu  
 E Lámpara inalámbrica de diodos



|   |  |
|---|--|
| <b>120 LED</b>                            | <b>13000 MCD</b>                           |
| <b>7.2V 1800mAh Ni-MH</b>                 | <b>230V~50Hz BATTERY CHARGER LADOVARKA</b> |
|   |  |
|   |  |
| <b>CHARGING TIME CZAS LADOWANIA 4-5 h</b> |  |
| <b>CE</b>                                 |  |

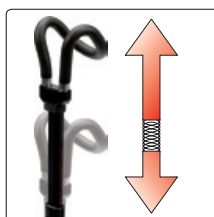
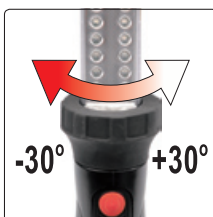

|             |   |
|-------------|---|
| <b>YATO</b> |   |
| YT-08530    | 4 |

COLOR BOX

GB Automotive circuit tester  
D KFZ Prüflampe  
PL Wskaźnik elektryczny samochodowy  
RUS Пробник напряжения автомобильный  
CZ Zkoušečka napětí autoelektrikářská

H Próbálampa  
RO Tester pt. circuite auto  
E Indicador eléctrico de coche



CABLE  
KABEL  
90 cm  
LED

6-24 V

6-12 V

|             |        |
|-------------|--------|
| <b>YATO</b> |        |
| YT-2865     | 10/250 |

|             |        |
|-------------|--------|
| <b>YATO</b> |        |
| YT-2866     | 10/100 |

GB Number stamp  
D Nummernstempel  
PL Znaczniki cyfrowe  
RUS Клейма цифровые  
CZ Razidla číselná  
H Számbeütők  
RO Poansoane cu cifre  
E Marcadores de números

9 PCS  
NUMBERS  
NUMERY  
0 - 9  
1045 CARBON STEEL  
HRC 50-55



PLASTIC BOX & COLOR SLEEVE

GB Letter stamp  
D Buchstabenstempel  
PL Znaczniki literowe  
RUS Клейма буквенные  
CZ Razidla písmenová  
H Betűbetűtők  
RO Poansoane cu litere  
E Marcadores de letras

27 PCS  
LETTERS  
LITERY  
A - Z &  
1045 CARBON STEEL  
HRC 50-55



PLASTIC BOX & COLOR SLEEVE

| <b>YATO</b> | No (mm) | PCS packing: |    |
|-------------|---------|--------------|----|
| YT-6854     | 6       | 9            | 20 |
| YT-6855     | 8       | 9            | 18 |

| <b>YATO</b> | No (mm) | PCS packing: |    |
|-------------|---------|--------------|----|
| YT-6862     | 6       | 27           | 12 |
| YT-6863     | 8       | 27           | 8  |

GB Thread repair set  
D Reparatursatz für Gewinde  
PL Zestaw do naprawy gwintów  
RUS Набор для ремонта резьбы  
CZ Souprava na opravu závitů  
H Menetjavító készlet  
RO Set pt. reparare filete  
E Juego para reparar roscas



HSS 4341  
STAINLESS STEEL  
STAL NERDZEWA

88 PCS

| <b>YATO</b> | size / rozmiar      |      |
|-------------|---------------------|------|
| YT-1769     | M6 x 1.0 x 10.8 mm  | 5/10 |
|             | M8 x 1.25 x 10.8 mm |      |
|             | M10 x 1.5 x 13.5 mm |      |



131 PCS

| <b>YATO</b> | size / rozmiar       |      |
|-------------|----------------------|------|
| YT-1763     | M5 x 0.8 x 6.7 mm    | 5/10 |
|             | M6 x 1.0 x 10.8 mm   |      |
|             | M8 x 1.25 x 10.8 mm  |      |
|             | M10 x 1.5 x 13.5 mm  |      |
|             | M12 x 1.75 x 16.3 mm |      |

GB Wire threads  
D Spiraleinlagen für Gewindereparatur  
PL Wkłady spiralne do naprawy gwintów  
RUS Метчики и сверла для ремонта резьбы

CZ Spirálové vložky na opravu závitů  
H Menetjavító betétek  
RO Inserții spirală pt. reparare filete  
E Elementos espirales para reparar roscas

POLYBAG WITH HEADER



for / dla: YT-1763, YT-1769

STAINLESS STEEL  
STAL NERDZEWA



| <b>YATO</b> | size / rozmiar       | PCS packing: |        |
|-------------|----------------------|--------------|--------|
| YT-1764     | M5 x 0.8 x 6.7 mm    | 20           | 50/250 |
| YT-1765     | M6 x 1.0 x 10.8 mm   | 20           | 50/250 |
| YT-1766     | M8 x 1.25 x 10.8 mm  | 20           | 50/200 |
| YT-1767     | M10 x 1.5 x 13.5 mm  | 15           | 25/100 |
| YT-1768     | M12 x 1.75 x 16.3 mm | 10           | 25/100 |

GB Foot pump with gauge  
 D Fusspumpe  
 PL Pompka nożna z manometrem  
 RUS Насос ножный с манометром

CZ Nožní pumpa z manometrem  
 H Lábpumpa nyomásmérővel  
 RO Pompă de picior cu manometru  
 E Bomba de pierna con manometro



GB Foot pump with gauge  
 D Fusspumpe  
 PL Pompka nożna dwutłokowa z manometrem  
 RUS Насос ножный с манометром  
 CZ Nožní pumpa z manometrem  
 H Lábpumpa nyomásmérővel  
 RO Pompă de picior cu manometru  
 E Bomba de pierna con manometro



**TWIN PISTON**  
**PODWÓJNY TŁOK**



COLOR BOX



COLOR BOX



**YATO**

YT-7349



10

**YATO**

YT-7350



10

GB Hand pump with manometer  
 D Hand-Luftpumpe mit Manometer  
 PL Pompka słupkowa z manometrem

RUS Насос ручной с манометром  
 CZ Pumpa z manometrem  
 H Kézi pumpa manométerrel

RO Pompa de mana cu manometru  
 E Bomba de barrote con manometro

PLASTIC HANGER  
 & TAG CARD



\* - product not for european market  
 \* - produkt nieprzeznaczony na rynek europejski

**YATO**

YT-7351\*



6

**YATO**

YT-7352



6

GB Funnel  
D Trichter  
PL Lejek  
RUS Воронка гибкая  
CZ Nálevka

H Kétrészes  
tölcsér  
RO Pálnie  
E Embudo

∅  
135mm  
PP



| YATO    | ∅ (mm) |     |
|---------|--------|-----|
| YT-0694 | 135    | 192 |

GB Long funnel  
D Trichter  
PL Lejek długi  
RUS Воронка гибкая  
CZ Nálevka  
H Kétrészes tölcsér  
RO Pálnie  
E Embudo

∅  
120mm  
PP



| YATO    | L (mm) | ∅ (mm) |    |
|---------|--------|--------|----|
| YT-0693 | 455    | 120    | 48 |

GB Operating  
fluids funnel  
D Trichter  
PL Lejek do płynów  
eksploatacyjnych  
RUS Воронка гибкая  
CZ Nálevka  
H Kétrészes tölcsér  
RO Pálnie  
E Embudo

∅  
100mm  
PP



| YATO    | ∅ (mm) |     |
|---------|--------|-----|
| YT-0695 | 100    | 180 |

GB Operating  
fluids funnel  
D Trichter  
PL Lejek do płynów  
eksploatacyjnych  
RUS Воронка гибкая  
CZ Nálevka  
H Kétrészes tölcsér  
RO Pálnie  
E Embudo

∅  
240mm  
PP



| YATO    | ∅ (mm) |    |
|---------|--------|----|
| YT-0696 | 240    | 48 |

GB Fuel and oil  
funnel  
D Trichter  
PL Lejek do paliwa i oleju  
eksploatacyjnych  
RUS Воронка гибкая  
CZ Nálevka  
H Kétrészes tölcsér  
RO Pálnie  
E Embudo

∅  
150mm  
PP



| YATO    | ∅ (mm) |    |
|---------|--------|----|
| YT-0692 | 150    | 30 |

GB Oil funnel  
D Trichter  
PL Lejek do oleju  
RUS Воронка гибкая  
CZ Nálevka  
H Kétrészes tölcsér  
RO Pálnie  
E Embudo

∅  
280mm  
PP



| YATO    | ∅ (mm) |    |
|---------|--------|----|
| YT-0697 | 280    | 48 |

GB Oil drain pan  
D Ölwanne  
PL Miska do oleju  
RUS Миска для масла  
CZ Miska na olej  
H Fáradtolaj felfogó  
edény  
RO Recipient pt. ulei  
E Escudilla  
para aceite

PP



| YATO    | l | ∅ (cm) |    |
|---------|---|--------|----|
| YT-0699 | 8 | 37     | 48 |

GB Oil drainer  
D Öleinfüllanlage  
PL Zlewarka do oleju  
RUS Устройство  
для слива масла  
CZ Olejová nádrž s odsávaním  
H Fáradtolaj leszívó  
RO Dispozitiv pt. schimbat ulei  
E Decantador para aceite

75-155  
cm PE



WHITE CARTON BOX  
& COLOR LABEL



| YATO    | l  | ∅ (cm) |   |
|---------|----|--------|---|
| YT-0716 | 10 | 37     | 6 |
| YT-0717 | 15 | 42     | 4 |

| YATO    | l  | ∅ (cm) |   |
|---------|----|--------|---|
| YT-0718 | 20 | 42     | 1 |

GB Hydraulic bottle jack  
 D Hydraulischer Stempelwagenheber  
 PL Podnośnik hydrauliczny słupkowy  
 RUS Домкрат гидравлический  
 CZ Pistový zvedák hydraulický  
 H Hidraulikus emelő  
 RO Cric hidraulic  
 E Gato de embolo hidr.

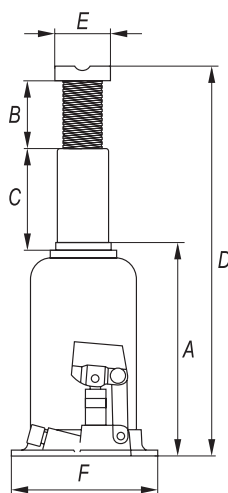

ELECTROLESS  
NICKEL  
PLATING



COLOR BOX



| YATO    | T  | A (mm) | B (mm) | C (mm) | D (mm) | E (mm) | F (mm)    |   |
|---------|----|--------|--------|--------|--------|--------|-----------|---|
| YT-1702 | 5  | 212    | 110    | 146    | 468    | 40     | 110x112   | 5 |
| YT-1704 | 10 | 220    | 115    | 148    | 483    | 48     | 124x127.5 | 3 |
| YT-1706 | 15 | 231    | 113    | 154    | 498    | 56     | 140x142   | 2 |
| YT-1707 | 20 | 241    | 115    | 165    | 521    | 60     | 165x161   | 2 |
| YT-1709 | 30 | 244    | 108    | 140    | 492    | 65     | 186x174   | 1 |

GB Two-piston hydraulic bottle jack  
 D Hydraulischer Stempelwagenheber  
 PL Podnośnik hydrauliczny słupkowy dwutłokowy  
 RUS Домкрат гидравлический  
 CZ Pistový zvedák hydraulický  
 H Hidraulikus emelő  
 RO Cric hidraulic  
 E Gato de embolo hidr.

COLOR BOX



ELECTROLESS  
NICKEL  
PLATING



5t

500  
↑  
220 mm

10t

225  
↑  
125 mm



| YATO    | T |   |
|---------|---|---|
| YT-1711 | 5 | 2 |

| YATO    | T  |   |
|---------|----|---|
| YT-1713 | 10 | 2 |

16



10t

523  
↑  
208 mm

12t

593  
↑  
230 mm



| YATO    | T  |   |
|---------|----|---|
| YT-1714 | 10 | 1 |

| YATO    | T  |   |
|---------|----|---|
| YT-1715 | 12 | 1 |

- GB Hydraulic floor jack  
D Hydraulischer Rangierwagenheber  
PL Podnośnik hydrauliczny  
RUS Домкрат гидравлический  
CZ Pístový zvedák hydraulický  
H Hidraulikus emelő  
RO Cric tip crocodil  
E Gato de embolo hidr.



LOW PROFILE CE

1.25t

375 mm  
↓  
80 mm

AI

COLOR BOX



|             |      |   |
|-------------|------|---|
| <b>YATO</b> | T    |   |
| YT-1719     | 1.25 | 1 |



2t

359 mm  
↓  
89 mm

BMC & COLOR SLEEVE



|             |   |   |
|-------------|---|---|
| <b>YATO</b> | T |   |
| YT-1720     | 2 | 1 |



2.5t

457 mm  
↓  
89 mm

COLOR BOX



|             |     |   |
|-------------|-----|---|
| <b>YATO</b> | T   |   |
| YT-1721     | 2.5 | 1 |

- GB Work bench  
D Lackierständer, verstellbar  
PL Stojak lakierniczy rozstawny  
RUS Раздвижная лакировочная стойка  
CZ Stojan lakovnický rozkládací  
H Kinyitható lakkozó állvány  
RO Suport extensibil pt. lacuit  
E Montante plegable para barnizar



10 kg max  
85 cm  
50 cm

150 kg max  
45 cm  
100 cm

16



COLOR BOX

|             |   |
|-------------|---|
| <b>YATO</b> |   |
| YT-5555     | 1 |

GB Electronic battery charger  
 D Elektronisches Ladegerät  
 PL Prostownik elektroniczny  
 RUS Электронное зарядное устройство  
 CZ Elektronická nabíječka  
 H Elektronikus akkumulátortöltő  
 RO Redresor electric  
 E Rectificador electrónico



COLOR BOX



|                |                  |
|----------------|------------------|
| 6 V            | 1 A              |
| 12 V           | 4 A              |
| 200 Ah max     | 230V~50Hz        |
| WET GEL AGM    | MOKRY ZELOWY AGM |
| MICROPROCESSOR | CE               |

|             |   |
|-------------|---|
| <b>YATO</b> |   |
| YT-8300     | 8 |



|                |                  |
|----------------|------------------|
| 230V~50Hz      | 5-160 Ah         |
| 2 A            | 12 V             |
| 8 A            |                  |
| WET GEL AGM    | MOKRY ZELOWY AGM |
| MICROPROCESSOR | CE               |



|                |                  |
|----------------|------------------|
| 6 V            | 8 A              |
| 12 V           |                  |
| 5-200 Ah       | 230V~50Hz        |
| WET GEL AGM    | MOKRY ZELOWY AGM |
| MICROPROCESSOR | CE               |

|             |    |
|-------------|----|
| <b>YATO</b> |    |
| YT-83016    | 12 |

|             |   |
|-------------|---|
| <b>YATO</b> |   |
| YT-8301     | 8 |

GB Electronic battery charger  
 D Elektronisches Ladegerät  
 PL Prostownik elektroniczny  
 RUS Электронное зарядное устройство  
 CZ Elektronická nabíječka  
 H Elektronikus akkumulátortöltő  
 RO Redresor electric  
 E Rectificador electrónico

COLOR BOX



|                |           |
|----------------|-----------|
| 12 V           | 12 A      |
| 6-200 Ah       | 230V~50Hz |
| MICROPROCESSOR | WET MOKRY |
| CE             |           |

|                |                  |
|----------------|------------------|
| 12 V           | 15 A             |
| 6-200 Ah       | 230V~50Hz        |
| WET GEL AGM    | MOKRY ZELOWY AGM |
| MICROPROCESSOR | CE               |

|             |   |
|-------------|---|
| <b>YATO</b> |   |
| YT-8302     | 8 |

|             |   |
|-------------|---|
| <b>YATO</b> |   |
| YT-8303     | 8 |



GB Battery charger  
D Ladegerät  
PL Prostownik

RUS Зарядное устройство  
CZ Nabíječka

H Akkumulátortöltő  
RO Redresor  
E Rectificador

COLOR  
BOX



230V~  
50Hz

12V  
24V





16 A

120-240  
Ah

WET  
MOKRY

25 A

170-350  
Ah

WET  
MOKRY

**YATO**    
YT-8304 2

**YATO**    
YT-8305 2



15 A

10-300  
Ah

WET  
MOKRY  
AGM

BOOST  
ROZRUCH  
12V 75A

 MICROPROCESSOR

30 A

50-600  
Ah

WET  
MOKRY  
AGM

BOOST  
ROZRUCH  
12V 145A

 MICROPROCESSOR

**YATO**    
YT-83051 2

**YATO**    
YT-83052 2

GB Battery charger with a starter  
D Ladegerät mit starterfunktion  
PL Prostownik z rozruchem  
RUS Выпрямитель с функцией запуска

CZ Nabíječka s funkcí startování motoru  
H Akkumulátortöltő - indító  
RO Redresor cu pornire  
E Rectificador con arranque

GREY  
CARTON BOX  
WITH COLOUR  
LABEL



230V~  
50Hz

WET  
MOKRY





12V 27A  
STARTI ROZRUCH  
300A

24V 25A  
STARTI ROZRUCH  
240A

20-600  
Ah

12V 32A  
STARTI ROZRUCH  
390A

24V 31A  
STARTI ROZRUCH  
360A

20-700  
Ah

12V 38A  
STARTI ROZRUCH  
540A

24V 35A  
STARTI ROZRUCH  
450A

20-800  
Ah

**YATO**    
YT-83060 1

**YATO**    
YT-83061 1

**YATO**    
YT-83062 1

- |                        |                      |
|------------------------|----------------------|
| GB Jumpstart wires     | CZ Startovací kabely |
| D Starterkabel         | H Indító kábelek     |
| PL Przewody rozruchowe | RO Cabluri demarare  |
| RUS Пусковые провода   | E Cables de arranque |

WINDOW BAG  
WITH ZIPPER



2.5m



| YATO     | rated load / obciążenie nominalne (A) |    |
|----------|---------------------------------------|----|
| YT-83150 | 120                                   | 20 |
| YT-83151 | 200                                   | 12 |

| YATO     | rated load / obciążenie nominalne (A) |    |
|----------|---------------------------------------|----|
| YT-83152 | 400                                   | 12 |
| YT-83153 | 600                                   | 12 |

- GB Analogue battery tester  
D Analoges Batterieprüfgerät  
PL Tester akumulatorów analogowy  
RUS Аналоговый тестер аккумуляторов  
CZ Analogový tester akumulátorů  
H Analóg akkuteszter  
RO Tester acumulatori analog  
E Tester analógico para acumuladores

6V

12V

CCA  
200-  
1000 A



COLOR BOX



|         |  |    |
|---------|--|----|
| YATO    |  |    |
| YT-8310 |  | 10 |

- GB Digital battery tester  
D Digitales Batterieprüfgerät  
PL Tester akumulatorów cyfrowy  
RUS Цифровой тестер аккумуляторов  
CZ Digitální tester akumulátorů  
H Digitális akkuteszter  
RO Tester acumulatori digital  
E Tester digital para acumuladores

12V

LED  
DISPLAY

CCA  
150-  
1400 A



COLOR BOX



|         |  |    |
|---------|--|----|
| YATO    |  |    |
| YT-8311 |  | 10 |

- GB Battery tester  
D Batterieprüfgerät  
PL Tester akumulatorów  
RUS Тестер аккумуляторов  
CZ Tester akumulátorů  
H Akkuteszter  
RO Tester acumulatori  
E Tester para acumuladores

12V

BATTERY  
TEST  
TEST  
AKUMULATORA

ALTERNATOR  
TEST  
TEST  
ALTERNATORA



DOUBLE BLISTER



|          |  |       |
|----------|--|-------|
| YATO     |  |       |
| YT-83101 |  | 12/72 |

- GB Chain block  
D Kettenzug Flaschenzug  
PL Wyciągarka łańcuchowa  
RUS Таль цепная  
CZ Zvedák řetězový  
H Láncos csigásor emelő  
RO Scripete cu lant  
E Cabria de cadena

COLOR BOX



- GB Electric hoist  
D Elektro-Seilwinde  
PL Elektryczna wciągarka linowa  
RUS Электрическая канатная лебедка  
CZ Elektrický naviják kladkostroj  
H Elektromos csőrő  
RO Troliu electric cu cablu  
E Cabria eléctrica de cuerdas

~230V  
50Hz



COLOR BOX



|             |   |         |             |   |         |
|-------------|---|---------|-------------|---|---------|
| <b>YATO</b> |   |         | <b>YATO</b> |   |         |
| YT-5890     | 1 | 500 kg  | YT-5893     | 1 | 2000 kg |
| <b>YATO</b> |   |         | <b>YATO</b> |   |         |
| YT-5892     | 1 | 1000 kg | YT-5894     | 1 | 3000 kg |

|             |   |        |        |             |   |        |        |
|-------------|---|--------|--------|-------------|---|--------|--------|
| <b>YATO</b> |   |        |        | <b>YATO</b> |   |        |        |
| YT-5901     | 2 | 125 kg | 250 kg | YT-5904     | 2 | 250 kg | 500 kg |
| <b>YATO</b> |   |        |        | <b>YATO</b> |   |        |        |
| YT-5902     | 2 | 150 kg | 300 kg | YT-5905     | 2 | 300 kg | 600 kg |

- GB Rope winch  
D Handseilwinde  
PL Wyciągarka linowa  
RUS Канатная лебедка
- CZ Lanové vyťahovací zařízení  
H Drótköteles csőrő  
RO Troliu cu cablu orizontal  
E Cabria de cuerdas

COLOR BOX



1000 daN

| <b>YATO</b> | daN  | L (m) | Ø (mm) |   |
|-------------|------|-------|--------|---|
| YT-5911     | 1000 | 3     | 5      | 6 |



1300 daN

| <b>YATO</b> | daN  | L (m) | Ø (mm) |   |
|-------------|------|-------|--------|---|
| YT-5913     | 1300 | 3     | 5      | 6 |



1500 daN

| <b>YATO</b> | daN  | L (m) | Ø (mm) |   |
|-------------|------|-------|--------|---|
| YT-5914     | 1500 | 3     | 6      | 3 |

# 17

## Power & gasoline tools Elektronarzędzia i narzędzia spalinowe



Hot air guns  
Opalarki

334



Electric hoists  
Elektryczne wciągarki linowe

336



Pumps  
Pompy

335



Burners & soldering tools  
Palniki i lutownice

336-337



Compressors  
Kompresory

335



Glue guns  
Pistolety do klejenia

338



GB Hot air gun  
 D Heissluftpistole  
 PL Opalarka  
 RUS Фен для обжигания краски  
 CZ Opalovací stroj  
 H Hőlégfúvó  
 RO Fion pt. ars vopseaua  
 E Secadora

230V~  
50Hz

2000  
W

550°C

500  
l/min

CE



COLOR BOX

**YATO**

YT-82288



10

GB Hot air gun with accessories  
 D Heissluftpistole  
 PL Opalarka z akcesoriami  
 RUS Фен для обжигания краски в наборе  
 CZ Opalovací stroj s příslušenstvím  
 H Hőlégfúvó tartozékokkal  
 RO Fion cu accesorii pt. ars vopseaua  
 E Secadora con accesorios

230V~  
50Hz

2000  
W

550°C

500  
l/min

CE



BMC & COLOR SLEEVE

**YATO**

YT-82291



5

GB Hot air gun with accessories  
 D Heissluftpistole  
 PL Opalarka z akcesoriami  
 RUS Фен для обжигания краски в наборе  
 CZ Opalovací stroj s příslušenstvím  
 H Hőlégfúvó tartozékokkal  
 RO Fion cu accesorii pt. ars vopseaua  
 E Secadora con accesorios

230V~  
50Hz

2000  
W

550°C

500  
l/min

LED

CE

TEMPERATURE  
ADJUSTMENT



REGULACJA  
TEMPERATURY

GB Hot air gun with accessories  
 D Heissluftpistole  
 PL Opalarka z akcesoriami  
 RUS Фен для обжигания краски в наборе  
 CZ Opalovací stroj s příslušenstvím  
 H Hőlégfúvó tartozékokkal  
 RO Fion cu accesorii pt. ars vopseaua  
 E Secadora con accesorios

230V~  
50Hz

2000  
W

600°C

500  
l/min

LCD DISPLAY

CE

TEMPERATURE  
ADJUSTMENT



REGULACJA  
TEMPERATURY



BMC & COLOR SLEEVE

**YATO**

YT-82292



5



BMC & COLOR SLEEVE

**YATO**

YT-82293



5

GB Gasoline water pump  
D Pumpe mit verbrennungsmotor  
PL Pompa spalinowa  
RUS Бензонасос  
CZ Čerpadlo  
se spalovacím motorem  
H Robbanómotoros szivattyú  
RO Pompa cu motor  
cu ardere interna  
E Bomba de combustion



COLOR BOX



**YATO**  
YT-85401 1

GB Gasoline water pump  
D Pumpe mit verbrennungsmotor  
PL Pompa spalinowa  
RUS Бензонасос  
CZ Čerpadlo  
se spalovacím motorem  
H Robbanómotoros szivattyú  
RO Pompa cu motor  
cu ardere interna  
E Bomba de combustion



COLOR BOX



**YATO**  
YT-85402 1

GB Gasoline water pump  
D Pumpe mit verbrennungsmotor  
PL Pompa spalinowa  
RUS Бензонасос  
CZ Čerpadlo  
se spalovacím motorem  
H Robbanómotoros szivattyú  
RO Pompa cu motor  
cu ardere interna  
E Bomba de combustion



COLOR BOX



**YATO**  
YT-85403 1

GB Oil type piston compressor  
D Druckluft Kompressor ölhaltig  
PL Kompressor olejowy  
RUS Масляный компрессор  
CZ Kompressor vzduchový olejový  
H Kompresszor, olajos, fekvő tartályos  
RO Compressor aer cu ulei  
E Compressor de aire comprimido



GREY  
CARTON BOX



**YATO**  
YT-23220 1

- GB Electric hoist
- D Elektro-Seilwinde
- PL Elektryczna wciągarka linowa
- RUS Электрическая канатная лебёдка
- CZ Elektrický naviják kladkostroj
- H Elektromos csőrő
- RO Troliu electric cu cablu
- E Cabría eléctrica de cuerdas



COLOR BOX



|               |    |        |        |
|---------------|----|--------|--------|
| ~230V<br>50Hz | CE |        |        |
| 500W          |    |        |        |
| YATO          |    |        |        |
| YT-5901       | 2  | 125 kg | 250 kg |
| 550W          |    |        |        |
| YATO          |    |        |        |
| YT-5902       | 2  | 150 kg | 300 kg |
| 900W          |    |        |        |
| YATO          |    |        |        |
| YT-5904       | 2  | 250 kg | 500 kg |
| 1050W         |    |        |        |
| YATO          |    |        |        |
| YT-5905       | 2  | 300 kg | 600 kg |

- GB Butane torch
- D Gasbrenner
- PL Palnik gazowy
- RUS Газовая горелка
- CZ Plynový hořák
- H Gázégő
- RO Arzător de gaz
- E Soplete de gas

PIEZO ELECTRIC 1350°C 60ml 200 min



HANGING COLOR BOX



YATO  
YT-6700 6/24

- GB Butane soldering tool
- D GaslötKolben
- PL Lutownica gazowa
- RUS Паяльник газовый
- CZ Plynová pájka

- H Forrasztópisztoly ceruza
- RO Surubelnita sudura cu gaz
- E Microsoldador de butano portátil



1300°C 210-400°C 20ml 25-80 W 120 min

YATO  
YT-6705 12/72



PIEZO ELECTRIC 1300°C 250-550°C 38ml 30-125 W 200 min

YATO  
YT-6706 12/48



GB Soldering iron  
D LötKolben  
PL Lutownica oporowa

RUS Электропаяльник  
CZ Pájka odporová  
H Forrasztópáka

RO Ciocan de lipit  
E Soldador de resistencia

HANGING  
DISPLAY  
COLOR BOX

230V~  
50Hz



| YATO    | W  | working temp. of soldering tip (°C) | dimensions of soldering tip (mm) |    |
|---------|----|-------------------------------------|----------------------------------|----|
| YT-8271 | 30 | 400                                 | ø3.8 x 70                        | 16 |
| YT-8272 | 60 | 500                                 | ø6.0 x 78                        | 16 |
| YT-8273 | 80 | 520                                 | ø6.8 x 64                        | 16 |

GB Soldering iron  
D LötKolben  
PL Lutownica oporowa

RUS Электропаяльник  
CZ Pájka odporová  
H Forrasztópáka

RO Ciocan de lipit  
E Soldador de resistencia

SLIDING  
CARD

230V~  
50Hz



| YATO     | W  | working temp. of soldering tip (°C) | dimensions of soldering tip (mm) |      |
|----------|----|-------------------------------------|----------------------------------|------|
| YT-8250* | 30 | 300                                 | R0.3 x ø3.8 x 70.8               | 6/60 |
| YT-8251* | 40 | 320                                 | R0.5 x ø4.9 x 75.5               | 6/60 |
| YT-8252* | 50 | 340                                 | R0.5 x ø5.9 x 76.5               | 6/60 |
| YT-8253* | 60 | 350                                 | R0.5 x ø5.9 x 76.5               | 6/60 |

| YATO     | W  | working temp. of soldering tip (°C) | dimensions of soldering tip (mm) |      |
|----------|----|-------------------------------------|----------------------------------|------|
| YT-8254* | 15 | 300                                 | R0.3 x ø6.4 x 42.7               | 6/60 |
| YT-8255* | 25 | 320                                 | R0.3 x ø6.4 x 42.7               | 6/60 |
| YT-8256* | 35 | 350                                 | R0.5 x ø8.0 x 57.0               | 6/60 |

GB Heater core  
D Heizeinsatz  
PL Wkład grzejny  
RUS Обогревательный вкладыш

CZ Topná vložka  
H Fűtőbetét  
RO Cartuş de încălzit  
E Elemento de calentamiento

POLYBAG  
& COLOR  
LABEL



| YATO     | W  | working temp. of soldering tip (°C) | dimensions of soldering tip (mm) | for / dla |        |
|----------|----|-------------------------------------|----------------------------------|-----------|--------|
| YT-8257* | 30 | 400                                 | ø3.8 x 70.8                      | YT-8250   | 20/200 |
| YT-8258* | 40 | 420                                 | ø4.9 x 75.5                      | YT-8251   | 20/200 |
| YT-8259* | 50 | 440                                 | ø5.9 x 76.5                      | YT-8252   | 20/200 |
| YT-8260* | 60 | 450                                 | ø5.9 x 76.5                      | YT-8253   | 20/200 |

\* - product not for european market  
\* - produkt nieprzeznaczony na rynek europejski



| YATO     | W  | working temp. of soldering tip (°C) | dimensions of soldering tip (mm) | for / dla |        |
|----------|----|-------------------------------------|----------------------------------|-----------|--------|
| YT-8261* | 15 | 400                                 | ø6.4 x 42.7                      | YT-8254   | 20/200 |
| YT-8262* | 25 | 420                                 | ø6.4 x 42.7                      | YT-8255   | 20/200 |
| YT-8263* | 35 | 450                                 | ø8.0 x 57.0                      | YT-8256   | 20/200 |

\* - product not for european market  
\* - produkt nieprzeznaczony na rynek europejski

GB Soldering tip  
D Lötspitze  
PL Grot do lutownicy

RUS Наконечник паяльника  
CZ Hrot do letovačky  
H Pákahegy  
RO Vârft pt. ciocanul de lipit  
E Pico soldador

POLYBAG  
& COLOR  
LABEL



| YATO     | W  | working temp. of soldering tip (°C) | dimensions of soldering tip (mm) | for / dla |        |
|----------|----|-------------------------------------|----------------------------------|-----------|--------|
| YT-8264* | 30 | 400                                 | R0.3 x ø3.8 x 70.8               | YT-8250   | 10/100 |
| YT-8265* | 40 | 420                                 | R0.5 x ø4.9 x 75.5               | YT-8251   | 10/100 |
| YT-8266* | 50 | 440                                 | R0.5 x ø5.9 x 76.5               | YT-8252   | 10/100 |
| YT-8267* | 60 | 450                                 | R0.5 x ø5.9 x 76.5               | YT-8253   | 10/100 |

\* - product not for european market  
\* - produkt nieprzeznaczony na rynek europejski



| YATO     | W  | working temp. of soldering tip (°C) | dimensions of soldering tip (mm) | for / dla |        |
|----------|----|-------------------------------------|----------------------------------|-----------|--------|
| YT-8268* | 15 | 400                                 | R0.3 x ø6.4 x 42.7               | YT-8254   | 20/200 |
| YT-8269* | 25 | 420                                 | R0.3 x ø6.4 x 42.7               | YT-8255   | 20/200 |
| YT-8270* | 35 | 450                                 | R0.5 x ø8.0 x 57.0               | YT-8256   | 20/200 |

\* - product not for european market  
\* - produkt nieprzeznaczony na rynek europejski

GB Transformer soldering gun  
D Lötpestole  
PL Lutownica transformatorowa  
RUS Паяльник электрический  
CZ Transformátorová páječka  
H Forrasztópáka  
RO Aparat de lipit letcon cu transformator  
E Soldador transformador



230V~  
50Hz

180  
W



BMC  
& COLOR  
SLEEVE



| YATO    | W   |    |
|---------|-----|----|
| YT-8245 | 180 | 10 |

- GB Electric glue gun
- D Heissklebepistole
- PL Pistolet do klejenia
- RUS Пистолет для клея
- CZ Pistole na lepení
- H Ragasztópisztoly
- RO Pistol pt. lipit
- E Pistola de cola



|               |                  |            |
|---------------|------------------|------------|
| 230V~<br>50Hz | 35<br>(400)<br>W | ∅<br>11 mm |
|               |                  |            |



| YATO     | W        |       |
|----------|----------|-------|
| YT-82401 | 35 (400) | 12/24 |

- GB Electric glue gun
- D Heissklebepistole
- PL Pistolet do klejenia
- RUS Пистолет для клея
- CZ Pistole na lepení
- H Ragasztópisztoly
- RO Pistol pt. lipit
- E Pistola de cola



|               |            |
|---------------|------------|
| 230V~<br>50Hz | ∅<br>11 mm |
|               |            |



| YATO     | W  |       |
|----------|----|-------|
| YT-8240* | 40 | 12/48 |
| YT-8241* | 60 | 12/48 |

\* - product not for european market  
\* - produkt nieprzeznaczony na rynek europejski

- GB Cordless glue gun
- D Heissklebepistole
- PL Akumulatorowy  
pistolet do klejenia
- RUS Пистолет для клея
- CZ Pistole na lepení
- H Ragasztópisztoly
- RO Pistol pt. lipit
- E Pistola de cola



|                     |        |    |
|---------------------|--------|----|
| 7.4 V<br>2.6 Ah<br> | Li-Ion | 8W |
| ∅<br>11 mm          |        |    |



| YATO     | W |      |
|----------|---|------|
| YT-82421 | 8 | 6/24 |

Memo

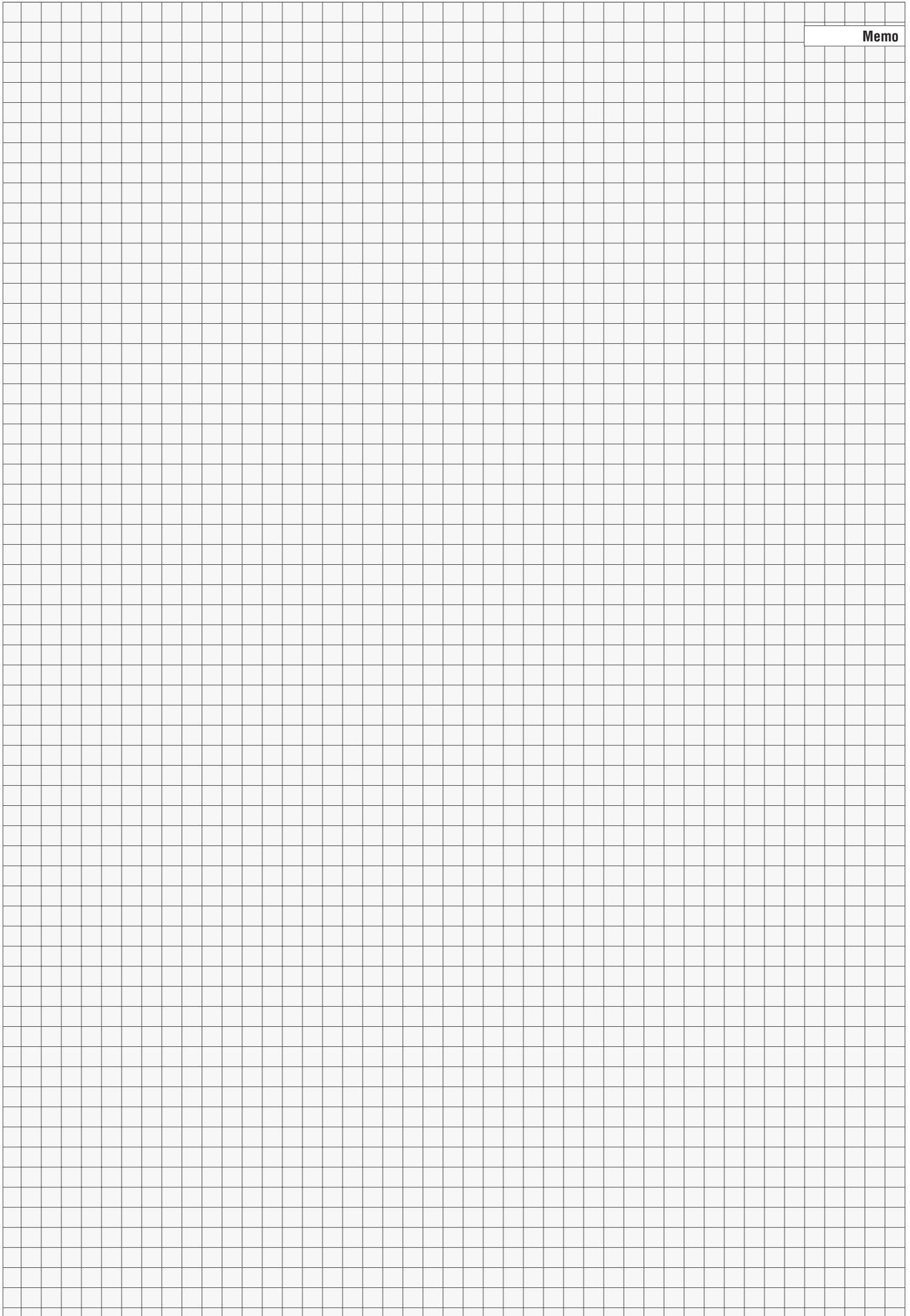

# 18

## Padlocks & lock cylinders Kłódki i wkładki do zamków



Brass padlocks  
Kłódki mosiężne

342

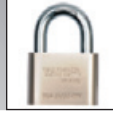

Lock cylinders  
Wkładki do zamków

343



Arbor padlocks  
Kłódki trzpieniowe

342



Brass lock cylinders

Wkładki mosiężne..... 343

Brass lock cylinders with knob

Wkładki mosiężne z gałką..... 343

GB Brass padlock  
 D Vorhängeschloss  
 PL Klódka mosiężna  
 RUS Стержневой навесной латунный  
 CZ Zámek visací mosazný  
 H Lakat sárgaréz  
 RO Lacat alama  
 E Candado de latón

4xT BRASS MOSIĄDZ



DOUBLE BLISTER

| YATO    | L (mm) |      |
|---------|--------|------|
| YT-6960 | 40     | 6/72 |
| YT-6961 | 50     | 6/48 |
| YT-6962 | 60     | 6/36 |

GB Brass padlock  
 D Vorhängeschloss  
 PL Klódka mosiężna  
 RUS Стержневой навесной латунный  
 CZ Zámek visací mosazný  
 H Lakat sárgaréz  
 RO Lacat alama  
 E Candado de latón

4xT BRASS MOSIĄDZ



DOUBLE BLISTER

| YATO    | L (mm) |      |
|---------|--------|------|
| YT-6963 | 30     | 6/96 |
| YT-6964 | 40     | 6/72 |
| YT-6965 | 50     | 6/60 |
| YT-6966 | 60     | 6/36 |

GB Arbor brass padlock  
 D Vorhängeschloss  
 PL Klódka trzpieniowa  
 RUS Стержневой навесной замок чугунный  
 CZ Stavební visací zámek  
 H Óriás lakat  
 RO Lacăt  
 E Candado de mandril de hierro fundido cubierto

4xT BRASS MOSIĄDZ



DOUBLE BLISTER

| YATO    | L (mm) |      |
|---------|--------|------|
| YT-6980 | 40     | 6/96 |
| YT-6981 | 50     | 6/72 |
| YT-6982 | 60     | 6/60 |
| YT-6983 | 70     | 6/36 |
| YT-6984 | 80     | 6/30 |
| YT-6985 | 90     | 6/24 |

GB Arbor brass padlock  
 D Vorhängeschloss  
 PL Klódka trzpieniowa  
 RUS Стержневой навесной замок чугунный  
 CZ Stavební visací zámek  
 H Óriás lakat  
 RO Lacăt  
 E Candado de mandril de hierro fundido cubierto

4xT BRASS MOSIĄDZ



DOUBLE BLISTER

| YATO    | L (mm) |      |
|---------|--------|------|
| YT-6986 | 40     | 6/48 |
| YT-6987 | 50     | 6/48 |
| YT-6988 | 60     | 6/48 |
| YT-6989 | 70     | 6/24 |

GB Lock cylinder  
D Schliesszylinder  
PL Wkładka do zamka  
RUS Замок цилиндрический  
CZ Vložka na zámek  
H Zárbetét  
RO Yală pt. broască  
E Inserción de latón

BRASS  
MOSIĄDZ

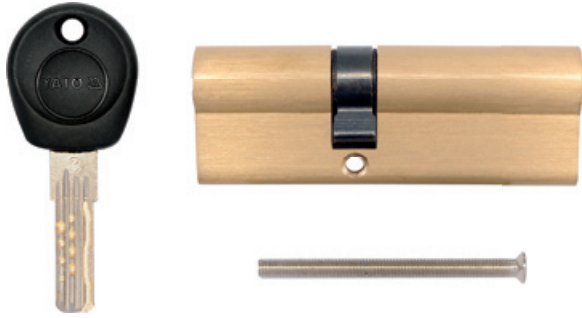



Lock cylinder received „Test Certificate”  
issued by Instytut Techniki Budowlanej

Wkładka posiada „Świadectwo Badań”  
wystawione przez Instytut Techniki Budowlanej

COLOR BOX  
& MESH  
PLASTIC TRAY



| YATO  | L (mm) | mm    |  |
|--|--------|-------|---|
| YT-69900   | 62     | 31/31 | 12/60   |
| YT-69901   | 67     | 31/36 | 12/60   |
| YT-69902   | 72     | 31/41 | 12/60   |
| YT-69903   | 87     | 36/51 | 12/60   |

GB Lock cylinder  
D Schliesszylinder  
PL Wkładka do zamka  
RUS Замок цилиндрический  
CZ Vložka na zámek  
H Zárbetét  
RO Yală pt. broască  
E Inserción de latón

BRASS  
MOSIĄDZ

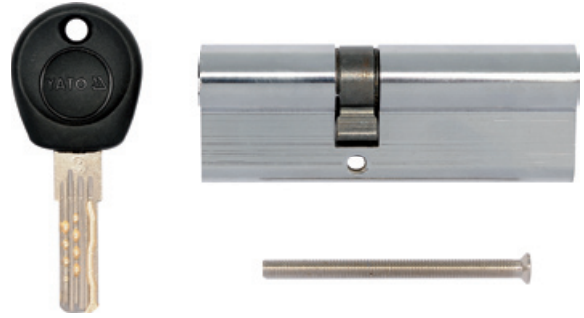



Lock cylinder received „Test Certificate”  
issued by Instytut Techniki Budowlanej

Wkładka posiada „Świadectwo Badań”  
wystawione przez Instytut Techniki Budowlanej

COLOR BOX  
& MESH  
PLASTIC TRAY



| YATO  | L (mm) | mm    |  |
|--|--------|-------|---|
| YT-69905   | 62     | 31/31 | 12/60   |
| YT-69906   | 67     | 31/36 | 12/60   |
| YT-69907   | 72     | 31/41 | 12/60   |
| YT-69908   | 87     | 36/51 | 12/60   |

GB Lock cylinder  
D Schliesszylinder  
PL Wkładka do zamka  
RUS Замок цилиндрический  
CZ Vložka na zámek  
H Zárbetét  
RO Yală pt. broască  
E Inserción de latón

BRASS  
MOSIĄDZ

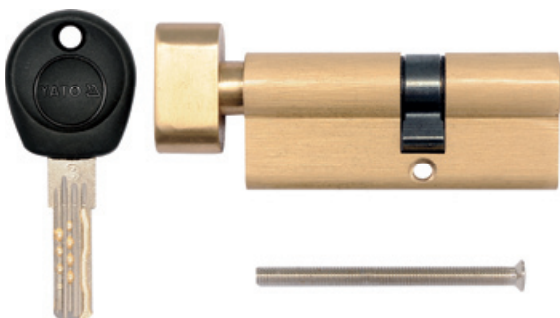



Lock cylinder received „Test Certificate”  
issued by Instytut Techniki Budowlanej

Wkładka posiada „Świadectwo Badań”  
wystawione przez Instytut Techniki Budowlanej

COLOR BOX  
& MESH  
PLASTIC TRAY



| YATO  | L (mm) | mm    |  |
|---|--------|-------|---|
| YT-69910  | 62     | 31/31 | 12/60   |
| YT-69911  | 67     | 31/36 | 12/60   |
| YT-69912  | 67     | 36/31 | 12/60   |
| YT-69913  | 72     | 31/41 | 12/60   |
| YT-69914  | 72     | 41/31 | 12/60   |

GB Lock cylinder  
D Schliesszylinder  
PL Wkładka do zamka  
RUS Замок цилиндрический  
CZ Vložka na zámek  
H Zárbetét  
RO Yală pt. broască  
E Inserción de latón

BRASS  
MOSIĄDZ

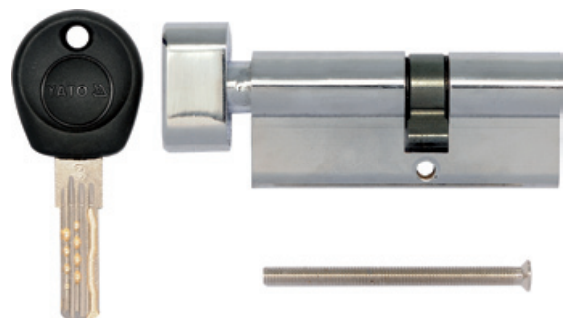



Lock cylinder received „Test Certificate”  
issued by Instytut Techniki Budowlanej

Wkładka posiada „Świadectwo Badań”  
wystawione przez Instytut Techniki Budowlanej

COLOR BOX  
& MESH  
PLASTIC TRAY



| YATO  | L (mm) | mm    |  |
|--|--------|-------|---|
| YT-69920   | 62     | 31/31 | 12/60   |
| YT-69921   | 67     | 31/36 | 12/60   |
| YT-69922   | 67     | 36/31 | 12/60   |
| YT-69923   | 72     | 31/41 | 12/60   |
| YT-69924   | 72     | 41/31 | 12/60   |

# 19

## Accessories Akcesoria





Tool belts  
Pasy na narzędzia

346



Tool pockets  
Kieszenie na narzędzia

346-347



Tool sleeveless jackets  
Kamizelki monterskie

346



Tool bags & knapsacks  
Torby i plecaki narzędziowe

347



- GB** Heavy duty nail & tool pouch  
**D** Werkzeuggürtel mit Nägel- und Schraubenlaschen  
**PL** Pas z kieszeniami na gwoździe i narzędzia  
**RUS** Ремень с сумками для гвоздей и инструментов  
**CZ** Pás na nářadí pětikapsový  
**H** Szeg és szerszámtartó öv  
**RO** Centura port scule  
**E** Cinturón porta herramientas y accesorios varios



**21**  
POCKETS  
KIESZENI

**120**  
cm

HEAVY  
DUTY  
NYLON

COLOR  
BOX



**5**  
POCKETS

HEAVY  
DUTY  
NYLON

**510x600**  
mm



COLOR BOX



**COWHIDE BELT**



**YATO**

YT-7400



10

- GB** Tool sleeveless jacket  
**D** Monteurweste  
**PL** Kamizelka monterska  
**RUS** Безрукавка монтажника  
**CZ** Vesta montéřská s kapsami na nářadí  
**H** Szerszámos mellény  
**RO** Vesta port scule  
**E** Chaleco de montador



- \* - product not for european market  
 \* - produkt nieprzeznaczony na rynek europejski

**YATO**

YT-7405\*



12

- GB** Pouch belt  
**D** Gürtel für Werkzeugtaschen  
**PL** Pas na kieszenie na narzędzia  
**RUS** Пояс для карманов для инструмента  
**CZ** Opasek na montéřské kapsáře  
**H** Öv erszényhez  
**RO** Cureau cu buzunare  
**E** Cinturón para bolsas de herramientas



HEADER  
CARD



**90-120**  
cm

HEAVY  
DUTY  
NYLON

**YATO**

YT-7409



50/100

- GB** 8-pocket tool bag  
**D** Gürtelwerkzeugtasche mit 8 Fächern  
**PL** 8. kieszeniowa torba na narzędzia  
**RUS** Сумка - 8 карманов для инструмента  
**CZ** Kapsář na nářadí 8-kapsový  
**H** Szerszámtartó erszény, 8 zsebbel  
**RO** Geanta pt. scule 8 buzunare  
**E** Bolso para herramientas de 8 bolsillos

HEADER  
CARD



**8**  
POCKETS  
KIESZENI

HEAVY  
DUTY  
NYLON



- GB** Universal cordless drill holder  
**D** Gürteltasche für Akkuschauber  
**PL** Kieszeń na wiertarkę akumulatorową  
**RUS** Карман для аккумуляторной дрели  
**CZ** Kapsář za opasek na akuvrtáčku  
**H** Univerzális tartóerszény akkus csavabehajtóhoz
- RO** Suport universal pt. bormasina  
**E** Bolsa porta taladradora de acumulador

HEADER  
CARD



HEAVY  
DUTY  
NYLON



**YATO**

YT-7410



20/40

**YATO**

YT-7413



20/40

**YATO**

YT-7414



48/96

- GB** Nail / tool pouch  
**D** Gürtelwerkzeugtasche  
**PL** Kieszeń na gwoździe i narzędzia  
**RUS** Карман для гвоздей и инструментов  
**CZ** Kapsář na nářadí  
**H** Szeg és szerszámtartó erszény  
**RO** Buzunar pt. scule / cuie  
**E** Bolsa porta herramientas y accesorios varios



**YATO**

YT-7416



20/40



**YATO**

YT-7417



39/156

HEADER  
CARD



HEAVY  
DUTY  
NYLON



- GB Nail pocket + hammer loop  
D Hammer und Nägel-Gürteltasche  
PL Kieszeń z uchwytem na młotek  
RUS Карман-держатель для молотка  
CZ Kapsář za opasek na kladivo  
H Szeg tartó erszény kalapáccstartóval  
RO Suport pt. ciocan  
E Bolsa con el soporte para martillo



HEAVY DUTY NYLON



**YATO**  
YT-7419 40/80

- GB Mobile phone pouch  
D Handy-Gürteltasche  
PL Kieszeń na telefon komórkowy  
RUS Карман для мобильного телефона  
CZ Pouzdro za opasek na mobilní telefon  
H Mobil telefon tartó  
RO Suport pt. telefon  
E Bolsa de teléfono móvil



HEAVY DUTY NYLON



**YATO**  
YT-7420 27/54

- GB Tool bag  
D Werkzeugtasche  
PL Torba na narzędzia  
RUS Сумка для инструмента  
CZ Taška montérská  
H Szerszámás táská  
RO Geanta pt. scule  
E Bolso de herramientas

HEAVY DUTY NYLON



**YATO**  
YT-7430 12



16 POCKETS KIESZENI

**YATO**  
YT-7433 12

- GB Trolley tool bag  
D Trolley-Werkzeugtasche  
PL Torba narzędziowa na kółkach  
RUS Сумка для инструмента на колесах  
CZ Taška na nářadí na kolečkách  
H Szerszámtartó táská kerekes  
RO Geanta pt. scule  
E Bolso de herramientas en ruedas

29 POCKETS

HEAVY DUTY NYLON

\* - product not for european market  
\* - produkt nieprzeznaczony na rynek europejski



**YATO**  
YT-7434\* 6

- GB Steel tube tool carrier  
D Werkzeugkoffer  
PL Walizka narzędziowa  
RUS Семодан для инструмента  
CZ Taška na nářadí  
H Szerszámtartó csővázás  
RO Geanta de otel pt. portbagaj  
E Maletin de herramientas

31 POCKETS KIESZENI

HEAVY DUTY NYLON



**YATO**  
YT-7435 4

- GB Foldable chair with bag  
D Werkzeugtasche mit Klappstuhl  
PL Torba narzędziowa z krzeselkiem  
RUS Стул складной с сумкой для инструмента  
CZ Taška na nářadí se stojánkem  
H Összecsukható szék tartózsébbel  
RO Scaun rabatabil cu geanta  
E Bolso de herramientas con silla plegable

22 POCKETS KIESZENI

HEAVY DUTY NYLON



**YATO**  
YT-7446 10

- GB Tool backpack  
D Werkzeugrucksack  
PL Plecak narzędziowy  
RUS Рюкзак для инструмента  
CZ Taška na nářadí  
H Szerszámtartó hátizsák  
RO Geanta pt. scule  
E Mochila de herramientas

28 POCKETS

HEAVY DUTY NYLON



\* - product not for european market  
\* - produkt nieprzeznaczony na rynek europejski

**YATO**  
YT-7440\* 12

# 20

**Health & safety articles**  
**Artykuły BHP**



Safety glasses  
Okulary ochronne

350



Hearing protectors  
Nauszniki przeciwhałasowe

354



Safety goggles  
Gogle ochronne

350



Working shoes  
Buty robocze

355-356



Working gloves  
Rękawice robocze

351-352



Low-cut safety shoes

Półbuty robocze..... 355

Middle-cut safety shoes

Trzewiki robocze..... 355

Knee pads  
Nakolanniki

352



Working clothes  
Odzież robocza

357



Disposable dust masks  
Półmaski filtrujące

353



Working jackets

Bluzy robocze..... 357

Working trousers

Spodnie robocze..... 357

Working overalls

Spodnie robocze ogrodniczki..... 357

Ear plugs  
Zatyczki do uszu

354

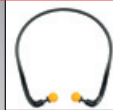

GB Safety glasses  
D Schutzbrille

PL Okulary ochronne  
RUS Очки защитные открытые

CZ Ochranné brýle  
H Védőszemüveg

RO Ochelari pt. protectie  
E Gafas protectoras

PAPER HANGING CARD



TYPE 90960 EN 166:2001 F

|             |        |
|-------------|--------|
| <b>YATO</b> |        |
| YT-7360     | 12/240 |



TYPE 9844 EN 166:2001 F

|             |        |
|-------------|--------|
| <b>YATO</b> |        |
| YT-7361     | 12/240 |



TYPE 91977 EN 166:2001 F

|             |        |
|-------------|--------|
| <b>YATO</b> |        |
| YT-7363     | 12/240 |



TYPE 91659 EN 166:2001 F

|             |        |
|-------------|--------|
| <b>YATO</b> |        |
| YT-7365     | 12/240 |



TYPE 91708 EN 166:2001 F

|             |        |
|-------------|--------|
| <b>YATO</b> |        |
| YT-7367     | 12/240 |



TYPE 91797 EN 166:2001 F

|             |        |
|-------------|--------|
| <b>YATO</b> |        |
| YT-7369     | 12/240 |



TYPE 91692 EN 166:2001 F

|             |        |
|-------------|--------|
| <b>YATO</b> |        |
| YT-7371     | 12/240 |



TYPE B524 EN 166:2001 F

|             |        |
|-------------|--------|
| <b>YATO</b> |        |
| YT-73631    | 12/300 |



TYPE B532 EN 166:2001 F

|             |        |
|-------------|--------|
| <b>YATO</b> |        |
| YT-73761    | 12/300 |



TYPE 9844 EN 166:2001 F

|             |        |
|-------------|--------|
| <b>YATO</b> |        |
| YT-7362     | 12/240 |



TYPE 91977 EN 166:2001 F

|             |        |
|-------------|--------|
| <b>YATO</b> |        |
| YT-7364     | 12/240 |



TYPE 91659 EN 166:2001 F

|             |        |
|-------------|--------|
| <b>YATO</b> |        |
| YT-7366     | 12/240 |



TYPE 91708 EN 166:2001 F

|             |        |
|-------------|--------|
| <b>YATO</b> |        |
| YT-7368     | 12/240 |



TYPE 91293 EN 166:2001 F

|             |        |
|-------------|--------|
| <b>YATO</b> |        |
| YT-7374     | 12/240 |



TYPE 91380 EN 166:2001 F

|             |        |
|-------------|--------|
| <b>YATO</b> |        |
| YT-7376     | 12/240 |



TYPE B517 EN 166:2001 F

|             |        |
|-------------|--------|
| <b>YATO</b> |        |
| YT-73641    | 12/300 |



TYPE B510 EN 166:2001 EN 169:2002

|             |        |
|-------------|--------|
| <b>YATO</b> |        |
| YT-73744    | 12/300 |



TYPE B532 EN 166:2001 F

|             |        |
|-------------|--------|
| <b>YATO</b> |        |
| YT-73760    | 12/300 |

GB Safety goggles  
D Schutzbrille  
PL Gogle ochronne

RUS Очки защитные  
CZ Ochranné brýle  
H Védőszemüveg

RO Ochelari pt. protectie  
E Gafas protectoras

PAPER  
HANGING  
CARD



TYPE 2876 EN 166:2001 F

|   |   |
|---|---|
| <b>YATO</b>  |  |
| YT-7377   | 12/120  |



TYPE #2769 EN 166:2001 F

|   |   |
|---|---|
| <b>YATO</b>  |  |
| YT-7380   | 20/200  |





TYPE SG90B EN 166:2001 F

|   |   |
|---|---|
| <b>YATO</b>  |  |
| YT-7381   | 20/200  |



TYPE SG-60 EN 166:2001 B

|  |   |
|--|---|
| <b>YATO</b>  |  |
| YT-7382  | 10/100  |



TYPE TW2015 EN 166:2001 B

|   |   |
|---|---|
| <b>YATO</b>  |  |
| YT-7383   | 10/100  |



TYPE B608 EN 166:2001 B

|   |   |
|---|---|
| <b>YATO</b>  |  |
| YT-73801  | 10/100  |





TYPE B421 EN 166:2001 B

|  |   |
|--|---|
| <b>YATO</b>  |  |
| YT-73830   | 10/100  |



GB Working gloves  
D Arbeitshandschuh  
PL Rękawice robocze  
RUS Рабочие перчатки  
CZ Pracovní rukavice  
H Védőkesztyű  
RO Mănuși de lucru  
E Guantes de piel

PAPER HEADER





|  |                |   |
|--|----------------|---|
| <b>YATO</b>  | size / rozmiar |  |
| YT-7470  | 10             | 50/100  |





|   |                |   |
|---|----------------|---|
| <b>YATO</b>  | size / rozmiar |  |
| YT-7472   | 10             | 50/100  |



|  |                |   |
|--|----------------|---|
| <b>YATO</b>  | size / rozmiar |  |
| YT-7473  | 10             | 50/100  |



|   |                |   |
|---|----------------|---|
| <b>YATO</b>  | size / rozmiar |  |
| YT-7474   | 10             | 50/100  |

GB Working gloves  
 D Arbeitshandschuh  
 PL Rękawice robocze  
 RUS Рабочие перчатки  
 CZ Pracovní rukavice  
 H Védőkesztyű  
 RO Mănuși de lucru  
 E Guantes de piel



| YATO    | size / rozmiar |        |
|---------|----------------|--------|
| YT-7480 | 9              | 12/120 |
| YT-7481 | 10             | 12/120 |

| YATO    | size / rozmiar |        |
|---------|----------------|--------|
| YT-7471 | 10             | 12/120 |



| YATO    | size / rozmiar |        |
|---------|----------------|--------|
| YT-7476 | 10             | 12/300 |

| YATO    | size / rozmiar |        |
|---------|----------------|--------|
| YT-7477 | 10             | 12/120 |

GB Working gloves  
 D Arbeitshandschuh  
 PL Rękawice robocze

RUS Рабочие перчатки  
 CZ Pracovní rukavice  
 H Védőkesztyű

RO Mănuși de lucru  
 E Guantes de piel



| YATO    | size / rozmiar |       |
|---------|----------------|-------|
| YT-7464 | 7 / L          | 12/48 |
| YT-7465 | 9 / XXL        | 12/48 |

| YATO    | size / rozmiar |       |
|---------|----------------|-------|
| YT-7466 | 7 / L          | 12/72 |
| YT-7467 | 9 / XXL        | 12/72 |

| YATO    | size / rozmiar |       |
|---------|----------------|-------|
| YT-7468 | 7 / L          | 12/48 |
| YT-7469 | 9 / XXL        | 12/48 |

GB Gel knee pads  
 D Gel Knieschoner  
 PL Nakolanniki żelowe  
 RUS Гелевые наколенники  
 CZ Nákoleníky gelové

H Térdvédő zselés  
 RO Genunchiere cu protectie de silicon  
 E Protectores de gel para rodillas



DISPLAY COLOR BOX



| YATO    |    |  |
|---------|----|--|
| YT-7460 | 12 |  |

| YATO    |    |  |
|---------|----|--|
| YT-7461 | 12 |  |



GB Disposable dust masks  
D Atemschutzmaske  
PL Półmiski filtrujące jednorazowe  
RUS Респиратор противопылевой одноразовый  
CZ Protiprašná maska  
H Eldobható porvédőmaszk  
RO Masca praaf  
E Mascarilla desechable para protección contra polvo



POLYBAG WITH HEADER  
**YATO**  
YT-7485 25/100

GB Disposable dust masks with valve  
D Atemschutzmaske mit Ventil  
PL Półmiski filtrujące jednorazowe z zaworem  
RUS Респиратор противопылевой одноразовый с клапаном  
CZ Protiprašná maska s ventilem  
H Eldobható porvédőmaszk, szelepes  
RO Masca praaf cu valva  
E Mascarilla desechable para protección contra polvo

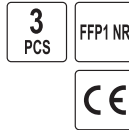

POLYBAG WITH HEADER  
**YATO**  
YT-7486 25/100

GB Disposable dust masks  
D Atemschutzmaske  
PL Półmiski filtrujące jednorazowe  
RUS Респиратор противопылевой одноразовый  
CZ Protiprašná maska  
H Eldobható porvédőmaszk  
RO Masca praaf  
E Mascarilla desechable para protección contra polvo



POLYBAG WITH HEADER  
**YATO**  
YT-7487 25/100

GB Disposable dust masks with valve  
D Atemschutzmaske mit Ventil  
PL Półmiski filtrujące jednorazowe z zaworem  
RUS Респиратор противопылевой одноразовый с клапаном  
CZ Protiprašná maska s ventilem  
H Eldobható porvédőmaszk, szelepes  
RO Masca praaf cu valva  
E Mascarilla desechable para protección contra polvo



POLYBAG WITH HEADER  
**YATO**  
YT-7488 25/100

GB Disposable dust masks  
D Atemschutzmaske  
PL Półmiski filtrujące jednorazowe  
RUS Респиратор противопылевой одноразовый  
CZ Protiprašná maska  
H Eldobható porvédőmaszk  
RO Masca praaf  
E Mascarilla desechable para protección contra polvo

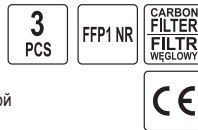

POLYBAG WITH HEADER  
**YATO**  
YT-7489 25/100

GB Disposable dust masks with valve  
D Atemschutzmaske mit Ventil  
PL Półmiski filtrujące jednorazowe z zaworem  
RUS Респиратор противопылевой одноразовый с клапаном  
CZ Protiprašná maska s ventilem  
H Eldobható porvédőmaszk, szelepes  
RO Masca praaf cu valva  
E Mascarilla desechable para protección contra polvo



POLYBAG WITH HEADER  
**YATO**  
YT-7490 25/100

GB Disposable dust masks  
D Atemschutzmaske  
PL Półmiski filtrujące jednorazowe  
RUS Респиратор противопылевой одноразовый  
CZ Protiprašná maska  
H Eldobható porvédőmaszk  
RO Masca praaf  
E Mascarilla desechable para protección contra polvo



POLYBAG WITH HEADER  
**YATO**  
YT-7491 25/100

GB Disposable dust masks with valve  
D Atemschutzmaske mit Ventil  
PL Półmiski filtrujące jednorazowe z zaworem  
RUS Респиратор противопылевой одноразовый с клапаном  
CZ Protiprašná maska s ventilem  
H Eldobható porvédőmaszk, szelepes  
RO Masca praaf cu valva  
E Mascarilla desechable para protección contra polvo



POLYBAG WITH HEADER  
**YATO**  
YT-7492 15/60

GB Disposable dust masks  
D Atemschutzmaske  
PL Półmiski filtrujące jednorazowe  
RUS Респиратор противопылевой одноразовый  
CZ Protiprašná maska  
H Eldobható porvédőmaszk  
RO Masca praaf  
E Mascarilla desechable para protección contra polvo



POLYBAG WITH HEADER  
**YATO**  
YT-7493 25/100

GB Disposable dust masks with valve  
D Atemschutzmaske mit Ventil  
PL Półmiski filtrujące jednorazowe z zaworem  
RUS Респиратор противопылевой одноразовый с клапаном  
CZ Protiprašná maska s ventilem  
H Eldobható porvédőmaszk, szelepes  
RO Masca praaf cu valva  
E Mascarilla desechable para protección contra polvo



POLYBAG WITH HEADER  
**YATO**  
YT-7494 15/60

GB Ear plugs  
D Gehörschutz  
PL Zatycki do uszu

RUS Средства защиты слуха  
CZ Chráněče sluchu  
H Fülvédőt

RO Antifoane  
E Protectores de la vista



100 PCS



SNR 33 dB

| YATO    | size / rozmiar (mm) | pairs / pary | box |
|---------|---------------------|--------------|-----|
| YT-7450 | 7-12                | 100          | 20  |



POLYBAG WITH HEADER

SNR 34 dB

| YATO    | size / rozmiar (mm) | pairs / pary | box    |
|---------|---------------------|--------------|--------|
| YT-7451 | 7-12                | 5            | 25/500 |



200 PCS



SNR 34 dB

| YATO     | size / rozmiar (mm) | pairs / pary | box |
|----------|---------------------|--------------|-----|
| YT-74510 | 7-12                | 200          | 20  |

GB Ear plugs  
D Gehörschutz  
PL Zatycki do uszu

RUS Средства защиты слуха  
CZ Chráněče sluchu  
H Fülvédőt

RO Antifoane  
E Protectores de la vista



100 PCS



SNR 28 dB

| YATO    | size / rozmiar (mm) | pairs / pary | box |
|---------|---------------------|--------------|-----|
| YT-7452 | 8-13                | 100          | 20  |

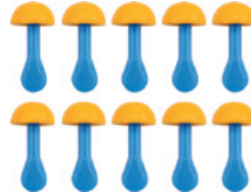

POLYBAG WITH HEADER

SNR 28 dB

| YATO    | size / rozmiar (mm) | pairs / pary | box    |
|---------|---------------------|--------------|--------|
| YT-7453 | 8-13                | 5            | 25/500 |



50 PCS



SNR 22 dB

| YATO    | size / rozmiar (mm) | pairs / pary | box |
|---------|---------------------|--------------|-----|
| YT-7454 | 8-12                | 50           | 20  |



POLYBAG WITH HEADER

SNR 22 dB

| YATO    | size / rozmiar (mm) | pairs / pary | box    |
|---------|---------------------|--------------|--------|
| YT-7455 | 8-12                | 5            | 25/500 |

GB Ear plugs  
D Gehörschutz  
PL Zatycki do uszu na sznurku

RUS Средства защиты слуха  
CZ Chráněče sluchu  
H Fülvédőt

RO Antifoane  
E Protectores de la vista

SNR 28 dB



50 PCS



| YATO    | size / rozmiar (mm) | pairs / pary | box |
|---------|---------------------|--------------|-----|
| YT-7456 | 8-10                | 50           | 20  |

GB Ear plugs  
D Gehörschutz  
PL Zatycki do uszu na paląku  
RUS Средства защиты слуха  
CZ Chráněče sluchu  
H Fülvédőt  
RO Antifoane  
E Protectores de la vista



SNR 21 dB

| YATO    | box    |
|---------|--------|
| YT-7458 | 25/500 |



SNR 26 dB

| YATO    | box    |
|---------|--------|
| YT-7459 | 25/500 |

GB Hearing protectors  
D Gehörschutz

PL Nauszniki przeciwhałasowe  
RUS Средства защиты слуха

CZ Chráněče sluchu  
H Fülvédőt

RO Antifoane  
E Protectores de la vista



SNR 26 dB

| YATO    | box |
|---------|-----|
| YT-7462 | 40  |



SNR 26 dB

| YATO    | box |
|---------|-----|
| YT-7463 | 20  |



SNR 27 dB

| YATO     | box |
|----------|-----|
| YT-74621 | 60  |

GB Low - cut safety shoes CZ Pracovní polobotky  
D Arbeitshaltschuhe H Munkavédelmi félcipő  
PL Półbuty robocze RO Papuc de lucru  
RUS Полуботинки рабочие E Zapato de trabajo

CARTON BOX  
WITH COLOR  
LABEL



### PIURA

INSOLE & MESH COATED EVA  
WKLADKA I WYŚCIOŁKA Z MATERIAŁU EVA

STEEL TOE CAP  
STALOWY NOSEK

PU SOLE  
PODESZWA Z POLIURETANU

SHOCK ABSORBER  
AMORTYZATOR DRGAŃ

SRA CATEGORY KATEGORIA

S3 CATEGORY KATEGORIA

### PUEBLE

INSOLE & MESH COATED EVA  
WKLADKA I WYŚCIOŁKA Z MATERIAŁU EVA

STEEL TOE CAP  
STALOWY NOSEK

PU SOLE  
PODESZWA Z POLIURETANU

SHOCK ABSORBER  
AMORTYZATOR DRGAŃ

SRA CATEGORY KATEGORIA

S3 CATEGORY KATEGORIA

| YATO     | size / rozmiar |    |
|----------|----------------|----|
| YT-80552 | 39             | 10 |
| YT-80553 | 40             | 10 |
| YT-80554 | 41             | 10 |
| YT-80555 | 42             | 10 |
| YT-80556 | 43             | 10 |
| YT-80557 | 44             | 10 |
| YT-80558 | 45             | 10 |
| YT-80559 | 46             | 10 |
| YT-80560 | 47             | 10 |

| YATO     | size / rozmiar |    |
|----------|----------------|----|
| YT-80583 | 39             | 10 |
| YT-80584 | 40             | 10 |
| YT-80585 | 41             | 10 |
| YT-80586 | 42             | 10 |
| YT-80587 | 43             | 10 |
| YT-80588 | 44             | 10 |
| YT-80589 | 45             | 10 |
| YT-80590 | 46             | 10 |
| YT-80591 | 47             | 10 |

### PARENA

INSOLE & MESH COATED EVA  
WKLADKA I WYŚCIOŁKA Z MATERIAŁU EVA

STEEL TOE CAP  
STALOWY NOSEK

PU SOLE  
PODESZWA Z POLIURETANU

SHOCK ABSORBER  
AMORTYZATOR DRGAŃ

SRA CATEGORY KATEGORIA

S1P CATEGORY KATEGORIA

### PUNO

INSOLE & MESH COATED EVA  
WKLADKA I WYŚCIOŁKA Z MATERIAŁU EVA

STEEL TOE CAP  
STALOWY NOSEK

PU SOLE  
PODESZWA Z POLIURETANU

SHOCK ABSORBER  
AMORTYZATOR DRGAŃ

SRC CATEGORY KATEGORIA

S3 CATEGORY KATEGORIA

| YATO     | size / rozmiar |    |
|----------|----------------|----|
| YT-80572 | 39             | 10 |
| YT-80573 | 40             | 10 |
| YT-80574 | 41             | 10 |
| YT-80575 | 42             | 10 |
| YT-80576 | 43             | 10 |
| YT-80577 | 44             | 10 |
| YT-80578 | 45             | 10 |
| YT-80579 | 46             | 10 |
| YT-80580 | 47             | 10 |

| YATO     | size / rozmiar |    |
|----------|----------------|----|
| YT-80541 | 39             | 10 |
| YT-80542 | 40             | 10 |
| YT-80543 | 41             | 10 |
| YT-80544 | 42             | 10 |
| YT-80545 | 43             | 10 |
| YT-80546 | 44             | 10 |
| YT-80547 | 45             | 10 |
| YT-80548 | 46             | 10 |
| YT-80549 | 47             | 10 |

GB Middle - cut safety shoes RUS Ботинки рабочие RO Pantof de lucru  
D Arbeitsschnürschuה CZ Pracovní boty šněrovací E Calzado de trabajo  
PL Trzewiki robocze H Munkavédelmi bakancs

CARTON BOX  
WITH COLOR  
LABEL

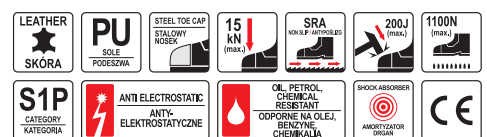

### TABAR

INSOLE & MESH COATED EVA  
WKLADKA I WYŚCIOŁKA Z MATERIAŁU EVA

STEEL TOE CAP  
STALOWY NOSEK

PU SOLE  
PODESZWA Z POLIURETANU

SHOCK ABSORBER  
AMORTYZATOR DRGAŃ

| YATO     | size / rozmiar |    |
|----------|----------------|----|
| YT-80761 | 39             | 10 |
| YT-80762 | 40             | 10 |
| YT-80763 | 41             | 10 |
| YT-80764 | 42             | 10 |
| YT-80765 | 43             | 10 |
| YT-80766 | 44             | 10 |
| YT-80767 | 45             | 10 |
| YT-80768 | 46             | 10 |
| YT-80769 | 47             | 10 |

GB Middle - cut safety shoes  
D Arbeitsschnürschuhe  
PL Trzewiki robocze

RUS Ботинки рабочие  
CZ Pracovní boty šněrovací  
H Munkavédelmi bakancs

RO Pantof de lucru  
E Calzado de trabajo

CARTON BOX WITH COLOR LABEL

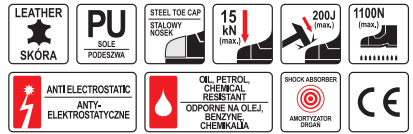

INSOLE & MESH COATED EVA  
WKŁADKA I WYŚCIÓŁKA Z MATERIAŁU EVA



SHOCK ABSORBER  
AMORTYZATOR DRGAŃ



**TOLU**

STEEL TOE CAP  
STALOWY NOSEK

PU SOLE  
PODESZWA Z POLIURETANU



INSOLE & MESH COATED EVA  
WKŁADKA I WYŚCIÓŁKA Z MATERIAŁU EVA



SHOCK ABSORBER  
AMORTYZATOR DRGAŃ



**TRAT**

STEEL TOE CAP  
STALOWY NOSEK

PU SOLE  
PODESZWA Z POLIURETANU



| YATO     | size / rozmiar |    |
|----------|----------------|----|
| YT-80794 | 39             | 10 |
| YT-80795 | 40             | 10 |
| YT-80796 | 41             | 10 |
| YT-80797 | 42             | 10 |
| YT-80798 | 43             | 10 |
| YT-80799 | 44             | 10 |
| YT-80800 | 45             | 10 |
| YT-80801 | 46             | 10 |
| YT-80802 | 47             | 10 |

| YATO     | size / rozmiar |    |
|----------|----------------|----|
| YT-80772 | 39             | 10 |
| YT-80773 | 40             | 10 |
| YT-80774 | 41             | 10 |
| YT-80775 | 42             | 10 |
| YT-80776 | 43             | 10 |
| YT-80777 | 44             | 10 |
| YT-80778 | 45             | 10 |
| YT-80779 | 46             | 10 |
| YT-80780 | 47             | 10 |

INSOLE & MESH COATED EVA  
WKŁADKA I WYŚCIÓŁKA Z MATERIAŁU EVA



SHOCK ABSORBER  
AMORTYZATOR DRGAŃ



**TWER**

STEEL TOE CAP  
STALOWY NOSEK

PU SOLE  
PODESZWA Z POLIURETANU



INSOLE & MESH COATED EVA  
WKŁADKA I WYŚCIÓŁKA Z MATERIAŁU EVA



SHOCK ABSORBER  
AMORTYZATOR DRGAŃ



**ALBIT**

STEEL TOE CAP  
STALOWY NOSEK

PU SOLE  
PODESZWA Z POLIURETANU



| YATO     | size / rozmiar |    |
|----------|----------------|----|
| YT-80783 | 39             | 10 |
| YT-80784 | 40             | 10 |
| YT-80785 | 41             | 10 |
| YT-80786 | 42             | 10 |
| YT-80787 | 43             | 10 |
| YT-80788 | 44             | 10 |
| YT-80789 | 45             | 10 |
| YT-80790 | 46             | 10 |
| YT-80791 | 47             | 10 |

| YATO     | size / rozmiar |    |
|----------|----------------|----|
| YT-80811 | 39             | 10 |
| YT-80812 | 40             | 10 |
| YT-80813 | 41             | 10 |
| YT-80814 | 42             | 10 |
| YT-80815 | 43             | 10 |
| YT-80816 | 44             | 10 |
| YT-80817 | 45             | 10 |
| YT-80818 | 46             | 10 |
| YT-80819 | 47             | 10 |

INSOLE & MESH COATED EVA  
WKŁADKA I WYŚCIÓŁKA Z MATERIAŁU EVA



SHOCK ABSORBER  
AMORTYZATOR DRGAŃ



**ATAR**

STEEL TOE CAP  
STALOWY NOSEK

PU SOLE  
PODESZWA Z POLIURETANU



INSOLE & MESH COATED EVA  
WKŁADKA I WYŚCIÓŁKA Z MATERIAŁU EVA



SHOCK ABSORBER  
AMORTYZATOR DRGAŃ



**TEZU**

STEEL TOE CAP  
STALOWY NOSEK

PU SOLE  
PODESZWA Z POLIURETANU



| YATO     | size / rozmiar |    |
|----------|----------------|----|
| YT-80823 | 39             | 10 |
| YT-80824 | 40             | 10 |
| YT-80825 | 41             | 10 |
| YT-80826 | 42             | 10 |
| YT-80827 | 43             | 10 |
| YT-80828 | 44             | 10 |
| YT-80829 | 45             | 10 |
| YT-80830 | 46             | 10 |
| YT-80831 | 47             | 10 |

| YATO     | size / rozmiar |    |
|----------|----------------|----|
| YT-80841 | 39             | 10 |
| YT-80842 | 40             | 10 |
| YT-80843 | 41             | 10 |
| YT-80844 | 42             | 10 |
| YT-80845 | 43             | 10 |
| YT-80846 | 44             | 10 |
| YT-80847 | 45             | 10 |
| YT-80848 | 46             | 10 |
| YT-80849 | 47             | 10 |



GB Working jacket  
D Arbeitsjacke  
PL Bluzą roboczą  
RUS Рабочая рубашка  
CZ Pracovní blůza

H Munkaruha felső  
RO Bluză de lucru  
E Blusa de trabajo



POLYBAG





| YATO  | size / rozmiar |  |
|--|----------------|---|
| YT-8020  | S              | 20  |
| YT-8021  | M              | 20  |
| YT-8022  | L              | 20  |
| YT-8023  | XL             | 20  |
| YT-8024  | XXL            | 20  |

GB Working trousers  
D Arbeitshosen  
PL Spodnie robocze  
RUS Рабочие брюки  
CZ Pracovní kalhoty  
H Munkaruha nadrág  
RO Pantaloni de lucru  
E Pantalón de trabajo



POLYBAG





| YATO  | size / rozmiar |  |
|--|----------------|---|
| YT-8025  | S              | 20  |
| YT-8026  | M              | 20  |
| YT-8027  | L              | 20  |
| YT-8028  | XL             | 20  |
| YT-8029  | XXL            | 20  |

GB Working overalls  
D Arbeitshosen, Gärtnerin  
PL Spodnie robocze ogrodniczki  
RUS Рабочий полукombineзон  
CZ Pracovní kalhoty lačlové  
H Kertész nadrág  
RO Pantaloni de lucru grădină  
E Pantalón de trabajo tipo jardinero



POLYBAG



| YATO  | size / rozmiar |  |
|--|----------------|---|
| YT-8030  | S              | 20  |
| YT-8031  | M              | 20  |
| YT-8032  | L              | 20  |
| YT-8033  | XL             | 20  |
| YT-8034  | XXL            | 20  |

# 21

## Electric products Artykuły elektryczne



Extension cords  
Przedłużacze elektryczne

360



Diode workshop lamps  
Diodowe lampy warsztatowe

361-363



GB Extension cord  
 D Verlängerungskabel  
 PL Przedłużacz elektryczny  
 RUS Удлинитель электрический  
 CZ Elektrický prodloužovač  
 H Elektromos hosszabbító  
 RO Prelungitor electric  
 E Extensión electr.

COLOR BOX



16 A  
~250V

CABLE  
H05RRN-F  
KABEL

IP44

3G2.5 mm<sup>2</sup>  
CABLE / KABEL

E  
TYPE / TYP

E & F  
TYPE / TYP

CE



| YATO    | L (m) |   |
|---------|-------|---|
| YT-8100 | 20    | 4 |
| YT-8101 | 30    | 2 |
| YT-8102 | 40    | 2 |

GB Rubber protection extension cord  
 D Gummiisolierte Verlängerungsschnur  
 PL Przedłużacz w osłonie gumowej  
 RUS Удлинитель с резиновой изоляцией  
 CZ Prodloužovací kabel s gumovou izolací  
 H Gumi szigetelésű hosszabbító  
 RO Cablu prelungitor cauciuc  
 E Cable de extensión con protección de caucho

230V~  
50Hz

16A

CABLE  
H07RN-F  
KABEL

3G1.5 mm<sup>2</sup>  
CABLE / KABEL

E  
TYPE / TYP

E & F  
TYPE / TYP

IP44

CE



| YATO    | L (m) |    |
|---------|-------|----|
| YT-8110 | 2     | 40 |
| YT-8111 | 5     | 16 |
| YT-8112 | 10    | 8  |

GB Rubber protection extension cord  
 D Gummiisolierte Verlängerungsschnur  
 PL Przedłużacz w osłonie gumowej  
 RUS Удлинитель с резиновой изоляцией  
 CZ Prodloužovací kabel s gumovou izolací  
 H Gumi szigetelésű hosszabbító  
 RO Cablu prelungitor cauciuc  
 E Cable de extensión con protección de caucho

230V~  
50Hz

16A

CABLE  
H07RN-F  
KABEL

3G1.5 mm<sup>2</sup>  
CABLE / KABEL

E  
TYPE / TYP

E & F  
TYPE / TYP

IP44

CE



| YATO    | L (m) |    |
|---------|-------|----|
| YT-8115 | 2     | 10 |
| YT-8116 | 10    | 4  |

GB Cable reel  
 D Kabeltrommel  
 PL Przedłużacz zwijany  
 RUS Удлинитель электрический  
 CZ Bubnový prodloužovač  
 H Kábeldob  
 RO Prelungitor pe tambur  
 E Cable de prolongación de tambor

16 A  
~250V

CABLE  
H07RN-F  
KABEL

IP44

E  
TYPE / TYP

E & F  
TYPE / TYP

3G2.5 mm<sup>2</sup>  
CABLE / KABEL

METAL REEL  
BEBEN  
STALOWY

CE



$P_{max} = 1300 W$  coiled  
 $P_{max} = 1300 W$  zwinęty

$P_{max} = 3600 W$  uncoiled  
 $P_{max} = 3600 W$  rozwinęty

| YATO    | L (m) |   |
|---------|-------|---|
| YT-8104 | 40    | 1 |

GB Cable reel  
 D Kabeltrommel  
 PL Przedłużacz zwijany  
 RUS Удлинитель электрический  
 CZ Bubnový prodloužovač  
 H Kábeldob  
 RO Prelungitor pe tambur  
 E Cable de prolongación de tambor

16 A  
~230V

CABLE  
H07RN-F  
KABEL

IP44

E  
TYPE / TYP

E & F  
TYPE / TYP

3G2.5 mm<sup>2</sup>  
CABLE / KABEL

PLASTIC REEL  
BEBEN  
PLASTIKOWY

CE



$P_{max} = 1200 W$  coiled  
 $P_{max} = 1200 W$  zwinęty

$P_{max} = 3600 W$  uncoiled  
 $P_{max} = 3600 W$  rozwinęty

| YATO    | L (m) |   |
|---------|-------|---|
| YT-8106 | 30    | 1 |
| YT-8107 | 40    | 1 |
| YT-8108 | 50    | 1 |

GB Drum power extension cord  
 D Verlängerungstrommel für Kraftstrom  
 PL Przedłużacz bębnowy siłowy  
 RUS Силовой удлинитель барабанного типа  
 CZ Prodloužovací kabel silový na bubnu  
 H Háromfázisú hosszabbító dob  
 RO Derulator cu tambur  
 E Cilindro de extensión de fuerza

~400V  
~230V

CABLE  
H07RN-F  
KABEL

IP44

E  
TYPE / TYP

3P+N+E  
TYPE / TYP

5G2.5 mm<sup>2</sup>  
CABLE / KABEL

CE



~230V; 2P+E  
 $P_{max} = 1200 W$  coiled  
 $P_{max} = 1200 W$  zwinęty  
 $P_{max} = 3000 W$  uncoiled  
 $P_{max} = 3000 W$  rozwinęty

~400V; 3P+N+E  
 $P_{max} = 3000 W$  coiled  
 $P_{max} = 3000 W$  zwinęty  
 $P_{max} = 9000 W$  uncoiled  
 $P_{max} = 9000 W$  rozwinęty

| YATO    | L (m) |   |
|---------|-------|---|
| YT-8120 | 25    | 1 |



GB LED lamp  
D Diodenscheinwerfer  
PL Reflektor diodowy  
RUS Светодиодный прожектор  
CZ LED reflektor  
H Diódás reflektor  
RO Reflector diodă  
E Reflector de diodos



COLOR BOX



|                               |               |   |
|-------------------------------|---------------|---|
| ~220-240V<br>50Hz             | <b>6W</b>     | <b>6 LED</b>  |
| HIGH POWER LED                | <b>510 lm</b> |  30 000-50 000 h |
| <b>1W</b><br>DIODA DUŻEJ MOCY | <b>IP54</b>   | <b>CE</b>   |



LOW ENERGY CONSUMPTION  
  
NISKIE ZUŻYCIE ENERGII

|   |   |
|---|---|
| <b>YATO</b>  |  |
| YT-81780  | 24  |

GB LED lamp with motion detector  
D Diodenscheinwerfer mit Bewegungsmelder  
PL Reflektor diodowy z czujnikiem ruchu  
RUS Светодиодный прожектор с датчиком движения  
CZ LED reflektor se snímačem pohybu  
H Diódás reflektor mozgásérzékelővel  
RO Reflector diodă cu senzor de mișcare  
E Reflector de diodos con sensor de movimiento

COLOR BOX





|                               |               |   |
|-------------------------------|---------------|---|
| ~220-240V<br>50Hz             | <b>6W</b>     | <b>6 LED</b>  |
| HIGH POWER LED                | <b>510 lm</b> |  30 000-50 000 h |
| <b>1W</b><br>DIODA DUŻEJ MOCY | <b>IP44</b>   | <b>CE</b>   |



LOW ENERGY CONSUMPTION  
  
NISKIE ZUŻYCIE ENERGII

MOTION DETECTOR  
  
CZUJNIK RUCHU

|   |   |
|---|---|
| <b>YATO</b>  |  |
| YT-81791  | 18  |

GB Portable LED lamp  
D Diodenscheinwerfer, mit Tragebügel  
PL Reflektor diodowy przenośny  
RUS Светодиодный прожектор переносной  
CZ LED reflektor přenosný  
H Hordozható, diódás reflektor  
RO Reflector diodă portabil  
E Reflector de diodos portátil



COLOR BOX



|                               |               |   |
|-------------------------------|---------------|---|
| ~220-240V<br>50Hz             | <b>6W</b>     | <b>6 LED</b>  |
| HIGH POWER LED                | <b>510 lm</b> |  30 000-50 000 h |
| <b>1W</b><br>DIODA DUŻEJ MOCY | <b>IP54</b>   | <b>CE</b>   |



LOW ENERGY CONSUMPTION  
  
NISKIE ZUŻYCIE ENERGII

|   |   |
|---|---|
| <b>YATO</b>  |  |
| YT-81792  | 12  |

GB LED lamp  
D Diodenscheinwerfer  
PL Reflektor diodowy  
RUS Светодиодный прожектор  
CZ LED reflektor  
H Diódás reflektor  
RO Reflector diodă  
E Reflector de diodos



COLOR BOX



|                               |                |   |
|-------------------------------|----------------|---|
| ~220-240V<br>50Hz             | <b>12W</b>     | <b>12 LED</b>   |
| HIGH POWER LED                | <b>1020 lm</b> |  30 000-50 000 h |
| <b>1W</b><br>DIODA DUŻEJ MOCY | <b>IP54</b>    | <b>CE</b>   |



LOW ENERGY CONSUMPTION  
  
NISKIE ZUŻYCIE ENERGII

|   |   |
|---|---|
| <b>YATO</b>  |  |
| YT-81793  | 16  |

GB LED lamp with motion detector  
D Diodenscheinwerfer mit Bewegungsmelder  
PL Reflektor diodowy z czujnikiem ruchu  
RUS Светодиодный прожектор с датчиком движения  
CZ LED reflektor se snímačem pohybu  
H Hordozható, diódás reflektor  
RO Reflector diodă cu senzor de mișcare  
E Reflector de diodos con sensor de movimiento

COLOR BOX



|                               |                |   |
|-------------------------------|----------------|---|
| ~220-240V<br>50Hz             | <b>12W</b>     | <b>12 LED</b>   |
| HIGH POWER LED                | <b>1020 lm</b> |  30 000-50 000 h |
| <b>1W</b><br>DIODA DUŻEJ MOCY | <b>IP44</b>    | <b>CE</b>   |



LOW ENERGY CONSUMPTION  
  
NISKIE ZUŻYCIE ENERGII

MOTION DETECTOR  
  
CZUJNIK RUCHU

|   |   |
|---|---|
| <b>YATO</b>  |  |
| YT-81794  | 12  |

GB Portable LED lamp  
D Diodenscheinwerfer, mit Tragebügel  
PL Reflektor diodowy przenośny  
RUS Светодиодный прожектор переносной  
CZ LED reflektor přenosný  
H Hordozható, diódás reflektor  
RO Reflector diodă portabil  
E Reflector de diodos portátil

COLOR BOX



|                               |                |   |
|-------------------------------|----------------|---|
| ~220-240V<br>50Hz             | <b>12W</b>     | <b>12 LED</b>   |
| HIGH POWER LED                | <b>1020 lm</b> |  30 000-50 000 h |
| <b>1W</b><br>DIODA DUŻEJ MOCY | <b>IP54</b>    | <b>CE</b>   |



LOW ENERGY CONSUMPTION  
  
NISKIE ZUŻYCIE ENERGII

|   |   |
|---|---|
| <b>YATO</b>  |  |
| YT-81795  | 8   |

GB Rechargeable work lamp  
 D Led Werkstattlampe  
 PL Diodowa lampa bezprzewodowa  
 RUS Светодиодная беспроводная лампа  
 CZ Montážní lampa diodová bezpřívodová  
 H Ledlámpa  
 RO Lampa cu led fara cablu  
 E Lámpara inalámbrica de diodos

|  |                                    |
|--|------------------------------------|
| 230V~50Hz<br>BATTERY CHARGER LADOWARKA | <b>30 LED</b>                      |
| 4.8V<br>3300 mAh<br>NiMH               | 8-10 h                             |
| BATTERY CHARGER LADOWARKA              | SHOCK PROOF<br>ODPORNA NA WSTRZASY |
| OIL PROOF<br>ODPORNA NA OLEJ           | WATER PROOF<br>ODPORNA NA WODE     |
| <b>CE</b>                              |                                    |



GB Rechargeable work lamp  
 D Led Werkstattlampe  
 PL Diodowa lampa bezprzewodowa  
 RUS Светодиодная беспроводная лампа  
 CZ Montážní lampa diodová bezpřívodová  
 H Ledlámpa  
 RO Lampa cu led fara cablu  
 E Lámpara inalámbrica de diodos

|   |  |
|---|--|
| 21+5 LED  | 3 POSITION POZYCJE                                 |
| 3.6V<br>1800mAh<br>NiMH                               | 230V~50Hz<br>BATTERY CHARGER LADOWARKA             |
| 21 LED<br>4-5h  | 5 LED<br>10h                                       |
| WATER PROOF<br>ODPORNA NA WODE                        | OVERLOAD PROTECTION<br>ZABEZPECZENIE PRZEŁADOWANIA |
| SHOCK PROOF<br>ODPORNA NA WSTRZASY                    | OIL PROOF<br>ODPORNA NA OLEJ                       |
| SHORTAGE PROTECTION<br>ZABEZPECZENIE PRZECIWNADZIENIE | <b>CE</b>  |



**MAGNETIC**

**YATO**  
 YT-0851 20

GB Rechargeable work lamp  
 D Led Werkstattlampe  
 PL Diodowa lampa warsztatowa  
 RUS Светодиодная беспроводная лампа  
 CZ Montážní lampa diodová bezpřívodová  
 H Ledlámpa  
 RO Lampa cu led fara cablu  
 E Lámpara inalámbrica de diodos

|                                |  |
|--------------------------------|--|
| <b>27 LED</b>                  | <b>13000 MCD</b>                       |
| 3.6V<br>1200mAh<br>NiMH        | 230V~50Hz<br>BATTERY CHARGER LADOWARKA |
| 4 h                            | CHARGING TIME<br>CZAS LADOWANIA<br>4 h |
| WATER PROOF<br>ODPORNA NA WODE | MAGNETIC                               |
| <b>CE</b>                      |  |



**YATO**  
 YT-0852 10

GB Rechargeable work lamp  
D Led Werkstattlampe  
PL Diodowa lampa warsztatowa  
RUS Светодиодная беспроводная лампа  
CZ Montážní lampa diodová bezpřívodová  
H Ledlampa  
RO Lampa cu led fara cablu  
E Lámpara inalámbrica de diodos



COLOR BOX

**YATO**  
YT-08505 10

GB Rechargeable work lamp  
D Led Werkstattlampe  
PL Diodowa lampa warsztatowa  
RUS Светодиодная беспроводная лампа  
CZ Montážní lampa diodová bezpřívodová  
H Ledlampa  
RO Lampa cu led fara cablu  
E Lámpara inalámbrica de diodos

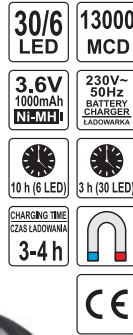

COLOR BOX

**YATO**  
YT-08512 12

GB Rechargeable work lamp  
D Led Werkstattlampe  
PL Diodowa lampa warsztatowa  
RUS Светодиодная беспроводная лампа  
CZ Montážní lampa diodová bezpřívodová  
H Ledlampa  
RO Lampa cu led fara cablu  
E Lámpara inalámbrica de diodos



DOUBLE BLISTER



**YATO**  
YT-0852 5/20

GB Under bonnet work led lamp  
D Led Werkstattlampe  
PL Diodowa lampa warsztatowa do oświetlenia komory silnika  
RUS Светодиодная беспроводная лампа  
CZ Montážní lampa diodová bezpřívodová  
H Ledlampa  
RO Lampa cu led fara cablu  
E Lámpara inalámbrica de diodos

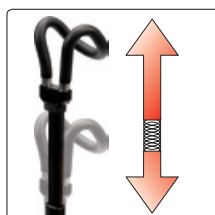
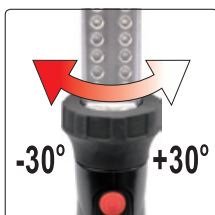
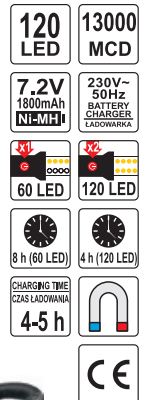

COLOR BOX

**YATO**  
YT-08530 4

**PRODUCT INDEX**



**INDEKS PRODUKTÓW**

| YATO     | page/strona |
|----------|-------------|
| YT-0006  | 7           |
| YT-0007  | 7           |
| YT-0008  | 7           |
| YT-0009  | 7           |
| YT-0010  | 7           |
| YT-0011  | 7           |
| YT-0012  | 7           |
| YT-0013  | 7           |
| YT-0014  | 7           |
| YT-0015  | 7           |
| YT-0016  | 7           |
| YT-0017  | 7           |
| YT-0018  | 7           |
| YT-0019  | 7           |
| YT-0020  | 7           |
| YT-0021  | 7           |
| YT-0022  | 7           |
| YT-0023  | 7           |
| YT-0024  | 7           |
| YT-0025  | 7           |
| YT-0026  | 7           |
| YT-0027  | 7           |
| YT-0028  | 7           |
| YT-0029  | 7           |
| YT-0030  | 7           |
| YT-0032  | 7           |
| YT-0036  | 7           |
| YT-0038  | 7           |
| YT-0041  | 7           |
| YT-0046  | 7           |
| YT-0050  | 7           |
| YT-0055  | 7           |
| YT-0060  | 7           |
| YT-0062  | 7           |
| YT-0065  | 7           |
| YT-0067  | 7           |
| YT-0075  | 7           |
| YT-00760 | 6           |
| YT-00761 | 6           |
| YT-00762 | 6           |
| YT-00763 | 6           |
| YT-00764 | 6           |
| YT-00765 | 6           |
| YT-00766 | 6           |
| YT-00767 | 6           |
| YT-00768 | 6           |
| YT-00769 | 6           |
| YT-0107  | 13          |
| YT-0109  | 13          |
| YT-0110  | 13          |
| YT-0111  | 13          |
| YT-0112  | 13          |
| YT-0113  | 13          |
| YT-0115  | 13          |
| YT-0117  | 13          |
| YT-0118  | 13          |
| YT-0119  | 13          |
| YT-0120  | 13          |
| YT-0122  | 13          |
| YT-0123  | 13          |
| YT-0125  | 13          |
| YT-0127  | 13          |
| YT-0128  | 13          |
| YT-0132  | 13          |
| YT-01320 | 12          |

| YATO     | page/strona |
|----------|-------------|
| YT-01321 | 12          |
| YT-01322 | 12          |
| YT-01323 | 12          |
| YT-0135  | 19          |
| YT-0136  | 19          |
| YT-0137  | 19          |
| YT-0138  | 19          |
| YT-0139  | 19          |
| YT-0140  | 19          |
| YT-0143  | 19          |
| YT-0150  | 13          |
| YT-0152  | 13          |
| YT-0155  | 11          |
| YT-0156  | 11          |
| YT-0157  | 11          |
| YT-0158  | 11          |
| YT-0159  | 11          |
| YT-0160  | 11          |
| YT-0161  | 11          |
| YT-0162  | 11          |
| YT-0163  | 11          |
| YT-0164  | 11          |
| YT-0165  | 11          |
| YT-0170  | 19          |
| YT-0171  | 19          |
| YT-0172  | 19          |
| YT-0173  | 19          |
| YT-0175  | 19          |
| YT-0180  | 20          |
| YT-0181  | 20          |
| YT-0182  | 20          |
| YT-0183  | 20          |
| YT-0184  | 20          |
| YT-0185  | 20          |
| YT-0186  | 20          |
| YT-0187  | 20          |
| YT-0188  | 20          |
| YT-0189  | 9           |
| YT-0190  | 20          |
| YT-0191  | 9           |
| YT-0192  | 9           |
| YT-0193  | 9           |
| YT-0194  | 9           |
| YT-0195  | 9           |
| YT-0196  | 9           |
| YT-0197  | 9           |
| YT-0198  | 9           |
| YT-0199  | 9           |
| YT-0200  | 9           |
| YT-0201  | 9           |
| YT-0202  | 9           |
| YT-0203  | 9           |
| YT-0204  | 9           |
| YT-0205  | 9           |
| YT-0206  | 9           |
| YT-0207  | 15          |
| YT-0208  | 9           |
| YT-0209  | 15          |
| YT-0211  | 15          |
| YT-0213  | 15          |
| YT-0215  | 15          |
| YT-0217  | 15          |
| YT-0219  | 15          |
| YT-0222  | 15          |
| YT-0223  | 15          |
| YT-0227  | 15          |
| YT-0228  | 15          |
| YT-0232  | 15          |
| YT-02330 | 15          |
| YT-02331 | 15          |
| YT-02332 | 15          |
| YT-02333 | 15          |
| YT-02334 | 15          |
| YT-0248  | 16          |

| YATO    | page/strona |
|---------|-------------|
| YT-0250 | 16          |
| YT-0252 | 16          |
| YT-0255 | 10          |
| YT-0256 | 10          |
| YT-0257 | 10          |
| YT-0258 | 10          |
| YT-0259 | 10          |
| YT-0260 | 10          |
| YT-0261 | 10          |
| YT-0262 | 10          |
| YT-0263 | 10          |
| YT-0264 | 10          |
| YT-0271 | 11          |
| YT-0272 | 11          |
| YT-0273 | 11          |
| YT-0274 | 11          |
| YT-0275 | 11          |
| YT-0276 | 11          |
| YT-0277 | 11          |
| YT-0278 | 11          |
| YT-0279 | 11          |
| YT-0280 | 11          |
| YT-0283 | 19          |
| YT-0284 | 19          |
| YT-0285 | 19          |
| YT-0286 | 19          |
| YT-0287 | 19          |
| YT-0290 | 31          |
| YT-0291 | 35          |
| YT-0292 | 40          |
| YT-0293 | 31          |
| YT-0294 | 35          |
| YT-0295 | 40          |
| YT-0297 | 32          |
| YT-0298 | 36          |
| YT-0299 | 41          |
| YT-0300 | 41          |
| YT-0307 | 31          |
| YT-0308 | 35          |
| YT-0309 | 40          |
| YT-0310 | 31          |
| YT-0311 | 35          |
| YT-0312 | 40          |
| YT-0313 | 31          |
| YT-0314 | 35          |
| YT-0315 | 40          |
| YT-0316 | 31          |
| YT-0317 | 35          |
| YT-0318 | 40          |
| YT-0319 | 31          |
| YT-0320 | 35          |
| YT-0321 | 40          |
| YT-0322 | 31          |
| YT-0323 | 35          |
| YT-0324 | 40          |
| YT-0325 | 31          |
| YT-0326 | 35          |
| YT-0327 | 40          |
| YT-0331 | 32          |
| YT-0332 | 12          |
| YT-0333 | 12          |
| YT-0334 | 12          |
| YT-0335 | 6           |
| YT-0336 | 6           |
| YT-0337 | 6           |
| YT-0338 | 6           |
| YT-0339 | 6           |
| YT-0340 | 6           |
| YT-0341 | 6           |
| YT-0342 | 6           |
| YT-0343 | 6           |
| YT-0344 | 6           |
| YT-0345 | 6           |
| YT-0346 | 6           |

| YATO     | page/strona |
|----------|-------------|
| YT-0347  | 6           |
| YT-0348  | 6           |
| YT-0349  | 6           |
| YT-0350  | 6           |
| YT-0351  | 6           |
| YT-0352  | 6           |
| YT-0353  | 6           |
| YT-0354  | 6           |
| YT-0355  | 6           |
| YT-0356  | 6           |
| YT-0357  | 6           |
| YT-0358  | 6           |
| YT-0359  | 6           |
| YT-0360  | 6           |
| YT-0362  | 6           |
| YT-0363  | 6           |
| YT-0365  | 6           |
| YT-0367  | 12          |
| YT-0368  | 12          |
| YT-0369  | 12          |
| YT-0370  | 12          |
| YT-0371  | 12          |
| YT-0372  | 12          |
| YT-0373  | 12          |
| YT-0374  | 12          |
| YT-0375  | 12          |
| YT-0376  | 12          |
| YT-0377  | 12          |
| YT-0378  | 12          |
| YT-0380  | 12          |
| YT-0381  | 12          |
| YT-0383  | 14          |
| YT-0384  | 14          |
| YT-0385  | 14          |
| YT-0386  | 14          |
| YT-0387  | 14          |
| YT-0388  | 14          |
| YT-0389  | 14          |
| YT-0390  | 14          |
| YT-0391  | 14          |
| YT-0392  | 14          |
| YT-0393  | 14          |
| YT-0394  | 14          |
| YT-0396  | 15          |
| YT-0398  | 15          |
| YT-0400  | 105         |
| YT-0404  | 99          |
| YT-0405  | 99          |
| YT-04051 | 99          |
| YT-04052 | 99          |
| YT-0406  | 99          |
| YT-0407  | 99          |
| YT-0408  | 99          |
| YT-0409  | 99          |
| YT-0410  | 105         |
| YT-0411  | 105         |
| YT-0412  | 105         |
| YT-0413  | 105         |
| YT-0414  | 105         |
| YT-0415  | 105         |
| YT-0416  | 105         |
| YT-0417  | 105         |
| YT-0418  | 105         |
| YT-0419  | 105         |
| YT-0420  | 105         |
| YT-0421  | 305         |
| YT-04211 | 305         |
| YT-0430  | 68          |
| YT-0431  | 68          |
| YT-0432  | 68          |
| YT-0433  | 68          |
| YT-0434  | 68          |
| YT-0435  | 68          |
| YT-0436  | 68          |

| YATO     | page/strona |
|----------|-------------|
| YT-0437  | 68          |
| YT-0438  | 68          |
| YT-0439  | 68          |
| YT-0440  | 68          |
| YT-0441  | 68          |
| YT-0442  | 68          |
| YT-0443  | 68          |
| YT-0450  | 68          |
| YT-0451  | 68          |
| YT-0452  | 68          |
| YT-0453  | 68          |
| YT-0454  | 68          |
| YT-0455  | 68          |
| YT-0456  | 68          |
| YT-0457  | 68          |
| YT-0459  | 104         |
| YT-0461  | 68          |
| YT-0464  | 106         |
| YT-0465  | 106         |
| YT-0466  | 106         |
| YT-0467  | 106         |
| YT-0468  | 106         |
| YT-0470  | 101         |
| YT-04702 | 100         |
| YT-0471  | 101         |
| YT-04712 | 100         |
| YT-0472  | 101         |
| YT-04722 | 100         |
| YT-0473  | 101         |
| YT-0474  | 101         |
| YT-04742 | 100         |
| YT-0475  | 101         |
| YT-04752 | 100         |
| YT-0476  | 101         |
| YT-04762 | 100         |
| YT-0477  | 101         |
| YT-04772 | 100         |
| YT-0478  | 101         |
| YT-04782 | 100         |
| YT-0479  | 101         |
| YT-04792 | 100         |
| YT-0480  | 101         |
| YT-0481  | 101         |
| YT-04812 | 100         |
| YT-0482  | 101         |
| YT-04822 | 100         |
| YT-0483  | 101         |
| YT-04832 | 100         |
| YT-0484  | 104         |
| YT-0485  | 99          |
| YT-0486  | 99          |
| YT-0487  | 99          |
| YT-0488  | 104         |
| YT-0489  | 104         |
| YT-0490  | 104         |
| YT-0491  | 104         |
| YT-0492  | 104         |
| YT-0493  | 104         |
| YT-0494  | 104         |
| YT-0495  | 104         |
| YT-0496  | 104         |
| YT-0497  | 104         |
| YT-0498  | 104         |
| YT-0499  | 104         |
| YT-0500  | 110         |
| YT-0501  | 110         |
| YT-0502  | 110         |
| YT-0503  | 110         |
| YT-0504  | 110         |
| YT-0505  | 110         |
| YT-0506  | 110         |
| YT-0507  | 110         |
| YT-0508  | 110         |
| YT-0509  | 110         |

| YATO     | page/strona |
|----------|-------------|
| YT-0511  | 111         |
| YT-0512  | 111         |
| YT-0519  | 111         |
| YT-0520  | 64          |
| YT-0521  | 64          |
| YT-0530  | 20          |
| YT-0534  | 308         |
| YT-0539  | 299         |
| YT-0540  | 299         |
| YT-0546  | 107         |
| YT-0550  | 107         |
| YT-0560  | 111         |
| YT-0561  | 111         |
| YT-0562  | 111         |
| YT-0563  | 111         |
| YT-0585  | 286         |
| YT-0590  | 285         |
| YT-0591  | 285         |
| YT-0593  | 85; 309     |
| YT-0594  | 276         |
| YT-0595  | 276         |
| YT-0596  | 277         |
| YT-0597  | 277         |
| YT-0598  | 278         |
| YT-0599  | 278         |
| YT-0600  | 278         |
| YT-0601  | 300         |
| YT-06011 | 300         |
| YT-0602  | 282         |
| YT-0603  | 285         |
| YT-0604  | 310         |
| YT-0605  | 313         |
| YT-0606  | 295         |
| YT-0607  | 295         |
| YT-0608  | 295         |
| YT-0609  | 282         |
| YT-0610  | 310         |
| YT-0611  | 311         |
| YT-0612  | 287         |
| YT-0613  | 287         |
| YT-0614  | 287         |
| YT-0615  | 287         |
| YT-0616  | 287         |
| YT-06161 | 293         |
| YT-0617  | 301         |
| YT-0618  | 301         |
| YT-0619  | 314         |
| YT-0620  | 286         |
| YT-0621  | 314         |
| YT-0622  | 302         |
| YT-0623  | 286         |
| YT-0624  | 286         |
| YT-0627  | 299         |
| YT-06271 | 294         |
| YT-0628  | 314         |
| YT-06291 | 290         |
| YT-0630  | 296         |
| YT-0632  | 300         |
| YT-0633  | 300         |
| YT-0635  | 299         |
| YT-0636  | 299         |
| YT-0637  | 299         |
| YT-0638  | 288         |
| YT-0639  | 296         |
| YT-0640  | 283         |
| YT-0641  | 283         |
| YT-0642  | 287         |
| YT-0643  | 315         |
| YT-0644  | 315         |
| YT-0645  | 296         |
| YT-0646  | 297         |
| YT-0647  | 297         |
| YT-0648  | 298         |
| YT-0650  | 297         |

| YATO     | page/strona |
|----------|-------------|
| YT-0651  | 297         |
| YT-0652  | 297         |
| YT-0653  | 298         |
| YT-0657  | 295         |
| YT-0659  | 294         |
| YT-06590 | 294         |
| YT-0660  | 317         |
| YT-0661  | 319         |
| YT-0662  | 319         |
| YT-0663  | 317         |
| YT-0670  | 303         |
| YT-0671  | 312         |
| YT-0672  | 306         |
| YT-0673  | 307         |
| YT-0674  | 307         |
| YT-0677  | 298         |
| YT-0680  | 310         |
| YT-0681  | 311         |
| YT-0682  | 312         |
| YT-0683  | 310         |
| YT-0684  | 309         |
| YT-0685  | 309         |
| YT-0686  | 309         |
| YT-0690  | 280         |
| YT-0691  | 280         |
| YT-0692  | 325         |
| YT-0693  | 325         |
| YT-0694  | 325         |
| YT-0695  | 325         |
| YT-0696  | 325         |
| YT-0697  | 325         |
| YT-0699  | 325         |
| YT-0700  | 279         |
| YT-0701  | 279         |
| YT-0704  | 280         |
| YT-07041 | 280         |
| YT-07042 | 279         |
| YT-07043 | 279         |
| YT-0705  | 279         |
| YT-0707  | 280         |
| YT-0708  | 280         |
| YT-0709  | 280         |
| YT-0710  | 280         |
| YT-0712  | 280         |
| YT-0715  | 280         |
| YT-0716  | 325         |
| YT-0717  | 325         |
| YT-0718  | 325         |
| YT-0720  | 32          |
| YT-0721  | 36          |
| YT-0722  | 41          |
| YT-0723  | 32          |
| YT-0724  | 36          |
| YT-0725  | 41          |
| YT-0726  | 316         |
| YT-0727  | 316         |
| YT-07291 | 32          |
| YT-07292 | 36          |
| YT-07293 | 41          |
| YT-0730  | 31          |
| YT-0731  | 35          |
| YT-0732  | 40          |
| YT-0733  | 32          |

| YATO     | page/strona | YATO     | page/strona | YATO    | page/strona | YATO    | page/strona | YATO    | page/strona | YATO     | page/strona | YATO     | page/strona | YATO    | page/strona |
|----------|-------------|----------|-------------|---------|-------------|---------|-------------|---------|-------------|----------|-------------|----------|-------------|---------|-------------|
| YT-07488 | 83          | YT-0831  | 319         | YT-0939 | 223         | YT-1048 | 74          | YT-1164 | 77          | YT-1244  | 39          | YT-1330  | 64          | YT-1443 | 42          |
| YT-07489 | 83          | YT-0835  | 319         | YT-0940 | 223         | YT-1049 | 74          | YT-1167 | 77          | YT-1246  | 38          | YT-1334  | 66          | YT-1444 | 43          |
| YT-07490 | 83          | YT-0836  | 293         | YT-0941 | 223         | YT-1050 | 74          | YT-1168 | 77          | YT-1247  | 38          | YT-1335  | 66          | YT-1445 | 44          |
| YT-07491 | 83          | YT-0837  | 293         | YT-0942 | 223         | YT-1052 | 74          | YT-1169 | 78          | YT-1248  | 38          | YT-1340  | 65          | YT-1446 | 44          |
| YT-07492 | 83          | YT-0838  | 289         | YT-0950 | 255         | YT-1054 | 74          | YT-1170 | 77          | YT-1249  | 38          | YT-1341  | 65          | YT-1447 | 44          |
| YT-07493 | 83          | YT-08380 | 288         | YT-0951 | 254         | YT-1055 | 74          | YT-1175 | 78          | YT-1250  | 38          | YT-1342  | 65          | YT-1448 | 45          |
| YT-07494 | 83          | YT-08385 | 289         | YT-0952 | 254         | YT-1056 | 315         | YT-1176 | 78          | YT-1251  | 38          | YT-1343  | 77          | YT-1449 | 43          |
| YT-07495 | 83          | YT-0839  | 292         | YT-0953 | 255         | YT-1060 | 75          | YT-1177 | 78          | YT-1252  | 39          | YT-1345  | 65          | YT-1450 | 45          |
| YT-07496 | 83          | YT-0840  | 307         | YT-0956 | 255         | YT-1061 | 75          | YT-1178 | 78          | YT-1253  | 39; 308     | YT-1347  | 65          | YT-1460 | 37          |
| YT-07497 | 83          | YT-0841  | 292         | YT-0957 | 255         | YT-1062 | 75          | YT-1179 | 78          | YT-1254  | 39; 308     | YT-1348  | 65          | YT-1461 | 37          |
| YT-07498 | 83          | YT-0842  | 292         | YT-0959 | 256         | YT-1064 | 75          | YT-1180 | 78          | YT-1255  | 39          | YT-1350  | 65          | YT-1462 | 37          |
| YT-07499 | 83          | YT-0843  | 91          | YT-0960 | 256         | YT-1065 | 79          | YT-1181 | 78          | YT-1258  | 39          | YT-1352  | 65          | YT-1463 | 37          |
| YT-0750  | 82          | YT-08430 | 290         | YT-0961 | 256         | YT-1066 | 79          | YT-1182 | 78          | YT-1259  | 39          | YT-1355  | 65          | YT-1464 | 37          |
| YT-07501 | 84          | YT-0844  | 293         | YT-0963 | 258         | YT-1067 | 75          | YT-1183 | 78          | YT-1261  | 48          | YT-1356  | 39          | YT-1465 | 37          |
| YT-07502 | 84          | YT-0845  | 294         | YT-0964 | 258         | YT-1068 | 79          | YT-1184 | 78          | YT-1262  | 48          | YT-1360  | 66          | YT-1466 | 37          |
| YT-07503 | 84          | YT-0846  | 294         | YT-0965 | 258         | YT-1069 | 79          | YT-1185 | 78          | YT-12621 | 49          | YT-1370  | 291         | YT-1467 | 37          |
| YT-07504 | 84          | YT-0847  | 293         | YT-0967 | 258         | YT-1070 | 76          | YT-1186 | 78          | YT-1264  | 48          | YT-1371  | 291         | YT-1468 | 37          |
| YT-07505 | 84          | YT-0850  | 321; 362    | YT-0970 | 259         | YT-1071 | 76          | YT-1187 | 78          | YT-12641 | 49          | YT-1372  | 291         | YT-1469 | 37          |
| YT-07507 | 84          | YT-08505 | 322; 363    | YT-0974 | 258         | YT-1072 | 76          | YT-1188 | 78          | YT-1265  | 49          | YT-1373  | 291         | YT-1470 | 37          |
| YT-0751  | 82          | YT-0851  | 321; 362    | YT-0975 | 258         | YT-1073 | 76          | YT-1189 | 78          | YT-12651 | 50          | YT-1374  | 291         | YT-1471 | 37          |
| YT-07513 | 84          | YT-08512 | 322; 363    | YT-0976 | 259         | YT-1074 | 76          | YT-1190 | 78          | YT-1266  | 49          | YT-1375  | 291         | YT-1472 | 37          |
| YT-07514 | 84          | YT-0852  | 322; 363    | YT-0977 | 259         | YT-1075 | 76          | YT-1191 | 78          | YT-12661 | 50          | YT-1376  | 291         | YT-1473 | 37          |
| YT-07515 | 84          | YT-08523 | 321; 362    | YT-0980 | 257         | YT-1076 | 76          | YT-1192 | 78          | YT-1267  | 49          | YT-1378  | 291         | YT-1474 | 37          |
| YT-07517 | 85          | YT-08530 | 322; 363    | YT-0981 | 257         | YT-1077 | 76          | YT-1193 | 78          | YT-12671 | 50          | YT-1379  | 291         | YT-1475 | 37          |
| YT-07518 | 85          | YT-0860  | 319         | YT-0982 | 257         | YT-1078 | 76          | YT-1194 | 78          | YT-1268  | 56          | YT-13790 | 291         | YT-1476 | 37          |
| YT-0752  | 82          | YT-0861  | 319         | YT-0983 | 257         | YT-1079 | 76          | YT-1195 | 78          | YT-1269  | 55          | YT-1381  | 291         | YT-1478 | 37          |
| YT-07520 | 85          | YT-0862  | 158         | YT-0984 | 257         | YT-1080 | 76          | YT-1196 | 78          | YT-1270  | 37          | YT-1382  | 292         | YT-1480 | 37          |
| YT-07521 | 85          | YT-0863  | 158         | YT-0990 | 259         | YT-1081 | 76          | YT-1197 | 78          | YT-1271  | 37          | YT-1385  | 292         | YT-1481 | 37          |
| YT-07525 | 85          | YT-0864  | 158         | YT-0993 | 259         | YT-1082 | 76          | YT-1198 | 78          | YT-1272  | 37          | YT-1390  | 292         | YT-1501 | 106         |
| YT-07526 | 85          | YT-0865  | 158         | YT-0994 | 259         | YT-1083 | 76          | YT-1199 | 37          | YT-1273  | 37          | YT-1391  | 292         | YT-1502 | 106         |
| YT-0753  | 82          | YT-0866  | 158         | YT-1000 | 73          | YT-1084 | 76          | YT-1200 | 37          | YT-1274  | 37          | YT-1392  | 292         | YT-1503 | 106         |
| YT-07531 | 83          | YT-0867  | 158         | YT-1001 | 73          | YT-1085 | 76          | YT-1201 | 37          | YT-1275  | 37          | YT-1400  | 30          | YT-1505 | 106         |
| YT-07532 | 83          | YT-0868  | 158         | YT-1002 | 73          | YT-1086 | 76          | YT-1202 | 37          | YT-1276  | 37          | YT-1401  | 29          | YT-1507 | 106         |
| YT-07533 | 83          | YT-0869  | 158         | YT-1003 | 73          | YT-1088 | 76          | YT-1203 | 37          | YT-1277  | 37          | YT-1402  | 29          | YT-1508 | 106         |
| YT-0754  | 83          | YT-0870  | 158         | YT-1004 | 73          | YT-1091 | 76          | YT-1204 | 37          | YT-1278  | 37          | YT-1403  | 29          | YT-1511 | 106         |
| YT-0755  | 83          | YT-0880  | 321         | YT-1005 | 73          | YT-1092 | 76          | YT-1205 | 37          | YT-1279  | 37          | YT-1404  | 29          | YT-1512 | 106         |
| YT-0756  | 82          | YT-0881  | 274         | YT-1006 | 73          | YT-1093 | 76          | YT-1206 | 37          | YT-1280  | 37          | YT-1405  | 29          | YT-1513 | 106         |
| YT-0760  | 82          | YT-0882  | 274         | YT-1007 | 73          | YT-1096 | 76          | YT-1207 | 37          | YT-1281  | 37          | YT-1406  | 29          | YT-1515 | 106         |
| YT-0761  | 82          | YT-0883  | 274         | YT-1008 | 73          | YT-1098 | 76          | YT-1208 | 37          | YT-1282  | 37          | YT-1407  | 29          | YT-1517 | 106         |
| YT-0762  | 84          | YT-0884  | 274         | YT-1009 | 73          | YT-1100 | 76          | YT-1209 | 37          | YT-1283  | 37          | YT-1408  | 29          | YT-1518 | 106         |
| YT-0763  | 84          | YT-0885  | 274         | YT-1010 | 73          | YT-1102 | 76          | YT-1210 | 37          | YT-1284  | 37          | YT-1409  | 29          | YT-1530 | 106         |
| YT-0767  | 84          | YT-0886  | 274         | YT-1011 | 73          | YT-1105 | 76          | YT-1211 | 37          | YT-1285  | 37          | YT-1410  | 29          | YT-1531 | 106         |
| YT-0770  | 82          | YT-0887  | 274         | YT-1012 | 73          | YT-1110 | 76          | YT-1212 | 37          | YT-1286  | 37          | YT-1411  | 29          | YT-1532 | 106         |
| YT-0771  | 82          | YT-08880 | 275         | YT-1013 | 73          | YT-1115 | 76          | YT-1213 | 37          | YT-1289  | 37          | YT-1412  | 29          | YT-1533 | 106         |
| YT-0780  | 85          | YT-08881 | 275         | YT-1014 | 73          | YT-1118 | 76          | YT-1214 | 37          | YT-1291  | 37          | YT-1413  | 29          | YT-1534 | 106         |
| YT-0781  | 85          | YT-08882 | 275         | YT-1015 | 73          | YT-1119 | 76          | YT-1215 | 37          | YT-1292  | 37          | YT-1414  | 29          | YT-1535 | 106         |
| YT-0782  | 85          | YT-0902  | 270         | YT-1016 | 73          | YT-1121 | 76          | YT-1216 | 37          | YT-1295  | 39          | YT-1415  | 29          | YT-1537 | 106         |
| YT-0795  | 315         | YT-0903  | 270         | YT-1017 | 73          | YT-1122 | 76          | YT-1217 | 37          | YT-1296  | 34          | YT-1416  | 29          | YT-1539 | 106         |
| YT-0796  | 315         | YT-0904  | 270         | YT-1018 | 73          | YT-1123 | 76          | YT-1218 | 37          | YT-1297  | 30          | YT-1417  | 29          | YT-1541 | 22          |
| YT-0800  | 316         | YT-0905  | 271         | YT-1019 | 73          | YT-1124 | 76          | YT-1219 | 37          | YT-1301  | 64          | YT-1418  | 29          | YT-1542 | 22          |
| YT-0801  | 316         | YT-0907  | 273         | YT-1020 | 73          | YT-1125 | 76          | YT-1220 | 37          | YT-1302  | 64          | YT-1419  | 29          | YT-1543 | 22          |
| YT-0802  | 316         | YT-0908  | 273         | YT-1022 | 73          | YT-1126 | 76          | YT-1221 | 38          | YT-1303  | 64          | YT-1420  | 29          | YT-1544 | 22          |
| YT-0803  | 316         | YT-0909  | 273         | YT-1025 | 73          | YT-1127 | 76          | YT-1222 | 38          | YT-1304  | 64          | YT-1421  | 29          | YT-1545 | 22          |
| YT-0807  | 316         | YT-0910  | 273         | YT-1027 | 79          | YT-1128 | 76          | YT-1223 | 38          | YT-1305  | 64          | YT-1422  | 29          | YT-1546 | 22          |
| YT-0808  | 316         | YT-0911  | 273         | YT-1028 | 79          | YT-1129 | 76          | YT-1224 | 38          | YT-1306  | 64          | YT-1423  | 29          | YT-1547 | 22          |
| YT-0809  | 316         | YT-0912  | 269         | YT-1029 | 79          | YT-1130 | 76          | YT-1225 | 38          | YT-1307  | 64          | YT-1424  | 29          | YT-1548 | 22          |
| YT-0810  | 316         | YT-0913  | 269         | YT-1030 | 74          | YT-1132 | 76          | YT-1226 | 38          | YT-1308  | 64          | YT-1425  | 30          | YT-1549 | 22          |
| YT-0811  | 316         | YT-0914  | 270         | YT-1031 | 74          | YT-1133 | 76          | YT-1227 | 38          | YT-1309  | 64          | YT-1426  | 30          | YT-1552 | 23          |
| YT-0812  | 308         | YT-09140 | 270         | YT-1032 | 74          | YT-1134 | 76          | YT-1228 | 38          | YT-1310  | 64          | YT-1427  | 30          | YT-1553 | 23          |
| YT-0813  | 309         | YT-09141 | 271         | YT-1033 | 74          | YT-1135 | 76          | YT-1229 | 38          | YT-1311  | 64          | YT-1429  | 30          | YT-1554 | 23          |
| YT-0814  | 309         | YT-0920  | 222; 263    | YT-1034 | 74          | YT-1136 | 76          | YT-1230 | 38          | YT-1312  | 64          | YT-1430  | 30          | YT-1555 | 23          |
| YT-0815  | 308         | YT-0921  | 222; 263    | YT-1035 | 74          | YT-1138 | 76          | YT-1231 | 38          | YT-1313  | 64          | YT-1431  | 30          | YT-1556 | 23          |
| YT-0817  | 308         | YT-0922  | 222; 264    | YT-1036 | 74          | YT-1141 | 76          | YT-1232 | 38          | YT-1314  | 64          | YT-1432  | 30          | YT-1557 | 23          |
| YT-0818  | 308         | YT-0923  | 222; 264    | YT-1037 | 74          | YT-1142 | 76          | YT-1233 | 38          | YT-1315  | 64          | YT-1433  | 30          | YT-1558 | 23          |
| YT-0819  | 308         | YT-0925  | 223; 264    | YT-1038 | 74          | YT-1143 | 76          | YT-1234 | 38          | YT-1316  | 64          | YT-1434  | 30          | YT-1559 | 23          |
| YT-0820  | 276         | YT-0927  | 223         | YT-1039 | 74          | YT-1146 | 76          | YT-1235 | 38          | YT-1317  | 64          | YT-1435  | 30          | YT-1565 | 23          |
| YT-0821  | 276         | YT-0929  | 223         | YT-1040 | 74          | YT-1148 | 76          | YT-1236 | 38          | YT-1318  | 64          | YT-1436  | 30          | YT-1566 | 23          |
| YT-0822  | 276         | YT-0930  | 223         | YT-1041 | 74          | YT-1150 | 76          | YT-1237 | 38          | YT-1319  | 64          | YT-1437  | 30          | YT-1567 | 23          |
| YT-0823  | 276         | YT-0931  | 223         | YT-1042 | 74          | YT-1155 | 77          | YT-1238 | 38          | YT-1320  | 64          | YT-1438  | 30          | YT-1571 | 23          |
| YT-0824  | 276         | YT-0932  | 223         | YT-1043 | 74          | YT-1157 | 79          | YT-1239 | 38          | YT-1322  | 64          | YT-1439  | 42          | YT-1572 | 23          |
| YT-0825  | 276         | YT-0935  | 223         | YT-1044 | 74          | YT-1160 | 77          | YT-1240 | 38          | YT-1323  | 64          | YT-1441  | 42          | YT-1573 | 23          |
| YT-0826  | 276         | YT-0936  | 223         | YT-1045 | 74          | YT-1161 | 77          | YT-1241 | 39          | YT-1324  | 64          | YT-14411 | 43          | YT-1574 | 23          |
| YT-0830  | 319         | YT-0937  | 223         | YT-1046 | 74          | YT-1162 | 77          | YT-1242 | 39          | YT-1326  | 64          | YT-1442  | 42          | YT-1575 | 23          |
| YT-08305 | 319         | YT-0938  | 223         | YT-1047 | 74          | YT-1163 | 77          | YT-1243 | 39          | YT-1328  | 64          | YT-14421 | 43          | YT-1576 | 23          |

| YATO    | page/strona | YATO    | page/strona | YATO     | page/strona | YATO     | page/strona | YATO    | page/strona | YATO     | page/strona | YATO     | page/strona | YATO     | page/strona |
|---------|-------------|---------|-------------|----------|-------------|----------|-------------|---------|-------------|----------|-------------|----------|-------------|----------|-------------|
| YT-1577 | 23          | YT-1659 | 10          | YT-1790  | 73          | YT-1963  | 180         | YT-2082 | 118         | YT-2214  | 212         | YT-2301  | 137         | YT-2490  | 130: 213    |
| YT-1578 | 23          | YT-1660 | 10          | YT-1791  | 73          | YT-1964  | 180         | YT-2083 | 118         | YT-2215  | 212         | YT-2302  | 135         | YT-2491  | 130: 213    |
| YT-1583 | 23          | YT-1661 | 10          | YT-1792  | 73          | YT-1965  | 180         | YT-2084 | 118         | YT-2216  | 212         | YT-2305  | 136         | YT-2492  | 130: 213    |
| YT-1584 | 23          | YT-1662 | 10          | YT-1793  | 73          | YT-1966  | 180         | YT-2085 | 118         | YT-2217  | 212         | YT-2307  | 136         | YT-2493  | 130: 213    |
| YT-1585 | 23          | YT-1663 | 10          | YT-1794  | 73          | YT-1967  | 180         | YT-2086 | 118         | YT-2218  | 212         | YT-2313  | 137         | YT-2494  | 130: 213    |
| YT-1586 | 23          | YT-1664 | 10          | YT-1795  | 73          | YT-1968  | 180         | YT-2090 | 130: 213    | YT-2222  | 130: 213    | YT-2316  | 138         | YT-2495  | 130: 213    |
| YT-1588 | 74          | YT-1665 | 10          | YT-1796  | 73          | YT-1969  | 180         | YT-2091 | 130: 213    | YT-2223  | 130: 213    | YT-2319  | 139         | YT-2510  | 282         |
| YT-1589 | 74          | YT-1666 | 10          | YT-1797  | 73          | YT-1970  | 180         | YT-2101 | 121         | YT-2224  | 130: 213    | YT-23220 | 254: 335    | YT-25105 | 282         |
| YT-1590 | 74          | YT-1667 | 10          | YT-1798  | 73          | YT-1971  | 180         | YT-2102 | 121         | YT-2225  | 130: 213    | YT-2340  | 260         | YT-2511  | 281         |
| YT-1591 | 74          | YT-1668 | 10          | YT-1799  | 73          | YT-1972  | 180         | YT-2103 | 121         | YT-2226  | 130: 213    | YT-2341  | 260         | YT-2512  | 281         |
| YT-1592 | 74          | YT-1669 | 10          | YT-1804  | 75          | YT-1973  | 180         | YT-2104 | 121         | YT-2228  | 197: 214    | YT-2346  | 260         | YT-2513  | 281         |
| YT-1593 | 74          | YT-1670 | 10          | YT-1807  | 75          | YT-1974  | 140: 195    | YT-2105 | 121         | YT-2229  | 197: 214    | YT-2350  | 260         | YT-2514  | 281         |
| YT-1594 | 74          | YT-1671 | 10          | YT-1808  | 75          | YT-1976  | 184         | YT-2107 | 121         | YT-2230  | 197: 214    | YT-2351  | 260         | YT-2515  | 281         |
| YT-1595 | 74          | YT-1672 | 10          | YT-1809  | 75          | YT-19763 | 195         | YT-2109 | 121         | YT-2231  | 197: 214    | YT-2353  | 260         | YT-2516  | 281         |
| YT-1596 | 74          | YT-1673 | 10          | YT-1843  | 183         | YT-19764 | 195         | YT-2110 | 121         | YT-2232  | 197: 214    | YT-2356  | 260         | YT-2517  | 281         |
| YT-1597 | 74          | YT-1674 | 11          | YT-1844  | 183         | YT-19765 | 195         | YT-2112 | 121         | YT-2233  | 197: 214    | YT-2357  | 260         | YT-2518  | 281         |
| YT-1598 | 74          | YT-1675 | 11          | YT-1845  | 183         | YT-19766 | 195         | YT-2121 | 122         | YT-2234  | 197: 214    | YT-2361  | 260         | YT-2519  | 281         |
| YT-1599 | 74          | YT-1676 | 11          | YT-1846  | 183         | YT-19767 | 195         | YT-2122 | 122         | YT-2235  | 197: 214    | YT-2363  | 260         | YT-2520  | 281         |
| YT-1600 | 89          | YT-1677 | 11          | YT-1847  | 183         | YT-1980  | 126         | YT-2123 | 122         | YT-2240  | 136         | YT-2364  | 260         | YT-2521  | 281         |
| YT-1601 | 17          | YT-1678 | 11          | YT-1848  | 183         | YT-1981  | 126         | YT-2124 | 122         | YT-2242  | 135         | YT-2370  | 260         | YT-2522  | 281         |
| YT-1602 | 17          | YT-1679 | 11          | YT-1849  | 183         | YT-1982  | 126         | YT-2126 | 122         | YT-2243  | 136         | YT-2371  | 260         | YT-2523  | 281         |
| YT-1603 | 17          | YT-1680 | 11          | YT-1851  | 183         | YT-1983  | 126         | YT-2127 | 122         | YT-2244  | 135         | YT-2372  | 260         | YT-2535  | 313         |
| YT-1604 | 17          | YT-1681 | 11          | YT-1852  | 183         | YT-1984  | 126         | YT-2128 | 122         | YT-2245  | 134         | YT-2373  | 261         | YT-2536  | 313         |
| YT-1605 | 17          | YT-1682 | 11          | YT-1853  | 183         | YT-1985  | 126         | YT-2129 | 122         | YT-2246  | 134         | YT-2374  | 261         | YT-2537  | 313         |
| YT-1606 | 17          | YT-1683 | 11          | YT-1854  | 183         | YT-1986  | 126         | YT-2130 | 125         | YT-2247  | 134         | YT-2375  | 261         | YT-2538  | 309         |
| YT-1607 | 17          | YT-1684 | 11          | YT-1855  | 183         | YT-1987  | 126         | YT-2136 | 125         | YT-2248  | 134         | YT-2376  | 261         | YT-2539  | 284         |
| YT-1608 | 17          | YT-1685 | 11          | YT-1856  | 183         | YT-1988  | 126         | YT-2137 | 125         | YT-2249  | 134         | YT-2380  | 262         | YT-2540  | 284         |
| YT-1609 | 17          | YT-1686 | 11          | YT-18600 | 140: 184    | YT-1989  | 126         | YT-2138 | 125         | YT-2250  | 135         | YT-2381  | 262         | YT-2541  | 284         |
| YT-1610 | 17          | YT-1687 | 11          | YT-18602 | 140: 184    | YT-1990  | 126         | YT-2139 | 125         | YT-2251  | 135         | YT-2382  | 262         | YT-2542  | 285         |
| YT-1611 | 17          | YT-1688 | 11          | YT-18610 | 140: 184    | YT-1991  | 126         | YT-2140 | 126         | YT-2254  | 136         | YT-2383  | 262         | YT-2543  | 285         |
| YT-1612 | 17          | YT-1689 | 11          | YT-18611 | 140: 184    | YT-1992  | 126         | YT-2141 | 126         | YT-2255  | 135         | YT-2384  | 262         | YT-2544  | 313         |
| YT-1613 | 17          | YT-1690 | 11          | YT-18612 | 140: 184    | YT-1993  | 126         | YT-2142 | 126         | YT-2256  | 135         | YT-2385  | 262         | YT-2545  | 283         |
| YT-1614 | 17          | YT-1691 | 11          | YT-1900  | 182: 237    | YT-1994  | 126         | YT-2143 | 126         | YT-2260  | 140         | YT-2390  | 262         | YT-2546  | 313         |
| YT-1615 | 18          | YT-1692 | 11          | YT-1901  | 182: 237    | YT-1995  | 126         | YT-2144 | 126         | YT-2261  | 140         | YT-2391  | 262         | YT-2547  | 313         |
| YT-1616 | 18          | YT-1693 | 11          | YT-1902  | 182: 237    | YT-2006  | 115         | YT-2145 | 126         | YT-2262  | 140         | YT-2392  | 262         | YT-2571  | 98          |
| YT-1617 | 18          | YT-1694 | 11          | YT-1910  | 181         | YT-2007  | 115         | YT-2146 | 126         | YT-2263  | 140         | YT-2393  | 262         | YT-2575  | 92          |
| YT-1618 | 18          | YT-1695 | 11          | YT-1911  | 181         | YT-2008  | 115         | YT-2147 | 126         | YT-2264  | 140         | YT-2394  | 262         | YT-2576  | 92          |
| YT-1619 | 18          | YT-1696 | 11          | YT-1912  | 181         | YT-2016  | 115         | YT-2151 | 127         | YT-2266  | 139         | YT-2395  | 262         | YT-2577  | 92          |
| YT-1620 | 18          | YT-1702 | 326         | YT-1913  | 182: 237    | YT-2018  | 115         | YT-2152 | 127         | YT-2267  | 139         | YT-2396  | 262         | YT-25802 | 95          |
| YT-1621 | 18          | YT-1704 | 326         | YT-1914  | 182: 237    | YT-2026  | 115         | YT-2153 | 127         | YT-2268  | 138         | YT-2397  | 262         | YT-25803 | 95          |
| YT-1622 | 18          | YT-1706 | 326         | YT-1915  | 181         | YT-2028  | 115         | YT-2155 | 127         | YT-2270  | 137         | YT-2398  | 262         | YT-25804 | 95          |
| YT-1626 | 20          | YT-1707 | 326         | YT-1916  | 181         | YT-2029  | 116         | YT-2156 | 127         | YT-2271  | 136         | YT-2399  | 262         | YT-25805 | 95          |
| YT-1627 | 20          | YT-1709 | 326         | YT-1918  | 181         | YT-2030  | 116         | YT-2160 | 129         | YT-2272  | 139         | YT-2401  | 262         | YT-25806 | 95          |
| YT-1628 | 20          | YT-1711 | 326         | YT-1919  | 181         | YT-2031  | 116         | YT-2161 | 129         | YT-2273  | 139         | YT-2402  | 262         | YT-25807 | 95          |
| YT-1629 | 20          | YT-1713 | 326         | YT-1920  | 182         | YT-2036  | 115         | YT-2162 | 129         | YT-2274  | 139         | YT-2403  | 262         | YT-25808 | 95          |
| YT-1630 | 20          | YT-1714 | 326         | YT-1922  | 181         | YT-2037  | 115         | YT-2163 | 129         | YT-2275  | 138         | YT-2404  | 262         | YT-25809 | 95          |
| YT-1631 | 20          | YT-1715 | 326         | YT-1923  | 181         | YT-2039  | 124         | YT-2164 | 129         | YT-2276  | 138         | YT-2405  | 262         | YT-25810 | 95          |
| YT-1632 | 20          | YT-1719 | 327         | YT-1924  | 182         | YT-2046  | 124         | YT-2165 | 24          | YT-2277  | 138         | YT-2406  | 262         | YT-25811 | 95          |
| YT-1633 | 20          | YT-1720 | 327         | YT-1925  | 182: 237    | YT-2047  | 124         | YT-2166 | 24          | YT-2278  | 137         | YT-2407  | 262         | YT-25831 | 95          |
| YT-1634 | 20          | YT-1721 | 327         | YT-1930  | 183         | YT-2048  | 124         | YT-2167 | 24          | YT-2279  | 139         | YT-2449  | 127         | YT-25832 | 95          |
| YT-1635 | 20          | YT-1751 | 302         | YT-1933  | 180         | YT-2050  | 124         | YT-2168 | 24          | YT-2280  | 139         | YT-2450  | 127         | YT-25833 | 95          |
| YT-1636 | 20          | YT-1752 | 301         | YT-1939  | 183: 238    | YT-2051  | 124         | YT-2170 | 24          | YT-2283  | 136         | YT-2451  | 127         | YT-25834 | 95          |
| YT-1637 | 20          | YT-1753 | 301         | YT-1940  | 115         | YT-2052  | 124         | YT-2171 | 24          | YT-2284  | 137         | YT-2452  | 127         | YT-25835 | 95          |
| YT-1638 | 20          | YT-1754 | 301         | YT-1941  | 115         | YT-2054  | 124         | YT-2172 | 24          | YT-2285  | 137         | YT-2453  | 127         | YT-25836 | 95          |
| YT-1639 | 20          | YT-1756 | 301         | YT-1942  | 115         | YT-2055  | 124         | YT-2173 | 24          | YT-2286  | 137         | YT-2459  | 127         | YT-25837 | 95          |
| YT-1640 | 20          | YT-1757 | 278         | YT-1943  | 115         | YT-2056  | 124         | YT-2174 | 24          | YT-22861 | 137         | YT-2460  | 127         | YT-25838 | 95          |
| YT-1641 | 20          | YT-1762 | 302         | YT-1944  | 115         | YT-2057  | 124         | YT-2175 | 24          | YT-22862 | 137         | YT-2461  | 128         | YT-25839 | 95          |
| YT-1642 | 20          | YT-1763 | 174: 323    | YT-1945  | 115         | YT-2058  | 124         | YT-2176 | 24          | YT-22870 | 184         | YT-2463  | 128         | YT-25840 | 95          |
| YT-1643 | 20          | YT-1764 | 174: 323    | YT-1946  | 115         | YT-2060  | 124         | YT-2177 | 24          | YT-22871 | 184         | YT-2466  | 128         | YT-25841 | 95          |
| YT-1644 | 20          | YT-1765 | 174: 323    | YT-1947  | 115         | YT-2061  | 124         | YT-2178 | 24          | YT-22872 | 184         | YT-2468  | 128         | YT-25842 | 95          |
| YT-1645 | 20          | YT-1766 | 174: 323    | YT-1948  | 115         | YT-2062  | 124         | YT-2179 | 24          | YT-22873 | 184         | YT-2469  | 128         | YT-25843 | 95          |
| YT-1646 | 20          | YT-1767 | 174: 323    | YT-1949  | 124         | YT-2063  | 124         | YT-2180 | 215         | YT-22874 | 184         | YT-2472  | 128         | YT-25844 | 95          |
| YT-1647 | 20          | YT-1768 | 174: 323    | YT-1950  | 123         | YT-2064  | 124         | YT-2181 | 215         | YT-22875 | 184         | YT-2473  | 128         | YT-25845 | 95          |
| YT-1648 | 20          | YT-1769 | 174: 323    | YT-1951  | 123         | YT-2066  | 116         | YT-2182 | 215         | YT-2290  | 139         | YT-2476  | 128         | YT-25846 | 95          |
| YT-1649 | 20          | YT-1780 | 73          | YT-1952  | 123         | YT-2067  | 116         | YT-2183 | 215         | YT-2292  | 138         | YT-2480  | 130: 213    | YT-25852 | 95          |
| YT-1650 | 20          | YT-1781 | 73          | YT-1953  | 123         | YT-2069  | 130: 213    | YT-2201 | 130: 213    | YT-2293  | 138         | YT-2481  | 130: 213    | YT-25853 | 95          |
| YT-1651 | 10          | YT-1782 | 73          | YT-1954  | 123         | YT-2070  | 130: 213    | YT-2203 | 130: 213    | YT-22930 | 138         | YT-2482  | 130: 213    | YT-25854 | 95          |
| YT-1652 | 10          | YT-1783 | 73          | YT-1955  | 123         | YT-2071  | 24          | YT-2204 | 130: 213    | YT-2294  | 139         | YT-2483  | 130: 213    | YT-25855 | 95          |
| YT-1653 | 10          | YT-1784 | 73          | YT-1956  | 123         | YT-2072  | 24          | YT-2205 | 130: 213    | YT-2295  | 138         | YT-2484  | 130: 213    | YT-25856 | 95          |
| YT-1654 | 10          | YT-1785 | 73          | YT-1957  | 130: 213    | YT-2073  | 24          | YT-2206 | 130: 213    | YT-2296  | 134         | YT-2485  | 130: 213    | YT-25857 | 95          |
| YT-1655 | 10          | YT-1786 | 73          | YT-1958  | 130: 213    | YT-2074  | 24          | YT-2210 | 212         | YT-2297  | 134         | YT-2486  | 130: 213    | YT-25861 | 95          |
| YT-1656 | 10          | YT-1787 | 73          | YT-1960  | 181         | YT-2075  | 24          | YT-2211 | 212         | YT-2298  | 134         | YT-2487  | 130: 213    | YT-25862 | 95          |
| YT-1657 | 10          | YT-1788 | 73          | YT-1961  | 181         | YT-2080  | 118         | YT-2212 | 212         | YT-2299  | 134         | YT-2488  | 130: 213    | YT-25863 | 95          |
| YT-1658 | 10          | YT-1789 | 73          | YT-1962  | 181         | YT-2081  | 118         | YT-2213 | 212         | YT-2300  | 135         | YT-2489  | 130: 213    | YT-2601  | 93          |

| YATO    | page/strona | YATO    | page/strona | YATO     | page/strona | YATO    | page/strona | YATO     | page/strona | YATO    | page/strona | YATO    | page/strona | YATO     | page/strona |
|---------|-------------|---------|-------------|----------|-------------|---------|-------------|----------|-------------|---------|-------------|---------|-------------|----------|-------------|
| YT-2602 | 93          | YT-2700 | 89          | YT-2789  | 91          | YT-2918 | 212         | YT-3001  | 251         | YT-3243 | 167         | YT-3333 | 170         | YT-3520  | 18          |
| YT-2603 | 93          | YT-2701 | 89          | YT-2790  | 92          | YT-2919 | 212         | YT-3002  | 251         | YT-3244 | 167         | YT-3334 | 170         | YT-3521  | 18          |
| YT-2604 | 93          | YT-2702 | 89          | YT-2791  | 92          | YT-2920 | 212         | YT-3003  | 251         | YT-3245 | 167         | YT-3336 | 170         | YT-3522  | 18          |
| YT-2606 | 93          | YT-2703 | 89          | YT-2795  | 92          | YT-2921 | 212         | YT-3004  | 251         | YT-3246 | 167         | YT-3338 | 170         | YT-3523  | 18          |
| YT-2607 | 93          | YT-2704 | 89          | YT-2797  | 97          | YT-2926 | 172         | YT-3005  | 251         | YT-3247 | 167         | YT-3343 | 170         | YT-3524  | 18          |
| YT-2608 | 93          | YT-2705 | 89          | YT-2798  | 97          | YT-2927 | 172         | YT-3007  | 251         | YT-3248 | 167         | YT-3345 | 170         | YT-3525  | 18          |
| YT-2609 | 93          | YT-2706 | 89          | YT-2799  | 98          | YT-2928 | 172         | YT-3008  | 251         | YT-3249 | 167         | YT-3346 | 170         | YT-3526  | 18          |
| YT-2610 | 93          | YT-2708 | 89          | YT-2800  | 99          | YT-2929 | 172         | YT-3009  | 251         | YT-3250 | 167         | YT-3349 | 170         | YT-3527  | 18          |
| YT-2612 | 93          | YT-2709 | 89          | YT-2801  | 99          | YT-2930 | 172         | YT-3010  | 251         | YT-3251 | 167         | YT-3350 | 170         | YT-3528  | 18          |
| YT-2613 | 93          | YT-2710 | 89          | YT-2802  | 99          | YT-2931 | 172         | YT-3016  | 251         | YT-3252 | 167         | YT-3351 | 170         | YT-3529  | 18          |
| YT-2614 | 93          | YT-2711 | 89          | YT-2804  | 97          | YT-2932 | 172         | YT-3017  | 251         | YT-3253 | 167         | YT-3353 | 170         | YT-3530  | 18          |
| YT-2615 | 93          | YT-2712 | 89          | YT-2805  | 97          | YT-2933 | 172         | YT-3018  | 251         | YT-3254 | 167         | YT-3370 | 170         | YT-3531  | 18          |
| YT-2618 | 93          | YT-2715 | 88          | YT-2806  | 98          | YT-2934 | 172         | YT-3019  | 251         | YT-3255 | 167         | YT-3371 | 170         | YT-3532  | 18          |
| YT-2619 | 93          | YT-2716 | 88          | YT-2808  | 97          | YT-2935 | 172         | YT-3022  | 251         | YT-3256 | 167         | YT-3372 | 170         | YT-3533  | 18          |
| YT-2620 | 88          | YT-2717 | 88          | YT-2810  | 99          | YT-2937 | 172         | YT-3023  | 251         | YT-3257 | 167         | YT-3373 | 170         | YT-3534  | 18          |
| YT-2621 | 88          | YT-2718 | 88          | YT-2811  | 99          | YT-2939 | 172         | YT-3024  | 251         | YT-3258 | 167         | YT-3374 | 170         | YT-3535  | 18          |
| YT-2622 | 88          | YT-2719 | 88          | YT-2812  | 99          | YT-2940 | 172         | YT-3025  | 251         | YT-3259 | 167         | YT-3376 | 170         | YT-3536  | 18          |
| YT-2623 | 88          | YT-2720 | 88          | YT-2815  | 96          | YT-2941 | 172         | YT-3026  | 251         | YT-3261 | 168         | YT-3377 | 170         | YT-3590  | 196         |
| YT-2624 | 88          | YT-2721 | 88          | YT-2816  | 96          | YT-2942 | 172         | YT-3027  | 251         | YT-3262 | 168         | YT-3380 | 171         | YT-3591  | 196         |
| YT-2625 | 88          | YT-2722 | 88          | YT-2817  | 96          | YT-2943 | 172         | YT-3028  | 251         | YT-3263 | 168         | YT-3381 | 171         | YT-3600  | 218         |
| YT-2626 | 88          | YT-2723 | 88          | YT-2818  | 96          | YT-2944 | 172         | YT-3030  | 251         | YT-3264 | 168         | YT-3382 | 171         | YT-3601  | 218         |
| YT-2627 | 88          | YT-2724 | 88          | YT-2819  | 96          | YT-2945 | 172         | YT-3031  | 251         | YT-3265 | 168         | YT-3400 | 187         | YT-36011 | 218         |
| YT-2628 | 88          | YT-2725 | 88          | YT-2820  | 96          | YT-2946 | 172         | YT-3032  | 251         | YT-3266 | 168         | YT-3401 | 187         | YT-36012 | 218         |
| YT-2629 | 88          | YT-2726 | 88          | YT-2821  | 96          | YT-2947 | 172         | YT-3071  | 239         | YT-3267 | 168         | YT-3402 | 187         | YT-3609  | 218         |
| YT-2630 | 88          | YT-2727 | 88          | YT-2822  | 96          | YT-2948 | 172         | YT-3072  | 239         | YT-3268 | 168         | YT-3403 | 187         | YT-36092 | 218         |
| YT-2631 | 88          | YT-2728 | 88          | YT-2823  | 96          | YT-2949 | 172         | YT-3073  | 239         | YT-3269 | 168         | YT-3404 | 187         | YT-36095 | 219         |
| YT-2633 | 93          | YT-2729 | 88          | YT-2824  | 96          | YT-2950 | 172         | YT-3074  | 239         | YT-3270 | 168         | YT-3405 | 187         | YT-3610  | 219         |
| YT-2634 | 93          | YT-2730 | 88          | YT-2825  | 96          | YT-2951 | 172         | YT-3076  | 239         | YT-3271 | 168         | YT-3407 | 187         | YT-36119 | 220         |
| YT-2635 | 93          | YT-2731 | 88          | YT-2826  | 96          | YT-2952 | 172         | YT-3077  | 239         | YT-3272 | 168         | YT-3408 | 187         | YT-3612  | 219         |
| YT-2636 | 93          | YT-2732 | 88          | YT-2827  | 96          | YT-2953 | 172         | YT-3078  | 239         | YT-3273 | 168         | YT-3409 | 187         | YT-36129 | 220         |
| YT-2637 | 93          | YT-2733 | 88          | YT-2828  | 96          | YT-2954 | 172         | YT-3079  | 239         | YT-3274 | 168         | YT-3410 | 187         | YT-3613  | 219         |
| YT-2638 | 93          | YT-2734 | 88          | YT-2830  | 141         | YT-2955 | 172         | YT-3081  | 239         | YT-3275 | 168         | YT-3411 | 187         | YT-3617  | 220; 263    |
| YT-2639 | 93          | YT-2741 | 93          | YT-2840  | 89          | YT-2956 | 172         | YT-3082  | 239         | YT-3276 | 168         | YT-3412 | 187         | YT-3618  | 220; 263    |
| YT-2640 | 93          | YT-2742 | 93          | YT-2841  | 89          | YT-2957 | 172         | YT-3083  | 239         | YT-3277 | 168         | YT-3413 | 187         | YT-3630  | 220         |
| YT-2641 | 93          | YT-2743 | 93          | YT-2842  | 89          | YT-2958 | 172         | YT-3084  | 239         | YT-3278 | 168         | YT-3414 | 187         | YT-3631  | 220         |
| YT-2642 | 93          | YT-2744 | 93          | YT-2843  | 89          | YT-2959 | 172         | YT-3101  | 185         | YT-3279 | 168         | YT-3415 | 187         | YT-3632  | 220         |
| YT-2643 | 93          | YT-2745 | 93          | YT-2844  | 89          | YT-2960 | 173         | YT-3102  | 185         | YT-3280 | 168         | YT-3416 | 187         | YT-3634  | 220         |
| YT-2644 | 93          | YT-2746 | 93          | YT-2845  | 89          | YT-2961 | 173         | YT-3103  | 185         | YT-3281 | 168         | YT-3417 | 187         | YT-3635  | 220         |
| YT-2645 | 93          | YT-2748 | 93          | YT-2846  | 89          | YT-2962 | 173         | YT-3106  | 185         | YT-3282 | 168         | YT-3421 | 187         | YT-3636  | 220         |
| YT-2647 | 93          | YT-2750 | 93          | YT-2847  | 89          | YT-2963 | 173         | YT-3107  | 185         | YT-3283 | 168         | YT-3430 | 187         | YT-3637  | 220         |
| YT-2648 | 93          | YT-2752 | 93          | YT-28480 | 292         | YT-2964 | 173         | YT-3108  | 185         | YT-3284 | 168         | YT-3431 | 187         | YT-3639  | 220         |
| YT-2649 | 93          | YT-2753 | 93          | YT-2861  | 141; 246    | YT-2965 | 173         | YT-3130  | 185         | YT-3285 | 168         | YT-3432 | 187         | YT-3640  | 220         |
| YT-2650 | 93          | YT-2754 | 93          | YT-2862  | 141; 246    | YT-2966 | 173         | YT-3133  | 185         | YT-3286 | 168         | YT-3433 | 187         | YT-3641  | 220         |
| YT-2651 | 93          | YT-2756 | 93          | YT-2863  | 141; 246    | YT-2967 | 173         | YT-3134  | 185         | YT-3287 | 168         | YT-3434 | 187         | YT-3642  | 220         |
| YT-2653 | 93          | YT-2757 | 93          | YT-28631 | 141         | YT-2968 | 173         | YT-3150  | 185         | YT-3288 | 168         | YT-3435 | 187         | YT-3700  | 230         |
| YT-2654 | 93          | YT-2760 | 88          | YT-2864  | 141         | YT-2969 | 173         | YT-3160  | 186         | YT-3289 | 168         | YT-3440 | 188         | YT-3701  | 230         |
| YT-2655 | 93          | YT-2761 | 88          | YT-2865  | 323         | YT-2970 | 173         | YT-3161  | 186         | YT-3290 | 168         | YT-3441 | 188         | YT-3702  | 230         |
| YT-2656 | 93          | YT-2762 | 88          | YT-2866  | 323         | YT-2971 | 173         | YT-3163  | 186         | YT-3291 | 168         | YT-3442 | 188         | YT-3703  | 231         |
| YT-2657 | 93          | YT-2763 | 88          | YT-28950 | 169         | YT-2972 | 173         | YT-31631 | 186         | YT-3292 | 168         | YT-3443 | 188         | YT-3704  | 231         |
| YT-2658 | 93          | YT-2764 | 88          | YT-28951 | 169         | YT-2973 | 173         | YT-3200  | 185         | YT-3293 | 168         | YT-3444 | 188         | YT-3705  | 231         |
| YT-2661 | 93          | YT-2765 | 88          | YT-28952 | 169         | YT-2974 | 173         | YT-3201  | 185         | YT-3294 | 168         | YT-3445 | 188         | YT-3706  | 231         |
| YT-2663 | 93          | YT-2766 | 88          | YT-28953 | 169         | YT-2975 | 172         | YT-3202  | 185         | YT-3295 | 168         | YT-3460 | 186         | YT-3707  | 231         |
| YT-2665 | 93          | YT-2767 | 88          | YT-28954 | 169         | YT-2976 | 173         | YT-3203  | 185         | YT-3296 | 168         | YT-3461 | 186         | YT-3708  | 231         |
| YT-2667 | 93          | YT-2768 | 88          | YT-28955 | 169         | YT-2977 | 173         | YT-3204  | 185         | YT-3297 | 168         | YT-3462 | 186         | YT-3712  | 231         |
| YT-2668 | 94          | YT-2769 | 88          | YT-28956 | 169         | YT-2978 | 172         | YT-3206  | 185         | YT-3298 | 168         | YT-3500 | 17          | YT-3713  | 231         |
| YT-2669 | 94          | YT-2770 | 88          | YT-28957 | 169         | YT-2979 | 172         | YT-3220  | 186         | YT-3299 | 168         | YT-3501 | 17          | YT-3714  | 231         |
| YT-2670 | 94          | YT-2771 | 88          | YT-28958 | 169         | YT-2980 | 173         | YT-3221  | 186         | YT-3300 | 168         | YT-3502 | 17          | YT-37160 | 232         |
| YT-2675 | 88          | YT-2772 | 88          | YT-28959 | 169         | YT-2981 | 173         | YT-3222  | 186         | YT-3303 | 170         | YT-3503 | 17          | YT-37161 | 232         |
| YT-2676 | 88          | YT-2773 | 88          | YT-28960 | 169         | YT-2982 | 173         | YT-3223  | 186         | YT-3304 | 170         | YT-3504 | 17          | YT-37162 | 232         |
| YT-2677 | 88          | YT-2774 | 88          | YT-28961 | 169         | YT-2983 | 173         | YT-3224  | 186         | YT-3306 | 170         | YT-3505 | 17          | YT-37163 | 232         |
| YT-2678 | 88          | YT-2775 | 88          | YT-28962 | 169         | YT-2984 | 173         | YT-3225  | 186         | YT-3308 | 170         | YT-3506 | 17          | YT-37164 | 232         |
| YT-2679 | 88          | YT-2776 | 88          | YT-28963 | 169         | YT-2985 | 173         | YT-3230  | 186         | YT-3311 | 170         | YT-3507 | 17          | YT-37170 | 232         |
| YT-2682 | 88          | YT-2777 | 88          | YT-28964 | 169         | YT-2986 | 173         | YT-3231  | 186         | YT-3313 | 170         | YT-3508 | 17          | YT-3725  | 169         |
| YT-2683 | 88          | YT-2778 | 88          | YT-28965 | 169         | YT-2987 | 173         | YT-3232  | 186         | YT-3315 | 170         | YT-3509 | 17          | YT-3726  | 169         |
| YT-2686 | 88          | YT-2779 | 88          | YT-28966 | 169         | YT-2988 | 173         | YT-3233  | 186         | YT-3317 | 170         | YT-3510 | 17          | YT-3727  | 169         |
| YT-2687 | 88          | YT-2780 | 98          | YT-28967 | 169         | YT-2989 | 173         | YT-3234  | 186         | YT-3318 | 170         | YT-3511 | 17          | YT-3728  | 169         |
| YT-2688 | 88          | YT-2781 | 91          | YT-2900  | 212         | YT-2990 | 173         | YT-3235  | 186         | YT-3321 | 170         | YT-3512 | 17          | YT-3730  | 230         |
| YT-2689 | 88          | YT-2782 | 90          | YT-2910  | 212         | YT-2991 | 173         | YT-3236  | 167         | YT-3322 | 170         | YT-3513 | 17          | YT-3735  | 196; 233    |
| YT-2690 | 88          | YT-2783 | 90          | YT-2911  | 212         | YT-2992 | 173         | YT-3237  | 167         | YT-3323 | 170         | YT-3514 | 17          | YT-3736  | 196; 233    |
| YT-2691 | 88          | YT-2784 | 90          | YT-2912  | 212         | YT-2993 | 173         | YT-3238  | 167         | YT-3324 | 170         | YT-3515 | 17          | YT-3740  | 196         |
| YT-2692 | 88          | YT-2785 | 91          | YT-2913  | 212         | YT-2994 | 173         | YT-3239  | 167         | YT-3327 | 170         | YT-3516 | 17          | YT-3750  | 72          |
| YT-2693 | 88          | YT-2786 | 91          | YT-2914  | 212         | YT-2995 | 173         | YT-3240  | 167         | YT-3329 | 170         | YT-3517 | 17          | YT-3751  | 72          |
| YT-2694 | 88          | YT-2787 | 90          | YT-2916  | 212         | YT-2996 | 173         | YT-3241  | 167         | YT-3330 | 170         | YT-3518 | 18          | YT-3752  | 72          |
| YT-2699 | 89          | YT-2788 | 90          | YT-2917  | 212         | YT-2997 | 173         | YT-3242  | 167         | YT-3332 | 170         | YT-3519 | 18          | YT-3753  | 72          |

| YATO    | page/strom | YATO     | page/strom | YATO    | page/strom | YATO    | page/strom | YATO    | page/strom | YATO     | page/strom | YATO     | page/strom | YATO     | page/strom |
|---------|------------|----------|------------|---------|------------|---------|------------|---------|------------|----------|------------|----------|------------|----------|------------|
| YT-3754 | 72         | YT-3835  | 33         | YT-3924 | 164        | YT-4163 | 166        | YT-4364 | 166        | YT-4521  | 149        | YT-4712  | 151        | YT-4852  | 14         |
| YT-3755 | 72         | YT-3839  | 34         | YT-3926 | 164        | YT-4164 | 166        | YT-4367 | 166        | YT-4522  | 149        | YT-47121 | 151        | YT-4853  | 14         |
| YT-3756 | 72         | YT-3840  | 34         | YT-3928 | 164        | YT-4165 | 166        | YT-4369 | 166        | YT-4523  | 149        | YT-4713  | 152        | YT-4854  | 14         |
| YT-3757 | 72         | YT-3841  | 34         | YT-3930 | 164        | YT-4166 | 166        | YT-4370 | 166        | YT-4524  | 149        | YT-4714  | 152        | YT-4860  | 16         |
| YT-3758 | 72         | YT-3842  | 34         | YT-3932 | 164        | YT-4167 | 166        | YT-4373 | 166        | YT-4525  | 149        | YT-47141 | 151        | YT-4861  | 16         |
| YT-3759 | 72         | YT-3843  | 34         | YT-3935 | 164        | YT-4168 | 166        | YT-4375 | 166        | YT-4526  | 149        | YT-47142 | 151        | YT-4862  | 16         |
| YT-3760 | 72         | YT-3844  | 34         | YT-3938 | 164        | YT-4169 | 166        | YT-4376 | 166        | YT-4527  | 149        | YT-47143 | 151        | YT-4863  | 16         |
| YT-3761 | 72         | YT-3845  | 34         | YT-3942 | 164        | YT-4170 | 166        | YT-4379 | 166        | YT-4550  | 146        | YT-47144 | 151        | YT-4864  | 16         |
| YT-3762 | 72         | YT-3846  | 34         | YT-3944 | 164        | YT-4171 | 166        | YT-4380 | 166        | YT-4551  | 146        | YT-47145 | 151        | YT-4865  | 16         |
| YT-3763 | 72         | YT-3847  | 34         | YT-3945 | 164        | YT-4172 | 166        | YT-4383 | 166        | YT-4552  | 146        | YT-47146 | 151        | YT-48651 | 16         |
| YT-3764 | 72         | YT-3848  | 34         | YT-3946 | 164        | YT-4173 | 166        | YT-4385 | 166        | YT-4553  | 146        | YT-47147 | 151        | YT-4870  | 8          |
| YT-3765 | 72         | YT-3849  | 34         | YT-3949 | 164        | YT-4174 | 166        | YT-4390 | 166        | YT-4560  | 147        | YT-47148 | 151        | YT-4871  | 8          |
| YT-3766 | 72         | YT-3850  | 34         | YT-3950 | 164        | YT-4175 | 166        | YT-4400 | 170        | YT-4561  | 147        | YT-47149 | 151        | YT-4872  | 8          |
| YT-3767 | 72         | YT-3851  | 34; 308    | YT-3951 | 164        | YT-4176 | 166        | YT-4401 | 170        | YT-4562  | 147        | YT-47150 | 151        | YT-4873  | 8          |
| YT-3768 | 72         | YT-3852  | 34; 308    | YT-3952 | 164        | YT-4177 | 166        | YT-4402 | 170        | YT-4563  | 147        | YT-47151 | 151        | YT-4874  | 8          |
| YT-3770 | 72         | YT-3853  | 34         | YT-3954 | 164        | YT-4178 | 166        | YT-4403 | 170        | YT-4564  | 147        | YT-47152 | 151        | YT-4875  | 8          |
| YT-3771 | 72         | YT-3854  | 34         | YT-3955 | 164        | YT-4179 | 166        | YT-4430 | 163        | YT-4570  | 147        | YT-4720  | 169        | YT-4876  | 8          |
| YT-3772 | 72         | YT-3855  | 46         | YT-3957 | 164        | YT-4180 | 166        | YT-4431 | 163        | YT-4571  | 147        | YT-4721  | 169        | YT-4877  | 8          |
| YT-3773 | 72         | YT-3856  | 47         | YT-3958 | 164        | YT-4181 | 166        | YT-4432 | 163        | YT-4573  | 147        | YT-4722  | 169        | YT-4878  | 8          |
| YT-3774 | 72         | YT-3857  | 47         | YT-3959 | 164        | YT-4182 | 166        | YT-4433 | 163        | YT-4574  | 147        | YT-4723  | 169        | YT-4879  | 8          |
| YT-3775 | 72         | YT-3861  | 46         | YT-3970 | 164        | YT-4183 | 166        | YT-4434 | 163        | YT-4590  | 149        | YT-4730  | 153        | YT-4880  | 8          |
| YT-3776 | 72         | YT-3863  | 46         | YT-3971 | 164        | YT-4184 | 166        | YT-4435 | 163        | YT-4594  | 148        | YT-4750  | 191        | YT-4881  | 8          |
| YT-3777 | 72         | YT-38631 | 46         | YT-3973 | 164        | YT-4185 | 166        | YT-4436 | 163        | YT-4600  | 148        | YT-4751  | 191        | YT-4882  | 8          |
| YT-3778 | 72         | YT-3864  | 46         | YT-3976 | 164        | YT-4186 | 166        | YT-4437 | 163        | YT-4601  | 148        | YT-4752  | 191        | YT-4883  | 8          |
| YT-3779 | 72         | YT-38641 | 46         | YT-3978 | 164        | YT-4187 | 166        | YT-4438 | 163        | YT-4602  | 148        | YT-4755  | 191        | YT-4884  | 8          |
| YT-3780 | 72         | YT-3865  | 64         | YT-3980 | 164        | YT-4188 | 166        | YT-4439 | 163        | YT-4603  | 148        | YT-4757  | 191        | YT-4885  | 8          |
| YT-3781 | 72         | YT-3867  | 50         | YT-3982 | 164        | YT-4189 | 166        | YT-4440 | 163        | YT-4604  | 148        | YT-4758  | 191        | YT-48851 | 8          |
| YT-3782 | 72         | YT-3868  | 48         | YT-3984 | 164        | YT-4190 | 166        | YT-4441 | 163        | YT-4605  | 148        | YT-4759  | 191        | YT-4901  | 9          |
| YT-3783 | 72         | YT-3869  | 51         | YT-3986 | 164        | YT-4191 | 166        | YT-4442 | 163        | YT-4620  | 148        | YT-4761  | 191        | YT-4902  | 9          |
| YT-3784 | 72         | YT-3870  | 50         | YT-3988 | 164        | YT-4192 | 166        | YT-4443 | 163        | YT-4622  | 148        | YT-4763  | 191        | YT-4903  | 9          |
| YT-3785 | 72         | YT-3871  | 52         | YT-3989 | 164        | YT-4200 | 165        | YT-4444 | 163        | YT-4623  | 148        | YT-4764  | 191        | YT-4904  | 9          |
| YT-3786 | 72         | YT-3872  | 51         | YT-3990 | 164        | YT-4201 | 165        | YT-4445 | 163        | YT-4624  | 148        | YT-4766  | 191        | YT-4905  | 9          |
| YT-3787 | 72         | YT-3873  | 51         | YT-3992 | 164        | YT-4202 | 165        | YT-4446 | 163        | YT-4625  | 148        | YT-4767  | 191        | YT-4906  | 9          |
| YT-3788 | 72         | YT-3874  | 52         | YT-3993 | 164        | YT-4203 | 165        | YT-4447 | 163        | YT-4626  | 148        | YT-4768  | 191        | YT-4907  | 9          |
| YT-3790 | 72         | YT-3875  | 52         | YT-3994 | 164        | YT-4204 | 165        | YT-4448 | 163        | YT-4630  | 148        | YT-4769  | 191        | YT-4908  | 9          |
| YT-3791 | 72         | YT-3876  | 53         | YT-3996 | 164        | YT-4205 | 165        | YT-4449 | 163        | YT-4631  | 148        | YT-4800  | 12         | YT-4909  | 9          |
| YT-3792 | 72         | YT-3877  | 53         | YT-3997 | 164        | YT-4206 | 165        | YT-4450 | 163        | YT-4632  | 148        | YT-4801  | 12         | YT-4910  | 9          |
| YT-3793 | 72         | YT-3878  | 54         | YT-3998 | 164        | YT-4207 | 165        | YT-4451 | 163        | YT-4633  | 148        | YT-4802  | 12         | YT-4911  | 9          |
| YT-3794 | 72         | YT-3879  | 56         | YT-3999 | 164        | YT-4208 | 165        | YT-4452 | 163        | YT-4634  | 148        | YT-4803  | 12         | YT-4912  | 9          |
| YT-3795 | 72         | YT-3880  | 58         | YT-4000 | 164        | YT-4209 | 165        | YT-4453 | 163        | YT-4635  | 148        | YT-4804  | 12         | YT-4915  | 22         |
| YT-3801 | 33         | YT-3881  | 60         | YT-4001 | 164        | YT-4210 | 165        | YT-4454 | 163        | YT-4636  | 148        | YT-4805  | 12         | YT-4916  | 22         |
| YT-3802 | 33         | YT-3882  | 48         | YT-4003 | 164        | YT-4211 | 165        | YT-4455 | 163        | YT-4637  | 148        | YT-4806  | 12         | YT-4917  | 22         |
| YT-3803 | 33         | YT-3883  | 58         | YT-4005 | 164        | YT-4212 | 165        | YT-4456 | 163        | YT-4638  | 148        | YT-4807  | 12         | YT-4918  | 22         |
| YT-3804 | 33         | YT-3884  | 61         | YT-4007 | 164        | YT-4213 | 165        | YT-4457 | 163        | YT-4639  | 148        | YT-4808  | 12         | YT-4919  | 22         |
| YT-3805 | 33         | YT-3886  | 48         | YT-4008 | 164        | YT-4214 | 165        | YT-4458 | 163        | YT-4640  | 148        | YT-4809  | 12         | YT-4920  | 22         |
| YT-3806 | 33         | YT-3887  | 59         | YT-4009 | 164        | YT-4215 | 165        | YT-4460 | 163        | YT-4641  | 148        | YT-4810  | 12         | YT-4921  | 22         |
| YT-3807 | 33         | YT-3888  | 59         | YT-4010 | 165        | YT-4216 | 165        | YT-4461 | 163        | YT-4642  | 148        | YT-4811  | 12         | YT-4922  | 22         |
| YT-3808 | 33         | YT-3889  | 57         | YT-4015 | 165        | YT-4217 | 165        | YT-4462 | 163        | YT-4643  | 148        | YT-4812  | 12         | YT-4923  | 22         |
| YT-3809 | 33         | YT-3890  | 57         | YT-4020 | 165        | YT-4218 | 165        | YT-4491 | 146        | YT-4644  | 148        | YT-4813  | 12         | YT-4924  | 22         |
| YT-3810 | 33         | YT-3891  | 54         | YT-4025 | 165        | YT-4219 | 165        | YT-4492 | 146        | YT-46800 | 153        | YT-4814  | 12         | YT-4925  | 22         |
| YT-3811 | 33         | YT-3892  | 55         | YT-4030 | 165        | YT-4220 | 165        | YT-4493 | 146        | YT-46801 | 153        | YT-4815  | 12         | YT-4926  | 22         |
| YT-3812 | 33         | YT-3893  | 60         | YT-4032 | 165        | YT-4221 | 165        | YT-4494 | 146        | YT-46802 | 153        | YT-4816  | 12         | YT-4927  | 22         |
| YT-3813 | 33         | YT-3894  | 61         | YT-4035 | 165        | YT-4222 | 165        | YT-4495 | 146        | YT-46803 | 153        | YT-4817  | 12         | YT-4928  | 22         |
| YT-3814 | 33         | YT-3895  | 274        | YT-4040 | 165        | YT-4223 | 165        | YT-4496 | 146        | YT-46804 | 153        | YT-4830  | 13         | YT-4937  | 22         |
| YT-3815 | 33         | YT-38951 | 275        | YT-4042 | 165        | YT-4224 | 165        | YT-4497 | 146        | YT-46810 | 153        | YT-4831  | 13         | YT-4945  | 22         |
| YT-3816 | 33         | YT-3900  | 164        | YT-4045 | 165        | YT-4225 | 165        | YT-4498 | 146        | YT-46811 | 153        | YT-4832  | 13         | YT-4950  | 21         |
| YT-3817 | 33         | YT-39002 | 62         | YT-4048 | 165        | YT-4226 | 165        | YT-4499 | 146        | YT-46812 | 153        | YT-4833  | 13         | YT-4951  | 21         |
| YT-3818 | 33         | YT-39003 | 62         | YT-4050 | 165        | YT-4227 | 165        | YT-4500 | 146        | YT-46813 | 153        | YT-4834  | 13         | YT-4952  | 21         |
| YT-3819 | 33         | YT-39005 | 62         | YT-4052 | 165        | YT-4228 | 165        | YT-4501 | 146        | YT-46814 | 153        | YT-4835  | 13         | YT-4953  | 21         |
| YT-3820 | 33         | YT-39006 | 62         | YT-4055 | 165        | YT-4229 | 165        | YT-4502 | 146        | YT-46820 | 153        | YT-4836  | 13         | YT-4954  | 21         |
| YT-3821 | 33         | YT-39007 | 62         | YT-4060 | 165        | YT-4230 | 165        | YT-4503 | 146        | YT-46821 | 153        | YT-4837  | 13         | YT-4955  | 21         |
| YT-3822 | 33         | YT-39008 | 62         | YT-4065 | 165        | YT-4235 | 168        | YT-4504 | 146        | YT-46822 | 153        | YT-48371 | 13         | YT-4956  | 21         |
| YT-3823 | 33         | YT-3903  | 164        | YT-4070 | 165        | YT-4351 | 168        | YT-4505 | 146        | YT-46823 | 153        | YT-4840  | 14         | YT-4957  | 21         |
| YT-3824 | 33         | YT-3904  | 63         | YT-4075 | 165        | YT-4352 | 168        | YT-4506 | 146        | YT-4690  | 152        | YT-4841  | 14         | YT-4960  | 21         |
| YT-3825 | 33         | YT-3905  | 164        | YT-4080 | 165        | YT-4353 | 168        | YT-4507 | 146        | YT-4691  | 152        | YT-4842  | 14         | YT-4961  | 21         |
| YT-3826 | 33         | YT-3906  | 63         | YT-4085 | 165        | YT-4354 | 168        | YT-4508 | 146        | YT-4692  | 152        | YT-4843  | 14         | YT-4962  | 21         |
| YT-3827 | 33         | YT-3908  | 63         | YT-4090 | 165        | YT-4355 | 168        | YT-4509 | 146        | YT-4693  | 152        | YT-4844  | 14         | YT-4963  | 21         |
| YT-3828 | 33         | YT-3909  | 63         | YT-4100 | 165        | YT-4356 | 168        | YT-4510 | 146        | YT-4694  | 152        | YT-4845  | 14         | YT-4964  | 21         |
| YT-3829 | 33         | YT-3910  | 164        | YT-4110 | 165        | YT-4357 | 168        | YT-4515 | 149        | YT-4695  | 152        | YT-4846  | 14         | YT-4965  | 21         |
| YT-3830 | 33         | YT-3913  | 164        | YT-4120 | 165        | YT-4358 | 168        | YT-4516 | 149        | YT-4700  | 150        | YT-4847  | 14         | YT-4966  | 21         |
| YT-3831 | 33         | YT-3914  | 164        | YT-4140 | 165        | YT-4359 | 168        | YT-4517 | 149        | YT-4701  | 150        | YT-4848  | 14         | YT-4967  | 21         |
| YT-3832 | 33         | YT-3916  | 164        | YT-4160 | 165        | YT-4361 | 166        | YT-4518 | 149        | YT-4705  | 150        | YT-4849  | 14         | YT-5000  | 8          |
| YT-3833 | 33         | YT-3919  | 164        | YT-4161 | 166        | YT-4362 | 166        | YT-4519 | 149        | YT-4710  | 150        | YT-4850  | 14         | YT-5001  | 8          |
| YT-3834 | 33         | YT-3922  | 164        | YT-4162 | 166        | YT-4363 | 166        | YT-4520 | 149        | YT-4711  | 151        | YT-4851  | 14         | YT-5002  | 8          |



| YATO     | page/strona | YATO    | page/strona | YATO     | page/strona | YATO    | page/strona | YATO    | page/strona   | YATO     | page/strona | YATO     | page/strona | YATO    | page/strona |
|----------|-------------|---------|-------------|----------|-------------|---------|-------------|---------|---------------|----------|-------------|----------|-------------|---------|-------------|
| YT-5003  | 8           | YT-5083 | 37          | YT-5407  | 239         | YT-5746 | 107         | YT-5831 | 108           | YT-5945  | 178         | YT-6093  | 178         | YT-6188 | 199         |
| YT-5004  | 8           | YT-5084 | 37          | YT-5408  | 239         | YT-5747 | 107         | YT-5832 | 108           | YT-5946  | 179         | YT-6095  | 178         | YT-6189 | 199         |
| YT-5005  | 8           | YT-5085 | 37          | YT-5410  | 239         | YT-5748 | 107         | YT-5833 | 108           | YT-5947  | 179         | YT-6097  | 178         | YT-6190 | 199         |
| YT-5006  | 8           | YT-5086 | 37          | YT-5415  | 238         | YT-5749 | 107         | YT-5835 | 108           | YT-5948  | 179         | YT-6099  | 178         | YT-6191 | 199         |
| YT-5007  | 8           | YT-5087 | 37          | YT-5416  | 238         | YT-5750 | 107         | YT-5836 | 108           | YT-5949  | 179         | YT-61009 | 178         | YT-6192 | 199         |
| YT-5008  | 8           | YT-5088 | 37          | YT-5417  | 238         | YT-5751 | 107         | YT-5837 | 109           | YT-5953  | 176         | YT-6101  | 178         | YT-6193 | 199         |
| YT-5009  | 8           | YT-5089 | 37          | YT-5481  | 242         | YT-5752 | 107         | YT-5838 | 109           | YT-5954  | 176         | YT-6102  | 178         | YT-6194 | 199         |
| YT-5010  | 8           | YT-5090 | 37          | YT-5482  | 242         | YT-5753 | 107         | YT-5840 | 107           | YT-5955  | 176         | YT-6103  | 178         | YT-6219 | 202         |
| YT-5011  | 8           | YT-5091 | 37          | YT-5483  | 242         | YT-5754 | 107         | YT-5841 | 107           | YT-5956  | 176         | YT-6104  | 178         | YT-6220 | 202         |
| YT-5012  | 8           | YT-5092 | 37          | YT-5490  | 242         | YT-5755 | 107         | YT-5842 | 107           | YT-5963  | 176         | YT-6105  | 178         | YT-6221 | 202         |
| YT-5013  | 8           | YT-5093 | 37          | YT-5491  | 242         | YT-5756 | 107         | YT-5843 | 107           | YT-5964  | 176         | YT-6106  | 178         | YT-6222 | 202         |
| YT-5014  | 8           | YT-5094 | 38          | YT-5492  | 242         | YT-5760 | 107         | YT-5844 | 107           | YT-5965  | 176         | YT-6107  | 178         | YT-6223 | 199         |
| YT-5015  | 8           | YT-5095 | 38          | YT-5493  | 242         | YT-5761 | 107         | YT-5845 | 107           | YT-5966  | 176         | YT-6108  | 178         | YT-6224 | 199         |
| YT-5016  | 8           | YT-5096 | 38          | YT-5494  | 242         | YT-5762 | 107         | YT-5846 | 107           | YT-5973  | 177         | YT-61091 | 178         | YT-6225 | 199         |
| YT-5017  | 8           | YT-5097 | 38          | YT-5495  | 242         | YT-5763 | 107         | YT-5847 | 107           | YT-5974  | 177         | YT-6110  | 178         | YT-6226 | 199         |
| YT-5018  | 8           | YT-5098 | 38          | YT-5496  | 242         | YT-5764 | 107         | YT-5848 | 107           | YT-5975  | 177         | YT-6111  | 178         | YT-6227 | 199         |
| YT-5019  | 8           | YT-5099 | 38          | YT-5497  | 242         | YT-5765 | 107         | YT-5849 | 107           | YT-5982  | 177         | YT-6112  | 178         | YT-6228 | 199         |
| YT-5020  | 8           | YT-5100 | 38          | YT-5499  | 242         | YT-5766 | 107         | YT-5851 | 107           | YT-5983  | 177         | YT-6113  | 178         | YT-6229 | 199         |
| YT-5021  | 8           | YT-5101 | 38          | YT-5500  | 242         | YT-5767 | 107         | YT-5852 | 107           | YT-5984  | 177         | YT-6114  | 179         | YT-6230 | 199         |
| YT-5022  | 8           | YT-5102 | 38          | YT-5501  | 242         | YT-5768 | 107         | YT-5853 | 107           | YT-5991  | 177         | YT-6115  | 179         | YT-6231 | 199         |
| YT-5023  | 8           | YT-5103 | 38          | YT-5502  | 242         | YT-5769 | 107         | YT-5854 | 107           | YT-5992  | 177         | YT-6116  | 179         | YT-6232 | 199         |
| YT-5024  | 8           | YT-5104 | 38          | YT-5503  | 242         | YT-5770 | 107         | YT-5855 | 107           | YT-5994  | 177         | YT-6117  | 179         | YT-6233 | 199         |
| YT-5025  | 8           | YT-5105 | 38          | YT-5504  | 242         | YT-5771 | 107         | YT-5856 | 107           | YT-60009 | 176         | YT-6119  | 179         | YT-6234 | 199         |
| YT-5030  | 14          | YT-5106 | 38          | YT-5505  | 242         | YT-5772 | 107         | YT-5857 | 107           | YT-6002  | 176         | YT-6120  | 179         | YT-6235 | 199         |
| YT-50305 | 14          | YT-5107 | 38          | YT-5506  | 242         | YT-5773 | 107         | YT-5858 | 107           | YT-6003  | 176         | YT-6121  | 179         | YT-6236 | 199         |
| YT-5031  | 14          | YT-5130 | 129         | YT-5507  | 242         | YT-5774 | 107         | YT-5859 | 107           | YT-6004  | 176         | YT-6122  | 178         | YT-6237 | 199         |
| YT-5032  | 14          | YT-5131 | 129         | YT-5508  | 242         | YT-5775 | 107         | YT-5860 | 107           | YT-6005  | 176         | YT-6123  | 179         | YT-6238 | 199         |
| YT-5033  | 14          | YT-5140 | 129         | YT-5530  | 269         | YT-5776 | 107         | YT-5861 | 107           | YT-6011  | 176         | YT-6124  | 179         | YT-6239 | 199         |
| YT-5034  | 14          | YT-5141 | 129         | YT-5531  | 271         | YT-5777 | 107         | YT-5862 | 107           | YT-6012  | 176         | YT-6125  | 179         | YT-6241 | 150         |
| YT-5035  | 14          | YT-5142 | 129         | YT-55311 | 273         | YT-5778 | 107         | YT-5863 | 108           | YT-6013  | 176         | YT-6126  | 179         | YT-6242 | 150         |
| YT-5038  | 14          | YT-5200 | 234         | YT-5532  | 271         | YT-5779 | 107         | YT-5865 | 108           | YT-6014  | 176         | YT-6127  | 179         | YT-6243 | 150         |
| YT-5040  | 29          | YT-5202 | 234         | YT-55321 | 273         | YT-5780 | 107         | YT-5866 | 108           | YT-6015  | 176         | YT-6128  | 179         | YT-6244 | 150         |
| YT-5041  | 29          | YT-5203 | 234         | YT-5533  | 271         | YT-5781 | 107         | YT-5867 | 108           | YT-6016  | 176         | YT-6129  | 179         | YT-6245 | 150         |
| YT-5042  | 29          | YT-5204 | 234         | YT-55331 | 273         | YT-5785 | 108         | YT-5868 | 108           | YT-6017  | 176         | YT-6130  | 179         | YT-6246 | 150         |
| YT-5043  | 29          | YT-5207 | 234         | YT-5534  | 271         | YT-5786 | 108         | YT-5869 | 108           | YT-6022  | 176         | YT-6131  | 179         | YT-6247 | 150         |
| YT-5044  | 29          | YT-5209 | 234         | YT-55341 | 273         | YT-5787 | 108         | YT-5870 | 108           | YT-6023  | 176         | YT-6132  | 179         | YT-6248 | 150         |
| YT-5045  | 29          | YT-5210 | 234         | YT-5535  | 272         | YT-5788 | 108         | YT-5871 | 108           | YT-6024  | 176         | YT-6133  | 179         | YT-6249 | 150         |
| YT-5046  | 29          | YT-5212 | 234         | YT-55351 | 273         | YT-5789 | 108         | YT-5872 | 108           | YT-6025  | 176         | YT-6134  | 179         | YT-6251 | 150         |
| YT-5047  | 29          | YT-5214 | 234         | YT-5536  | 272         | YT-5790 | 108         | YT-5873 | 108           | YT-6030  | 177         | YT-6135  | 179         | YT-6253 | 150         |
| YT-5048  | 29          | YT-5216 | 234         | YT-55361 | 273         | YT-5791 | 108         | YT-5875 | 109           | YT-6031  | 177         | YT-6136  | 178         | YT-6256 | 150         |
| YT-5049  | 29          | YT-5218 | 234         | YT-5537  | 272         | YT-5792 | 108         | YT-5877 | 109           | YT-6032  | 177         | YT-6137  | 178         | YT-6258 | 150         |
| YT-5050  | 29          | YT-5221 | 235         | YT-55371 | 273         | YT-5793 | 108         | YT-5878 | 109           | YT-6033  | 177         | YT-6138  | 179         | YT-6260 | 150         |
| YT-5051  | 29          | YT-5226 | 234         | YT-5538  | 272         | YT-5794 | 108         | YT-5890 | 331           | YT-6045  | 177         | YT-6139  | 179         | YT-6280 | 150         |
| YT-5052  | 29          | YT-5228 | 234         | YT-55381 | 273         | YT-5795 | 108         | YT-5892 | 331           | YT-6046  | 177         | YT-6140  | 200         | YT-6281 | 150         |
| YT-5053  | 29          | YT-5230 | 234         | YT-5539  | 272         | YT-5796 | 108         | YT-5893 | 331           | YT-6050  | 178         | YT-6141  | 200         | YT-6328 | 188         |
| YT-5054  | 29          | YT-5234 | 236         | YT-55391 | 273         | YT-5797 | 108         | YT-5894 | 331           | YT-6052  | 178         | YT-6142  | 200         | YT-6329 | 188         |
| YT-5055  | 29          | YT-5237 | 236         | YT-5540  | 272         | YT-5798 | 108         | YT-5901 | 240: 331; 336 | YT-6053  | 178         | YT-6143  | 200         | YT-6330 | 189         |
| YT-5056  | 29          | YT-5240 | 236         | YT-55401 | 273         | YT-5799 | 108         | YT-5902 | 240: 331; 336 | YT-6055  | 178         | YT-6144  | 201         | YT-6331 | 189         |
| YT-5057  | 29          | YT-5242 | 236         | YT-5541  | 272         | YT-5800 | 108         | YT-5904 | 240: 331; 336 | YT-6056  | 178         | YT-6145  | 201         | YT-6332 | 189         |
| YT-5058  | 29          | YT-5243 | 236         | YT-55411 | 273         | YT-5801 | 108         | YT-5905 | 240: 331; 336 | YT-6057  | 178         | YT-6146  | 201         | YT-6333 | 189         |
| YT-5059  | 33          | YT-5245 | 236         | YT-5542  | 272         | YT-5802 | 108         | YT-5911 | 331           | YT-6058  | 178         | YT-6147  | 200         | YT-6334 | 189         |
| YT-5060  | 33          | YT-5247 | 236         | YT-55421 | 273         | YT-5803 | 108         | YT-5913 | 331           | YT-6060  | 178         | YT-6148  | 200         | YT-6335 | 189         |
| YT-5061  | 33          | YT-5250 | 233         | YT-5543  | 271         | YT-5804 | 108         | YT-5914 | 331           | YT-6061  | 178         | YT-6149  | 200         | YT-6336 | 189         |
| YT-5062  | 33          | YT-5251 | 233         | YT-5555  | 327         | YT-5805 | 108         | YT-5920 | 178           | YT-6062  | 178         | YT-6150  | 200         | YT-6337 | 189         |
| YT-5063  | 33          | YT-5252 | 233         | YT-5702  | 198         | YT-5806 | 108         | YT-5921 | 178           | YT-6063  | 178         | YT-6151  | 201         | YT-6338 | 189         |
| YT-5064  | 33          | YT-5253 | 233         | YT-5703  | 198         | YT-5807 | 108         | YT-5922 | 178           | YT-6065  | 178         | YT-6152  | 200         | YT-6339 | 189         |
| YT-5065  | 33          | YT-5254 | 233         | YT-5704  | 198         | YT-5808 | 108         | YT-5923 | 178           | YT-6066  | 178         | YT-6153  | 200         | YT-6340 | 189         |
| YT-5066  | 33          | YT-5255 | 233         | YT-5710  | 196         | YT-5809 | 108         | YT-5924 | 178           | YT-6067  | 178         | YT-6154  | 200         | YT-6341 | 189         |
| YT-5067  | 33          | YT-5260 | 233         | YT-5730  | 107         | YT-5810 | 108         | YT-5925 | 178           | YT-6068  | 178         | YT-6155  | 200         | YT-6342 | 190         |
| YT-5068  | 33          | YT-5261 | 233         | YT-5731  | 107         | YT-5811 | 108         | YT-5926 | 178           | YT-6069  | 178         | YT-6156  | 200         | YT-6343 | 190         |
| YT-5069  | 33          | YT-5262 | 233         | YT-5732  | 107         | YT-5812 | 108         | YT-5927 | 178           | YT-6070  | 178         | YT-6160  | 200         | YT-6344 | 190         |
| YT-5070  | 33          | YT-5302 | 235         | YT-5733  | 107         | YT-5813 | 108         | YT-5930 | 179           | YT-6071  | 178         | YT-6161  | 200         | YT-6345 | 190         |
| YT-5071  | 33          | YT-5304 | 235         | YT-5734  | 107         | YT-5814 | 108         | YT-5931 | 179           | YT-6072  | 178         | YT-6162  | 200         | YT-6346 | 190         |
| YT-5072  | 33          | YT-5305 | 235         | YT-5735  | 107         | YT-5820 | 108         | YT-5932 | 179           | YT-6075  | 178         | YT-6163  | 200         | YT-6347 | 190         |
| YT-5073  | 33          | YT-5306 | 235         | YT-5736  | 107         | YT-5821 | 108         | YT-5933 | 179           | YT-6076  | 178         | YT-6164  | 200         | YT-6348 | 190         |
| YT-5074  | 33          | YT-5307 | 235         | YT-5737  | 107         | YT-5822 | 108         | YT-5934 | 179           | YT-6077  | 178         | YT-6165  | 200         | YT-6349 | 190         |
| YT-5075  | 33          | YT-5310 | 235         | YT-5738  | 107         | YT-5823 | 108         | YT-5935 | 179           | YT-6078  | 178         | YT-6180  | 199         | YT-6350 | 190         |
| YT-5076  | 33          | YT-5320 | 208         | YT-5739  | 107         | YT-5824 | 108         | YT-5936 | 179           | YT-6080  | 178         | YT-6181  | 199         | YT-6351 | 190         |
| YT-5077  | 33          | YT-5321 | 208         | YT-5740  | 107         | YT-5825 | 108         | YT-5937 | 179           | YT-6081  | 178         | YT-6182  | 199         | YT-6353 | 188         |
| YT-5078  | 33          | YT-5400 | 238         | YT-5741  | 107         | YT-5826 | 108         | YT-5940 | 178           | YT-6082  | 178         | YT-6183  | 199         | YT-6354 | 188         |
| YT-5079  | 37          | YT-5402 | 238         | YT-5742  | 107         | YT-5827 | 108         | YT-5941 | 178           | YT-6083  | 178         | YT-6184  | 199         | YT-6355 | 188         |
| YT-5080  | 37          | YT-5404 | 238         | YT-5743  | 107         | YT-5828 | 108         | YT-5942 | 178           | YT-6085  | 178         | YT-6185  | 199         | YT-6356 | 188         |
| YT-5081  | 37          | YT-5405 | 238         | YT-5744  | 107         | YT-5829 | 108         | YT-5943 | 178           | YT-6086  | 178         | YT-6186  | 199         | YT-6357 | 188         |
| YT-5082  | 37          | YT-5406 | 239         | YT-5745  | 107         | YT-5830 | 108         | YT-5944 | 178           | YT-6091  | 178         | YT-6187  | 199         | YT-6358 | 188         |

| YATO     | page/strona | YATO    | page/strona | YATO     | page/strona | YATO     | page/strona | YATO     | page/strona | YATO     | page/strona | YATO    | page/strona |          |     |
|----------|-------------|---------|-------------|----------|-------------|----------|-------------|----------|-------------|----------|-------------|---------|-------------|----------|-----|
| YT-6359  | 188         | YT-6605 | 117         | YT-6985  | 342         | YT-7118  | 248         | YT-7366  | 350         | YT-7501  | 194         | YT-7690 | 67          | YT-7812  | 102 |
| YT-6360  | 188         | YT-6606 | 117         | YT-6986  | 342         | YT-71181 | 249         | YT-7367  | 350         | YT-7502  | 195         | YT-7691 | 67          | YT-7813  | 102 |
| YT-6401  | 156         | YT-6607 | 117         | YT-6987  | 342         | YT-71182 | 249         | YT-7368  | 350         | YT-7503  | 195         | YT-7692 | 67          | YT-78130 | 100 |
| YT-6402  | 156         | YT-6608 | 117         | YT-6988  | 342         | YT-71184 | 249         | YT-7369  | 350         | YT-7504  | 195         | YT-7693 | 67          | YT-78131 | 100 |
| YT-6403  | 156         | YT-6609 | 117         | YT-6989  | 342         | YT-71185 | 249         | YT-7371  | 350         | YT-7505  | 195         | YT-7694 | 67          | YT-78132 | 100 |
| YT-6404  | 156         | YT-6610 | 116         | YT-69900 | 343         | YT-71186 | 249         | YT-7374  | 350         | YT-7506  | 195         | YT-7695 | 67          | YT-78133 | 100 |
| YT-6405  | 156         | YT-6611 | 116         | YT-69901 | 343         | YT-71187 | 249         | YT-73744 | 350         | YT-7507  | 195         | YT-7696 | 67          | YT-78134 | 100 |
| YT-6406  | 156         | YT-6612 | 116         | YT-69902 | 343         | YT-71188 | 249         | YT-7376  | 350         | YT-7508  | 195         | YT-7697 | 67          | YT-78135 | 100 |
| YT-6407  | 156         | YT-6613 | 119         | YT-69903 | 343         | YT-71189 | 249         | YT-73760 | 350         | YT-7509  | 195         | YT-7698 | 67          | YT-78136 | 100 |
| YT-6408  | 156         | YT-6614 | 119         | YT-69905 | 343         | YT-7126  | 248         | YT-73761 | 350         | YT-7510  | 194         | YT-7699 | 67          | YT-7814  | 102 |
| YT-6409  | 156         | YT-6615 | 119         | YT-69906 | 343         | YT-7127  | 248         | YT-7377  | 351         | YT-7511  | 195         | YT-7700 | 67          | YT-78141 | 100 |
| YT-6410  | 156         | YT-6616 | 119         | YT-69907 | 343         | YT-7128  | 248         | YT-7380  | 351         | YT-7512  | 195         | YT-7701 | 67          | YT-78142 | 100 |
| YT-6412  | 156         | YT-6617 | 119         | YT-69908 | 343         | YT-7129  | 248         | YT-73801 | 351         | YT-7520  | 194         | YT-7702 | 67          | YT-78143 | 100 |
| YT-6413  | 156         | YT-6618 | 119         | YT-69910 | 343         | YT-7130  | 248         | YT-7381  | 351         | YT-7522  | 194         | YT-7703 | 67          | YT-78144 | 100 |
| YT-6414  | 156         | YT-6619 | 119         | YT-69911 | 343         | YT-7131  | 248         | YT-7382  | 351         | YT-7523  | 194         | YT-7704 | 67          | YT-78145 | 100 |
| YT-6415  | 156         | YT-6620 | 120         | YT-69912 | 343         | YT-7149  | 249         | YT-7383  | 351         | YT-7524  | 195         | YT-7705 | 67          | YT-78146 | 100 |
| YT-6416  | 156         | YT-6621 | 120         | YT-69913 | 343         | YT-7150  | 249         | YT-73830 | 351         | YT-7525  | 195         | YT-7706 | 67          | YT-78147 | 100 |
| YT-6417  | 156         | YT-6622 | 120         | YT-69914 | 343         | YT-7151  | 249         | YT-7400  | 346         | YT-7527  | 195         | YT-7707 | 67          | YT-7815  | 102 |
| YT-6419  | 157         | YT-6623 | 120         | YT-69920 | 343         | YT-7152  | 249         | YT-7405  | 346         | YT-7528  | 195         | YT-7708 | 67          | YT-78150 | 100 |
| YT-6420  | 156         | YT-6624 | 120         | YT-69921 | 343         | YT-7153  | 249         | YT-7409  | 346         | YT-7529  | 195         | YT-7709 | 67          | YT-78151 | 100 |
| YT-6421  | 156         | YT-6625 | 120         | YT-69922 | 343         | YT-7154  | 249         | YT-7410  | 346         | YT-7530  | 195         | YT-7710 | 67          | YT-78152 | 100 |
| YT-6422  | 156         | YT-6626 | 120         | YT-69923 | 343         | YT-71551 | 249         | YT-7413  | 346         | YT-7531  | 195         | YT-7711 | 67          | YT-78153 | 100 |
| YT-6423  | 156         | YT-6628 | 120         | YT-69924 | 343         | YT-71552 | 249         | YT-7414  | 346         | YT-7532  | 194         | YT-7712 | 67          | YT-78154 | 101 |
| YT-6424  | 156         | YT-6629 | 120         | YT-7000  | 221         | YT-71555 | 249         | YT-7416  | 346         | YT-7534  | 194         | YT-7713 | 68          | YT-78155 | 101 |
| YT-6426  | 156         | YT-6630 | 120         | YT-7001  | 221         | YT-71556 | 249         | YT-7417  | 346         | YT-7550  | 198         | YT-7714 | 68          | YT-78156 | 101 |
| YT-64270 | 156         | YT-6631 | 120         | YT-7003  | 221         | YT-71560 | 249         | YT-7419  | 347         | YT-7551  | 198         | YT-7715 | 68          | YT-7816  | 102 |
| YT-64271 | 156         | YT-6700 | 225; 336    | YT-7004  | 221         | YT-71561 | 249         | YT-7420  | 347         | YT-7560  | 196         | YT-7716 | 68          | YT-78160 | 101 |
| YT-64272 | 156         | YT-6705 | 225; 336    | YT-7005  | 221         | YT-71562 | 249         | YT-7430  | 347         | YT-7561  | 196         | YT-7717 | 68          | YT-78161 | 101 |
| YT-64280 | 156         | YT-6706 | 225; 336    | YT-7006  | 221         | YT-71565 | 249         | YT-7433  | 347         | YT-7571  | 194         | YT-7718 | 68          | YT-78162 | 101 |
| YT-64281 | 156         | YT-6740 | 224         | YT-7007  | 221         | YT-71566 | 249         | YT-7434  | 347         | YT-7581  | 194         | YT-7719 | 68          | YT-78163 | 101 |
| YT-64282 | 156         | YT-6741 | 224         | YT-7011  | 221         | YT-71567 | 249         | YT-7435  | 347         | YT-7600  | 192         | YT-7720 | 68          | YT-78164 | 101 |
| YT-64283 | 156         | YT-6742 | 224         | YT-7022  | 221         | YT-7200  | 250         | YT-7440  | 347         | YT-7601  | 192         | YT-7721 | 68          | YT-78165 | 101 |
| YT-64284 | 156         | YT-6743 | 224         | YT-7023  | 221         | YT-7201  | 250         | YT-7446  | 347         | YT-76030 | 193         | YT-7722 | 68          | YT-78166 | 101 |
| YT-64290 | 156         | YT-6744 | 224         | YT-7024  | 221         | YT-7220  | 251         | YT-7450  | 354         | YT-76031 | 192         | YT-7723 | 68          | YT-78167 | 101 |
| YT-64291 | 156         | YT-6745 | 224         | YT-7025  | 221         | YT-7221  | 251         | YT-7451  | 354         | YT-76040 | 193         | YT-7724 | 68          | YT-7817  | 102 |
| YT-64292 | 156         | YT-6750 | 225         | YT-7026  | 221         | YT-7222  | 251         | YT-74510 | 354         | YT-76041 | 193         | YT-7725 | 68          | YT-7818  | 102 |
| YT-64293 | 156         | YT-6751 | 224         | YT-7032  | 221         | YT-7223  | 251         | YT-7452  | 354         | YT-76042 | 193         | YT-7726 | 68          | YT-7819  | 102 |
| YT-64294 | 156         | YT-6752 | 224         | YT-7033  | 221         | YT-7290  | 317         | YT-7453  | 354         | YT-76043 | 193         | YT-7727 | 68          | YT-78190 | 101 |
| YT-64295 | 156         | YT-6753 | 224         | YT-7034  | 221         | YT-7291  | 317         | YT-7454  | 354         | YT-76050 | 192         | YT-7728 | 68          | YT-78191 | 101 |
| YT-6440  | 156         | YT-6754 | 224         | YT-7050  | 221         | YT-7292  | 318         | YT-7455  | 354         | YT-76051 | 192         | YT-7729 | 68          | YT-78192 | 101 |
| YT-6441  | 156         | YT-6755 | 225         | YT-7051  | 221         | YT-7293  | 318         | YT-7456  | 354         | YT-76052 | 192         | YT-7730 | 68          | YT-78193 | 101 |
| YT-6442  | 156         | YT-6756 | 225         | YT-7052  | 221         | YT-7294  | 318         | YT-7458  | 354         | YT-7620  | 240         | YT-7731 | 68          | YT-78194 | 101 |
| YT-6443  | 156         | YT-6757 | 225         | YT-7053  | 221         | YT-7295  | 318         | YT-7459  | 354         | YT-7623  | 240         | YT-7732 | 68          | YT-7820  | 102 |
| YT-6444  | 156         | YT-6801 | 175         | YT-7054  | 221         | YT-7296  | 318         | YT-7460  | 352         | YT-7624  | 240         | YT-7733 | 68          | YT-7821  | 102 |
| YT-6445  | 156         | YT-6803 | 175         | YT-7055  | 221         | YT-7297  | 318         | YT-7461  | 352         | YT-7660  | 67          | YT-7734 | 68          | YT-7822  | 102 |
| YT-6446  | 156         | YT-6854 | 323         | YT-7070  | 250         | YT-7298  | 318         | YT-7462  | 354         | YT-7661  | 67          | YT-7735 | 68          | YT-7823  | 102 |
| YT-6447  | 156         | YT-6855 | 323         | YT-7071  | 250         | YT-7300  | 304         | YT-74621 | 354         | YT-7662  | 67          | YT-7736 | 68          | YT-7824  | 102 |
| YT-6448  | 156         | YT-6862 | 323         | YT-7080  | 250         | YT-7301  | 304         | YT-7463  | 354         | YT-7663  | 67          | YT-7737 | 68          | YT-7825  | 102 |
| YT-6449  | 156         | YT-6863 | 323         | YT-7081  | 250         | YT-7302  | 304         | YT-7464  | 352         | YT-7664  | 67          | YT-7738 | 68          | YT-7826  | 102 |
| YT-6450  | 156         | YT-6903 | 131; 320    | YT-7082  | 250         | YT-7306  | 304         | YT-7465  | 352         | YT-7665  | 67          | YT-7739 | 68          | YT-7827  | 102 |
| YT-6451  | 156         | YT-6907 | 131; 320    | YT-7083  | 250         | YT-7307  | 303         | YT-7466  | 352         | YT-7666  | 67          | YT-7740 | 68          | YT-7828  | 102 |
| YT-6452  | 156         | YT-6909 | 131; 320    | YT-7084  | 250         | YT-73080 | 142; 247    | YT-7467  | 352         | YT-7667  | 67          | YT-7741 | 68          | YT-7829  | 102 |
| YT-6453  | 156         | YT-6910 | 131; 320    | YT-7090  | 250         | YT-73082 | 142; 247    | YT-7468  | 352         | YT-7668  | 67          | YT-7742 | 68          | YT-7830  | 102 |
| YT-6454  | 156         | YT-6912 | 131; 320    | YT-7091  | 250         | YT-73084 | 142; 247    | YT-7469  | 352         | YT-7669  | 67          | YT-7743 | 68          | YT-7831  | 102 |
| YT-6501  | 157         | YT-6913 | 131; 320    | YT-7103  | 248         | YT-73086 | 142; 247    | YT-7470  | 351         | YT-7670  | 67          | YT-7744 | 68          | YT-7832  | 102 |
| YT-6502  | 157         | YT-6916 | 131; 320    | YT-7105  | 248         | YT-73087 | 142; 247    | YT-7471  | 352         | YT-7671  | 67          | YT-7745 | 68          | YT-7833  | 102 |
| YT-6503  | 157         | YT-6917 | 131; 320    | YT-7110  | 248         | YT-73088 | 142; 247    | YT-7472  | 351         | YT-7672  | 67          | YT-7746 | 68          | YT-7834  | 102 |
| YT-6504  | 157         | YT-6918 | 131; 320    | YT-7111  | 248         | YT-73091 | 142; 247    | YT-7473  | 351         | YT-7673  | 67          | YT-7747 | 68          | YT-7840  | 102 |
| YT-6505  | 157         | YT-6920 | 131; 320    | YT-7112  | 248         | YT-7310  | 306         | YT-7474  | 351         | YT-7674  | 67          | YT-7750 | 69          | YT-7841  | 102 |
| YT-6506  | 157         | YT-6925 | 242         | YT-71130 | 248         | YT-7311  | 306         | YT-7476  | 352         | YT-7675  | 67          | YT-7751 | 69          | YT-7842  | 102 |
| YT-6510  | 157         | YT-6926 | 242         | YT-71131 | 248         | YT-7312  | 306         | YT-7477  | 352         | YT-7676  | 67          | YT-7752 | 69          | YT-7843  | 102 |
| YT-6511  | 157         | YT-6927 | 242         | YT-71133 | 248         | YT-7320  | 296         | YT-7480  | 352         | YT-7677  | 67          | YT-7753 | 69          | YT-7844  | 102 |
| YT-6512  | 157         | YT-6960 | 342         | YT-71135 | 248         | YT-7349  | 324         | YT-7481  | 352         | YT-7678  | 67          | YT-7800 | 102         | YT-7845  | 102 |
| YT-6513  | 157         | YT-6961 | 342         | YT-71136 | 248         | YT-7350  | 324         | YT-7485  | 353         | YT-7679  | 67          | YT-7801 | 102         | YT-7846  | 102 |
| YT-6581  | 117         | YT-6962 | 342         | YT-71138 | 248         | YT-7351  | 324         | YT-7486  | 353         | YT-7680  | 67          | YT-7802 | 102         | YT-7847  | 102 |
| YT-6582  | 117         | YT-6963 | 342         | YT-71140 | 248         | YT-7352  | 324         | YT-7487  | 353         | YT-7681  | 67          | YT-7803 | 102         | YT-7848  | 102 |
| YT-6583  | 117         | YT-6964 | 342         | YT-71141 | 248         | YT-7360  | 350         | YT-7488  | 353         | YT-7682  | 67          | YT-7804 | 102         | YT-7849  | 102 |
| YT-6586  | 117         | YT-6965 | 342         | YT-71142 | 248         | YT-7361  | 350         | YT-7489  | 353         | YT-7683  | 67          | YT-7805 | 102         | YT-7850  | 102 |
| YT-6587  | 117         | YT-6966 | 342         | YT-71143 | 248         | YT-7362  | 350         | YT-7490  | 353         | YT-7684  | 67          | YT-7806 | 102         | YT-7851  | 102 |
| YT-6600  | 116         | YT-6980 | 342         | YT-71144 | 248         | YT-7363  | 350         | YT-7491  | 353         | YT-7685  | 67          | YT-7807 | 102         | YT-7852  | 102 |
| YT-6601  | 116         | YT-6981 | 342         | YT-71145 | 248         | YT-73631 | 350         | YT-7492  | 353         | YT-7686  | 67          | YT-7808 | 102         | YT-7853  | 102 |
| YT-6602  | 116         | YT-6982 | 342         | YT-71146 | 248         | YT-7364  | 350         | YT-7493  | 353         | YT-7687  | 67          | YT-7809 | 102         | YT-7854  | 102 |
| YT-6603  | 116         | YT-6983 | 342         | YT-7116  | 248         | YT-73641 | 350         | YT-7494  | 353         | YT-7688  | 67          | YT-7810 | 102         | YT-7855  | 102 |
| YT-6604  | 116         | YT-6984 | 342         | YT-7117  | 248         | YT-7365  | 350         | YT-7500  | 194         | YT-7689  | 67          | YT-7811 | 102         | YT-7856  | 102 |

| YATO    | page/strona | YATO     | page/strona | YATO     | page/strona | YATO     | page/strona | YATO     | page/strona | YATO     | page/strona | YATO     | page/strona | YATO     | page/strona |
|---------|-------------|----------|-------------|----------|-------------|----------|-------------|----------|-------------|----------|-------------|----------|-------------|----------|-------------|
| YT-7857 | 102         | YT-7941  | 103         | YT-80573 | 355         | YT-80844 | 356         | YT-8304  | 329         | YT-83271 | 206         | YT-83398 | 207         | YT-8367  | 203         |
| YT-7858 | 102         | YT-7942  | 103         | YT-80574 | 355         | YT-80845 | 356         | YT-8305  | 329         | YT-83272 | 206         | YT-83399 | 207         | YT-8368  | 203         |
| YT-7859 | 102         | YT-7943  | 103         | YT-80575 | 355         | YT-80846 | 356         | YT-83051 | 329         | YT-83273 | 206         | YT-83400 | 207         | YT-8370  | 203         |
| YT-7860 | 102         | YT-7944  | 103         | YT-80576 | 355         | YT-80847 | 356         | YT-83052 | 329         | YT-83274 | 206         | YT-83401 | 207         | YT-8371  | 203         |
| YT-7861 | 102         | YT-7945  | 103         | YT-80577 | 355         | YT-80848 | 356         | YT-83060 | 329         | YT-83275 | 206         | YT-83420 | 208         | YT-8372  | 203         |
| YT-7862 | 102         | YT-7946  | 103         | YT-80578 | 355         | YT-80849 | 356         | YT-83061 | 329         | YT-83276 | 206         | YT-83421 | 208         | YT-8373  | 203         |
| YT-7863 | 102         | YT-7947  | 103         | YT-80579 | 355         | YT-8100  | 241; 360    | YT-83062 | 329         | YT-83281 | 206         | YT-83422 | 208         | YT-8374  | 203         |
| YT-7864 | 102         | YT-7948  | 103         | YT-80580 | 355         | YT-8101  | 241; 360    | YT-8310  | 246; 330    | YT-83282 | 206         | YT-83423 | 208         | YT-8375  | 203         |
| YT-7865 | 102         | YT-7949  | 103         | YT-80583 | 355         | YT-8102  | 241; 360    | YT-83101 | 246; 330    | YT-83283 | 206         | YT-83424 | 208         | YT-8376  | 203         |
| YT-7866 | 102         | YT-7950  | 103         | YT-80584 | 355         | YT-8104  | 241; 360    | YT-8311  | 246; 330    | YT-83284 | 206         | YT-83425 | 208         | YT-8377  | 203         |
| YT-7867 | 102         | YT-7951  | 103         | YT-80585 | 355         | YT-8106  | 241; 360    | YT-83150 | 330         | YT-83285 | 206         | YT-83426 | 208         | YT-8378  | 203         |
| YT-7868 | 102         | YT-7952  | 103         | YT-80586 | 355         | YT-8107  | 241; 360    | YT-83151 | 330         | YT-83286 | 206         | YT-83427 | 208         | YT-8400  | 204         |
| YT-7869 | 102         | YT-7953  | 103         | YT-80587 | 355         | YT-8108  | 241; 360    | YT-83152 | 330         | YT-83291 | 206         | YT-83428 | 208         | YT-8401  | 204         |
| YT-7870 | 102         | YT-7954  | 103         | YT-80588 | 355         | YT-8110  | 241; 360    | YT-83153 | 330         | YT-83292 | 206         | YT-83430 | 208         | YT-8402  | 204         |
| YT-7871 | 102         | YT-7955  | 103         | YT-80589 | 355         | YT-8111  | 241; 360    | YT-83160 | 205         | YT-83293 | 206         | YT-83431 | 208         | YT-8403  | 204         |
| YT-7872 | 102         | YT-7956  | 103         | YT-80590 | 355         | YT-8112  | 241; 360    | YT-83161 | 205         | YT-83294 | 206         | YT-83432 | 208         | YT-8404  | 204         |
| YT-7873 | 102         | YT-7957  | 103         | YT-80591 | 355         | YT-8115  | 241; 360    | YT-83162 | 205         | YT-83295 | 206         | YT-83433 | 208         | YT-8405  | 204         |
| YT-7874 | 102         | YT-7958  | 103         | YT-80761 | 355         | YT-8116  | 241; 360    | YT-83163 | 205         | YT-83296 | 206         | YT-83434 | 208         | YT-8406  | 204         |
| YT-7880 | 102         | YT-7959  | 103         | YT-80762 | 355         | YT-8120  | 241; 360    | YT-83164 | 205         | YT-83301 | 206         | YT-83435 | 208         | YT-8407  | 204         |
| YT-7881 | 102         | YT-7960  | 103         | YT-80763 | 355         | YT-8152  | 143         | YT-83165 | 205         | YT-83302 | 206         | YT-83436 | 208         | YT-8408  | 204         |
| YT-7882 | 102         | YT-7961  | 103         | YT-80764 | 355         | YT-8156  | 143         | YT-83166 | 205         | YT-83303 | 206         | YT-83437 | 208         | YT-8409  | 204         |
| YT-7883 | 102         | YT-7962  | 103         | YT-80765 | 355         | YT-8159  | 143         | YT-83167 | 205         | YT-83304 | 206         | YT-83438 | 208         | YT-8410  | 204         |
| YT-7884 | 102         | YT-7963  | 103         | YT-80766 | 355         | YT-8165  | 143         | YT-83168 | 205         | YT-83305 | 206         | YT-83440 | 208         | YT-8411  | 204         |
| YT-7885 | 102         | YT-7964  | 103         | YT-80767 | 355         | YT-8166  | 143         | YT-83169 | 205         | YT-83306 | 206         | YT-83441 | 208         | YT-8412  | 204         |
| YT-7886 | 102         | YT-7965  | 103         | YT-80768 | 355         | YT-8173  | 143         | YT-83180 | 205         | YT-83311 | 206         | YT-83442 | 208         | YT-8413  | 204         |
| YT-7887 | 102         | YT-7966  | 103         | YT-80769 | 355         | YT-8174  | 143         | YT-83181 | 205         | YT-83312 | 206         | YT-83443 | 208         | YT-8414  | 204         |
| YT-7888 | 102         | YT-7971  | 103         | YT-80772 | 356         | YT-8177  | 143         | YT-83182 | 205         | YT-83313 | 206         | YT-83444 | 208         | YT-8415  | 204         |
| YT-7889 | 102         | YT-7972  | 103         | YT-80773 | 356         | YT-81790 | 361         | YT-83183 | 205         | YT-83314 | 206         | YT-83445 | 208         | YT-8416  | 204         |
| YT-7890 | 102         | YT-7973  | 103         | YT-80774 | 356         | YT-81791 | 361         | YT-83184 | 205         | YT-83315 | 206         | YT-83446 | 208         | YT-8417  | 204         |
| YT-7891 | 103         | YT-7974  | 103         | YT-80775 | 356         | YT-81792 | 361         | YT-83185 | 205         | YT-83316 | 206         | YT-83447 | 208         | YT-8418  | 204         |
| YT-7892 | 103         | YT-7975  | 103         | YT-80776 | 356         | YT-81793 | 361         | YT-83186 | 205         | YT-83321 | 206         | YT-83448 | 208         | YT-8440  | 203         |
| YT-7893 | 103         | YT-7980  | 103         | YT-80777 | 356         | YT-81794 | 361         | YT-83187 | 205         | YT-83322 | 206         | YT-83450 | 208         | YT-8441  | 203         |
| YT-7894 | 103         | YT-8001  | 153         | YT-80778 | 356         | YT-81795 | 361         | YT-83188 | 205         | YT-83323 | 206         | YT-83451 | 208         | YT-8442  | 203         |
| YT-7895 | 103         | YT-8002  | 153         | YT-80779 | 356         | YT-82288 | 334         | YT-83189 | 205         | YT-83324 | 206         | YT-83452 | 208         | YT-8443  | 203         |
| YT-7896 | 103         | YT-8003  | 153         | YT-80780 | 356         | YT-82291 | 334         | YT-83190 | 205         | YT-83325 | 206         | YT-83453 | 208         | YT-8444  | 203         |
| YT-7897 | 103         | YT-8004  | 153         | YT-80783 | 356         | YT-82292 | 334         | YT-83200 | 205         | YT-83326 | 206         | YT-83454 | 208         | YT-8445  | 203         |
| YT-7898 | 103         | YT-8005  | 153         | YT-80784 | 356         | YT-82293 | 334         | YT-83201 | 205         | YT-83331 | 206         | YT-83455 | 208         | YT-8446  | 203         |
| YT-7899 | 103         | YT-8006  | 153         | YT-80785 | 356         | YT-8240  | 227; 338    | YT-83202 | 205         | YT-83332 | 206         | YT-83456 | 208         | YT-8447  | 203         |
| YT-7900 | 103         | YT-8011  | 153         | YT-80786 | 356         | YT-82401 | 227; 338    | YT-83203 | 205         | YT-83333 | 206         | YT-83457 | 208         | YT-8448  | 203         |
| YT-7901 | 103         | YT-8012  | 153         | YT-80787 | 356         | YT-8241  | 227; 338    | YT-83204 | 205         | YT-83334 | 206         | YT-83458 | 208         | YT-8449  | 203         |
| YT-7902 | 103         | YT-8020  | 357         | YT-80788 | 356         | YT-82421 | 227; 338    | YT-83205 | 205         | YT-83335 | 206         | YT-83480 | 208         | YT-8450  | 203         |
| YT-7903 | 103         | YT-8021  | 357         | YT-80789 | 356         | YT-8245  | 226; 337    | YT-83206 | 205         | YT-83336 | 206         | YT-83481 | 208         | YT-8451  | 203         |
| YT-7904 | 103         | YT-8022  | 357         | YT-80790 | 356         | YT-8250  | 226; 337    | YT-83207 | 205         | YT-83351 | 207         | YT-83482 | 208         | YT-8452  | 203         |
| YT-7905 | 103         | YT-8023  | 357         | YT-80791 | 356         | YT-8251  | 226; 337    | YT-83208 | 205         | YT-83352 | 207         | YT-83483 | 208         | YT-8453  | 203         |
| YT-7906 | 103         | YT-8024  | 357         | YT-80794 | 356         | YT-8252  | 226; 337    | YT-83209 | 205         | YT-83353 | 207         | YT-83484 | 208         | YT-8454  | 203         |
| YT-7907 | 103         | YT-8025  | 357         | YT-80795 | 356         | YT-8253  | 226; 337    | YT-83210 | 205         | YT-83354 | 207         | YT-83485 | 208         | YT-8455  | 203         |
| YT-7908 | 103         | YT-8026  | 357         | YT-80796 | 356         | YT-8254  | 226; 337    | YT-83211 | 205         | YT-83355 | 207         | YT-83486 | 208         | YT-8456  | 203         |
| YT-7909 | 103         | YT-8027  | 357         | YT-80797 | 356         | YT-8255  | 226; 337    | YT-83220 | 205         | YT-83356 | 207         | YT-83487 | 208         | YT-8457  | 203         |
| YT-7910 | 103         | YT-8028  | 357         | YT-80798 | 356         | YT-8256  | 226; 337    | YT-83221 | 205         | YT-83361 | 207         | YT-83488 | 208         | YT-8458  | 203         |
| YT-7911 | 103         | YT-8029  | 357         | YT-80799 | 356         | YT-8257  | 226; 337    | YT-83222 | 205         | YT-83362 | 207         | YT-83490 | 208         | YT-8459  | 203         |
| YT-7912 | 103         | YT-8030  | 357         | YT-80800 | 356         | YT-8258  | 226; 337    | YT-83223 | 205         | YT-83363 | 207         | YT-83491 | 208         | YT-8460  | 203         |
| YT-7913 | 103         | YT-8031  | 357         | YT-80801 | 356         | YT-8259  | 226; 337    | YT-83224 | 205         | YT-83364 | 207         | YT-83492 | 208         | YT-8461  | 203         |
| YT-7914 | 103         | YT-8032  | 357         | YT-80802 | 356         | YT-8260  | 226; 337    | YT-83225 | 205         | YT-83365 | 207         | YT-83493 | 208         | YT-8462  | 203         |
| YT-7915 | 103         | YT-8033  | 357         | YT-80811 | 356         | YT-8261  | 226; 337    | YT-83226 | 205         | YT-83366 | 207         | YT-83494 | 208         | YT-8463  | 203         |
| YT-7916 | 103         | YT-8034  | 357         | YT-80812 | 356         | YT-8262  | 226; 337    | YT-83227 | 205         | YT-83371 | 207         | YT-83495 | 208         | YT-8464  | 203         |
| YT-7917 | 103         | YT-80541 | 355         | YT-80813 | 356         | YT-8263  | 226; 337    | YT-83228 | 205         | YT-83372 | 207         | YT-83496 | 208         | YT-8465  | 203         |
| YT-7918 | 103         | YT-80542 | 355         | YT-80814 | 356         | YT-8264  | 226; 337    | YT-83229 | 205         | YT-83373 | 207         | YT-83497 | 208         | YT-8466  | 203         |
| YT-7919 | 103         | YT-80543 | 355         | YT-80815 | 356         | YT-8265  | 226; 337    | YT-83230 | 205         | YT-83374 | 207         | YT-83498 | 208         | YT-8480  | 204         |
| YT-7920 | 103         | YT-80544 | 355         | YT-80816 | 356         | YT-8266  | 226; 337    | YT-83231 | 205         | YT-83375 | 207         | YT-8350  | 203         | YT-8481  | 204         |
| YT-7921 | 103         | YT-80545 | 355         | YT-80817 | 356         | YT-8267  | 226; 337    | YT-83232 | 205         | YT-83376 | 207         | YT-8351  | 203         | YT-8482  | 204         |
| YT-7922 | 103         | YT-80546 | 355         | YT-80818 | 356         | YT-8268  | 226; 337    | YT-83233 | 205         | YT-83381 | 207         | YT-8352  | 203         | YT-8483  | 204         |
| YT-7923 | 103         | YT-80547 | 355         | YT-80819 | 356         | YT-8269  | 226; 337    | YT-83234 | 205         | YT-83382 | 207         | YT-8353  | 203         | YT-8484  | 204         |
| YT-7929 | 103         | YT-80548 | 355         | YT-80823 | 356         | YT-8270  | 226; 337    | YT-83235 | 205         | YT-83383 | 207         | YT-8354  | 203         | YT-8485  | 204         |
| YT-7930 | 103         | YT-80549 | 355         | YT-80824 | 356         | YT-8271  | 226; 337    | YT-83236 | 205         | YT-83384 | 207         | YT-8355  | 203         | YT-8486  | 204         |
| YT-7931 | 103         | YT-80552 | 355         | YT-80825 | 356         | YT-8272  | 226; 337    | YT-83237 | 205         | YT-83385 | 207         | YT-8356  | 203         | YT-85401 | 335         |
| YT-7932 | 103         | YT-80553 | 355         | YT-80826 | 356         | YT-8273  | 226; 337    | YT-83238 | 205         | YT-83386 | 207         | YT-8357  | 203         | YT-85402 | 335         |
| YT-7933 | 103         | YT-80554 | 355         | YT-80827 | 356         | YT-82742 | 226         | YT-83239 | 205         | YT-83390 | 207         | YT-8358  | 203         | YT-85403 | 335         |
| YT-7934 | 103         | YT-80555 | 355         | YT-80828 | 356         | YT-82743 | 226         | YT-83240 | 205         | YT-83391 | 207         | YT-8360  | 203         |          |             |
| YT-7935 | 103         | YT-80556 | 355         | YT-80829 | 356         | YT-82744 | 226         | YT-83251 | 206         | YT-83392 | 207         | YT-8361  | 203         |          |             |
| YT-7936 | 103         | YT-80557 | 355         | YT-80830 | 356         | YT-8300  | 328         | YT-83252 | 206         | YT-83393 | 207         | YT-8362  | 203         |          |             |
| YT-7937 | 103         | YT-80558 | 355         | YT-80831 | 356         | YT-8301  | 328         | YT-83253 | 206         | YT-83394 | 207         | YT-8363  | 203         |          |             |
| YT-7938 | 103         | YT-80559 | 355         | YT-80841 | 356         | YT-83016 | 328         | YT-83254 | 206         | YT-83395 | 207         | YT-8364  | 203         |          |             |
| YT-7939 | 103         | YT-80560 | 355         | YT-80842 | 356         | YT-8302  | 328         | YT-83255 | 206         | YT-83396 | 207         | YT-8365  | 203         |          |             |
| YT-7940 | 103         | YT-80572 | 355         | YT-80843 | 356         | YT-8303  | 328         | YT-83256 | 206         | YT-83397 | 207         | YT-8366  | 203         |          |             |

## PL

I. TOYA S.A. informuje, iż: 1) niniejszy katalog nie stanowi oferty w rozumieniu prawa cywilnego; 2) prezentowane w niniejszym katalogu artykuły mogą w rzeczywistości odbiegać od wskazanego na zdjęciach wzoru, w szczególności jeżeli chodzi o cechy zewnętrzne, tj. wielkość, kolor, sposób opakowania, ilość przedmiotów w opakowaniu; 3) nie ponosi odpowiedzialności za drobne różnice w sposobie pakowania czy właściwościach artykułów pozostających bez wpływu na jego przeznaczonego cel lub sposób użytkowania; 4) nie ponosi odpowiedzialności wynikającej z jakichkolwiek niedokładności lub nieścisłości, co do informacji zawartych w przedmiotowym katalogu; 5) nie ponosi odpowiedzialności za ewentualną szkodę powstałą w wyniku otrzymania towaru o innych właściwościach niż prezentowany na zdjęciach.

II. Pomimo najlepszych starań poczynionych przez TOYA S.A. nie może ona zagwarantować, iż informacje zawarte w niniejszym katalogu w pełni odpowiadają rzeczywistości.

III. Wszelkie decyzje podjęte na podstawie informacji zawartych w przedmiotowym katalogu podejmowane są na własne ryzyko osoby, która korzysta z tych informacji.

## GB

I. TOYA S.A. informs that: 1) the present catalogue does not constitute an offer as construed in the civil law; 2) the goods presented in the present catalogue may in fact differ from the models shown in the pictures, particularly as far as external properties are concerned, namely size, colour, packaging, number of items in the package; 3) the company will not be held responsible for small differences in packaging or properties of the goods, which do not affect the purpose or the exploitation of the tools; 4) the company will not be held responsible for any inaccuracies or imprecision regarding the information presented in the catalogue; 5) the company will not be held responsible for any damage caused by goods whose properties differ from those of the tools presented in the photographs.

II. In spite of all the efforts made by TOYA S.A., the company cannot guarantee the information contained in the present catalogue fully correspond to the reality.

III. Any decisions made on the basis of the information contained in the present catalogue will be made at the risk of the person who makes them using the aforementioned information.

## D

I. TOYA S.A. informiert, dass: 1) der vorliegende Katalog kein Angebot im zivilrechtlichen Sinne darstellt; 2) die im vorliegenden Katalog präsentierten Artikel in der Realität von den auf den Musterfotos gezeigten abweichen können, und zwar besonders dann, wenn es um äußere Eigenschaften geht, wie z.B. Größe, Farbe, Art der Verpackung, Anzahl der Gegenstände in der Verpackung; 3) sie keine Verantwortung für geringfügige Unterschiede bei der Verpackungsart oder den Eigenschaften der Artikel übernimmt, die ohne Auswirkungen auf seinen Bestimmungszweck oder die Art der Nutzung bleiben; 4) sie keine Verantwortung für irgendwelche Oberflächlichkeiten und Ungenauigkeiten bzgl. der im Sachkatalogkatalog enthaltenen Informationen übernimmt; 5) sie keine Verantwortung für eventuelle Schäden, die im Ergebnis des Erhalts der Ware mit anderen als auf den Fotos dargestellten Eigenschaften entstanden sind, übernimmt.

II. Trotz großer Bemühungen seitens TOYA S.A. kann die Firma nicht garantieren, dass die im vorliegenden Katalog enthaltenen Informationen voll der Realität entsprechen.

III. Sämtliche Entscheidungen, die auf der Grundlage der im Sachkatalog enthaltenen Informationen getroffen wurden, gehen auf das Risiko der Person, die diese Informationen benutzt.

## RUS

I. TOYA S.A. заявляет: 1) настоящий каталог не является торговым предложением с точки зрения гражданского законодательства; 2) изделия, представленные в настоящем каталоге, могут отличаться от образцов на снимках, особенно внешним видом, то есть размером, цветом, способом упаковки, количеством предметов в упаковке; 3) производитель не отвечает за мелкие отличия в способе упаковки или свойствах изделий, которые не влияют на предназначение или способ пользования изделиями; 4) производитель не отвечает за мелкие неточности в сведениях из предметного каталога; 5) производитель не отвечает за ущерб, нанесенный вследствие поставки товара, отличающегося параметрами от указанного на снимках.

II. Несмотря на все усилия в данном направлении, компания TOYA S.A. не гарантирует, что информация, метящаяся в настоящем каталоге, полностью отвечает действительности.

III. Риск, связанный с любыми решениями, принятыми на основании информации из предметного каталога, берут на себя лица, пользующиеся указанной информацией.

## CZ

I. TOYA S.A. informuje že: 1) tento katalog nepředstavuje nabídku ve smyslu občanského práva; 2) výrobky prezentované v tomto katalogu se mohou ve skutečnosti lišit od modelů uvedených na obrázcích, zejména co se týká vnějších znaků, tj. velikosti, barvy, způsobu balení, počtu předmětů v balení; 3) nenese odpovědnost za drobné rozdíly ve způsobu balení nebo ve vlastnostech výrobků, které nemají zásadní vliv na jejich určený účel nebo způsob používání; 4) nenese odpovědnost vyplývající z jakýchkoli nepřesností co do informací uvedených v předmětném katalogu; 5) nenese odpovědnost za případné škody vzniklé v důsledku obdržení zboží s jinými vlastnostmi, než je uvedeno na obrázcích.

II. Navzdory mimořádnému úsilí vynaloženému firmou TOYA S.A. tato nemůže garantovat, zda informace uvedené v tomto katalogu zcela odpovídají skutečnosti.

III. Veškerá rozhodnutí přijatá na základě informací uvedených v předmětném katalogu jsou přijímána na vlastní riziko osoby, která tyto informace využívá.

## H

I. A TOYA S.A. tájékoztatja, hogy: 1) a jelen katalógus a polgári jog szerint nem kereskedelmi ajánlat; 2) a jelen katalógusban bemutatott árucikkek a valóságban eltérhetnek a képeken látható mintáktól, különösen a külső tulajdonságok, mint a méret, szín, csomagolási mód, a csomagban lévő tárgyak száma tekintetében; 3) nem vállal felelősséget a csomagolás módjában vagy az árucikkek olyan tulajdonságaiban történt változtatásokért, amelyek nem befolyásolják lényeges módon annak rendelkezését vagy a felhasználás módját; 4) nem vállal felelősséget a jelen katalógusban lévő információk pontatlanságáért; 5) nem vállal felelősséget azokért az esetleges károkért, amik az árucikkek a fényképeken látható tulajdonságoktól eltérő tulajdonságokkal történő leszállításából erednek.

II. A TOYA S.A. minden igyekezete ellenére nem tudja garantálni, hogy a jelen katalógusban található információk teljes egészében megfelelnek a valóságnak.

III. A tárgyi katalógusban található információk alapján meghozott bármilyen döntés annak a személynek a rizikója, aki ezeket az információkat felhasználja.

## RO

I. TOYA S.A. informează că: 1) prezentul catalog nu constituie ofertă în înțelesul dreptului civil; 2) articolele prezentate în prezentul catalog se pot diferi față de mostrele din fotografiile, în special aspectul exterior, adică mărimea, culoarea, modul de ambalare, cantitatea obiectelor în ambalaj; 3) nu-și asumă răspunderea referitor la mici diferențe la modul de ambalare sau la articolele al căror proprietăți nu au influență referitor la destinația sau modul lor de utilizare; 4) nu-și asumă răspunderea referitor la orice inexactitate sau imprecizie, datorită informațiilor cuprinse în catalogul respectiv; 5) nu-și asumă răspunderea referitor la o eventuală pagubă ca urmare a primirii marfei cu alte proprietăți decât cele prezentate pe fotografii;

II. Cu toate strădanile TOYA S.A., firma nu poate garanta că, informațiile din prezentul catalog corespund realității;

III. Orice decizie preluată în baza informațiilor cuprinse în catalogul respectiv, sunt preluate pe riscul și răspunderea persoanei care a făcut folos de aceste informații.

## E

I. TOYA S.A. comunica lo siguiente: 1) el presente catálogo no constituye una oferta, en el sentido que la noción adquiere en la ley civil; 2) los artículos presentados en el presente catálogo pueden en realidad diferir de los modelos indicados en las fotografías, especialmente en cuanto a sus propiedades externas, es decir el tamaño, el color, el empaque o la cantidad de los objetos en el empaque; 3) la empresa no se hace responsable por pequeñas diferencias en cuanto al empaque o las propiedades de los artículos, siempre y cuando estas diferencias no afectan el propósito o el modo de operación de las herramientas; 4) la empresa no se hace responsable por ninguna imprecisión en cuanto a la información presentada en el presente catálogo; 5) la empresa no se hace responsable por ningún daño que surja del hecho de que los artículos recibidos difieran de los artículos presentados en las fotografías en cuanto a sus propiedades.

II. A pesar de los mejores intentos de parte TOYA S.A. la empresa no puede garantizar que la información presentada en el presente catálogo corresponda completamente a la realidad.

III. Todas las decisiones tomadas en base a la información presentada en el presente son responsabilidad de la persona que recurra a la dicha información.

# SKLEPY PATRONACKIE

**DOLNOŚLĄSKIE BOLESŁAWIEC** JTJ, ul. Kosiby 68a, ☎ 75/732 45 54; MAJSTER, ul. Bolesława Kubika 1, ☎ 75/734 18 00; **BYSTRZYCA KŁODZKA** NARZĘDZIAK, ul. Strażacka 9c, ☎ 74/644 13 40; **DZIERŻONIÓW** IF, ul. Batalionów Chłopskich 19, ☎ 74/831 14 53; **JAWOR** ART-MET, ul. Wrocławska 35, ☎ 76/870 68 12; **JELENIA GÓRA** KOLASKA, ul. Piłsudskiego 47, ☎ 75/753 36 53; **KŁODZKO** AGROL, ul. Objazdowa 1, ☎ 74/865 23 00; NARZĘDZIAK, ul. Witosa 16, ☎ 74/867 01 40; **KUDOWA ZDRÓJ** HAMER, ul. Nad Potokiem 40, ☎ 74/866 48 35; **LIPIANY** AGNES24, Autostrada A4, Zjazd Lipiany (kier. Olszyna), ☎ 519 66 73 91; **ŁAGIEWNIKI** JAŚMA, ul. Kłodzka 8, ☎ 74/893 93 45; **MILICZ** ROLBUD, ul. Osadnicza 6, ☎ 71/384 24 20; **MILKOWICE** KUBA, Jakuszków 43, ☎ 76/857 02 40; **NOWA RUDA** GO-MAR, ul. Kolejowa 13, ☎ 74/872 22 89; **OBORNIKI ŚLĄSKIE** MASTERMET, ul. Skłodowskiej 32, ☎ 71/387 04 11; **OLEŚNICA** ROLMET, ul. Wąły Jagiellońskie 9-10, ☎ 71/399 99 03; ŚWIERK, ul. Wojska Polskiego 47a, ☎ 71/314 74 62; WKREŃ, ul. 3 Maja 12, ☎ 71/798 08 80; **OLAWA** KOŚCIELAK, ul. 3 Maja 20a, ☎ 71/313 36 37; **POLKOWICE** INSTALMET, ul. Mickiewicza 3, ☎ 76/845 02 20; **TRZEBNICA** ARTYKUŁY METALOWE LINIAK, ul. Miłicka 28, ☎ 71/312 19 55; **WOLÓW** ŚRUBKA, ul. Trzebnicka (Galeria przy rondzie), ☎ 508 91 06 76; **WROCLAW** DOMIX, ul. Buforowa 2, ☎ 71/336 10 11; JASNY GWINT, ul. Legnicka 21, ☎ 71/355 51 54; JATO, ul. Gajowicka 95, ☎ 71/361 97 02; WDA, ul. Borowska 258, ☎ 71/373 12 51; **ZĄBKOWICE ŚLĄSKIE** DANROL, ul. Waryńskiego 13, ☎ 74/815 60 17; ROLZBYT, ul. Waryńskiego 13, ☎ 74/810 05 22; **ZGORZELEC** AGNES24, ul. Żarska Wieś 2, ☎ 504 25 26 04; **ZIĘBICE** FIRGANG, ul. Gliwicka 10, ☎ 74/819 18 49

**KUJAWSKO-POMORSKIE BYDGOSZCZ** MOTO-SAM-OIL, ul. Flisacka 23, ☎ 52/581 18 38; SADAMET, ul. Grudziądzka 25, ☎ 52/582 10 11; WULKAN, ul. Planu 6-letniego 3b, ☎ 52/375 54 50; EMAX, ul. Pięknogórska 2, ☎ 52/347 28 30; **KOWAL** PAMET, ul. Kollataja 26a, ☎ 54/284 24 22; **LIPNO** KAROL, ul. Cegielnia 2b, ☎ 54/287 25 79; **SZUBIN** DUBIEL, ul. Kościuszki 3, ☎ 52/384 35 38

**LUBELSKIE HRUBIESZÓW** ROLBUD, ul. Kolejowa 12c, ☎ 602 39 27 34; **KRASNOSTAW** GRZEGORZ, ul. Stanisława Augusta Poniatowskiego 9, ☎ 606 68 41 91; **KRAŚNIK** SALON TECHNIKI NR 4, al. Niepodległości 7b, ☎ 81/825 45 51; **LUBLIN** ILCZUK, ul. Witosa 3, ☎ 81/745 88 66; ZAMET, ul. Kasprowicza 112, ☎ 81/746 09 69; **ŁĘCZNA** DAJANA, ul. Podzamcze 222, ☎ 504 08 87 10; **ŁUKÓW** DUET, ul. Żelechowska 11, ☎ 25/798 22 09; MICHAŁ WAROWNY, ul. Trentowskiego 13b, ☎ 25/798 82 01; **MIEDZYRZEC PODLASKI** ROLMET, ul. Brzeska 25, ☎ 83/371 68 23; **OPOLE LUBELSKIE** BSS COMPANY, ul. Lubelska 13, ☎ 665 65 51 21; **PARCZEW** KINGMETOIL, ul. 11-go Listopada 70, ☎ 83/354 12 19; **PULAWY** ASMET, ul. Lubelska 53, ☎ 81/887 72 73; PAWŁĘDZIO & OLSZOWY, ul. Dęblińska 6a, ☎ 81/888 31 01; **RADZYŃ PODLASKI** AGRO-TECH, ul. Międzyrzeczka 151, ☎ 83/352 13 22; **RYKI** TECHEXPERT, ul. Przemysłowa 2, ☎ 509 77 47 17; **ŚWIDNIK** EMENEF, ul. Kosynierów 22, ☎ 603 60 19 04; **URZĘDÓW** NOWACZYŃSCY, Rynek 16, ☎ 81/822 58 10; **WERBKOWICE** HYDROMET, ul. Zamojska 2a, ☎ 84/657 26 57; **ZAMOŚĆ** ASMET, ul. Przemysłowa 2c, ☎ 84/638 19 68; REMAL, ul. Kilińskiego 3, ☎ 84/627 57 10

**LUBUSKIE DREZDENKO** JGM, ul. Poznańska 4, ☎ 95/762 91 09; **GORZÓW WIELKOPOLSKI** KARO, ul. Olimpijska 36, ☎ 95/720 42 90; **KROSNO ODRZAŃSKIE** BUDMAX, ul. Bohaterów WP 58, ☎ 683 59 22 40; **ŁĘKNICA** ROLMET, ul. Wojska Polskiego 5, ☎ 68/362 41 25; **MIEDZYRZEC** KLEMENCZAK, ul. Reymonta 4, ☎ 95/741 89 24; **NOWA SÓL** ARTYKUŁY METALOWE MONIAK, ul. Okrężna 10, ☎ 68/387 21 33; **RZEPIN** FARYS, ul. Zielona 1, ☎ 95/759 59 09; **SKWIERZYNA** HASTER, ul. Arciszewskiego 14, ☎ 95/717 64 00; **ŚLUBICE** MASTER, ul. Kopernika 23a, ☎ 794 52 05 57; **SULECHÓW** ROLMET, pl. PCK 4, ☎ 68/385 28 62; **ŻARY** ROLMASZ, ul. Okrzei 9, ☎ 68/363 10 21

**ŁÓDZKIE GRABÓW** MARPOL, ul. Ogrodowa 52a, ☎ 63/273 41 40; **KONSTANTYNÓW ŁÓDZKI** OD A DO Z, ul. Żeromskiego 2, ☎ 42/211 11 92; **KUTNO** TYTAN, ul. Spółdzielcza 7, ☎ 24/254 02 55; **ŁÓDŹ** AUTOTOP, ul. Traktorowa 119, ☎ 42/652 68 52; LANDHEN, ul. Sieradzka 1, ☎ 42/639 52 90; **PIOTRKÓW TRYBUNALSKI** PIOMOT, ul. Roosevelta 16a, ☎ 44/647 69 19; **RAWA MAZOWIECKA** KALG-MET, ul. Reymonta 7a/13, ☎ 46/ 814 70 50; **SIERADZ** BIMEX, ul. Organizacji Katyń 13, ☎ 43/822 61 05; **TOMASZÓW MAZOWIECKI** GRAD, ul. Główna 67a, ☎ 44/726 04 83; **WIELUŃ** METALOWIEC, ul. Reformacka 9, ☎ 43/843 02 97; **ZGIERZ** BMP, ul. Ozorkowska 48, ☎ 509 56 37 01

**MAŁOPOLSKIE BRZESZCZE** ELEKTROSPAW, ul. Dworcowa 37, ☎ 32/212 10 28; **OŚWIĘCIM** ŚRUBOMET, ul. Leszczyńskiej 9, ☎ 33/843 00 78; **SKAWA** POTOCZAK, Skawa 625, ☎ 18/269 20 62

**MAZOWIECKIE GOSTYNIN** TYTAN, ul. Kutnowska 74a, ☎ 24/235 84 22; **GOWOROWO** PERFECT, Goworówek 44a, ☎ 29/761 40 80; **GRÓJEC** MECENAS, ul. Armii Krajowej 13, ☎ 508 16 34 40; **JANKI** TECH-MET, ul. Wspólna 5, ☎ 22/720 49 74; **KONSTANCIN-JEZIORNA** REMONT, Chylice, ul. Starochylicka 26, ☎ 22/757 23 28; **LEGIONOWO** AKROS, ul. Handlowa 15, ☎ 22/784 18 98; EXTRADOM, ul. Piłsudskiego 27, ☎ 22/784 44 41; **MIŃSK MAZOWIECKI** GAŁĄZKA, ul. Warszawska 117, ☎ 25/758 65 44; **OTWOCK** ADAMET, ul. Mysia 5/7, ☎ 22/788 55 42; **PRUSZCZÓW** ANTER, ul. Poznańska 50, ☎ 22/759 86 11; METALZBYT-HURT, ul. Helenowska 26a, ☎ 694 48 76 52; **RADOM** MaGoPol, ul. Witosa 67, ☎ 48/333 03 84; **SIEDLCE** SPINMET, ul. Magazynowa 10, ☎ 25/633 57 57; **WISKITKI** BINPOL, ul. Błońska 1, ☎ 46/856 73 93

**OPOLSKIE BRZEG** WDW, ul. Dzierżonia 4, ☎ 77/416 59 61; **KLUCZBORK** EU-CO, ul. Paderewskiego 2a, ☎ 77/447 12 30; **NYSA** KRAB, ul. Bolesława Śmiałego 5, ☎ 77/409 08 80; **PACZKÓW** AUTO-CZEŚCI SKOTNICKI, ul. Słowackiego 2, ☎ 77/431 66 92; **PRASZKA** FAM-GAZ, ul. Kościuszki 7, ☎ 34/359 11 65; **PRUDNIK** ADBD, ul. Prążyńska 17, ☎ 77/436 38 15; **ŚWIERCZÓW** DAWMAR, ul. Brzeska 68, ☎ 77/419 23 15

**PODKARPACKIE JAROSŁAW** ELKUR, ul. 3-go Maja 98b, ☎ 16/621 68 82; **JASŁO** OGRÓD, ul. Lwowska 24b, ☎ 13/445 81 60; **KROSNO** S8, ul. Pużaka 49, ☎ 13/420 48 36 wew. 12; **ŁĘKI GÓRNE** A-Z, Łęki Górne 237a, ☎ 14/672 51 55; **PRZYSIEKI** DECO-EXPERT, Przysieki, ☎ 503 98 77 98; **STAŁOWA WOLA** SALON TECHNIKI NR 5, ul. Okulickiego 56c, ☎ 15/842 53 90; **TARNOBRZEG** SALON TECHNIKI NR 1, ul. Kwiatkowskiego 14, ☎ 15/822 99 22

**PODLASKIE BIAŁYSTOK** AW NARZĘDZIA, ul. Sławińskiego 8, ☎ 85/663 14 10; LUMINAR, ul. Ciołkowskiego 88, ☎ 85/873 98 87; **CHOROSZCZ** PLUS, ul. Powstania Styczniowego 26b, ☎ 85/719 26 84; **HAJNÓWKA** METALOWY, ul. 11 listopada 1, ☎ 85/682 22 11

**POMORSKIE CHOJNICE** DREMET, ul. Drzymały 14, ☎ 52/395 16 04; **CZŁUCHÓW** EKODOMAR, ul. Batorego 18, ☎ 59/834 50 51; **GDAŃSK** FIGEL AUTO NARZĘDZIA, ul. Chrzanowskiego 36a, ☎ 58/341 04 53; METALMOT, al. Grunwaldzka 487, ☎ 58/552 03 01; ROTOR 1, ul. Łąkowa 37, ☎ 58/301 41 39; **GDYNIA** KRZEM, ul. Wielkopolska 23, ☎ 58/664 84 87; **KARTUZY** BIM, ul. Gdańska 28, ☎ 58/685 42 08; **KOŚCIERZYNA** MARKET NARZĘDZIOWY, ul. Przemysłowa 7f, ☎ 58/680 25 25; **PRUSZCZ GDAŃSKI** KARMEN, ul. Krótka 22, ☎ 58/683 41 45; **ŚLUPSK** AUTOMAX P&S, ul. Przemysłowa 10, ☎ 59/840 06 98; MAKRO-HURT, ul. Poznańska 79, ☎ 59/842 50 32; **SOPOT** MIKROENERGETYKA, al. Niepodległości 712, ☎ 58/555 74 68; **STAROGARD GDAŃSKI** MARKET BUDOWLANY SPUTNIK, ul. Zblewska 9, ☎ 58/560 19 99; **TCZEW** CHEMTECH, ul. 30 Stycznia 42c, ☎ 58/532 44 36; **WEJHEROWO** DOMATOR, ul. 1 Brygady Pancerniej WP 86b, ☎ 58/677 26 27

**ŚLĄSKIE BIELSKO-BIAŁA** METALZBYT, ul. Bardowskiego 2 (wjazd od Leszczyńskiej), ☎ 33/498 95 25; **GLIWICE** MrGWINT, ul. Orlickiego 15, ☎ 32/337 35 70; NEDPOL, ul. Pszczynska 306, ☎ 32/331 75 10; **KATOWICE** BARBARA, ul. Sikorskiego 41, ☎ 32/785 91 16; **MYSZKÓW** AUTO WNUK, ul. Słowackiego 16, ☎ 502 57 08 95; **PORAJ** STALMET, ul. Armii Krajowej 22, ☎ 34/314 77 42; **SOSNOWIEC** ŚRUB-TECH, ul. Piękna 2a, ☎ 32/291 35 35; **TYCHY** BARBARA, ul. Mikołowska 130, ☎ 32/216 83 36; BARBARA, ul. Kościuszki 14, ☎ 32/780 28 84; **ZAWIERCIE** MOTO-KRIS, ul. Obrońców Poczty Gdańskiej 57, ☎ 32/670 82 50; **ŻYWIEC** SPAW-TECH, ul. Wesola 41, ☎ 880 13 87 16

**ŚWIĘTOKRZYSKIE SANDOMIERZ** SALON TECHNIKI NR 3, ul. Przemysłowa 8, ☎ 15/644 58 48; **STASZÓW** SALON TECHNIKI NR 2, ul. Koszarowa 3, ☎ 15/864 47 81; **WŁOSZCZOWA** OL-MAR, ul. Sienkiewicza 30, ☎ 41/394 23 30

**WARMIŃSKO-MAZURSKIE ELBLĄG** AGROS B, ul. Grochowska 57, ☎ 55/232 89 22; AKCES, ul. Hodowlana 10, ☎ 55/232 11 68; LEGRAMET, ul. Grunwaldzka 2d, ☎ 55/641 84 84; **ELK** JARMEK, ul. Słoneczna 3a, ☎ 87/610 88 90; **KĘTRZYN** BOMA, ul. Chopina 18, ☎ 89/752 52 37; **OLECKO** AGROMASZ, ul. Zamostowa 10, ☎ 87/523 00 20; **OSTRÓDA** BART, Kajkowo, ul. Świetlińska 3, ☎ 89/642 34 80; **SZCZYTNO** EL-MARK, ul. Pasymska 29, ☎ 89/624 62 52

**WIELKOPOLSKIE DOBRZYCA** AMAR, Rynek 4, ☎ 62/735 89 87; **GNIĘZNO** ŻELAZNY, ul. Podkomorska 5, ☎ 61/425 70 94; **GRODZISK WIELKOPOLSKI** MAKING, ul. Chopina 5, ☎ 728 95 88 30; MAKING, ul. Poznańska 69, ☎ 72/895 88 30; **KALISZ** KALMER, ul. Miedziana 2, ☎ 62/764 12 56; WELA, ul. Skarszewska 72, ☎ 62/760 16 66; **KEPNO** METALOWIEC, ul. Rzeźnicza 14, ☎ 62/782 26 50; **KOŁO** PROMA, ul. Sienkiewicza 8, ☎ 63/261 66 85; **LIPNO** HURTOWNIA NARZĘDZI, ul. Spółdzielcza 1, ☎ 655 34 06 09; **MIEDZYCHÓD** ELMAT, ul. Chrobrego 24, ☎ 95/748 28 58; **MUROWANA GOŚLINA** M-DACH, ul. Gnieźnieńska 40, ☎ 517 23 12 28; **NOWE SKALMIERZYCE** ROLNIK, ul. Powstańców Wielkopolskich 15, ☎ 62/762 12 13; **OSTRORÓG** KACZMAREK, ul. Pniewska 30, ☎ 61/291 65 64; **PLESZEW** TECHNIK, ul. Sopałowicza 2, ☎ 62/742 23 42; **PNIEWY** KACZMAREK, ul. Wroniecka 17a, ☎ 61/291 65 64; **POZNAŃ** ADAMEX, ul. Głogowska 153, ☎ 61/650 00 05; ELMAR, Luboń, ul. Przy Autostradzie 9, ☎ 61/ 899 51 50; HURTOWNIA WIELOBRANŻOWA, ul. Przemysłowa 25, ☎ 61/833 53 01; WALMAR-SPALUS, Wysogotowo, ul. Wierzbowa 177, ☎ 61/652 52 30; **ROKIETNICA** FALCON9, ul. Szkolna 15a, ☎ 795 28 03 32; **SIEDLEC** DELBUD, ul. Zbąszyńska 18, ☎ 683 84 81 33; **SZAMOTUŁY** PARTNER, ul. Sportowa 5, ☎ 61/292 25 90; **ŚRODA WIELKOPOLSKA** BAMET, ul. Harcerska 12b, ☎ 61/285 03 78; **TARNOWO** PODGÓRNE NOWEX, ul. Poznańska 81, ☎ 61/816 41 00; **TRZCIANKA** MAC, ul. Kopernika 1, ☎ 67/216 62 10; **WIELEŃ** FARMLEK, ul. Nowe Miasto 40, ☎ 61/256 14 60; **WRZEŚNIA** BIMEX, ul. Kościuszki 14, ☎ 61/436 62 83

**ZACHODNIOPOMORSKIE DRAWSKO POMORSKIE** GAZ-TOM, ul. Złocieniecka 2, ☎ 606 61 61 42; **KAMIENŃ POMORSKI** HYDROELEKTROMET, ul. Mieszka I 5b, ☎ 91/382 08 96; **NOWOGARD** DEZAR, ul. 15 Lutego 10, ☎ 91/392 12 20; **STARGARD SZCZECIŃSKI** AMATE, ul. Bema 5, ☎ 91/573 86 76; **SZCZECINEK** KITA, Hala Targowa, ul. Wiśniowa, ☎ 662 15 85 64



## IMPORTER

TOYA S.A.  
ul. Sołtysowicka 13-15  
51-168 Wrocław  
☎ (+48 71) 32 46 200  
fax: (+48 71) 32 46 370  
sales@yato.pl (sale)  
export@yato.pl (export)  
import@yato.pl (import)

ODDZIAŁ WARSZAWSKI  
Teren ProLogis Park Nadarzyn  
al. Kasztanowa 160  
05-831 Młochów k. Warszawy  
☎ (+48 22) 73 82 800  
☎ (+48 22) 73 82 828  
sales@yato.pl (sale)  
export@yato.pl (export)

## AUTORYZOWANI DYSTRYBUTORZY

### Polska

ABA Jerzy Szczęch  
ul. Prosta 12  
85-150 Bydgoszcz  
☎ (+48 52) 37 16 883  
☎ (+48 52) 37 00 312  
aba@aba.biz.pl

INTER-GRAHEN  
ul. Kartuska 240a  
80-122 Gdańsk  
☎ (+48 58) 32 01 130  
fax: (+48 58) 32 01 131  
hurtownia@inter-grahen.com.pl

MAX TOOL II  
ul. Wschodnia 3  
05-090 Raszyn  
☎ (+48 22) 71 61 425  
fax.: (+48 22) 71 61 426  
maxtool@maxtool.pl

AW-NARZĘDZIA  
Walenty Androsiuk  
ul. Sławińskiego 6  
15-349 Białystok  
☎ (+48 85) 74 80 162  
biuro@aw-narzedzia.com.pl

KLIMAR SP. J.  
ul. Wrocławska 3  
52-271 Suchy Dwór k. Wrocławia  
☎ /fax: (+48 71) 31 64 007  
☎ /fax: (+48 71) 31 64 008  
klimar\_narzedzia@poczta.fm

TOYA STANMAR  
ul. Kwiatkowskiego 14  
39-400 Tarnobrzeg  
☎ (+48 15) 82 29 922  
fax: (+48 15) 822 99 23  
toya@stanmar.pl

DEJOT  
Jerzy Duda  
ul. Częstochowska 25  
62-800 Kalisz  
☎ (+48 62) 76 72 686  
dejot90@wp.pl

KOMET SP. J.  
ul. Karowa 48  
08-119 Siedlce  
☎ (+48 25) 63 28 016  
komet\_narzedzia@interia.pl

### Germany / Niemcy

WESTP GMBH  
Werkzeuggroßhandel,  
Dieselstrasse 12C-D,  
D-50259 Pulheim,  
☎ (+49) 2238 4787 270;  
fax.: (+49) 2238 4787 262,  
info@westp.de

### Romania / Rumunia

TOYA ROMANIA S.A.,  
Sos. Odăi Nr. 109-123,  
Sector 1, Bucureşti,  
☎ 0040 031 710 8692,  
office@yato.ro

### Czech Republic and Slovakia / Czechy i Słowacja

COMPASS,  
Pražská 17,  
250 81 Nehvizdy,  
☎ 420 326 702 532, 420 603 464 781,  
naradi-yato@compass.cz

### Singapore / Singapur

JET Machinery Pte Ltd.,  
10, Admiralty Street,  
#03-61, North Link  
Building,  
757695 Singapore

### Malaysia / Malezja

JET Machinery Sdn. Bhd.,  
No. 6M, Jalan PJS 11/16,  
Bandar Sunway,  
46150 Petaling Jaya, Selangor

### South Africa / Republika Południowej Afryki

L&G TOOLS AND MACHINERY DIST. LTD,  
6 KYALAMI ROAD, WESTMEAD,  
Pinetown 3610, Durban

### United Arab Emirates / Zjednoczone Emiraty Arabskie

SPEEDEX INTERNATIONAL LLC,  
P.O. BOX: 13460,  
Near Rafee Hotel,  
Naif Road, Deira, Dubai

### Caribbean / Wyspy Karaibskie

August Harms  
GmbH & Co KG  
Moenckebergstr. 17  
20095 Hamburg  
Germany  
☎ (+49) 4032 5544 0  
fax.: (+49) 4032 5544 99  
mail@augustharms.de